

TALEA - ODEA

SERVICE MANUAL

Revision 3 / January 2009

All parts of this document are the property of **Saeco International Group**. All rights reserved. The manufacturer shall not accept responsibility for possible errors or omissions in this document. Any reproduction or use by third parties is prohibited without the prior written approval of the manufacturer or through an agreement clause.

Table of contents

	Page
1. Introduction	
1.1 Documents required	1
1.2 Tools and resources	1
1.3 Materials	1
1.4 Safety precautions	1
1.5 Model overview	2
1.6.1 External appliance components	3
1.6.2 Internal appliance components	4
2. Technical specifications	1
3. Operating	
3.1 User interfaces	1
3.1.1 Odea Go	2
3.1.2 Odea Giro, Talea Giro	3
3.1.3 Talea Giro Plus	3
3.1.4 Talea Ring, Ring Plus	4
3.1.5 Talea Touch	8
3.2 Use, cleaning, maintenance	12
3.3 Messages - Troubleshooting	13
4. Functional principles	
4.1.1 Odea Go water system	1
4.1.2 Talea, Odea Giro water system	2
4.2 Solenoid valve, multi-way valve	3
4.3 Hot water / steam faucet	4
4.4 Coffee cycle	5
4.5 Brewing unit's gear mechanism	6
4.6 Temperature sensor (control)	6
4.7 SBS	7
4.8 Coffee grinder	8
4.9 Dosing quantity control, coffee grinder blockage when machine is low on beans	8
4.10 Autodose (automatic dosing quantity control)	9

Table of contents

	Page
4. Functional principles	
4.11 Water level detection of fresh water tank	10
4.12 Limescale filter	10
4.13 Water level detection of residual water tray	11
4.14 "Empty dreg drawer" message	11
4.15 Descaling request	12
4.16 Electronical configuration (DIP-switch setting)	12
4.17 Cup lift	13
4.18 Milk Island	13
5. Service modality	
5.1.1 Test mode - Talea Giro and Odea	1
5.1.2 Special function mode - Talea Giro and Odea	2
5.2.1 Test mode - Talea Ring and Ring Plus	3
5.2.2 Diagnosis menu - Talea Ring and Ring Plus	6
5.3.1 Test mode - Talea Touch	9
5.3.2 Diagnosis menu - Talea Touch	13
5.4 Error messages	17
6. Standard controls	
6.1 Repair plan	1
6.2 Service plan	1
6.3 Final control	2
7. Disassembly	
7.1 SBS / dispenser	1
7.2 Housing	1
7.3 Electronics	3
7.4 Boiler pin	3
7.5 Gear motor device	4
7.6 Boiler	5

Table of contents

	Page
7. Disassembly	
7.7 Solenoid valve / multi-way valve	6
7.8 Pump	7
7.9 Hose connections (assembly)	7
7.10 Coffee grinder	9
7.11 Grinders	10
7.12 Adjustment of coffee grinder	11
7.13 Cup lift	12
8. Notes	1
9. Water system diagrams	
Odea Go	
Odea Giro Plus, Giro	
Talea	
10. Wiring diagrams	
Odea Go	
Odea Giro	
Talea Giro Plus	
Talea Ring	
Talea Ring Plus	
Talea Touch Plus	

CHAPTER 1

INTRODUCTION

1.1 Documents required

The following documents are needed for repair work:

- Instruction booklet for the related model
- Technical documentation for the related model

1.2 Tools and resources

As well as the standard equipment, the following is required:

Pieces	Description	Comment
1	Special screwdriver	Torx T 10
1	Pliers for Oetiker clamps	
1	Tester CC - A - VDC	
1	Digital temperature meter	Temperature range > 150°C
1	SSC (Saeco Service Center)	Interface for programming

1.3 Materials

Description	Comment
Thermal conductance paste	Temperature resistance > 200°C
Descaler	Saeco descaler
Fat solvent	Personal choice
Silicone grease	Food-safe

1.4 Safety precautions

Read the instruction booklet before working on the machine.
Observe all applicable standards related to the repair of electrical appliances.

Always disconnect the power plug from the mains before carrying out repairs. Simply turning off the machine's main switch is not an adequate safety precaution.

This appliance is rated as protection class I.
The protective measures must be checked after completing all work.

1.5. Model overview



Model Option	Odea			Talea			
	Go	Giro	Giro Plus *	Giro Plus	Ring	Ring Plus	Touch Plus
Touchscreen							x
Display 2 x 24						x	
Display 2 x 16					x		
LED display	x	x	x	x			
SBS				x	x	x	x
Cup warmer (active)						x	x
Cup lift (electric)						x	x
Milk Island (optional)				x	x	x	x
Rapid Steam		x	x	x	x	x	x
Powder shaft				x		x	x
Automatic descaling cycle				x		x	x

*Painted parts

1.6.1. External appliance components

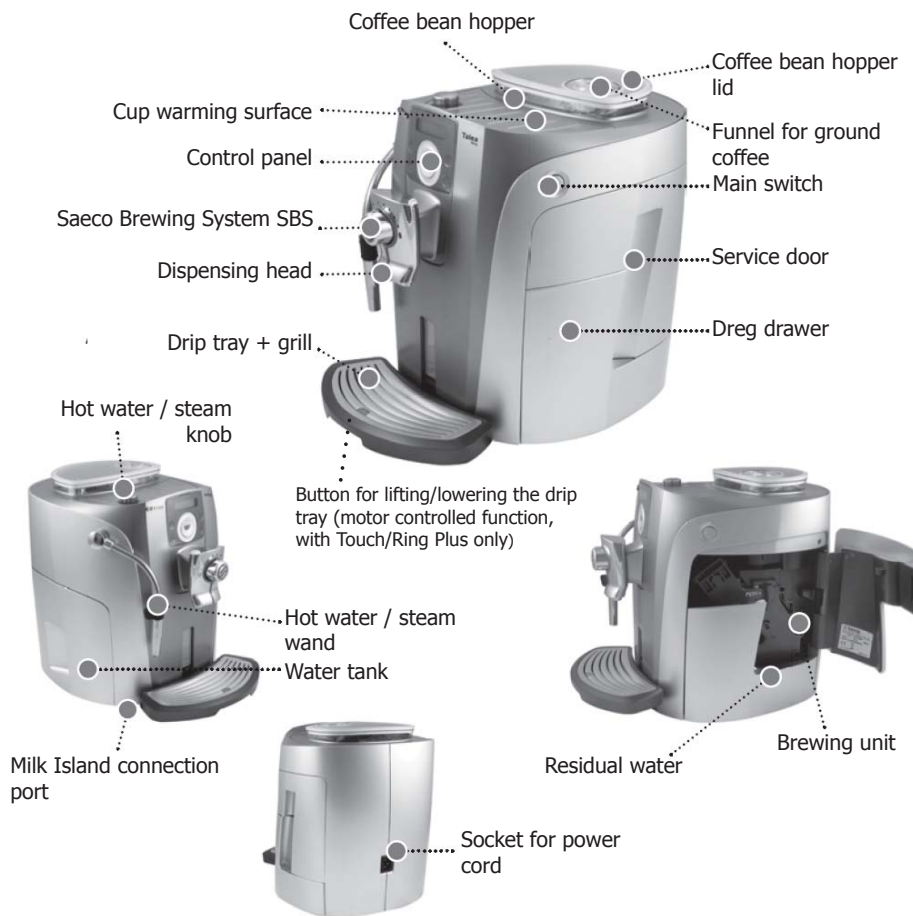

1.6.2. Internal appliance components

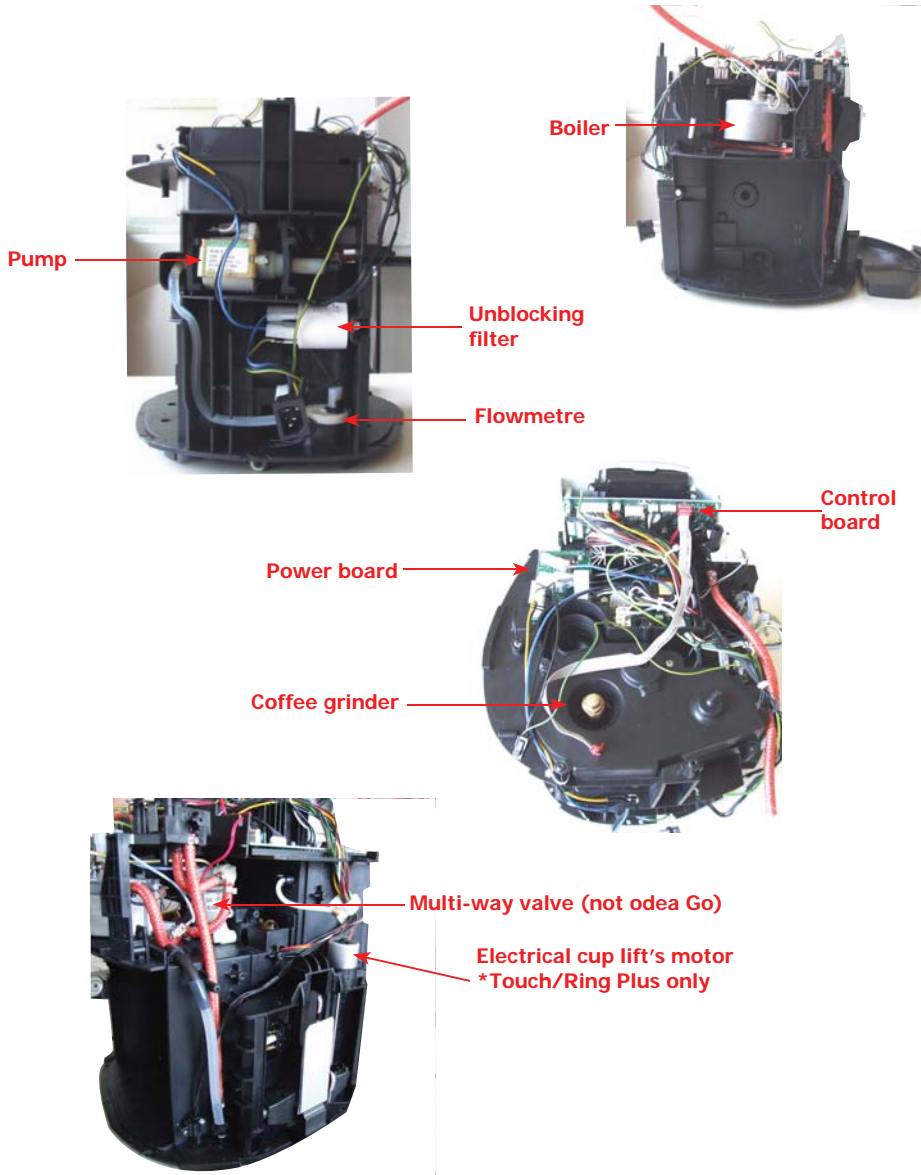

CHAPTER 2 TECHNICAL SPECIFICATIONS

Technical specifications

Connection values / power consumption:	230 V~, 50/60 Hz, 1500 W
Temperature control:	Temperature sensor (NTC, 20°C approx. 61 kOhm)
Safety equipment:	2 safety thermostats, can resist 175°C
Power output of stainless boiler:	1300 W - to dispense coffee, hot water and steam
Electrical cup lift *Talea Touch and Ring Plus only	Stepping motor 24VDC
Tank water level and residual water tray sensor	Capacitive sensor
Gear motor:	DC motor with 2 rotating directions (24VDC)
Actively heated cup warmer: *Talea Touch and Ring Plus only	PTC control
Pump:	Ulka reciprocating piston type pump with thermal safety 100°C 48 W, 230V, 50 Hz, Type EP5 approx. 13-15 bar
Safety valve:	Opens at approx. 18-20 bar
Water filter:	in tank
Coffee grinder:	DC motor with ceramic grinders
Multi-way valve:	15 W
Coffee dose control	Hall sensor - pulse control. Adjustable coffee dosage from approx. 7 - 10.5 g set via program.
Power consumption:	During heating phase - approx. 5.6 A
Dimensions: W x H x D in mm:	300/375/410
Weight:	approx. 10 kg
Water tank capacity:	approx. 1.7 l.
Coffee container filling capacity	approx. 250g coffee beans
Dreg drawer capacity	14
Continuous-flow heater capacity:	approx. 10 ccm
Water circuit filling time:	approx. 15 seconds for first filling cycle
Heating time:	approx. 45 seconds
Dispensed drink temperature:	approx. 73°C - 83°C
Grinding time:	approx. 8-10 seconds

CHAPTER 3 OPERATING

3.1. User interfaces

3.1.1 Odea Go

"Appliance ready" LED:

- **Permanently on:** The appliance is ready for use.
- **Flashing:** The appliance has to finish the heating-up phase.

"Empty dreg drawer" LED:

- **Permanently on:** Empty the dreg drawer. The appliance must be switched on for this procedure.

Control to set how much coffee is dispensed into the cup.

Coffee dispensing key:

- **Flashing slowly:** 1 coffee selected (key pressed once).
- **Flashing rapidly:** 2 coffees selected (key pressed twice).



"Hot water" key:

- **On:** The appliance dispenses steam.
- **Off:** The appliance dispenses hot water.



Alarm LED:

- **Permanently on (one or more causes):** No coffee left, water tank is empty, empty the residual water tray is full (in this case the dreg drawer also has to be emptied to prevent problems).
- **Flashing slowly (one or more causes):** Brewing unit is missing, dreg drawer has not been inserted, coffee container cover has not been inserted, service door is open, rotary knob for opening the hot water / steam is not in the right position.
- **Flashing rapidly:** Ventilate the water system.

"Descaling" LED:

- **Flashing:** Start the descaling cycle.

Reset: Press the steam key for 10 seconds

 and  LEDs flashing alternately: turn off the appliance. Turn the appliance back on after 30 seconds and wait until the movements stop. Then turn the appliance off again. Remove the brewing unit and clean thoroughly (see page 29). If the display reappears when you turn the machine back on, contact the Service Centre.

3.1.2 Odea Giro, Talea Giro

"Appliance ready" LED:

- **Permanently on:** The appliance is ready for use.
- **Flashing:** The appliance has to finish the heating-up phase.

"Empty dreg drawer" LED:

- **Permanently on:** Empty the dreg drawer. The appliance must be switched on for this procedure.

Control to set how much coffee is dispensed into the cup.

Coffee dispensing key:

- **Flashing slowly:** 1 coffee selected (key pressed once).
- **Flashing rapidly:** 2 coffees selected (key pressed twice).

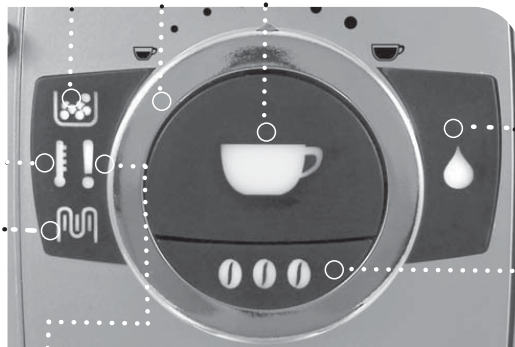

"Hot water" key:

- **Off:** The appliance dispenses steam.
- **On:** The appliance dispenses hot water.

Ground coffee quantity (Opti-dose) key.



Alarm LED:

- **Permanently on (one or more causes):** No coffee left, water tank is empty, the residual water tray is full (in this case the dreg drawer also has to be emptied to prevent problems).
- **Flashing slowly (one or more causes):** Brewing unit is missing, dreg drawer has not been inserted, coffee container cover has not been inserted, service door is open, rotary knob for opening the hot water / steam is not in the right position.
- **Flashing rapidly:** Ventilate the water system.

"Descaling" LED:

- **Flashing:** Start the descaling cycle.

Reset: Press the hot water key for 10 seconds

 and  LEDs flashing alternately: turn off the appliance. Turn the appliance back on after 30 seconds and wait until the movements stop. Then turn the appliance off again. Remove the brewing unit and clean thoroughly (see page 29). If the display reappears when you turn the machine back on, contact the Service Centre.

3.1.3 Talea Giro Plus

"Appliance ready" LED:

- **Permanently on:** The appliance is ready for use.
- **Flashing:** The appliance has finished the heating-up phase.

"Empty dreg drawer" LED:

- **Permanently on:** empty the dreg drawer. The appliance must be switched on for this procedure.

Control to set how much coffee is dispensed into the cup.

Coffee dispensing key:

- **Flashing slowly:** 1 coffee selected (key pressed once).
- **Flashing rapidly:** 2 coffees selected (key pressed twice).

"Hot water" key:

- **Off:** The appliance dispenses steam.
- **On:** The appliance dispenses hot water.

"Descaling cycle" key:

- **On:** Press for 3 seconds.
- **Off:** Press for 3 seconds.

Ground coffee quantity (Opti-dose) key.

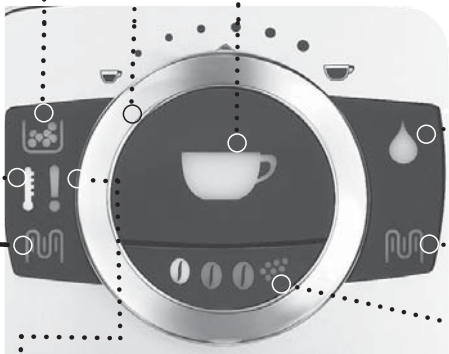



Alarm LED:

- **Permanently on (one or more causes):** No coffee left, water tank is empty, the residual water tray is full (in this case the dreg drawer also has to be emptied to prevent problems).
- **Flashing slowly (one or more causes):** Brewing unit is missing, dreg drawer has not been inserted, coffee container cover has not been inserted, service door is open, rotary knob for opening the hot water / steam is not in the right position.
- **Flashing rapidly:** Ventilate the water system.

"Descaling" LED:

- **Flashing:** Start the descaling cycle.

Reset: Press the hot water key for 10 seconds

Caution: If the  and  LEDs flashing alternately: turn off the appliance. Turn the appliance back on after 30 seconds and wait until the movements stop. Then turn the appliance off again. Remove the brewing unit and clean thoroughly (see page 29). If the display reappears when you turn the machine back on, contact the Service Centre.

3.1.4 Talea Ring, Ring Plus

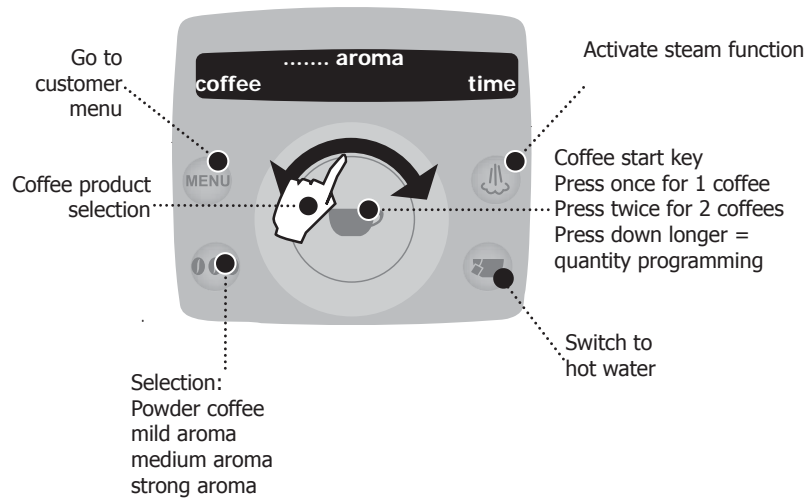

Customer programming menu

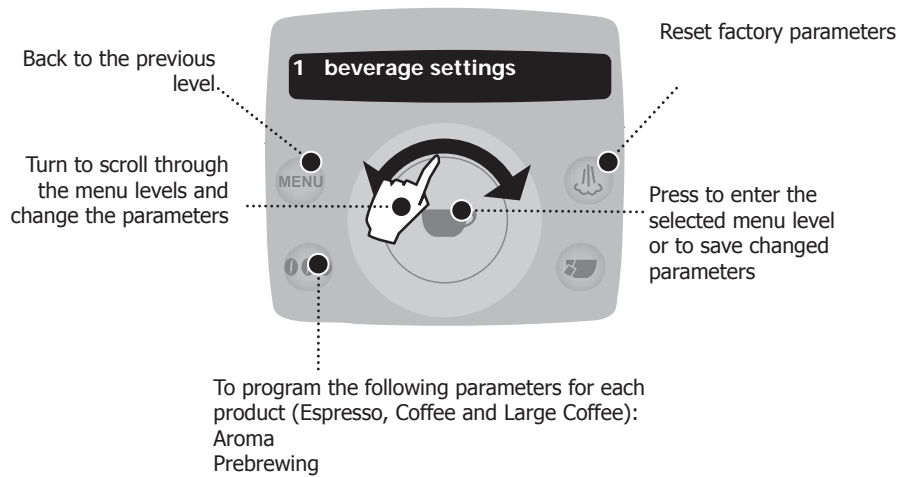

Main menu levels

1 beverage settings

Dosage quantity
Temperature
Prebrewing

2 machine settings

Language
Water hardness
Acoustic signal / alarm
Filter alarm
Rinsing
Cup warmer (Ring Plus)
Time setting (Ring Plus)

3 maintenance

Aqua Prima
Descaling
Clean brewing unit

4 energy saving

Switch-off time (standby)
Timer (switching time)





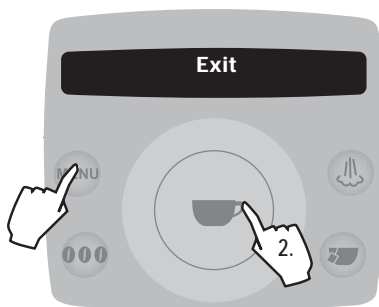









5 special functions

Restore settings (factory settings)



Cancel:
Press the menu key several times until you see "cancel" in the display, then confirm with the start key

Customer menu table

											
											1. Beverage settings
		1.1. Espresso 1.2. Coffee 1.3. Large coffee		Short press Long press		Cup capacity +/- Temperature low medium high		Prebrew normal long off		Aroma mild medium strong preground	
		2.1 Language 2.2 Water hardness 2.3 Signal alarms 2.4 Water filter alarm 2.5 Rinsing 2.6 Cup warmer ** 2.7 Clock setting **				8 languages 1,2,3,4 On/Off On/Off On/Off On/Off Time setting Time format				Hours - Minutes 24hr - am/pm	
in key											

3.1.5 TALEA Touch

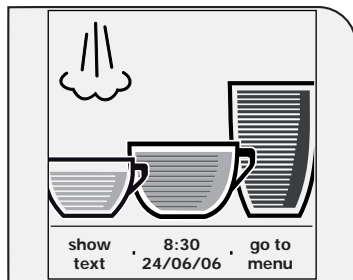

To start:
Press the "go to menu" key
Beverage programming:
Keep the relevant beverage key pressed

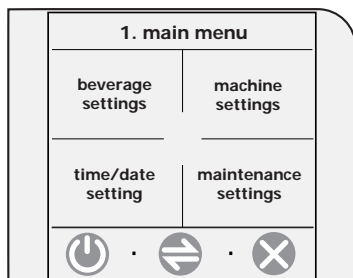
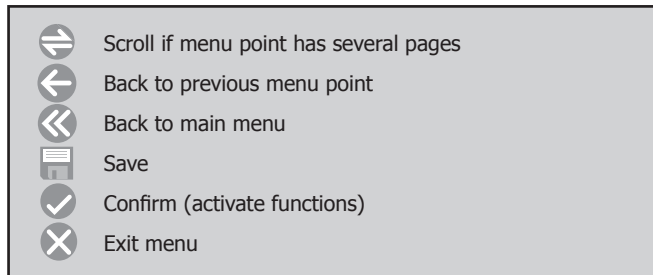

beverage settings:
Espresso, Coffee and Large Coffee settings
machine settings:
Language, acoustic signals, cup warmer and water settings
time/date settings:
Time, clock timer and standby settings
maintenance settings:
Product counter, cleaning cycle, descaling cycle and display lock

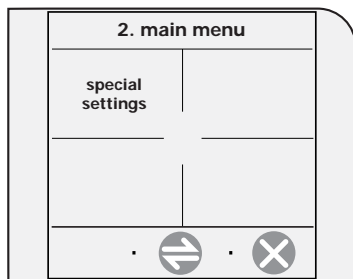

special settings:
Factory settings

Example, water hardness setting

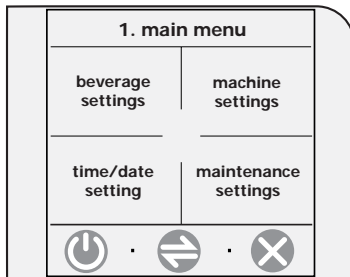

In the first main menu, select "machine settings"

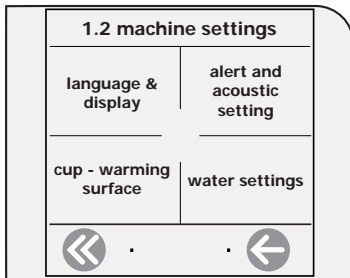

Press the "water settings" key

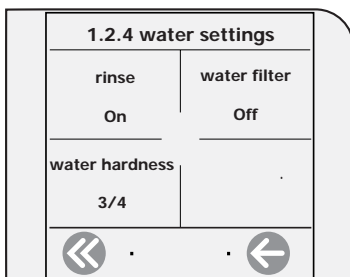

Press the "Water hardness" key

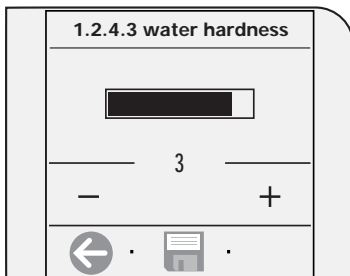

Carry out the settings with the +/- keys and save with the 📄 save key.

Customer menu table

Main menu		Customer menu table				
Beverage settings	1.1. Beverage setting	1.1.1. Espresso/1.2.Coffe/1.3.Large Coffee	Prebrewing	normal strong off low medium high mild normal strong preground + / -		
			Temperature			
			Aroma			
			Coffee capacity			
	Machine settings		1.2. Machine settings	1.1.1. Espresso/1.2.Coffe/1.3.Large Coffee	Language & display	11 languages + / -
					Acoustic signals and alarms	Machine ready Key tone always on always off off in standby
					Heated cup holder	
					Water settings	Rinse Aqua Prima Water hardness 1,2,3,4
					Current time	+ / -

1.	Time settings	1.3. Clock settings	1.3.1	Time format	Select	
			1.3.2	Current date	Year / Month / Day	
			1.3.3.	Date format	Select	
				after 15 minutes		
				after 30 minutes		
				after 1 hour		
			1.3.4.	after 3 hours		
				Interval 1	Hours / Minutes	
				Interval 2	Hours / Minutes	
				Interval 3	Hours / Minutes	
Machine on/off		Day settings	Select			
2.	Special settings	2.1. Special settings	1.4. Maintenance settings	1.4.1.	Product counter	Espresso
					Coffee	
					Large coffee	
					Reset	
				1.4.2	Cleaning cycle	Yes/no
				1.4.3	Descaling cycle	Yes/no
				1.4.4	Display lock	Release
				2.1.1.	Factory settings	no/yes

3.2 Use, cleaning and maintenance

Using the machine		
1	Insert the limescale filter	If available
2	Fill water tank	
3	Fill bean hopper	
4	Turn on the appliance	
5	Carry out machine settings (machines with display only)	Determine and set water hardness, activate limescale filter IMPORTANT: if the limescale filter is not inserted for longer periods, the relevant setting must be set to "OFF" otherwise the descaling interval calculated by the appliance is too long and this results in limescale building up in the appliance. Two settings must be programmed on models with ring function: 1. Machine settings: 2.4 Alarm Filter ON/OFF 2. Maintenance / Aqua Prima: 3.1.2 Additional Filter ON/OFF
6	Specify the product (machines with display only)	Cup capacity, dosing quantity, prebrewing
7	Press the start key	Press 1x for 1 coffee, press 2x for 2 coffees

Cleaning and service		
A	Empty dreg drawer	When message appears
B	Empty drip tray	When message appears
C	Clean water tank	Weekly
D	Clean coffee bean hopper	As necessary
E	Clean housing	As necessary
F	Clean brewing unit	2 - 3 x weekly or after 50 coffees
H	Carry out a descaling cycle	When message appears
J	Clean drip tray	Weekly
K	Clean brewing unit compartment	Weekly

Descaling cycles			
Hardness	Water hardness	Interval without limescale filter	Interval with limescale filter
1	Soft water (up to 7°dH)	approx. every 3 months / 120 litres	approx. every 6 months / 240 litres
2	Medium hard water (7°-14°dH)	approx. every 2 months / 90 litres	approx. every 4 months / 180 litres
3	Hard water (15°-21°dH)	approx. every 6 weeks / 60 litres	approx. every 3 months / 120 litres
4	Very hard water (over 21°dH)	approx. every 4 weeks / 30 litres	approx. every 6 weeks / 60 litres

3.3 Messages - troubleshooting

DISPLAY MESSAGE SHOWN	INSTRUCTIONS FOR TROUBLESHOOTING
Turn machine off and on to solve the problem	Turn the appliance off and then back on after 30 seconds to resolve the fault.
Call Service Centre	The problem requires the intervention of the Service Centre
Insert drip tray	Insert the drip tray
Close coffee bean hopper lid	The coffee bean hopper lid must be closed to produce beverages.
Insert ground coffee	This message is shown if the user selected the use of this type of coffee when the products were specifically programmed.
Insert brewing unit	Insert the brewing unit in its intended location
Insert dreg drawer	Insert the dreg drawer
Empty dreg drawer	Remove the dreg drawer and empty. NOTE: the dreg drawer must only be emptied when the appliance is switched on. The drawer must be removed for at least 5 seconds. If the drawer is emptied when the appliance is switched off the message is not reset.
Close side door	Close the service door.
Fill water tank	Fill the water tank
Empty residual water tray	Empty residual water tray
Prime circuit	Start the automatic water cycle filling The appliance makes 5 attempts to fill the cycle automatically. If these attempts fail, the Service Centre must be informed about these ventilation attempts.
The descaling cycle did not run correctly.	Repeat the operation as described in the appropriate chapter in the instruction booklet
Replace Aqua Prima filter	This message is only displayed if the filter control is enabled (see notes in the instruction booklet) The filter should be replaced in the following cases: 1) Over 60 litres of water have been dispensed for drinks 2) 90 days have elapsed since installation 3) 20 days have elapsed since the coffee maker was last used.
The cleaning cycle did not run correctly	Repeat the operation as described in the relevant chapter in the instruction booklet.
Descale appliance	Carry out the descaling cycle
Standby	Press the "ON" key

CHAPTER 4 FUNCTIONAL PRINCIPLES

4.1.1 Odea Go water system

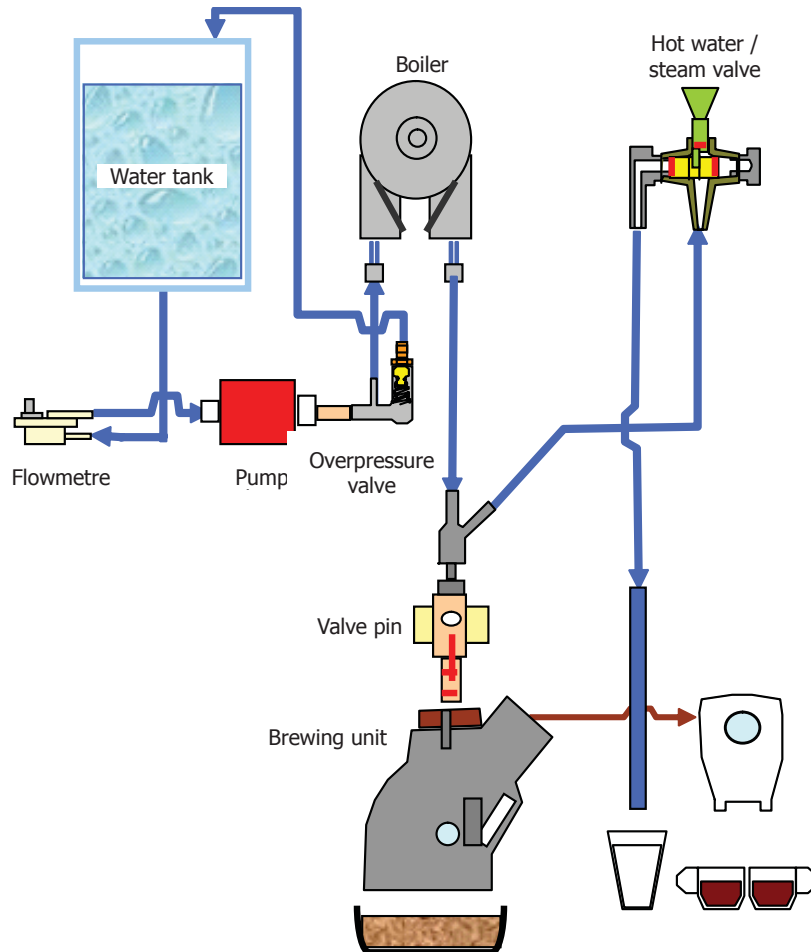
**Odea Go**

- Conventional water system
- Flowmetre - cup capacity / ventilation display
- Reciprocating piston type pump (13 - 15 bar)
- Overpressure valve (opening pressure 18 - 20 bar).
- Boiler (= continuous-flow heater) 1300 W
- Valve pin (mechanical valve opener)
- Hot water / steam valve (switch between coffee / hot water, steam output)

4.1.2 Talea, Odea Giro water system

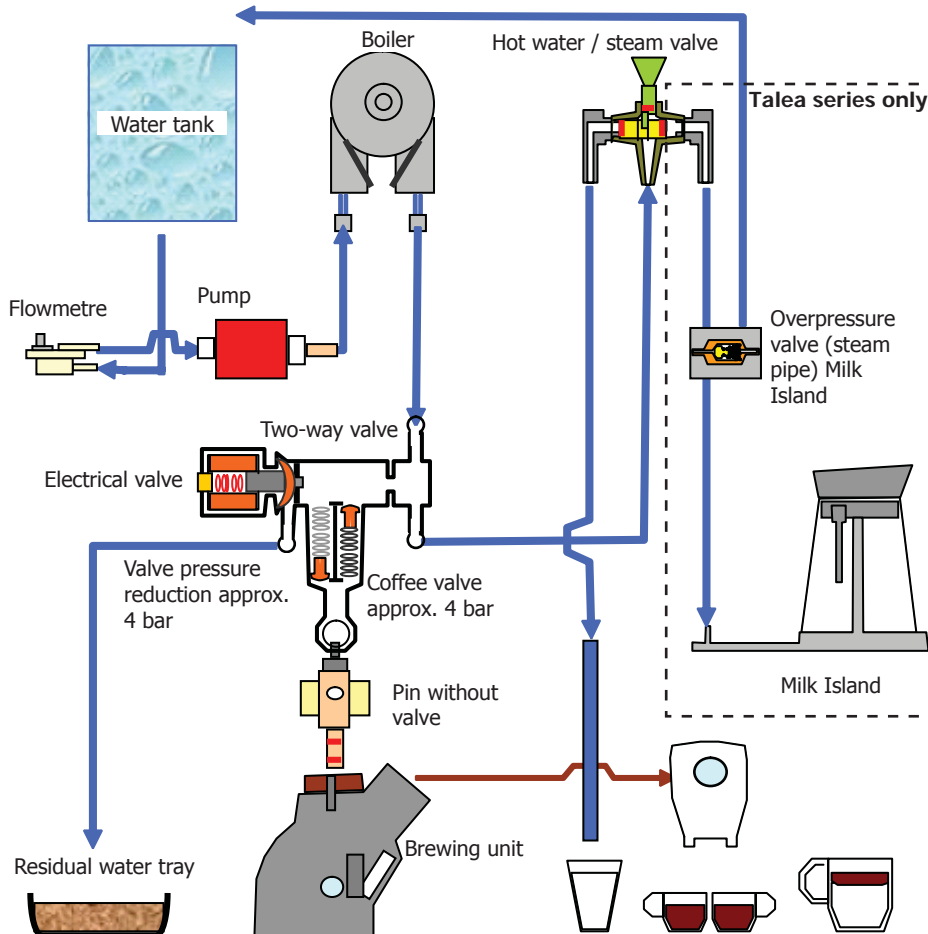
**Talea, Odea Giro**

- The solenoid valve has several functions and these are described in the following paragraphs. A mechanical overpressure valve is integrated in the electrical valve which opens at approx. 18 - 20 bar.
- When dispensing coffee and the hot water / steam valve is closed, the coffee valve opens at approx. 4 bar and the water is pressed through the brewing unit.
- The overpressure valve in the steam pipe to the Milk Island protects the system against damage caused by pressure, the steam state overpressure is fed back to the fresh water tank.
- The multi-way valve opens selectively depending on the operating situation in the flow direction (dispensing) or against the flow direction (pressure release).

4.2. Solenoid valve / multi-way valve

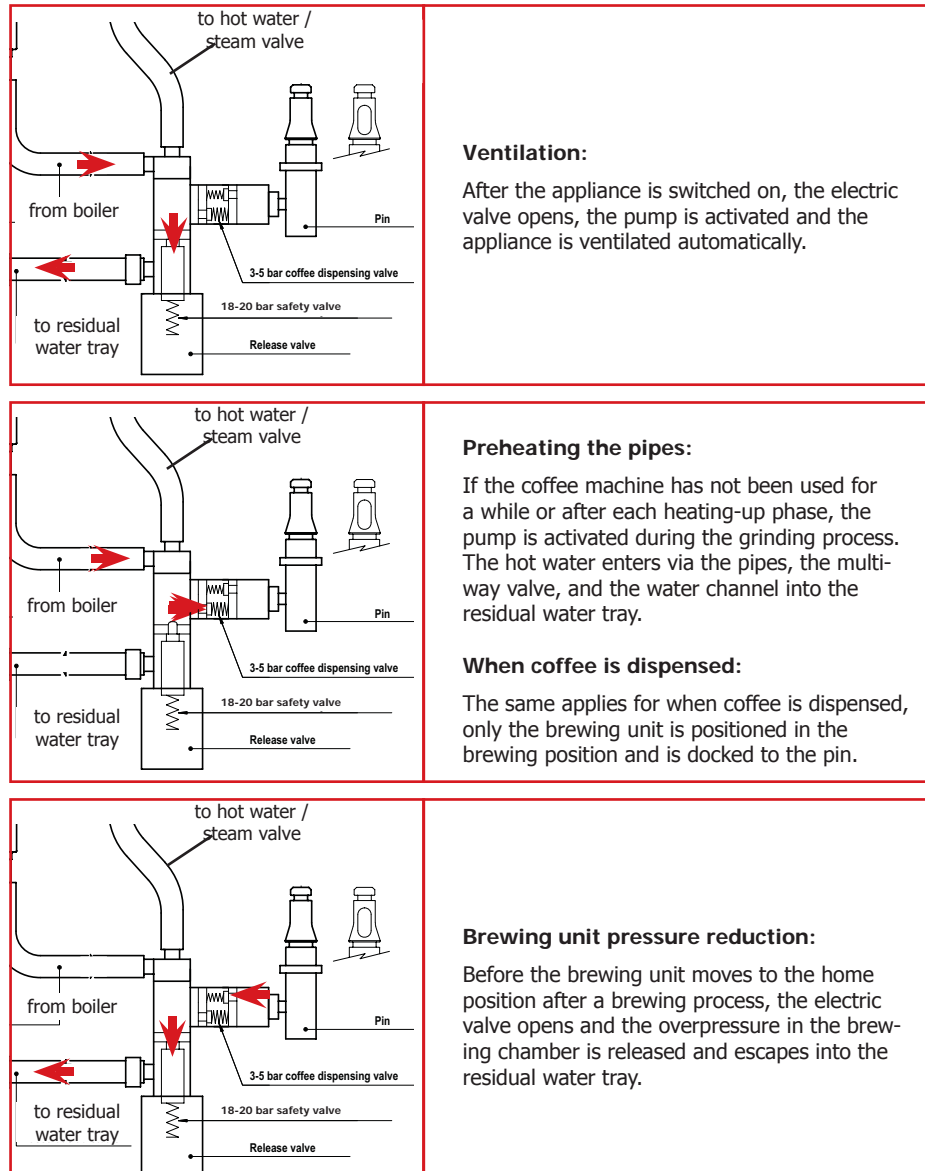

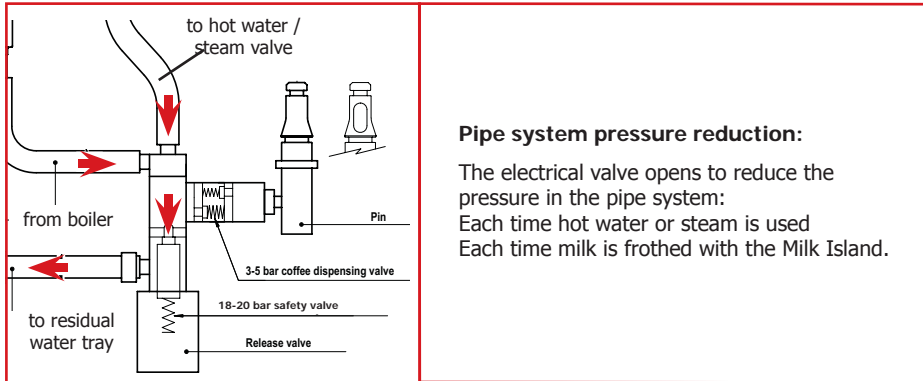

Pipe system pressure reduction:
 The electrical valve opens to reduce the pressure in the pipe system:
 Each time hot water or steam is used
 Each time milk is frothed with the Milk Island.

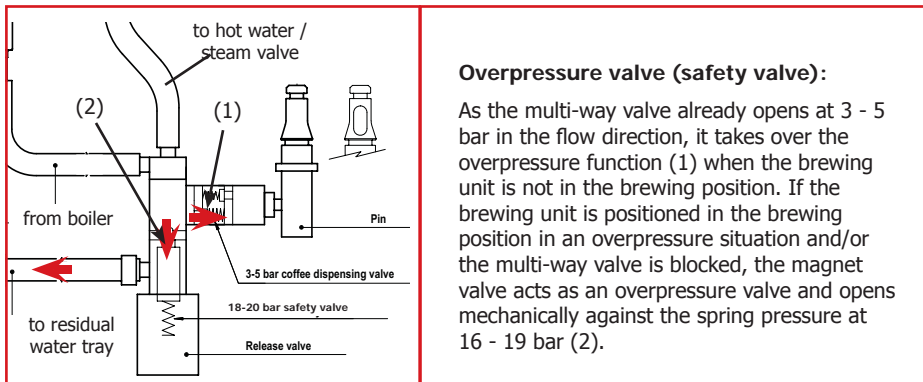

Overpressure valve (safety valve):
 As the multi-way valve already opens at 3 - 5 bar in the flow direction, it takes over the overpressure function (1) when the brewing unit is not in the brewing position. If the brewing unit is positioned in the brewing position in an overpressure situation and/or the multi-way valve is blocked, the magnet valve acts as an overpressure valve and opens mechanically against the spring pressure at 16 - 19 bar (2).

4.3. Hot water / steam faucet

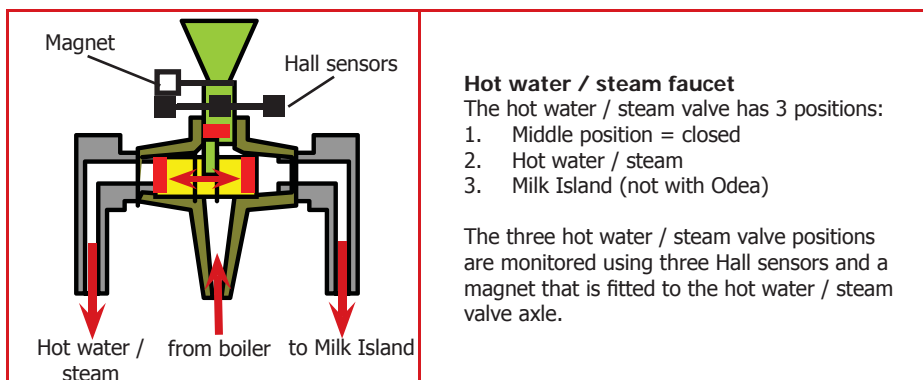

Hot water / steam faucet
 The hot water / steam valve has 3 positions:
 1. Middle position = closed
 2. Hot water / steam
 3. Milk Island (not with Odea)

The three hot water / steam valve positions are monitored using three Hall sensors and a magnet that is fitted to the hot water / steam valve axle.

4.4. Coffee cycle

Main switch ON	START		STOP
Timing			
Coffee grinder		Pulse (Dosage)	
Heating	approx. 45 secs	[Heating bars]	
Pump		*	Pump activity (flowmetre pulses) according to cup capacity
Gearing motor / brewing unit	[Down arrow]	[Up arrow]	[Down arrow]
Status	Warm-up phase	Ready	Coffee cycle

Note: * With prebrewing only

Status MS1	[Red bar]	[Red bar]	[Red bar]
Status MS2	OFF	[Red bar]	ON

Gearing mechanism with 2 microswitches (MS)

Status MS	OFF	[Red bar]	ON
-----------	-----	-----------	----

Gearing mechanism with single microswitch (MS)

To turn on:

- When the main switch is activated, the gearing mechanism searches for its original position and moves downwards into the Microswitch (MS) (with cam 1, see the following section). The gear motor changes the direction of rotation, moves back up and stops approx. 1 - 2 mm after leaving the microswitch.
- The continuous-flow heater then starts to heat the water for approx. 45 seconds to reach the operating temperature,
- 40 seconds of which is spent at full heating power and the rest is spent recycling the power.

Coffee cycle:

1. The coffee grinder starts the grinding process (pulse-controlled).
2. The gearing mechanism (brewing unit) moves to the brewing position.
3. Then the prebrewing begins (brief pumping activity, then a quick break).
4. Brewing procedure (length of the pumping activity, depending on the coffee quantity selected).
5. The gearing mechanism moves to its original position (brew grounds are automatically ejected).

4.5. Brewing unit's gear mechanism

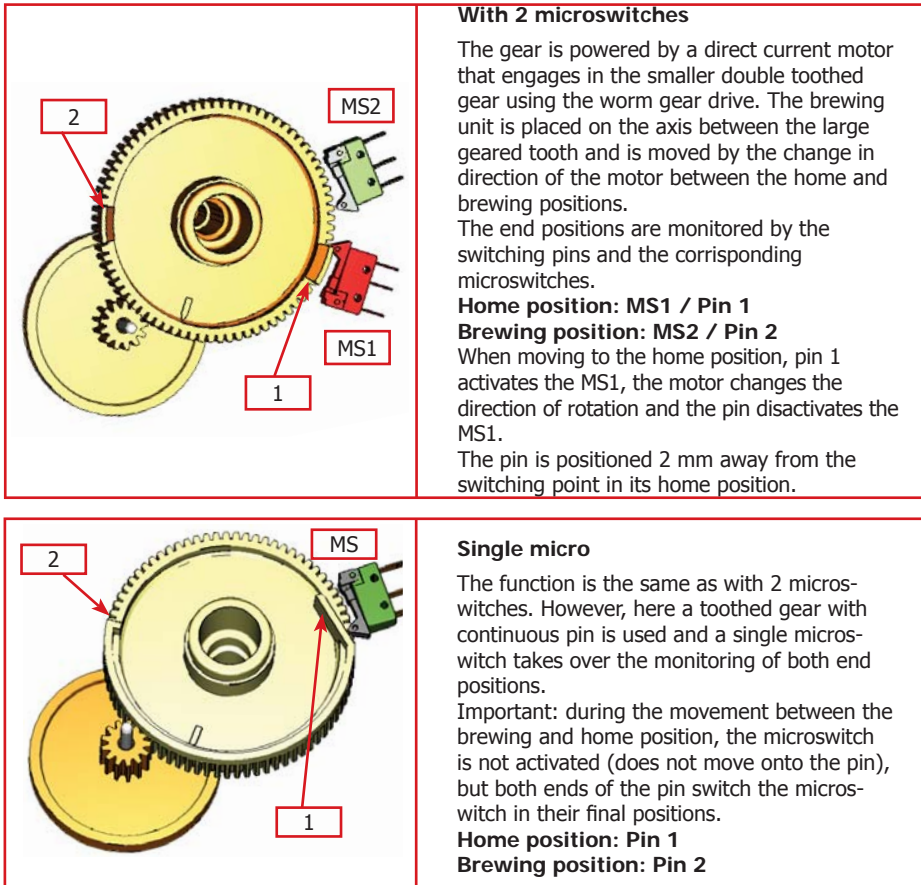
**With 2 microswitches**

The gear is powered by a direct current motor that engages in the smaller double toothed gear using the worm gear drive. The brewing unit is placed on the axis between the large geared tooth and is moved by the change in direction of the motor between the home and brewing positions.

The end positions are monitored by the switching pins and the corresponding microswitches.

Home position: MS1 / Pin 1

Brewing position: MS2 / Pin 2

When moving to the home position, pin 1 activates the MS1, the motor changes the direction of rotation and the pin disactivates the MS1.

The pin is positioned 2 mm away from the switching point in its home position.

Single micro

The function is the same as with 2 microswitches. However, here a toothed gear with continuous pin is used and a single microswitch takes over the monitoring of both end positions.

Important: during the movement between the brewing and home position, the microswitch is not activated (does not move onto the pin), but both ends of the pin switch the microswitch in their final positions.

Home position: Pin 1

Brewing position: Pin 2

4.6. Temperature sensor (control)

T (°C)	R (kΩ)	ΔR (+/- %)
20	61.465	8.6
50	17.599	5.9
75	7.214	4.1
80	6.121	3.7
85	5.213	3.4
90	4.459	3.1
100	3.3	2.5
125	1.653	3.9
150	0.893	5.1

Temperature sensor

An NTC is used as the temperature sensor: If the NTC senses too high temperatures, electronics decreases boiler's temperature that is controlled by the resistance's voltage.

Resistance values and the corresponding temperatures: see table

4.7. SBS

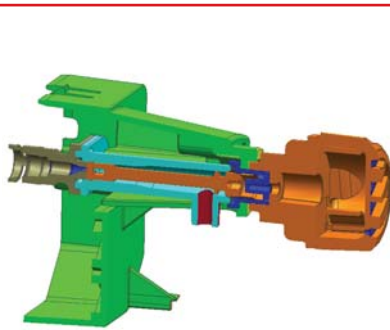
**SBS - Saeco Brewing System - principle**

Controlling the flow speed that then influences the contact time between the coffee and water, changes the extraction and therefore the taste intensity and strength of the coffee.

- Slower flow: strong extraction
- Rapid flow: weaker extraction

SBS / dispensing valve

Turning the SBS control knob creates a back pressure in the brewing unit where the flow speed is regulated using a controllable cream valve.

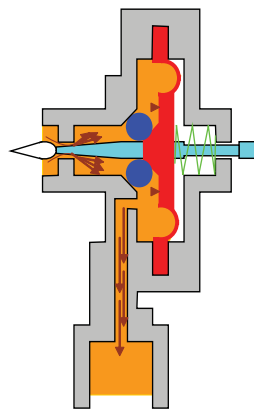
**Cream valve control
High flow (slow extraction)**

The coffee can flow much easier when the SBS valve is open. The pressure applied to the membrane remains comparatively low and with the support of spring, the membrane almost stays in its original position and the control needle is not pulled into the opening - the flow remains unchanged.

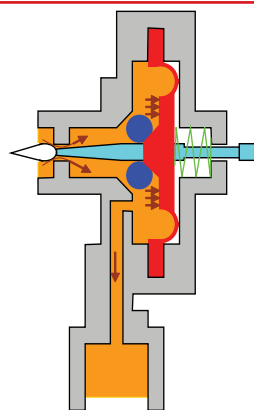
**Cream valve control
Low flow (strong extraction)**

The coffee can only dispense inadequately with a throttled SBS valve - a back pressure forms, forcing the membrane to the side and pushing it against the spring force. In the next stage, the valve needle is pulled into the opening that, in turn, reduces the flow.

4.8. Coffee grinder

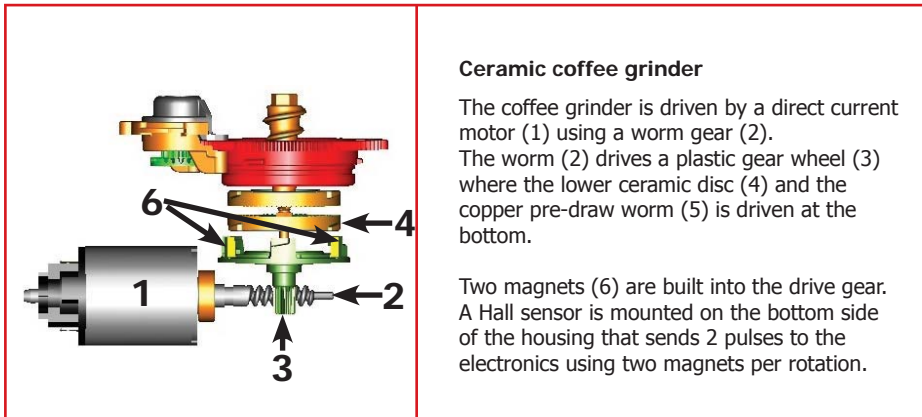
**Ceramic coffee grinder**

The coffee grinder is driven by a direct current motor (1) using a worm gear (2).

The worm (2) drives a plastic gear wheel (3) where the lower ceramic disc (4) and the copper pre-draw worm (5) is driven at the bottom.

Two magnets (6) are built into the drive gear. A Hall sensor is mounted on the bottom side of the housing that sends 2 pulses to the electronics using two magnets per rotation.

4.9. Dosing quantity control, coffee grinder blockage when machine is low on beans

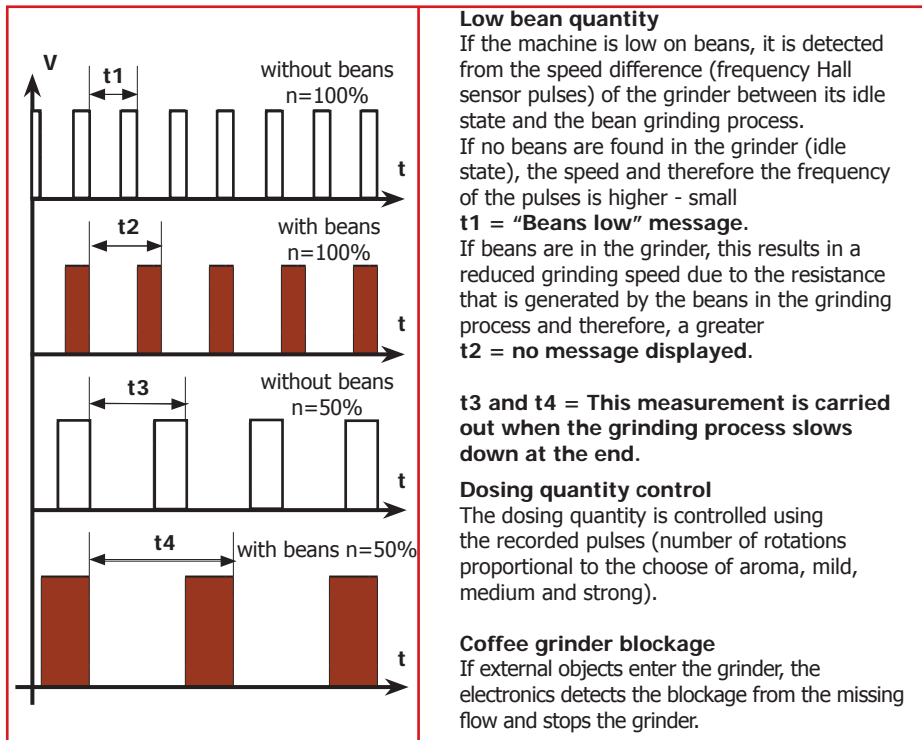
**Low bean quantity**

If the machine is low on beans, it is detected from the speed difference (frequency Hall sensor pulses) of the grinder between its idle state and the bean grinding process.

If no beans are found in the grinder (idle state), the speed and therefore the frequency of the pulses is higher - small

t1 = "Beans low" message.

If beans are in the grinder, this results in a reduced grinding speed due to the resistance that is generated by the beans in the grinding process and therefore, a greater

t2 = no message displayed.

t3 and t4 = This measurement is carried out when the grinding process slows down at the end.

Dosing quantity control

The dosing quantity is controlled using the recorded pulses (number of rotations proportional to the choose of aroma, mild, medium and strong).

Coffee grinder blockage

If external objects enter the grinder, the electronics detects the blockage from the missing flow and stops the grinder.

4.10. Autodose - automatic dosing quantity control

Autodose

The appliances are fitted with an automatic dosage quantity adjustment from the following software versions:

Type	Software version with autodose
Talea Touch	≥ V.01.08.14
Talea Ring Plus / Ring	≥ V.02.00.08
Talea Giro e Odea Giro / Go	≥ V01.02.01

Function:

The coffee machine adjusts automatically the average coffee dose with an algorithm based on three informations that it detects via the electronic board:

1. Number of grinding pulses performed during the grinding,
2. Maximum of average values of the current consumption of the gear device during the coffee pressing,
3. Aroma selected by the customer.

The algorithm compares the maximum of the average values of the gear device's current consumption with the range defined to the selected aroma fuction in order to adjust the number of grinding pulses for the next coffee.

If the value of the current consumption is less than the minimum of the range defined for the aroma in question, the grinding pulses will be increased by 2.

If the value of the current consumption is more than the maximum of the range defined for the aroma in question, the grinding pulses will be decreased by 4.

If the value of the current consumption is within the range defined for the "Exceeded stress", the coffee will be brewed and the grinding pulses will be decreased by 10.

If the value of the current consumption is within the range defined for the "Ejection", the coffee cake will be ejected and the grinding pulses will be decreased by 10.

In the customer has selected "coffee powder" as the aroma, no adjustment will be done.

	Setting/status	Current consumption	Pulses corrected in the next grinding process	
			Exceeded by	Deficient by
		Area		
A	mild aroma	200 - 300 mA	-4	+2
B	medium aroma	301 - 450 mA	-4	+2
C	strong aroma	451 - 600 mA	-4	+2
D	Stress	601 - 800 mA	-4	
E	Exceeded stress	801 - 1,000 mA	-10	
F	Ejection of dry coffee	> 1,000 mA	-10	

This guarantees that, regardless of the coffee type used, the grinding level setting or possible wear to the grinding disc always remains constant when dosing.

Important:

The machine monitors in the area of the fields shown in green (A,B,C) during normal operation. This area is normally only left when changing the type of coffee (new bean type / fat content, new blend). Therefore when changing the type of coffee, a few dispenses may be subject to under or over dosage (until the controller has compensated for the change).

Caution: In case of overdosage, dry coffee may be ejected several times as a result. This is not a fault and can occur during first use or after a service.

4.11. Water level detection of fresh water tank

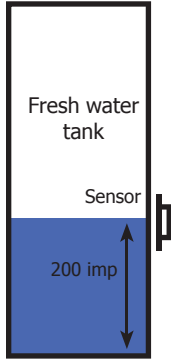
 <p>Fresh water tank</p> <p>Sensor</p> <p>200 imp</p>	<p>“Low water” message (water reserve)</p> <p>Function: The water level is monitored using a capacitive sensor. This is fitted on the side of the machine at the height level of the lower third of the water tank. When the sensor communicates to the electronics that there is no water in the tank at its level, there is still a water reserve of 200 flowmetre pulses remaining for the current dispensing that will be completed. If a drink cycle ends after the sensor has been triggered (in the reserve) then the message "Water low" continues to be displayed also the next time you request a drink.</p>
--	--

4.12. Limescale filter

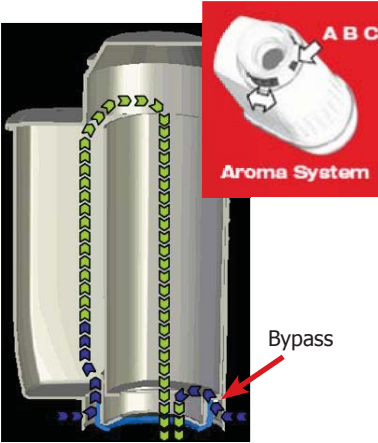
 <p>Aroma System</p> <p>A B C</p> <p>Bypass</p>	<p>Limescale filter Intenza (Brita)</p> <p>Function:</p> <ul style="list-style-type: none"> • Reduction or delay of limescale deposits. • Improved quality of water. • Optimum taste due to the ideal water hardness. <p>Life span / descaling performance:</p> <ul style="list-style-type: none"> • - 10° dH • 60 litres • 2 months <p>To achieve the best possible consistency in the operating mode over the total life span, the water is blended using a 3 stage bypass (A, B, C) depending on the degree of hardness. See the small picture.</p>
--	---

4.13. Water level detection of residual water tray

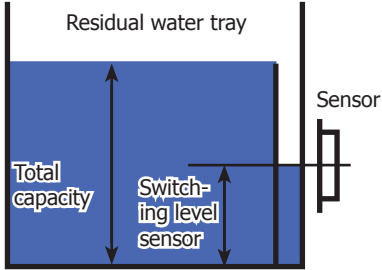

“Empty residual water tray” message

Function:
The residual water level is monitored using a capacitive sensor. The sensor is positioned approx. half way up the upper edge of the residual water tray. To ensure the best possible use of holding capacity, the sensor is positioned in the area of a shaft where its upper edge overlaps the sensor. Therefore, the residual water tray fills up to the upper edge of the shaft and the overflow in the shaft triggers the sensor and therefore displays to empty residual water tray.

Exception:
Odea: from 2008 production, the Odea series is no longer fitted with a residual water sensor. The capacity is calculated by the electronics, depending on the dispensing situation (coffee, steam, hot water, rinsing).

4.14. “Empty dreg drawer” message

“Empty dreg drawer” message:

The following destinations are stored in the diagnosis menu for the message, **“Empty dreg drawer”**:

- Grounds limit (maximum dregs)
- Actual grounds (dreg counter)
- Grounds warning

Grounds limit is programmed to 13 cycles as standard. The counter **“actual grounds”** takes over this value when you empty the dreg drawer and deducts one of these values with each cycle.

If the value is 0, **“Empty dreg drawer”** appears (a request of dispensing is no longer possible). If the last order was a double cup function, the programming allows another 14th use and then displays **“Empty dreg drawer”**.

If the counter **“actual grounds”** reaches a value of **“grounds warning”** during the process (e.g. “3”), the advanced notice **“Empty dreg drawer”** appears on appliances with a display (coffee can still be dispensed).

When the dreg drawer is emptied, the counter **“actual grounds”** will be reset (after 5 seconds).

4.15. Descaling request

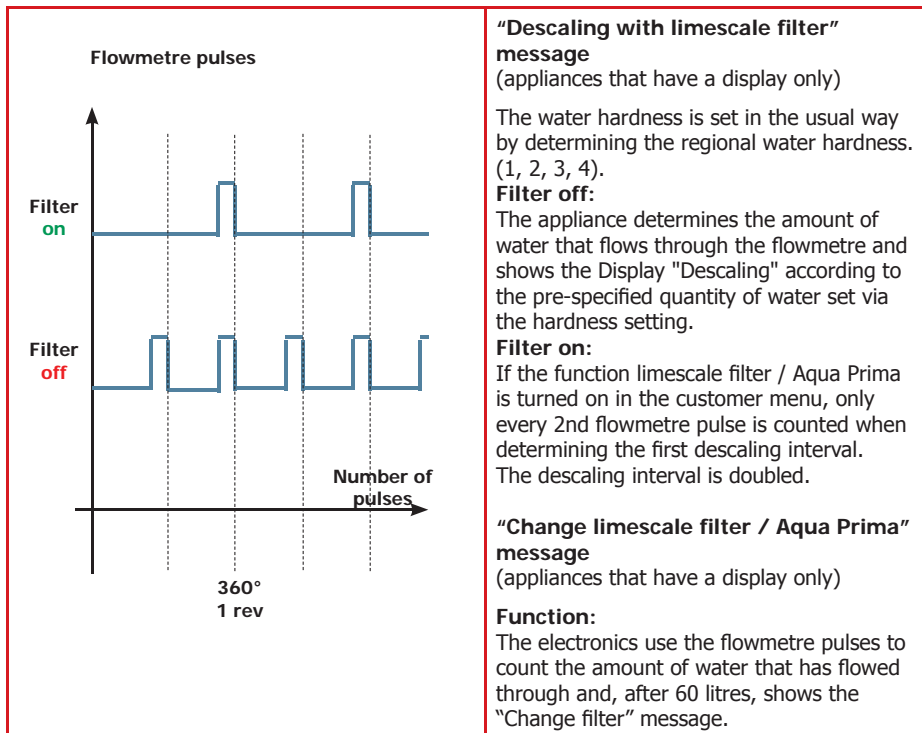

4.16. Electronical configuration (DIP - switch settings)

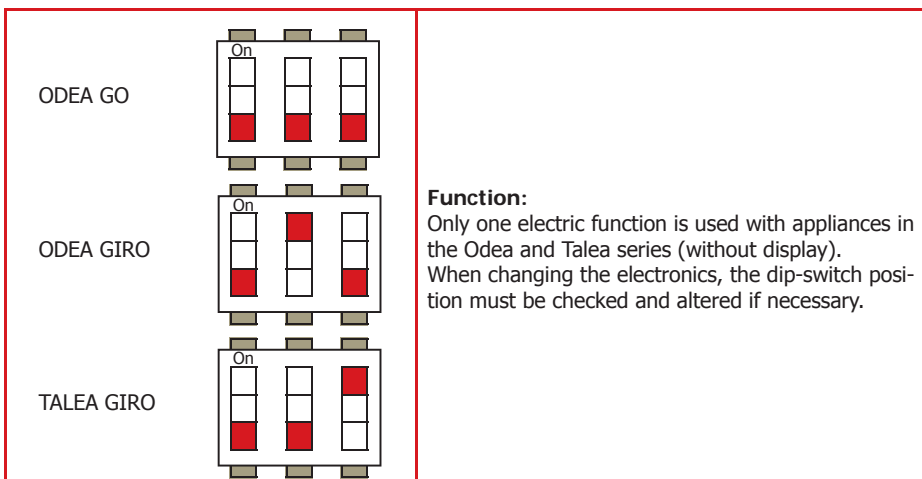

4.17. Cup lift

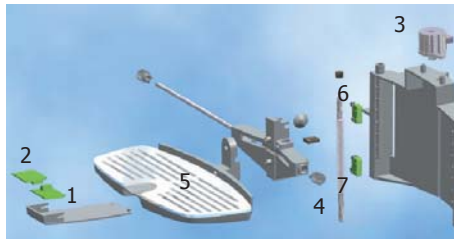
**Electrical cup lift**

(Talea Touch and Ring Plus only)

Operation:

The cup lift is activated via two capacitive sensors located on the front part of the cup holder.

The lower sensor (1) activates the upwards function.

The upper sensor (2) the downwards function.

Function:

The sensors control an inching motor (3) in different rotating directions.

A spindle (4) where the bottom end is attached flush with the cup plate (5), gets turned by the direction of motion of the motor: lifting or lowering.

The end positions are monitored by two microswitches: upper end switch (6) and lower end switch (7).

4.18. Milk Island

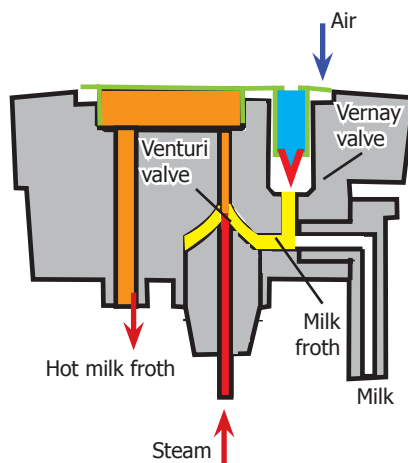
**Milk Island**

(Talea series only / optional)

Function:

The function of the Milk Island is based on the Venturi principle in combination with a Vernay valve.

1. The steam flowing into the Venturi valve produces a high subpressure that absorbs the milk.
2. In turn, the milk generates a subpressure when flowing past the Vernay valve that sucks air in via the Vernay valve.
3. The milk is frothed using this air.
4. The milk froth and the steam make contact in the Venturi nozzle and the milk froth is heated up.

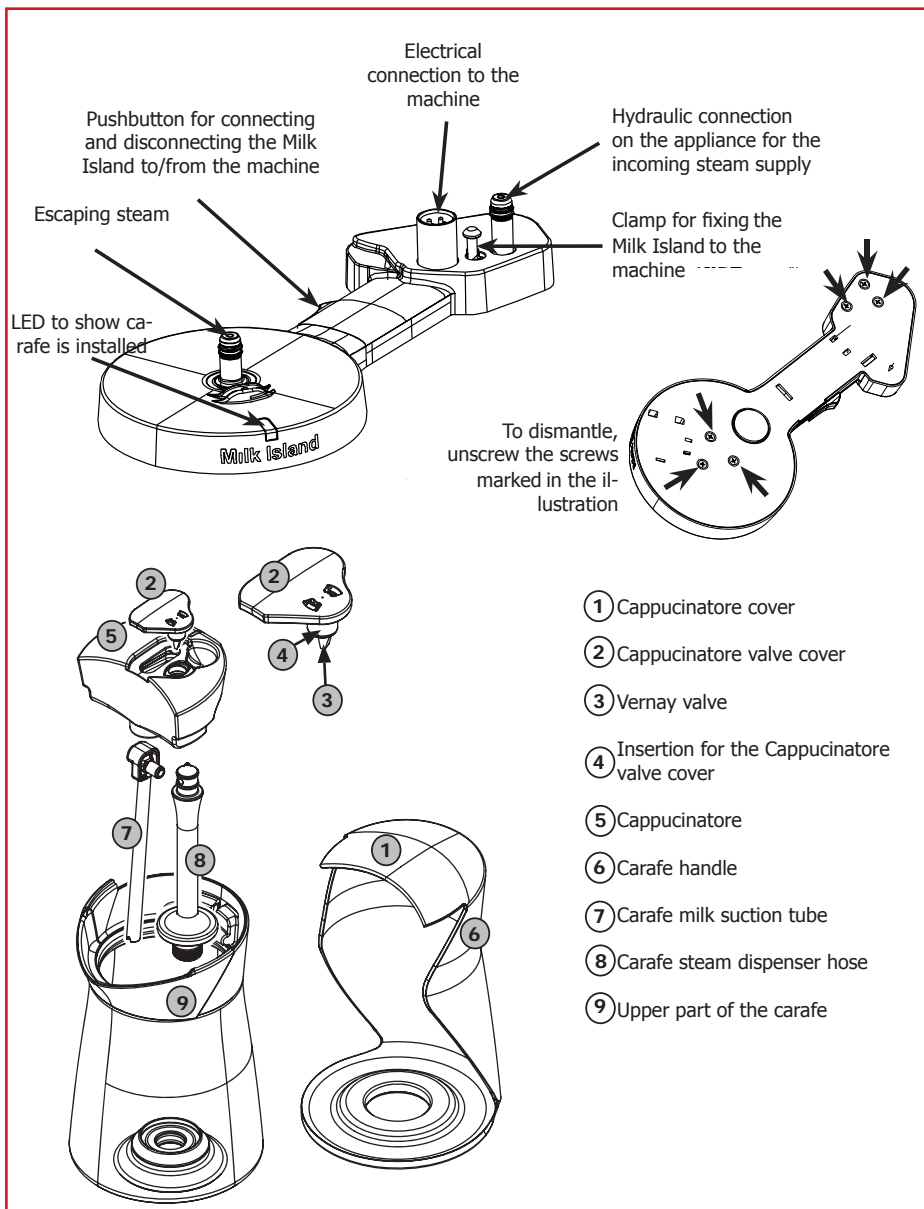













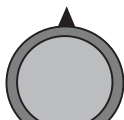

Caution: if the base station of the Milk Island is removed from the coffee machine, it is absolutely necessary to apply the lock on the bottom of the machine!

CHAPTER 5









SERVICE MODALITY

5.1.1. Test mode - Talea Giro and Odea

- Press the hot water key (steam key on the Odea Go) and turn the appliance on at the same time. Keep the hot water key or the steam key pressed until all four LEDs flash in the following sequence  (anticlockwise)









Rotary knob to set cup capacity		 Odea Go only	 not with Odea Go	Function	Display
	X			Electrical valve	
		X	X	Coffee grinder	
		X + hot water / steam valve open		Letting steam out with new software	
	X			Heating	
		X		Brewing unit ↓ (home position gear microswitches activated)	
	X			Pump flowmetre pulses	
		X		Brewing unit ↑ (brewing position gear microswitch)	
				Dosing quantity setting for coffee quantity test in test mode.  =90 pulses  =100 pulses  =110 pulses	

Messages / Errors





Function	Signal	Display
Hot water / steam valve (open)	lit	
Microswitch of brewing unit not activated (missing)	flashing	
Dreg drawer's reed switch (missing)	flashing	
Reed switch for doors (open)	flashing	
Bean hopper cover's reed switch (missing)	flashing	
Flowmetre pulses (when the pump is active)	flashing	
Microswitch of milk carafe presence (hot water / steam valve closed)	lit	
Water tank's sensor (no water)	lit	
Residual water tray's sensor (full)	lit	

5.1.2. Special function mode - Talea Giro and Odea

- Press the start key and turn the appliance on at the same time. Keep the start key pressed until all four LEDs flash in the following sequence  (clockwise)
The following functions are no longer available with those appliances that are installed with the automatic dosing regulation.

Rotary knob to set cup capacity	Key	Function	Display	Comment
		Let steam out (approx. 2 min / hot water / steam valve open)		Flashing in clockwise sequence
	 Odea Go only	Press the key to reduce the dosing quantity pulses by 5 pulses each (setting range 60 - 150) standard 80 -100	 Odea Go only	The LED lights up when the key is pressed. If the value is at the minimum, the LED no longer lights up or flashes when pressed (depending on the model)
	 Odea Go only	Press the key to increase the dosing quantity pulses by 5 pulses each time. (setting range 60 - 150) standard 80 -100	 Odea Go only	The LED lights up when the key is pressed. If the value is at the maximum, the LED no longer lights up or flashes when pressed (depending on the model)

Messages / Errors

Function	Status	Signal	Display
Brewing unit present - microswitch	Switch not on	lit	
Dreg drawer sensor	Sensor not on	lit	
Hot water / steam valve sensor	Sensor not on	lit	
Bean hopper cover sensor	Sensor not on	lit	

5.2.1 Test mode - Talea Ring and Ring Plus



Getting started with test mode:

- Turn on the appliance.
- Keep the menu key pressed for approx. 2 seconds until "Cancel" appears in the display.
- Then press the aroma, steam, menu and hot water keys in that order (1,2,3,4).

Navigation:

- Use the ring function to move through the menu levels.
- Activate each function with the relevant key.
- Adjust with the ring.
- Save with the coffee/start key.

Function level/display	Key	Function	Display/description
Test M0			
Key check / time / software version / mains frequency			
* Test* M0 (12345) time Ver.00.00.00 50/60Hz	Steam Hot water Aroma Menu Coffee/Start	Keypad check	1: Steam key OK 2: Hot water key OK 3: Aroma key OK 4: Menu key OK 5: Coffee/Start key OK
Test M1			
Sensor/microswitch test (can only be carried out manually)			
Test M1 time Inputs(123456789ABCDEFGH)		Sensor/ microswitch test	1: Brewing unit microswitch 2: Brewing position gearing mechanism micro 3: Home position of gearing mechanism micro 4: Flowmetre (Hall sensor) 5: Water tank sensor (capacitive) 6: Door switch (reed sensor) 7: Dreg tray (reed sensor) 8: Bean cover (reed sensor) 9: Coffee grinder (Hall sensor) A: Drip tray sensor (capacitive) B: Hot water / steam valve Sensor pos. Milk Island C: Hot water / steam valve Sensor pos. Water/steam D: Milk Island (adapter) detected E: Carafe microswitch F: Cup lift, bottom end switch G: Cup lift, top end switch H: Hot water / steam valve Sensor pos. closed
Test M2			
Test: Brewing unit test (power input / microswitch)			
Test M2 (6712) mA going to work xxx	Menu	Brewing unit up	Brewing position microswitch 2 xxx Power consumption of gear motor
Test M2 (6713) mA going to home xxx	Aroma	Brewing unit down	Home position microswitch 3 xxx Power consumption of gear motor

Function level/display	Key	Function	Display/description
Test M3	Test: El.valve/Adjust,Test Dosage quantity/Pump Flowmeter		
Test M3 xx yy z (8)	Menu	Elctronic valve	z: Ev Brew (the electro valve opens) 8: Sensor bean cover (closed)
Test M3 Setup Aroma (imp) tt	Enter: Coffee Adjust: Ring Store: Coffee	Dosage quantity - start position	tt: 60 - 150 dosage quantity start position (From Version 02.00.08 autodose)
Test M3 xx yy u (8)	Aroma	Dosage quantity for the grinder test	u: 1 = mild start position -10% u: 2 = medium start position u: 3 = strong start position +10%
Test M3 (F) xx yy Grinder (8) vv ww	Steam	Grinder on	Grinds the dosage quantity resulting from the start position and u (1,2,3) vv: Number of pulses ww: Pulses/sec. F: Failed (low on beans) S: Successful (beans detected) xx: Factory parameters yy: Factory parameters
Test M3 xx yy Flowmetre (pulses/s) ff	Hot water	Pump on	ff: Number of pulses/sec (approx. 14-17)
Test M4	Test: Continuous-flow heater / cup warmer / temperature display		
Test M4 4 Cup Heater	Menu	Cup warmer	Cup warmer heats up - No temperature display 4: Key test (menu key)
Test M4 3 Heater	Aroma	Continuous-flow heater	Continuous-flow heater heats up Temperature quantity with hot water key 3: Key test (Aroma key)
Test M4 2 Boiler temperature tt	Hot water	Temp. display	tt: Boiler temperature 2: Key test (hot water key)
Test M4 2 Boiler Temperature tt	Hot water / steam valve - Valve open + coffee key	Let steam out	tt: Boiler temperature Heats up to 110°C after completing the display pass!!
Test M5	Test: Cup lift (Ring Plus only)		
Test M5 4 (67) Cuplift Position	Menu	Upwards movement	G: Upper end switch activated 4: Key test (menu key) 6: Cup lift UP sensor 7: Cup lift DOWN sensor
Test M5 3 (67) Cuplift Position	Aroma	Downwards movement	F: Bottom end switch activated 3: Key test (Aroma key) 6: Cup lift UP sensor 7: Cup lift DOWN sensor
Test M6	Adjustment: LCD Contrast		
Test M6 time LCD Contrast xx%	Coffee	Adjustment (ring)	xx: 0 - 100

Function level/display	Key	Function	Display/description
Test M7	Adjustment: LCD backlight		
Test M7 time LCD backlight xx%	Coffee	Adjustment (ring)	xx: 0 - 100
Test M8	Autotest		
Test M8 time *Self test*	Coffee	Autotest	<ul style="list-style-type: none"> • Gearing mechanism test • Grinder test • Cup lift test • Heater and sensor test At the end of the tests, an acoustic signal tells you if the tests were successful or not. <ul style="list-style-type: none"> • 2 acoustic signals - passed test • 10 acoustic signals - failed test If the test was not successful, the relevant error message is shown on the display.
Test M9	Exit		
Test M9 time Exit	Coffee	Exit test mode	

5.2.2. Diagnosis menu - Talea Ring and Ring Plus

Getting started:

- Keep the menu key pressed for approx. 2 seconds until "Cancel" appears in the display.
- Then press the menu key, steam key, aroma and hot water key in that order.

Menu	Address	Parameters	Comment
1. Product counters	1.1	Total Products N°	Total amount of coffee used since production
	1.2	Total N° of Espresso N°	Total quantity of espresso used since production
	1.3	Total ml of Espresso ml	Amount of water used in ml for the Espresso program since production
	1.4	Total N° of Coffee N°	Number of coffees since production
	1.5	Total ml of Coffee ml	Amount of water used in ml for the Coffee program since production
	1.6	Total N° of L.Coffee N°	Number of long coffees used since production
	1.7	Total ml of L.Coffee ml	Amount of water used in ml for the Long Coffee program since production
	1.8	Total N° of Water N°	Number of hot water deliveries since production
	1.9	Total ml of Water ml	Amount of water used in ml for the Hot Water program since production
2. Totalcounters	2.1	Water S.L Descale N°	Current descaling counter counts the amount of water flowed through since the last descaling
	2.2	Water s. 1 Descale ml	Last descaling interval
	2.3	Water s. 2 Descale ml	2. Last descaling interval
	2.4	Water s. 3 Descale ml	3. Last descaling interval
	2.5	Water S. Production ml	Total amount of water in ml for all drinks made since production
	2.6	Descaling N° N°	Number of descaling processes carried out since production
	2.7 B.U	Cleanings N° N°	Number of cleaning cycles carried out since production
	2.8 Water	Filters N° N°	Number of water filter resets carried out

Menu	Address	Parameters	Comment
3. Errors	3.1 Errors List	List	Error memory (20)
	3.2 Clear all NO	No/Yes	Reset error memory
4. Products Settings	4.1 Espresso Settings 4.2 Coffee Settings 4.3. Coffee Settings	4.1(2,3).1 Product Qty (pulses)165	Stored number of pulses for the cup capacity
		4.1(2,3).2 Aroma (1,2,3)	Aroma setting (1 mild, 2 medium, 3 strong)
		4.1(2,3).3 Prebrewing (1,2)	Prebrewing (0: off, 1: normal, 2: long)
		4.1(2,3).4 Temperature °C °C	95 - 105 Can be changed by +/- 3 °C in the customer menu
5. System settings	5.1 Fw Version v.3.00.05"		
	5.2 Fw Boot Version v.05		
	5.3 Setup Aroma (pulses) N°	60 -150 (autodose from V.2.00.08)	A dosage quantity adjustment should be carried out here up to V.2.00.08. From V.2.00.08, the value is corrected automatically by the autodose function, depending on the type of coffee or degree of grinding.
	5.4 Temp. Standby °C 65	50 - 80	Temperature level of the heater in standby
	5.5 Temp. Cup °C 78	70 - 85	Temperature control (brewing temperature)
	5.6 Standby timeout 180	15 - 180	Selected standby time from the customer menu
	5.7 Flowrate (l/h) 15	10 - 20	Flow speed during hot water dispensing
	5.8 Language Select	11 languages	Language setting (from the customer menu)
	5.9 Water Hardness 3	1 - 4	Water hardness setting (from the customer menu)
	5.10 LCD Backlight 50	0 - 100	Setting for the display's backlight
	5.11 LCD Contrast 50	0 - 100	Contrast setting (brightness of the lettering) in the display

Menu	Address	Parameters	Comment
5. System settings	5.12 Grounds Limit 13	5 -25	Dreg stop (number of cycles until the message "Empty dreg drawer" appears)
	5.13 Grounds Left N°	1 - 13	Number of remaining uses until the message "Empty dreg drawer" (counts the uses from 13 downwards)
	5.14 Grounds Warning 8	1 - 13	If the value in Grounds Left and Grounds Warning are identical, (e. g. 3), the message empty dreg drawer appears (after 10 uses since the last reset the dreg drawer can be emptied but does not have to be (if the drawer is emptied, the Grounds Left counter is reset [set to 13 Grounds Limit]). The dreg drawer must be emptied at Grounds left = 0
	5.15 Cup Warm Power 0	0,1	Cup warmer 0: Off, 1: On

5.3.1 Test mode - Talea Touch

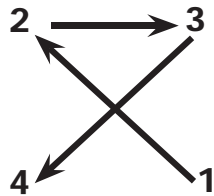

Getting started with test mode:

- Turn on the appliance (wait for hourglass to appear).
- Within 3 seconds, type in an X in the corner of the display in the sequence shown (beginning at the bottom right).

Navigation:

- Use the "next" key to move through the menu levels.
- You can use the three keys on the lower edge of the display to start up to three functions for each menu level.

Function group t.0 - software version

Displays the current CPU software version.

Function group t.1 - Brewing unit

bu_current (mA)	= 3	Power consumption in mA
bu_home	= OFF	ON - Microswitch (original position) Gearing mechanism activated
bu_work	= ON	ON - Microswitch (brew position) Gearing mechanism activated
bu_present	= ON	ON - Microswitch brewing unit (inserted) activated
bu_dregdrawer	= ON	ON - Dreg drawer reed switch
bu_door	= ON	ON - Reed switch for doors
bu go home:		Brewing unit moves to original position
bu go work:		Brewing unit moves to brewing position
bu stop:		Stop brewing unit

Function group t.2 - Heater

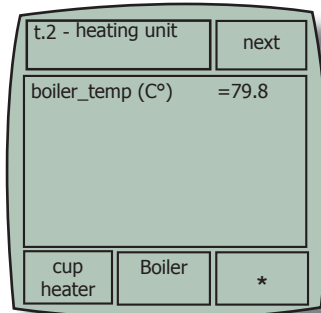

boiler_temp (C°) Temperature recorded by the temperature sensor.

cup heater: Cup warmer heats up
boiler: Continuous-flow heater heats up
*: no function

Function group t.3 - Water/steam system

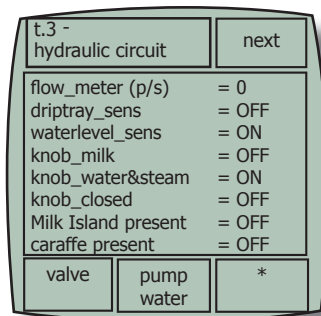

flow_metre(p/s): Flowmetre pulses (12-17)
driptray_sens: ON - Residual water tray full
waterlevel_sens: ON - Water tank full
knob_milk: ON - Hot water / steam valve in pos. Milk Island
knob_water/steam ON - Hot water / steam valve in pos. hot water/steam
knob_closed: ON - Hot water / steam valve in pos. closed
milkisland present: ON - Milk Island adapter detected
carafe present: ON - Carafe microswitch activated

valve: Magnet valve activation
pump water: Pump activation
*: no function

Function group t.4 - Grinder

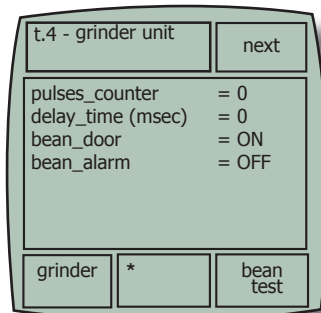

pulses_counter: Coffee grinder pulses (Hall sensor)
delay_time (msec) Coffee grinder pulse msec/pulse
bean_door: ON - Reed sensor bean cover activated
bean_alarm: ON - Beans low (speed exceeded)

grinder: Coffee grinder activation
*: no function
bean_test: The machine starts grinding and the relevant message is shown next to bean_alarm (ON/OFF)

Function group t.5 - Cup lift

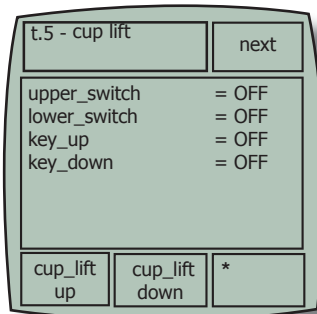

upper_switch: ON - Microswitch cup lift (top end position)
 lower_switch: ON - Microswitch cup lift (bottom end position)
 key_up: ON - Cup lift sensor UP activated
 key_down: ON - Cup lift sensor DOWN activated

cup_lift up: Cup lift moves upwards
 cup_lift down: Cup lift moves downwards
 *: no function

Function group t.6 - Dosing

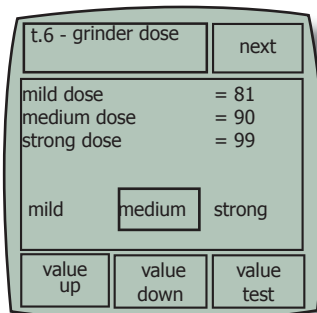

mild dose = medium dose -10% (fix)
 medium dose Range 60 - 150 (value up/down)
 strong dose = medium dose +10% (fix)

mild Setting for the dosing quantity test
 medium Setting for the dosing quantity test
 strong Setting for the dosing quantity test

value up: Brewing unit moves to original position
 value down: Brewing unit moves to brewing position
 value test: Stop brewing unit

Function group t.7 - Dreg counter

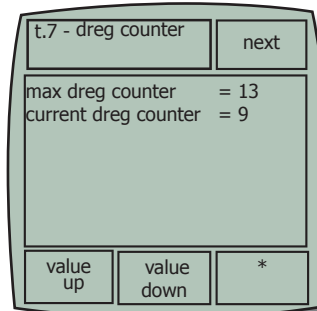

max dreg counter: Maximum number of cycles until "Empty dreg drawer" message appears
 current dreg count Running dreg counter

value up: increase the number of cycles
 value down: reduce the number of cycles
 *: no function

Function group t.8 - Let steam out

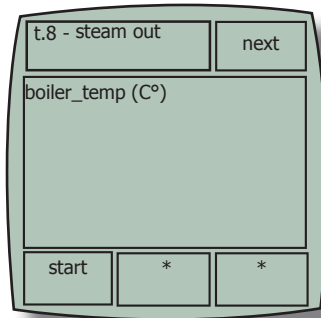

boiler_temp (C°): current boiler temperature

start: Starts the steam out procedure
 *: no function
 *: no function

Function group t.8 - Let steam out

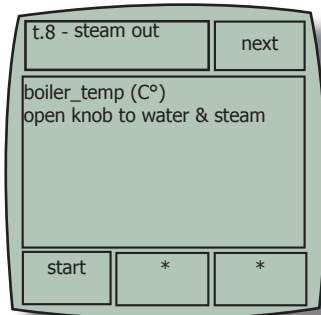

boiler_temp (C°): current boiler temperature
 open knob to w/st: Instruction to open hot water / steam valve

start: Starts the steam out procedure
 *: no function
 *: no function

Function group t.8 - Let steam out

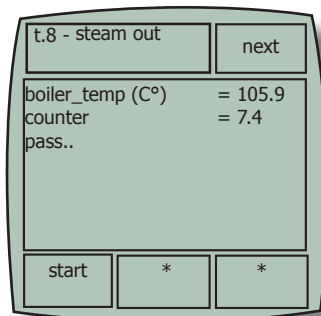

boiler_temp (C°): heats up to approx. 110 (C°)
 counter: counts from 10 to 0 (steam out time)
 pass: Steam out procedure completed

start: Starts the steam out procedure
 *: no function
 *: no function

5.3.2 Diagnosis menu - Talea Touch

Getting started:

- Turn on the appliance and within the first 3 seconds after the hourglass appears, touch the display in the corner with your finger in the following sequence (top left, top right, bottom left, bottom right = Z)

Menu level						Comment
1	2	3	4	5	6	
Counters	D1.1.counters	Water counters	D1.1.1. total counters	Water s. prod.		Amount of water since first use
						Water since the last descaling
		Descaling cycles		since last DS.		Water 2. last descaling
				since sec. last DS.		
		Water filter		since third. last DS.		Number of descaling cycles carried out
				n° of DS. Cycles		
		Cleaning cycles		water since last filter reset		Number of filters changed = number of filter initialisations
				water filters since prod.		
		error counters		n° of cleaning cycles		Water since the last cleaning cycle
				water since last cleaning		
		current error				Error since last service
		error since prod.				Error list (see list)
		error since last service				
		error log				

D1. Diagnostics menu		Settings							
Product settings		Product settings							
error	product counters	D1.2.1A Product settings							
		D1.1.3. product counters							
	reset errors last service	reset error log	espresso	coffee	long coffee	product total		yes / no	Delete errors
								yes / no	Delete errors
D1.1.2A.1		reset errors last service							Product counters
D1.1.2A.2		reset error log							Product counters
D1.1.2A.3		espresso							Product counters
D1.1.2A.4		coffee							Product counters
D1.1.2A.5		long coffee							Product counters
D1.1.2A.6		product total							Product counters
D1.1.2A.7		beverage settings			espresso coffee long coffee				
D1.1.2A.8		D1.2.1A Product settings							
		prebrewing							
		temperature							
		aroma							
		coffee volume +/-							
		prebrewing							
		temperature							
		aroma							
		coffee volume +/-							
		prebrewing							
		temperature							
		aroma							
		coffee volume +/-							
		medium							
		strong							
		off							
		low							
		medium							
		high							
		mild							
		medium							
		strong							
		preground							
		+/-							
		no function							
		low							
		medium							
		high							
		no function							
		+/-							
		Cup capacity							
		No function							
		Coffee temperature for rinsing							
		No function							
		Amount of water for rinsing							

Menu level						Comments / conversion	
1	2	3	4	5	6		
	Product settings	D1.2.1A Product settings	set clock	current time	h/min	Programming current time	
				time format	24hr - am/pm	Program. 12 / 24 hour display	
			date settings	time/date settings	current date	yy/mm/dd	Program. Date Year/Month/Day
					date format	select (3)	Program. Date format
			standby setting	time/date settings	15 min		Standby 15 min after use
					30 min		Standby 30 min after use
					1h		Standby 1 hour after use
					3h		Standby 3 hours after use
			machine on/off	time/date settings	interval 1	h/min	Switching time 1 (ON/OFF time)
					interval 2	h/min	Switching time 2 (ON/OFF time)
					interval 3	h/min	Switching time 3 (ON/OFF time)
	maintenance setting	Special settings	week day setting	Monday-Sunday	Allocation of the switching time/day		
			Product counters				
	D1.2.1B	Special settings	Factory settings			Initialise factory settings	

D1. Diagnostics menu		Settings		system settings		D1.2.A. System setting		D1.2.B	
grounds limit	(13)								Maximum dregs
actual grounds	+/- (counts from 13 upwards)							+/- (1-26)	Dreg counter
warning grounds	(8)							+/- (1-13)	If this value is the same as the dreg counter then "empty dreg drawer" appears Coffee can still be dispensed The counter is reset when emptied
delay reset grounds	+/- (1-100) 50 = 5 sec								The time the dreg counter should be reset to when the dreg drawer has been removed
cup temperature	(78)							+/- (70-85)	Coffee temperature (in the cup)
coffee temp	temp.active (112)							+/- (80-140)	Boiler temp. when coffee is dispensed
								+/- (80-140)	Boiler temp. when coffee is not being dispensed
steam temperature	temp.active (145)							+/- 130-150)	Boiler temp. when steam is used
								+/- (130-150)	no function
hot water temperature	(90)							+/- (70-120)	Boiler temp. when hot water is dispensed
medium dose	(80-100)/(auto dose)							+/- (50-150)	Grinder pulse with medium dose From V.....:autodose (automatic setting)
hot water flowrate	+/- (13-18) (18)								Flow rate
on/off (ON takes over the current date)									Date setting service

5.4. Error messages

Function group M3: Error log

The following will be displayed at this program level:

- the last 20 faults
- date when the fault occurred

CODE	BRIEF DESCRIPTION	DESCRIPTION / POSSIBLE FAULT
FAULT IN THE COFFEE GRINDER		
01	Coffee grinder blocked	No Hall sensor pulses: <ul style="list-style-type: none"> • Sensor/cable defective • Gearing mechanism defective • Coffee grinder blocked • The motor is not driven
BREWING UNIT FAULT		
03	TORQUE_FAULT_FWD	Torque exceeded when moving to the brewing position
	TIMEOUT_FWD	Time exceeded when moving to the brewing position
	TIMEOUT_FWD_DOWN	Time exceeded when releasing the start position microswitch
	HOME_WHILE_WORKING	Activates the start position microswitch when moving up to the brewing position
04	TORQUE_FAULT_RWD	Torque exceeded when returning to the start position
	TIMEOUT_RWD	Time exceeded when returning to the start position
	WORK_WHILE_HOMING	Activates the brewing position microswitch when moving to the start position
16	HOME_AND_WORK_PRESSED	Both gear microswitches operated at the same time
FAULT IN THE WATER CYCLE		
05	No flowmetre pulses when the pump is activated	<ul style="list-style-type: none"> • Flowmetre defective • Pump defective • Lead shifted
06	Hot water / steam valve vent sensor board fault	More than one sensor is ON at the same time
FAULT WITH THE TEMPERATURE CONTROLLER		
10	SENSOR1_SHORT	Short-circuit in the continuous-flow heater sensor
11	SENSOR1_OPEN	Interruption in the continuous-flow heater sensor
14	TEMPERATURE_BO_TOO_HIGH	Temperature exceeded on the continuous-flow heater
15	TEMPERATURE_BO_OUT_CONTROL	Coffee boiler temperature controller is not working (i.e. no response to signals: e.g. the continuous-flow heater is switched on but the temperature does not increase)
GENERAL FAULTS		
19	No zero crossing	Power supply fault
20	Cup lift fault	Both limit switches operated at the same time

CHAPTER 6

STANDARD CONTROLS

6.1. Repair plan

	Action
1	Visual check (transport damage)
2	Recording the appliance data
3	Functional check / fault analysis
4	Opening the appliance
5	Visual check (leaks)
6	Checking the mechanical procedure (functional test)
7	Repairing the faults occurred
8	Checking the modifications
9	Service activities according to the Service plan
10	Cleaning inside
11	Functional test (when the appliance is open / leak test)
12	Assembly
13	End test according to the Test plan
14	Let steam out (Winter)
15	Exterior cleaning
16	Lubricating the brewing unit
17	Insulation test HG 701
18	Documentation

6.2. Service plan

R = Replace

C = Clean

VC = Visual check

HT = Hearing test

D = Descale

A = Adjust





Parts	Action	Resources
Water filter	C/R	
Lip seal / water tank	R	
Cream valve	C	
Valve spring	R	
O ring valve pin	R	
O ring valve pin	R	
Sieve (brewing unit)	C/VC	Fat solvent
Hose connections	VC	
Pump	VC/HT	
Gears	HT/VC	
Coffee grinder	C/A	Vacuum cleaner / brush
Water route	D	Descaler (Saeco)
Hot water / steam valve	VC/R	
Water drain (valve pin)	C	Fat solvent / brush

6.3. Final control





Test	Procedure	Resources	Specification	Tolerance
Cup capacity	2-3 cups with the Espresso setting	Measuring beaker	Same amount	15%
Cup capacity	2-3 cups with the Coffee setting	Measuring beaker	Same amount	15%
Noise levels			Standard noise experience value	
Cream quantity	Carefully blow into the cup until the cream separates		The cream covering then has to re-close completely	
Cream colour			Hazel brown marbled	
Temperature	Reading taken in coffee flow	Temperature measuring device	84°C	± 4°C
Grinding level	Check the grain size of the ground coffee		See the training course	
Hot water	Dispense hot water			
Steam function	Dispense steam			
"Water low" message	Remove the tank		"Fill / insert water tank"-message	
"Dreg drawer missing" message	Remove the dreg drawer		"Dreg drawer missing" message	
"Beans low" message	Start coffee program - dreg drawer empty		"Beans low" message	

CHAPTER 7 DISASSEMBLY

7.1. SBS / dispenser

 <p>1</p>	 <p>2</p>	<p>To disassemble the SBS</p> <p>Fig.1</p> <ul style="list-style-type: none"> Remove the SBS rotary knob. <p>Fig.2</p> <ul style="list-style-type: none"> Unscrew the fixing screw. Remove the bracket of the SBS rotary knob. <p>Fig.3</p> <ul style="list-style-type: none"> Unscrew the screws shown. <p>Fig.4</p> <ul style="list-style-type: none"> Remove the drain valve.
 <p>3</p>	 <p>4</p>	

7.2. Housing

 <p>1</p>	<p>To disassemble the housing - front and upper parts</p> <p>Fig.1</p> <ul style="list-style-type: none"> Remove the cover of the coffee container. Unscrew the screw marked in the illustration. Remove the rotary knob from the hot water / steam valve. <p>Fig. 2</p> <ul style="list-style-type: none"> Take out the bean hopper cover sensor. <p>Fig. 3</p> <ul style="list-style-type: none"> Loosen the rear upper part of the housing. <p>Fig. 4</p> <ul style="list-style-type: none"> Fix the upper housing around the bean hopper. Pull the front side under the drain valve forwards. Remove the upper part of the housing. <p>Fig. 5</p> <ul style="list-style-type: none"> Unplug the cup warmer and grounding. 	
 <p>2</p>	 <p>3</p>	
 <p>4</p>	 <p>5</p>	

Caution: if you need to remove the upper part of the housing, start by moving the cup lift to its lowest position then remove the collection tray.

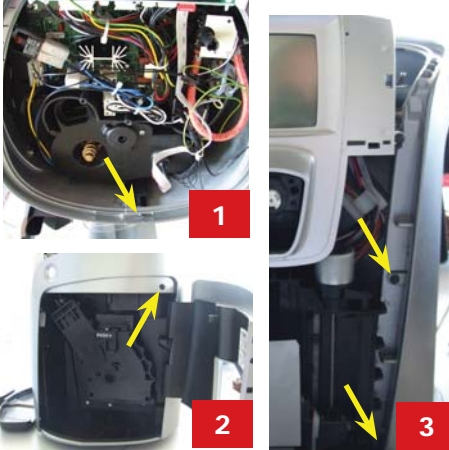
	<p>To disassemble the right side part</p> <p>Fig. 1</p> <ul style="list-style-type: none"> Remove the screw shown. <p>Fig. 2</p> <ul style="list-style-type: none"> Remove the screw shown (not with Odea). <p>Fig. 3</p> <ul style="list-style-type: none"> Remove the screws shown.
---	--

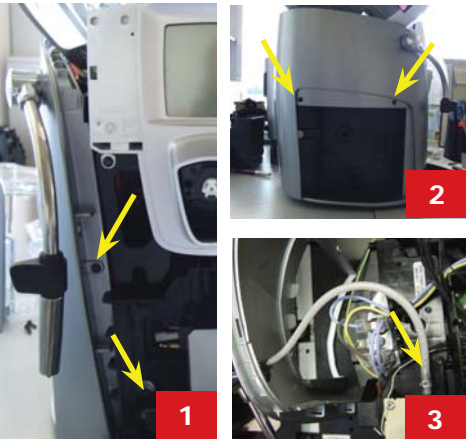
	<p>To disassemble the left side part</p> <p>Fig. 1</p> <ul style="list-style-type: none"> Remove the screws shown. <p>Fig. 2</p> <ul style="list-style-type: none"> Remove the screws shown. <p>Fig. 3</p> <ul style="list-style-type: none"> If required, loosen the hose clamp on the hot water / steam valve and remove the hose.
---	---

	<p>To remove the side panels</p> <p>Fig. 1</p> <ul style="list-style-type: none"> Separate the rear upper side part. <p>Fig. 2</p> <ul style="list-style-type: none"> Grab the side part from underneath and remove.
---	---

7.3. Electronics

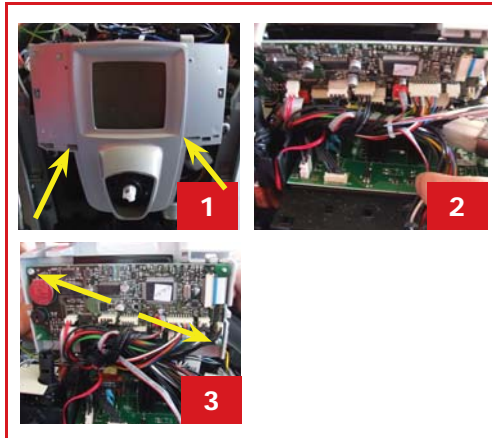
	<p>To disassemble the control board</p> <p>Fig. 1</p> <ul style="list-style-type: none"> Remove the screws shown. Fold the board to the back. <p>Fig. 2</p> <ul style="list-style-type: none"> Loosen the plug contact. <p>Fig. 3</p> <ul style="list-style-type: none"> Remove the screws shown.
---	---

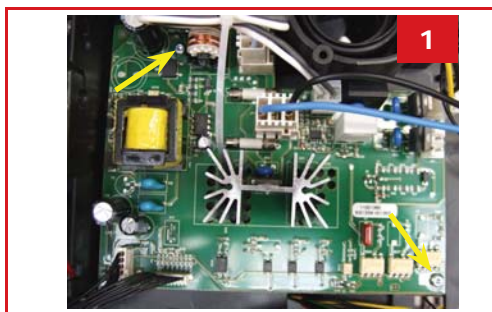
	<p>To disassemble the power board</p> <p>Fig. 1</p> <ul style="list-style-type: none"> Remove the black board's cover. Loosen the plug contact. Remove the screws shown.
--	---

7.4. Boiler's pin

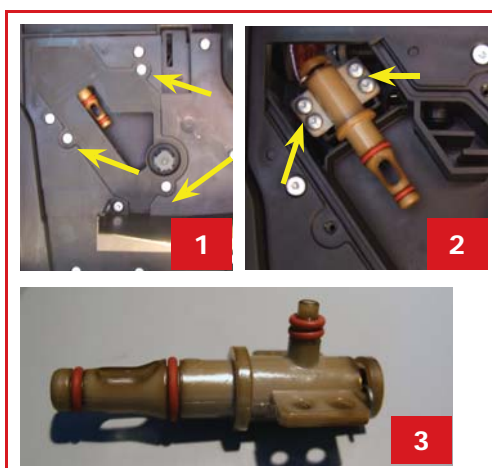
	<p>To disassemble the boiler's pin</p> <p>Fig. 1</p> <ul style="list-style-type: none"> Remove the screws shown. Remove the water channel cover. <p>Fig. 2</p> <ul style="list-style-type: none"> Remove the screws (4 off) shown. <p>Fig. 3</p> <ul style="list-style-type: none"> During assembly, both screws have to be tightened alternately at equal rates to prevent the O-rings from being squeezed.
---	--

7.5. Gear motor device

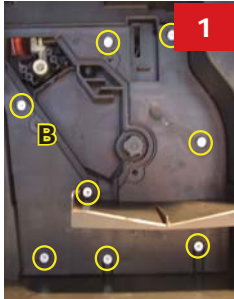
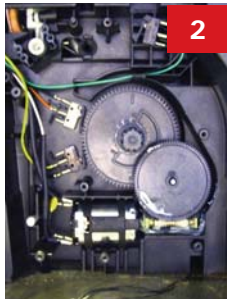
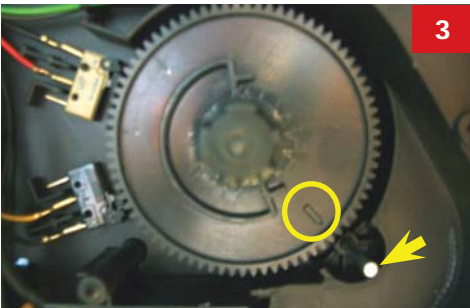
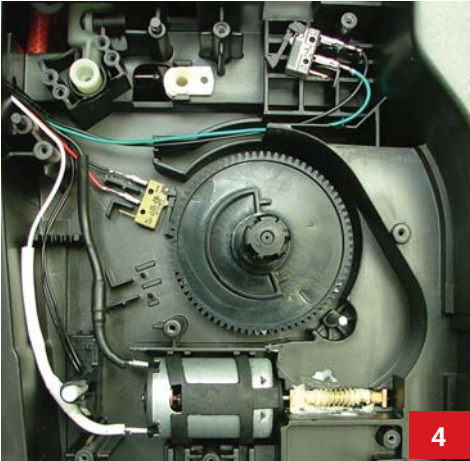
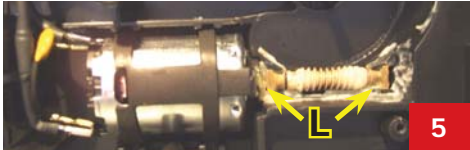
    	<p>To disassemble the gears</p> <p>Fig. 1</p> <ul style="list-style-type: none"> Remove the screws shown. Remove the gear cover. Caution: The sensor of the residual water tray is fitted to the gear cover (unplug). <p>Fig. 2</p> <ul style="list-style-type: none"> If one of the gear wheels is damaged, replace both wheels. If one of the microswitches is defective, always replace both microswitches. <p>Fig. 3</p> <ul style="list-style-type: none"> Gearing mechanism with 2 microswitches. When mounting the large gear wheel, take care that the arrow on the gear wheel is aligned to the axis of the small double toothed gear wheel. <p>Fig. 4</p> <ul style="list-style-type: none"> Single micro version. Install as shown in Fig. 3. <p>Fig. 5</p> <ul style="list-style-type: none"> When assembling the motor, make sure the bearing is fitted correctly (L).
--	---

7.6. Boiler

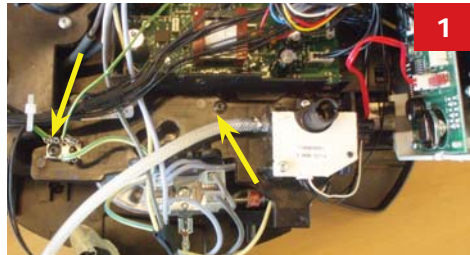

To disassemble the boiler

Fig. 1

- Remove the screws shown.

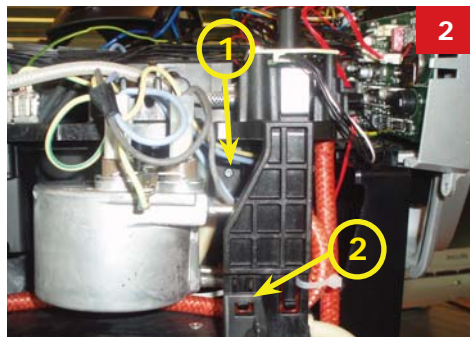

Fig. 2

- Remove the screw shown.
- Release the hook and fold the unit upwards.

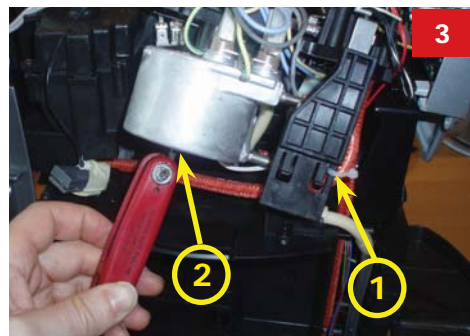

Fig. 3

- Loosen the cable tie.
- Loosen the boiler from the bracket (Allen key).

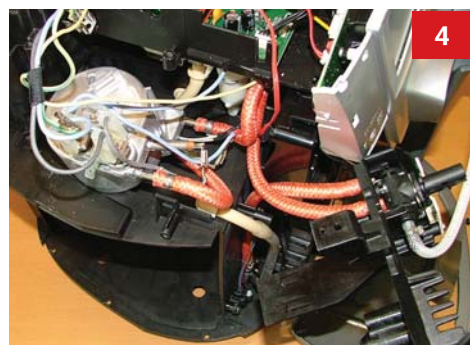
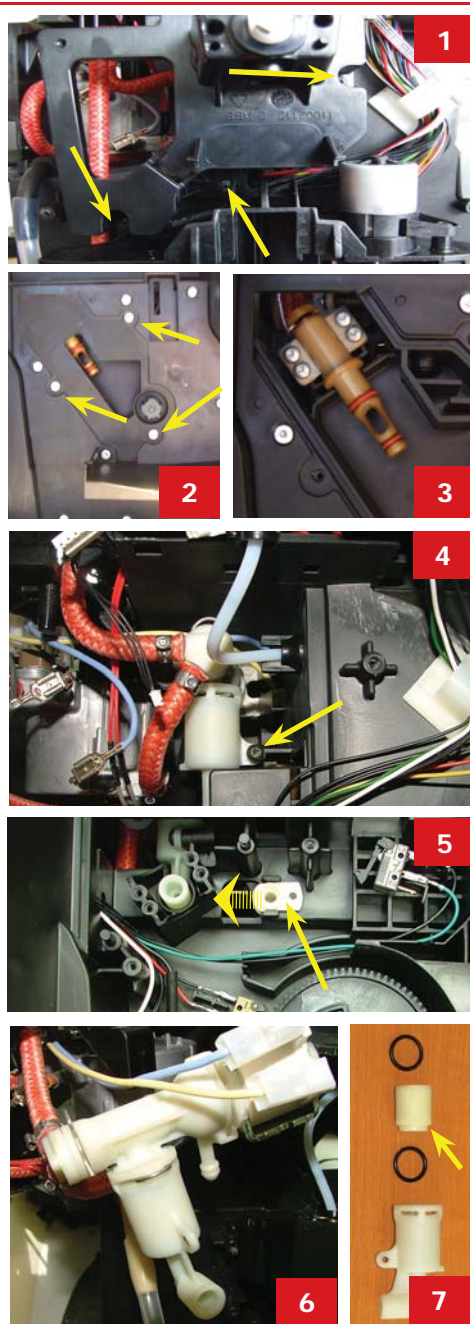

Fig. 4

- Loosen the connections.
- Replace the boiler.

7.7. Solenoid valve / multi-way valve

**To disassemble the solenoid valve / multi-way valve****Fig. 1**

- Remove the screws shown.
- Loosen the coffee dispenser bracket.

Fig. 2 / 3

- Loosen the boiler pin.
- Loosen the boiler's bracket (see section 7.6 / Fig. 1 and 2).

Fig. 4

1. Remove the screw shown.

Fig. 5

- Unhinge the pressure-relief hose.

Fig. 6

- Remove the valve unit.

Fig. 7

- When putting together the 2nd control valve, make sure the graded side is pushed in first.

7.8. Pump

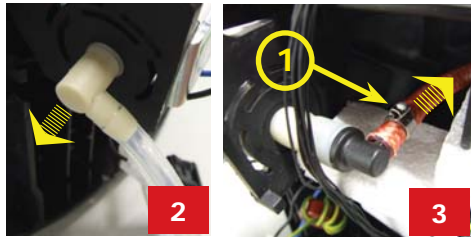
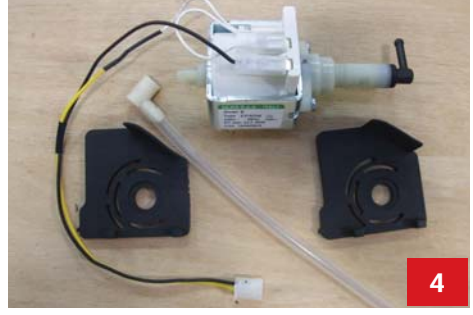
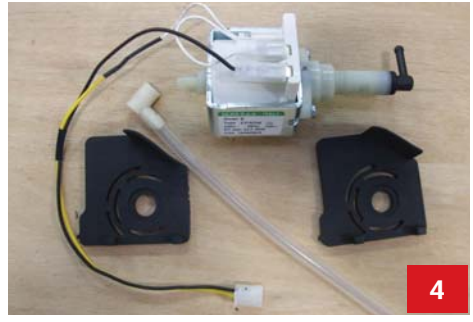
	<p>To disassemble the pump</p>
	<p>Fig. 1</p>
	<ul style="list-style-type: none"> Remove the pump and the pump bracket from the guide.
	<p>Fig. 2</p>
	<ul style="list-style-type: none"> Remove the connecting bracket.
	<p>Fig. 3</p>
	<ul style="list-style-type: none"> Loosen the hose clamp and remove the hose.
	<p>Fig. 4</p>
	<p>1. Disassembled pump unit.</p>

7.9. Hose connections (assembly)

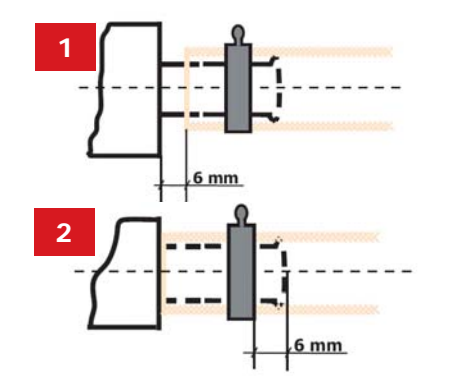
	<p>Hose connection specifications</p>
	<p>Fig. 1</p>
	<ul style="list-style-type: none"> Boiler connection.
	<p>Fig. 2</p>
	<ul style="list-style-type: none"> Other connections.

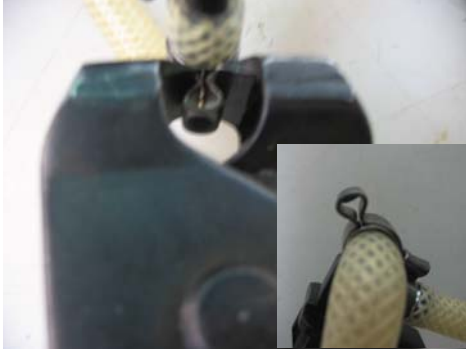
	To replace the hoses
	<p>Fig. 1</p> <ul style="list-style-type: none">• To open the clamp, place the pliers at the front. <p>Fig. 2</p> <ul style="list-style-type: none">• Use pliers to squeeze the clamp.

7.10. Coffee grinder

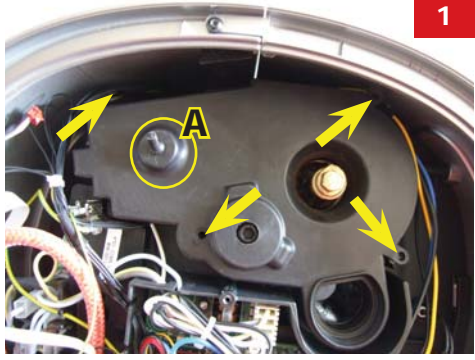
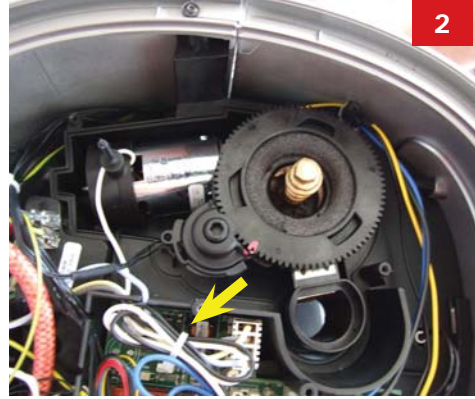
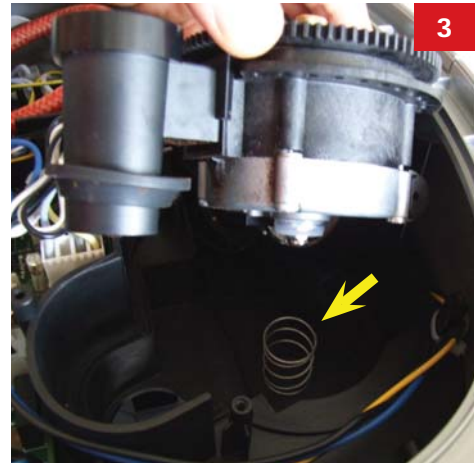
 <p>1</p>	<p>To disassemble the coffee grinder</p> <p>Fig. 1</p> <ul style="list-style-type: none">• Remove the screws shown.• Loosen the motor mounting bracket (A).• Remove the cover.
 <p>2</p>	<p>Fig. 2</p> <ol style="list-style-type: none">1. Loosen the cable tie.
 <p>3</p>	<p>Fig. 3</p> <ul style="list-style-type: none">• When installing, take care that the spring is fitted correctly in the centre of the coffee grinder axis.

7.11. Grinders

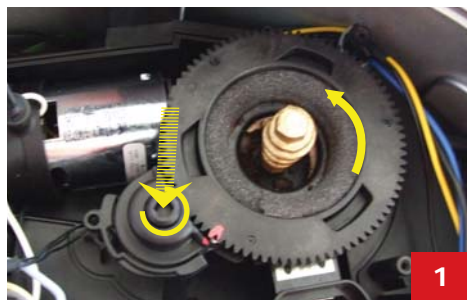

1



2



3

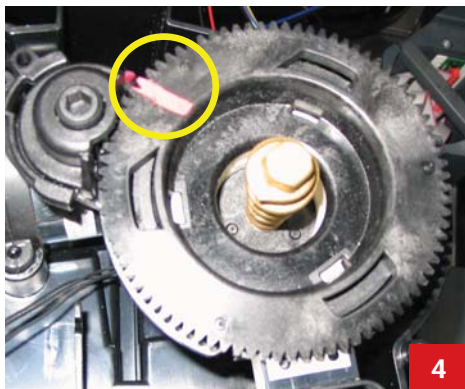

4

To disassemble/adjust the grinding disc

Fig. 1

- Press against the grinding level setting axis and then turn the grinding disc support anticlockwise until it stops, then remove it.

Fig. 2

1. Turn the grinding disc anticlockwise out of the support.

Fig. 3

- Turn the grinding disc anticlockwise out of the support. The bayonet connections can be accessed from the rear side.

Fig. 4

1. In the start position, both markings must be aligned.

7.12. Adjustment of coffee grinder

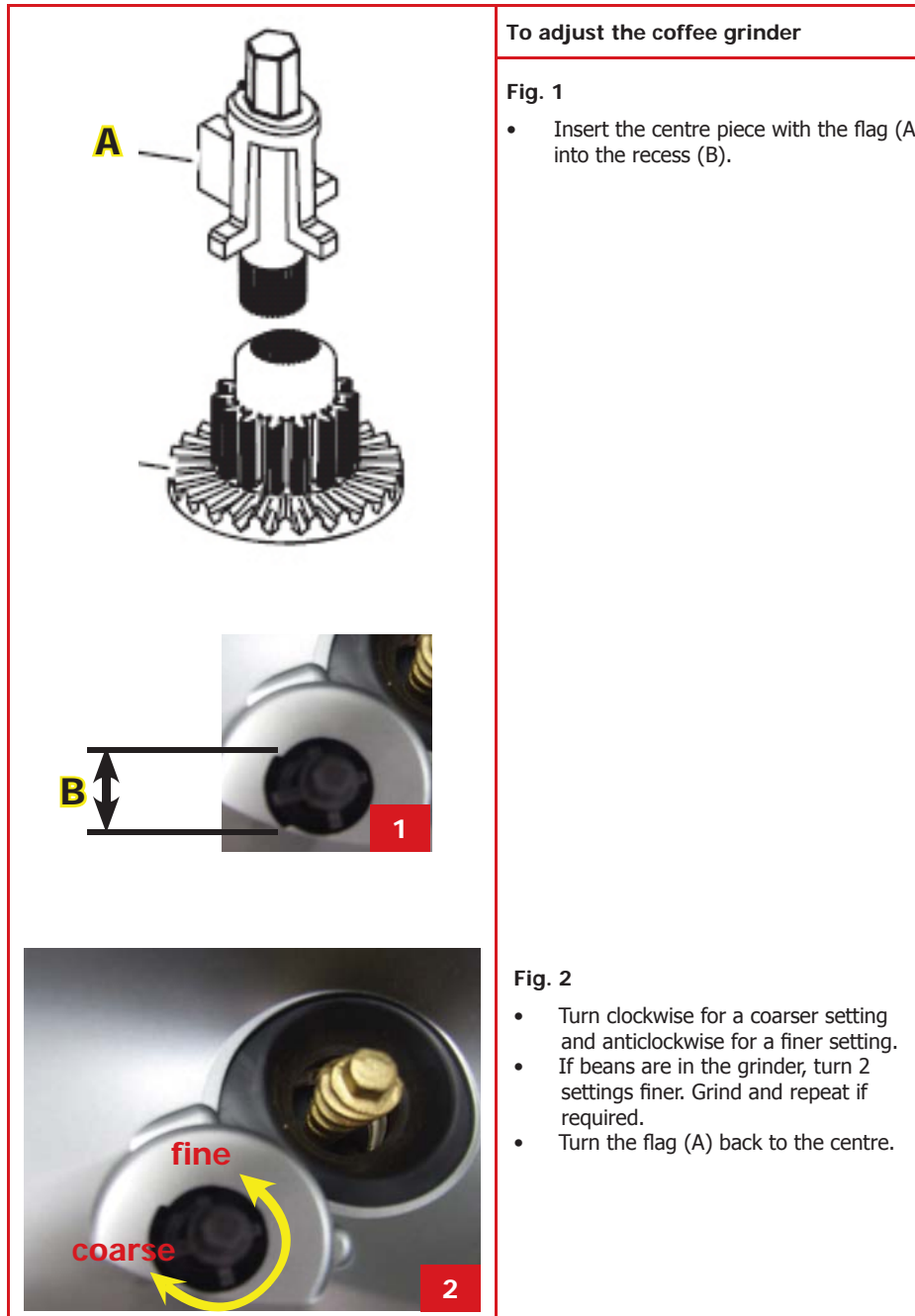

7.13. Cup lift

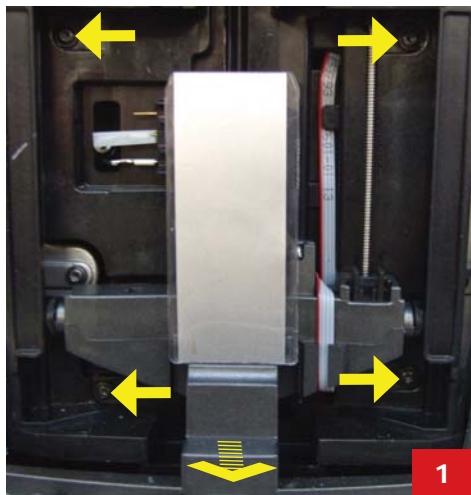

To disassemble the electrical cup lift

Fig. 1

- Remove the screws shown.
- Loosen the motor mounting bracket (A).
- Remove the cover.

Fig. 2

1. Loosen the cable tie.



Fig. 3

- When installing, take care that the spring is fitted correctly in the centre of the coffee grinder axis.

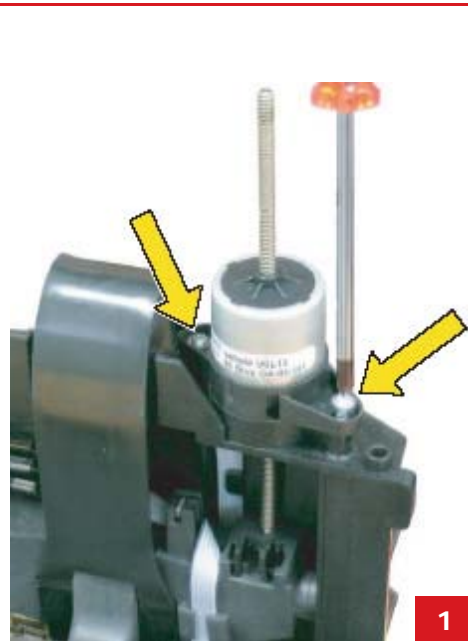

**To disassemble the electrical cup lift****Fig. 1**

- Remove the screws shown.

**Fig. 2**

- Remove the securing clips.
- Loosen the sensor cable.
- Unhinge the cup lift.

CHAPTER 8

NOTES

CHAPTER 9

WATER SYSTEM DIAGRAMS

Odea Go

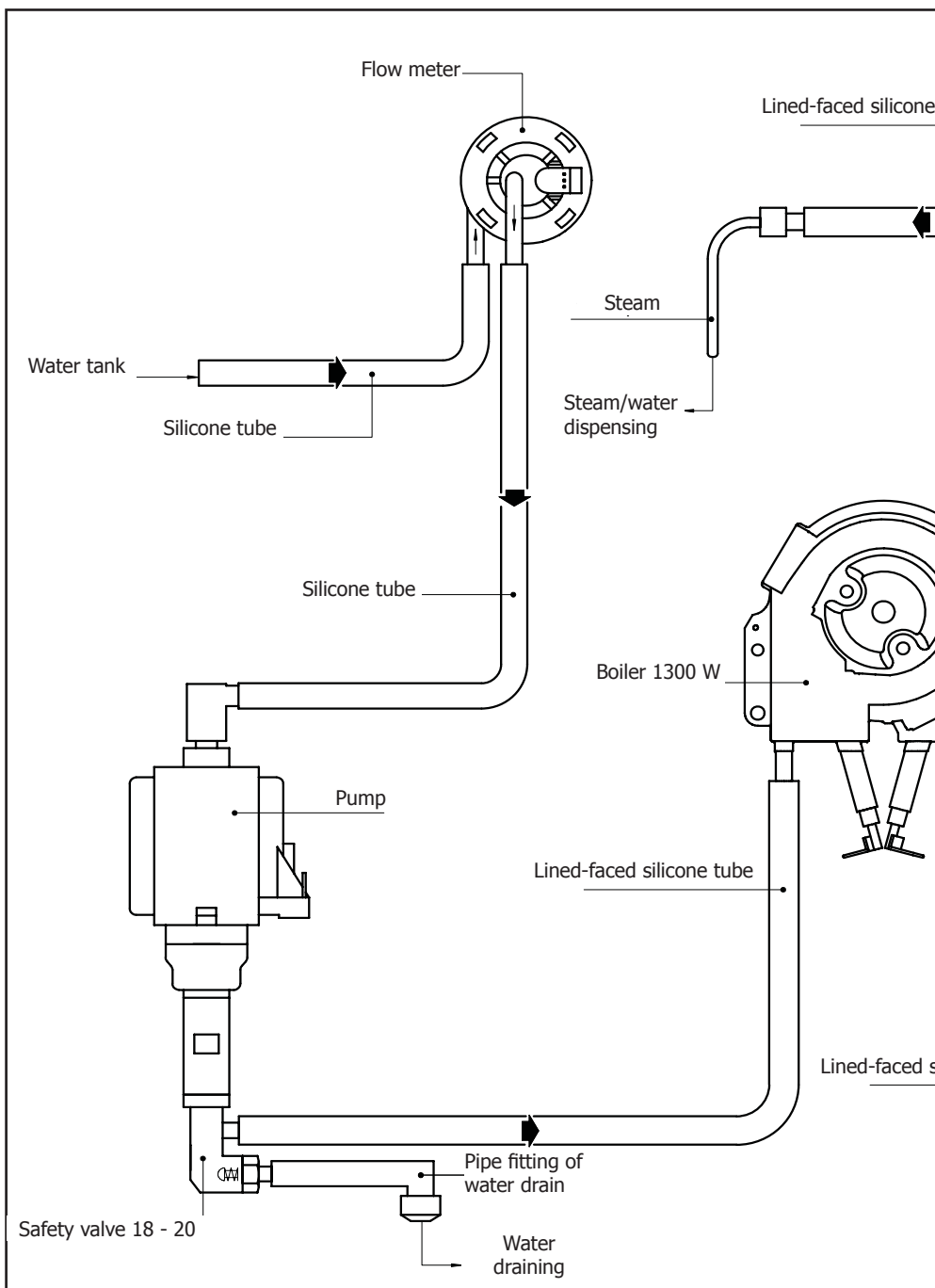

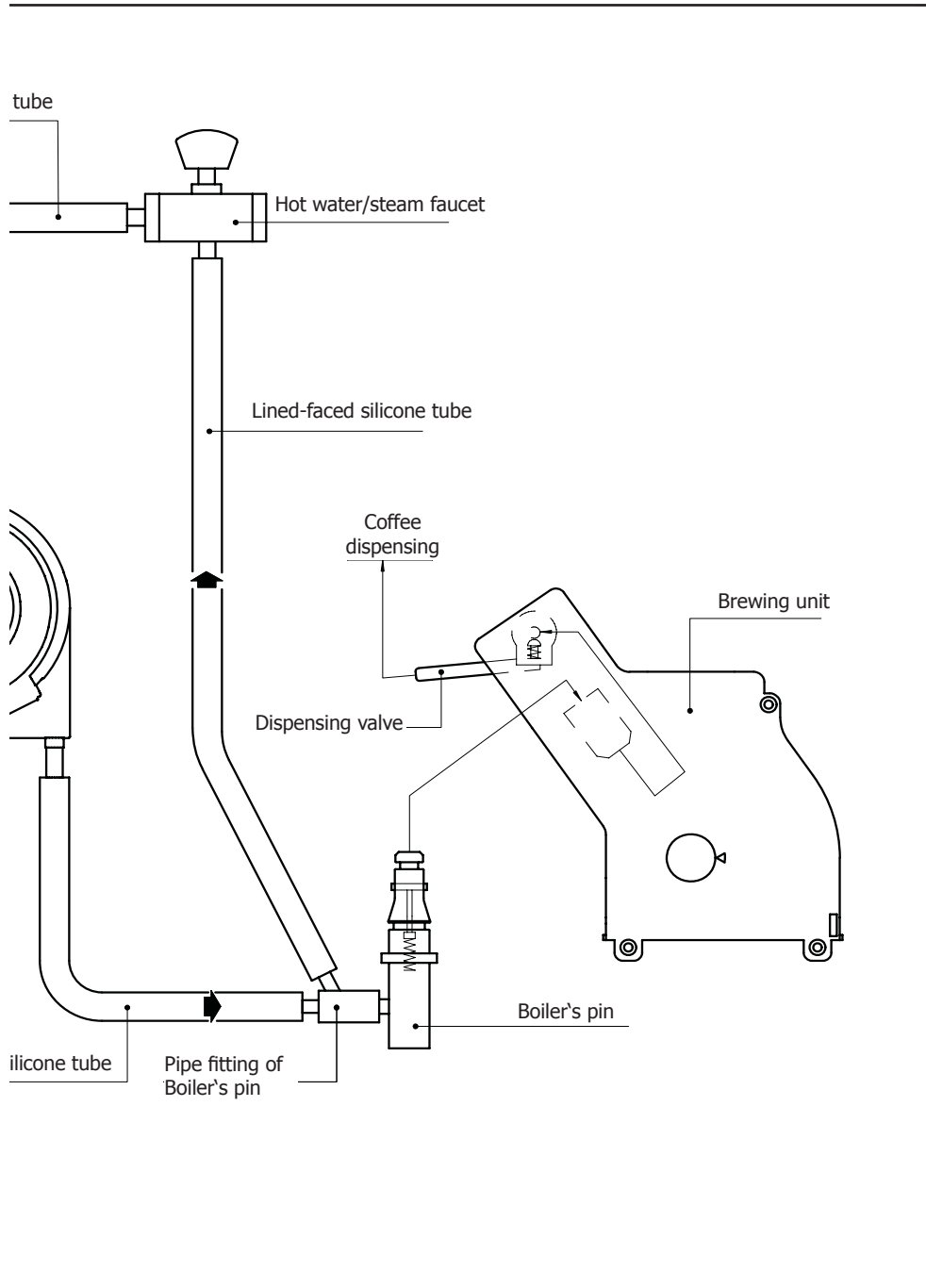

Odea Giro Plus, Giro

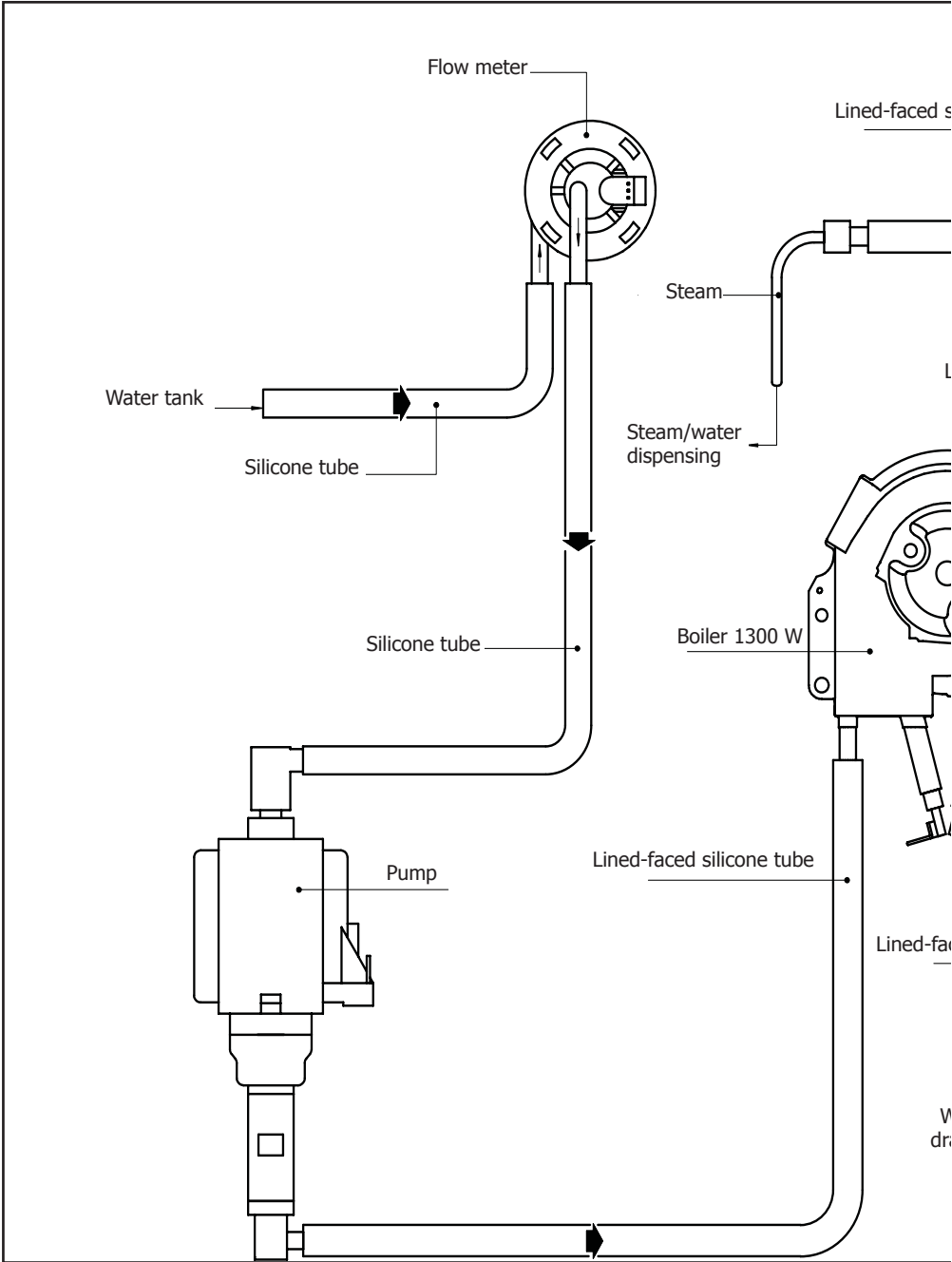

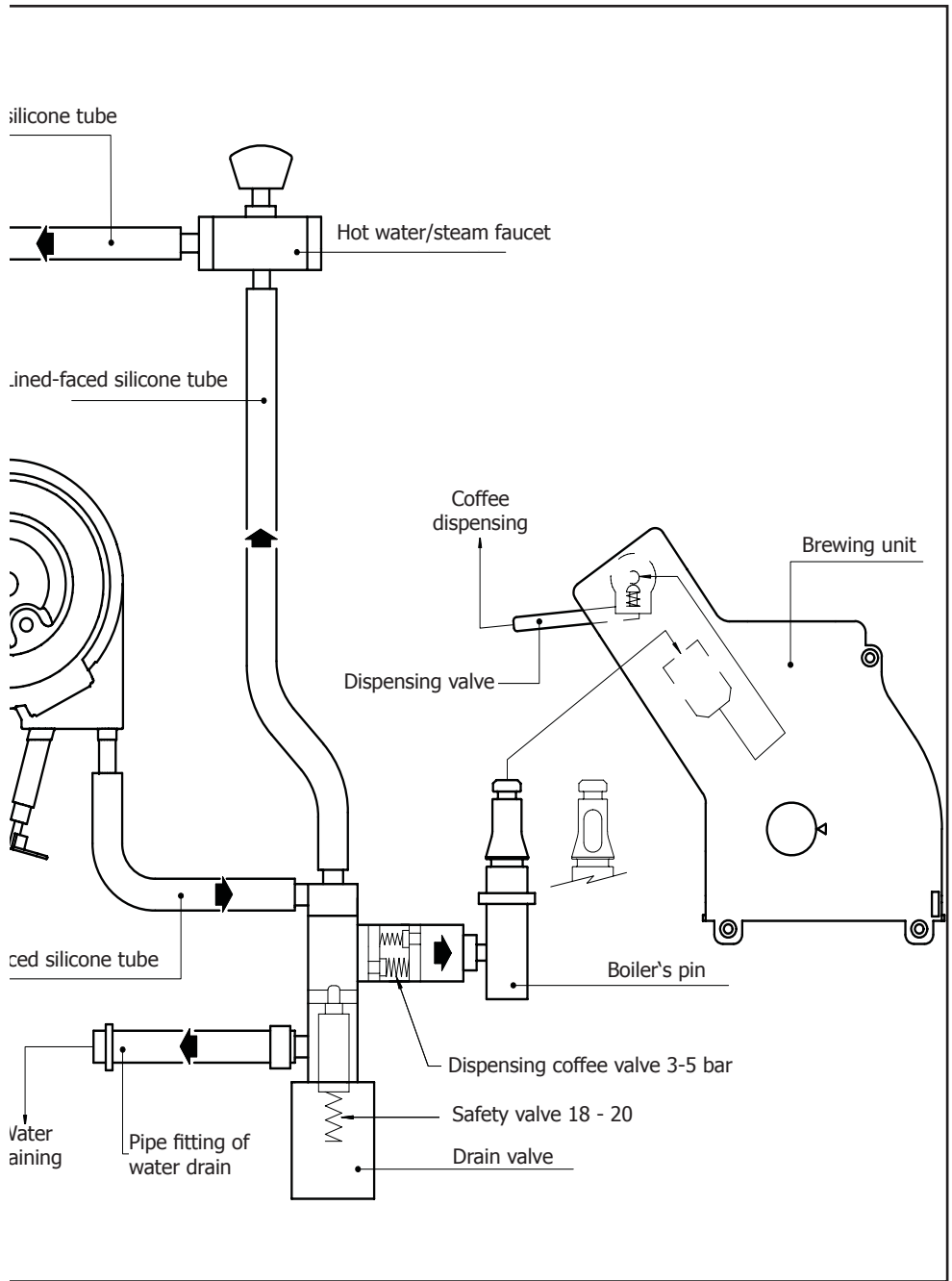

Talea

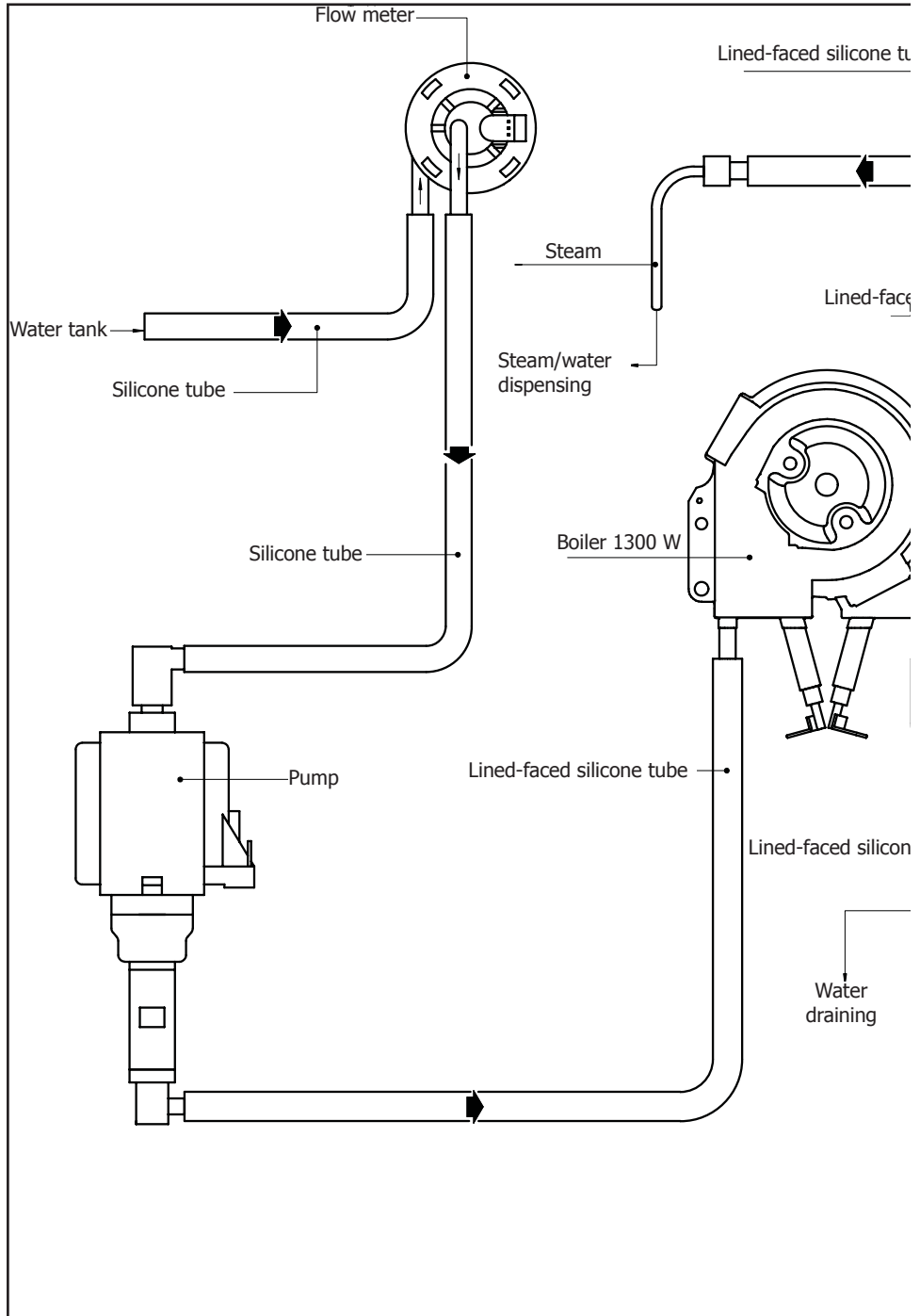

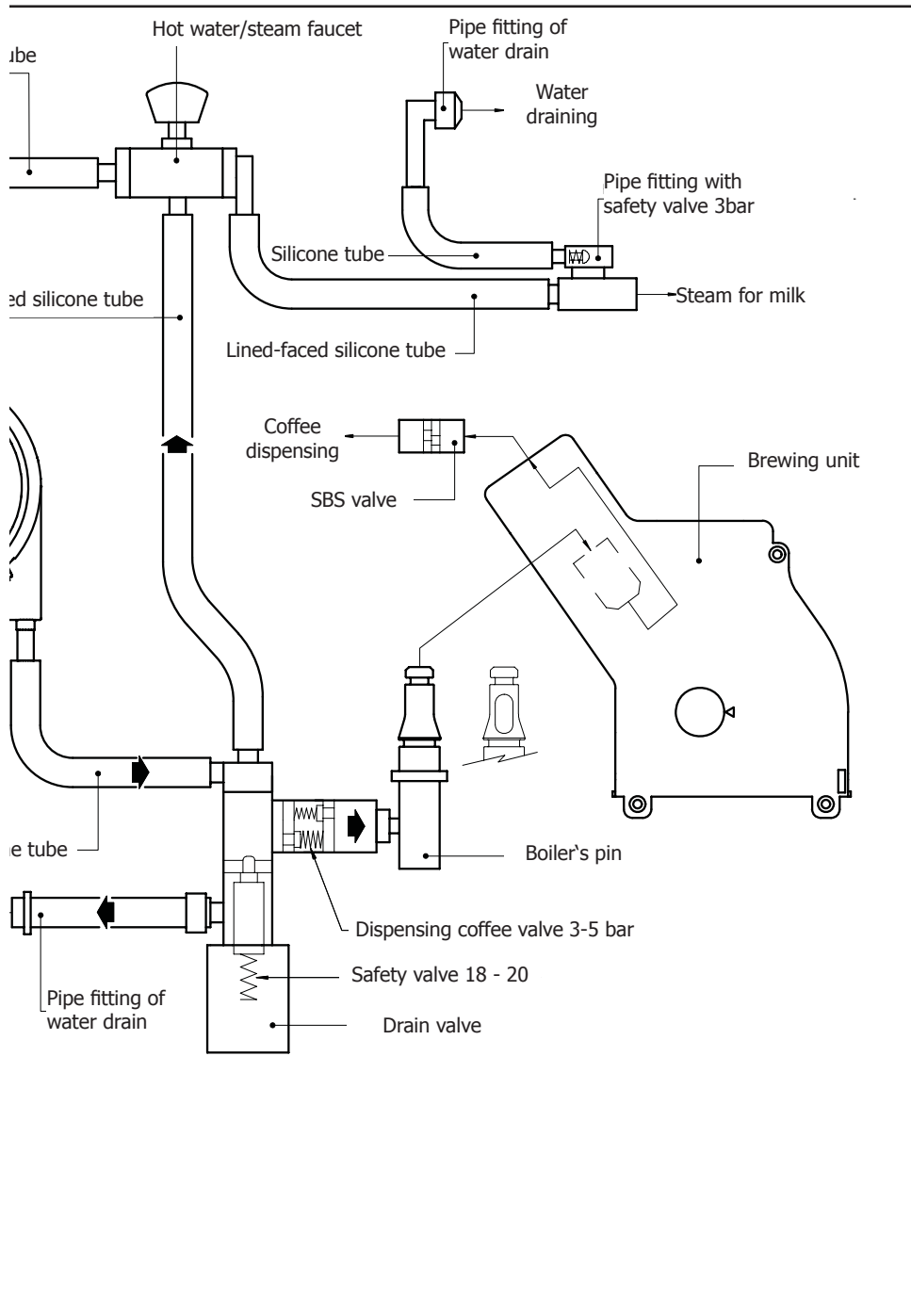

CHAPTER 10

WIRING DIAGRAMS

Odea Go

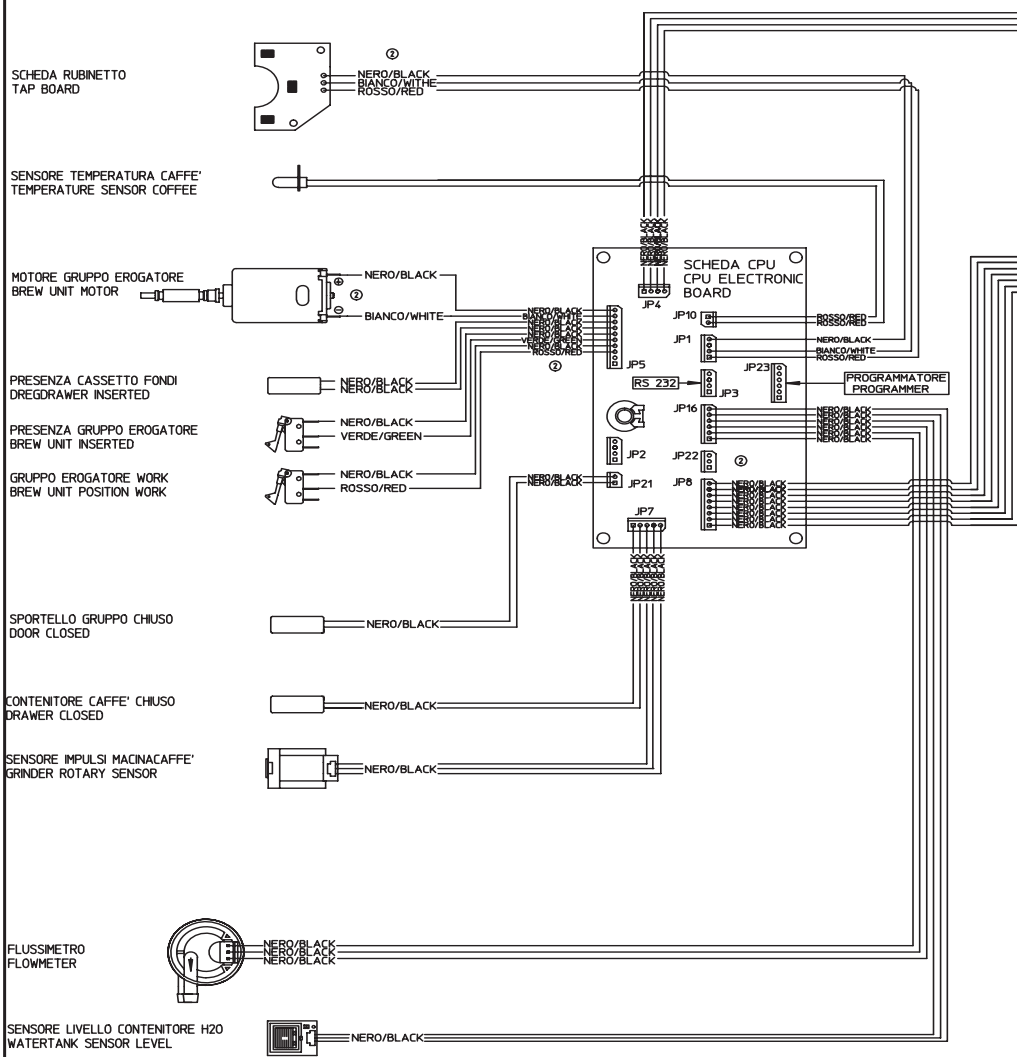

① **NOTA:**
 LA VERSIONE 120V DIFFERISCE DALLA 230V SOLO PER IL COLORE DEI CAVETTI DI TERRA: VERDE AL POSTO DEL GIALLO-
 120V VERSION DIFFERS FROM THE 230V VERSION ONLY WITH DIFFERENT CABLE COLORS: GREEN IN PLACE OF YELLOW-GR

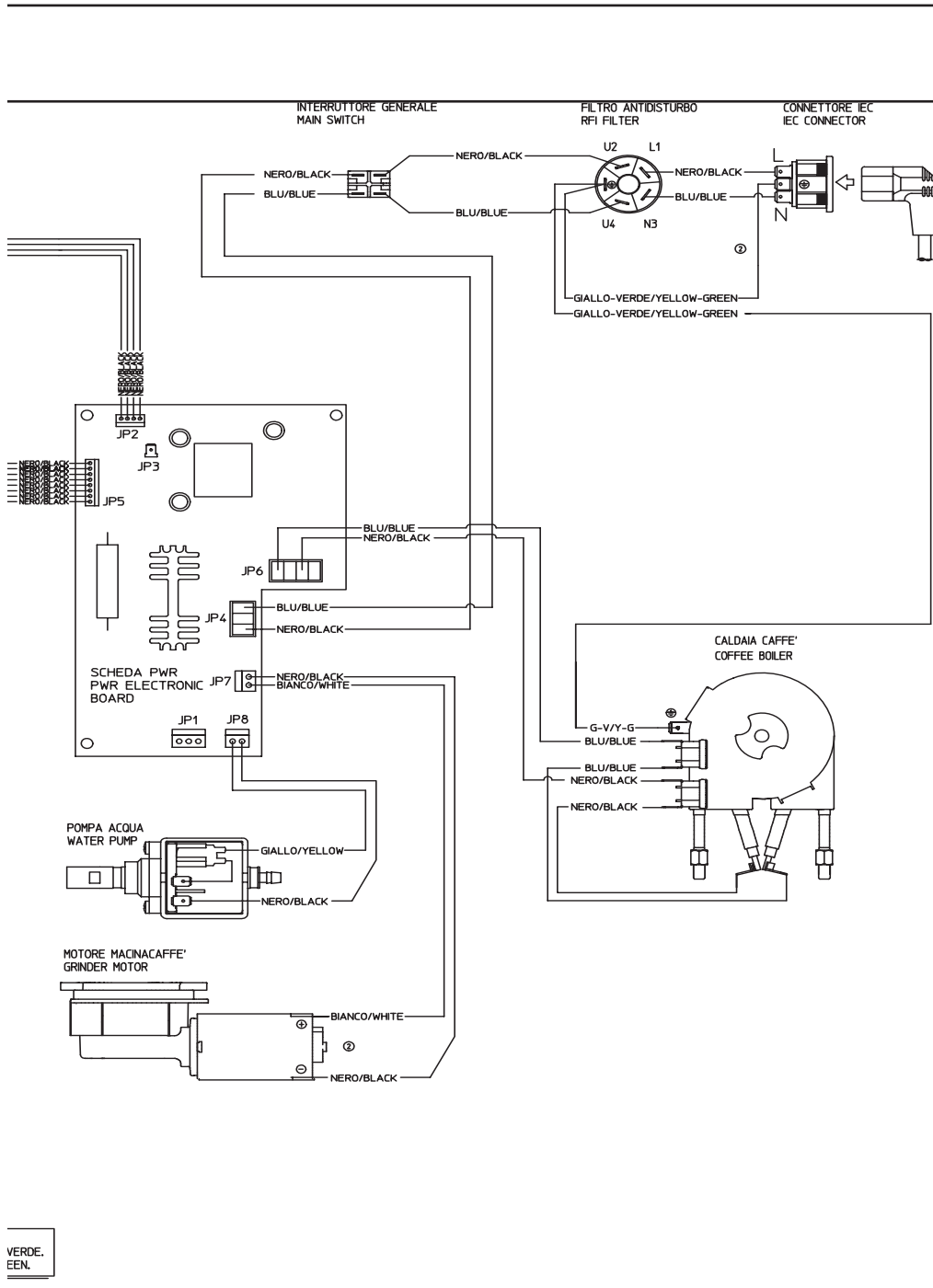

VERDE.
EEN.

Odea Giro

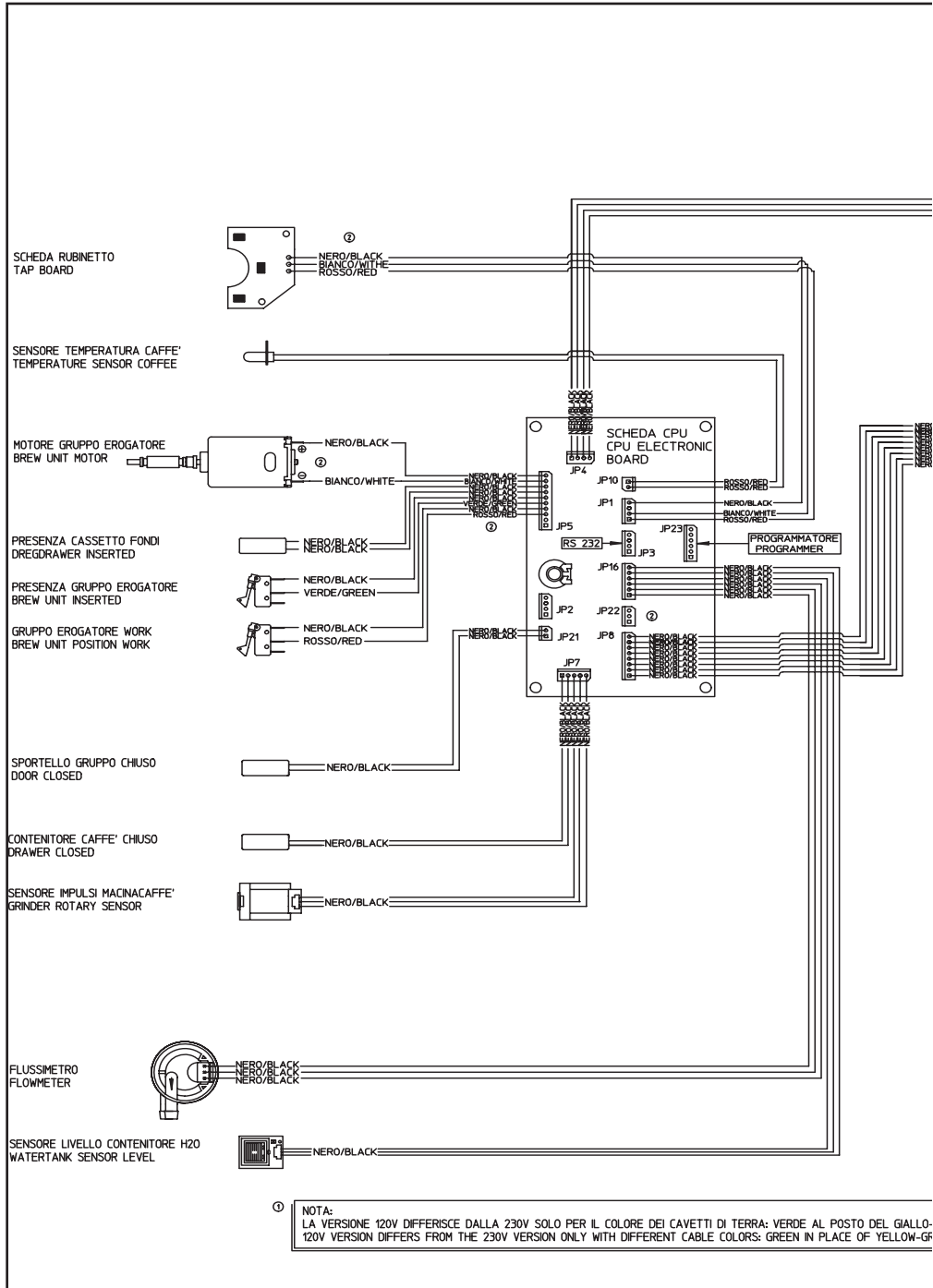

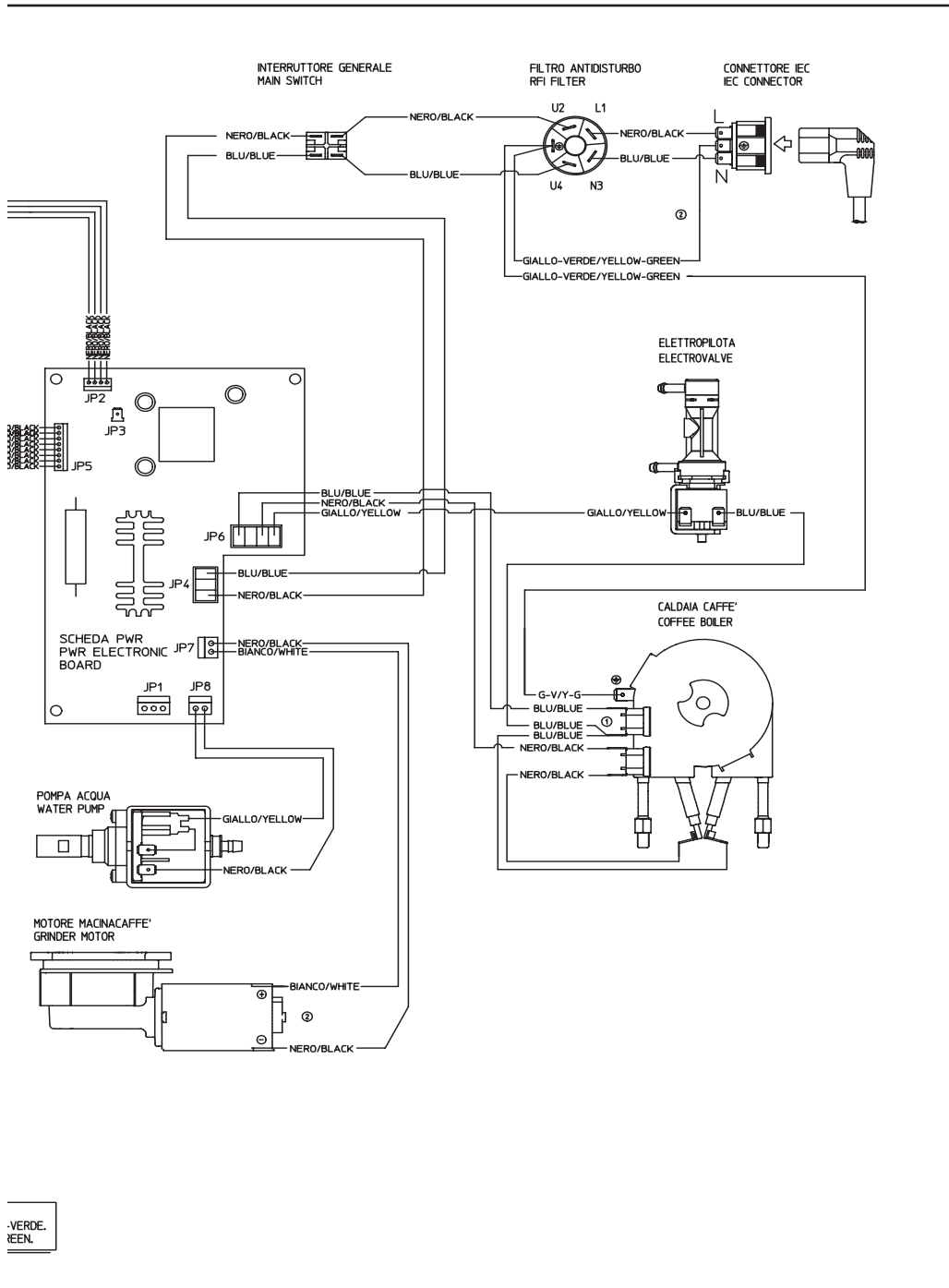

-VERDE.
-REEN.

Talea Giro Plus

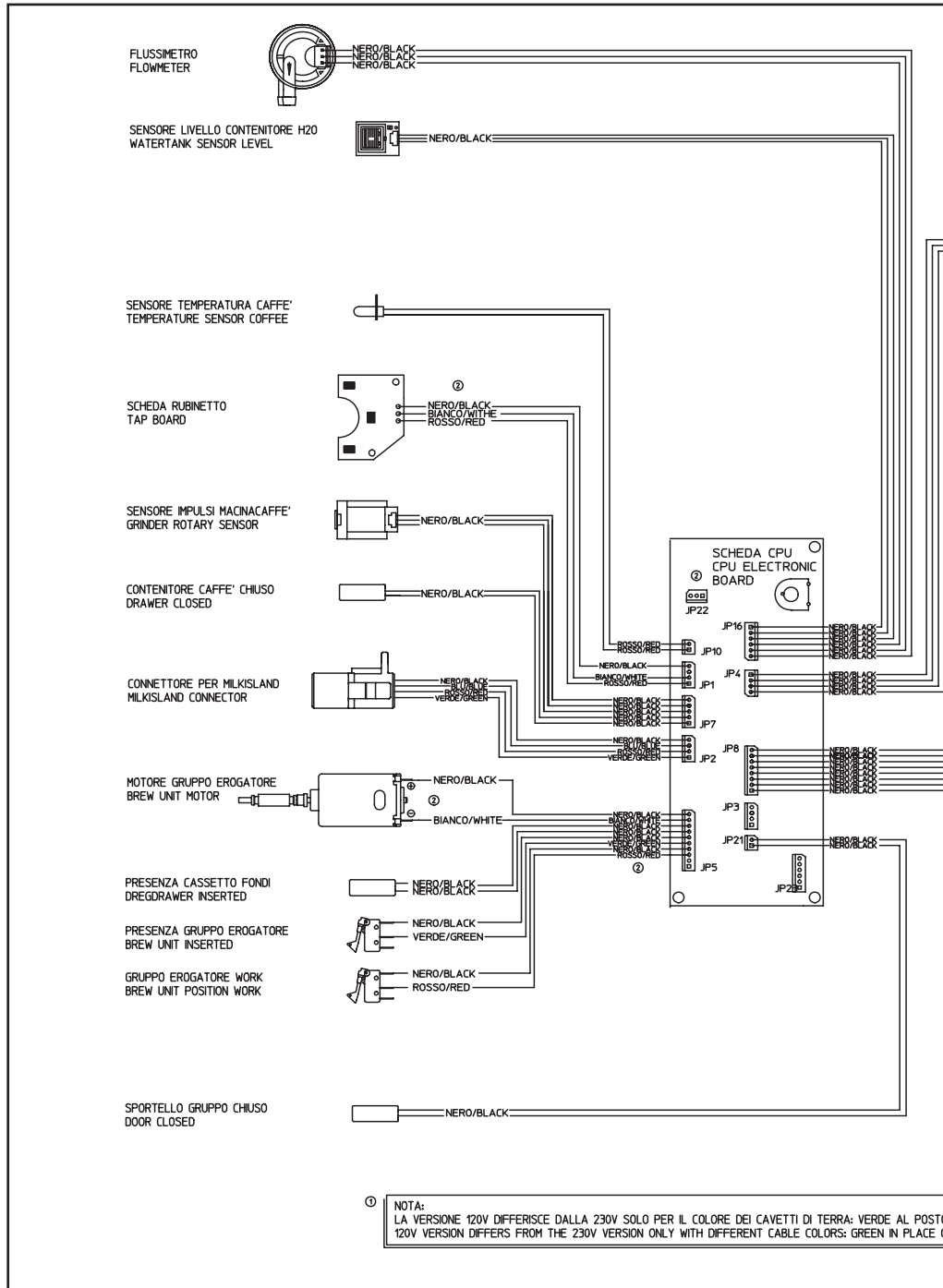

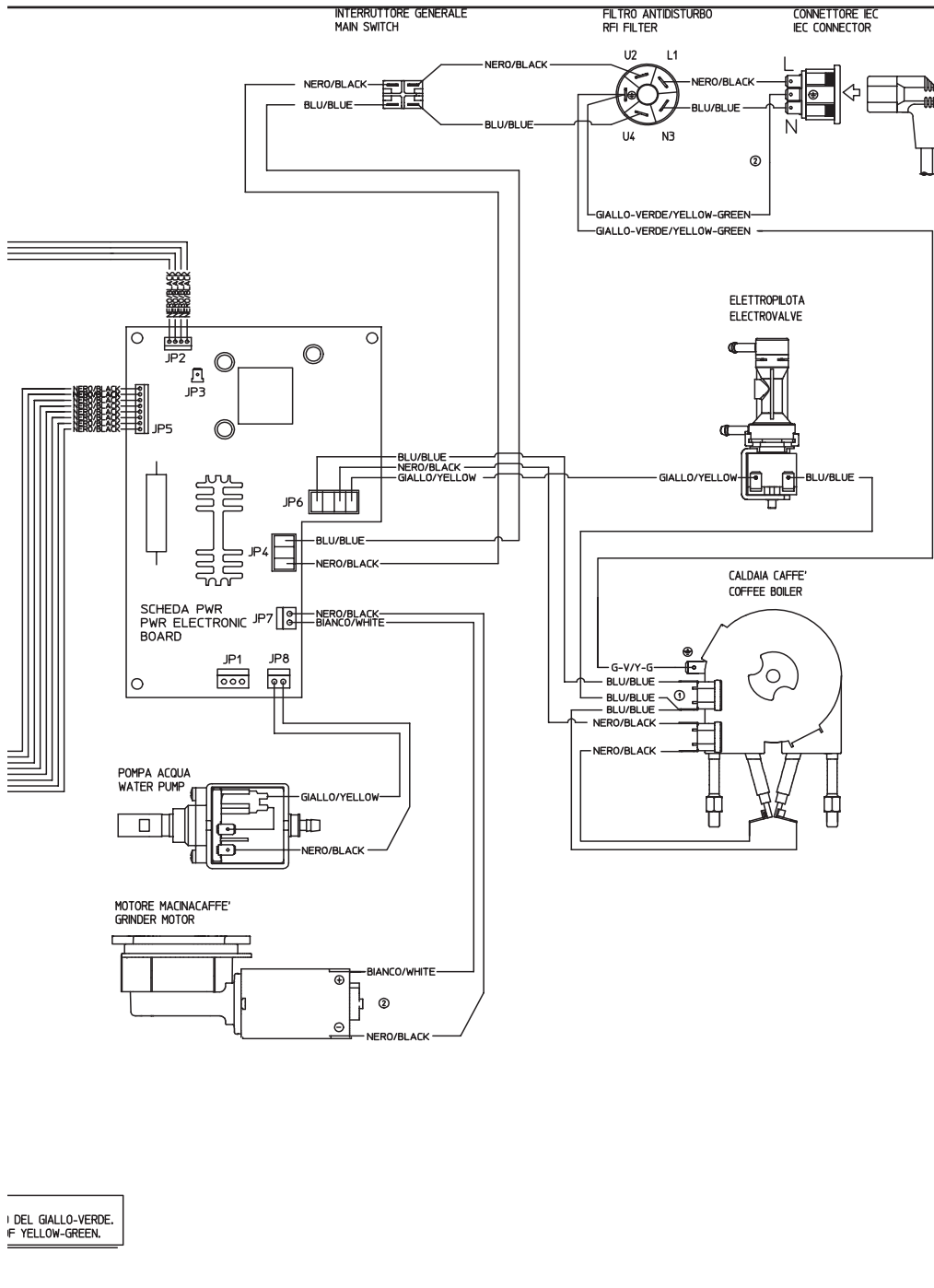

Talea Ring

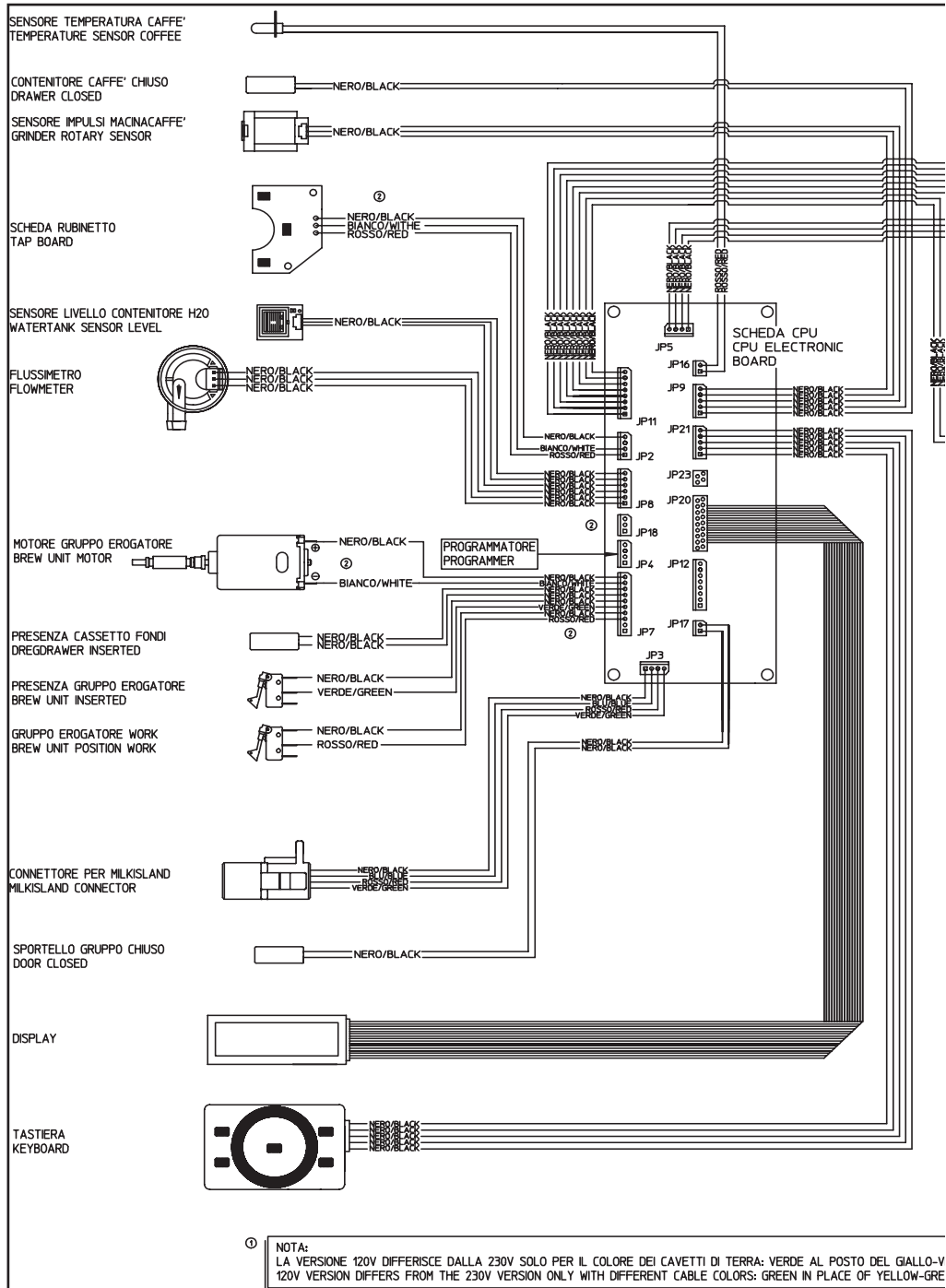

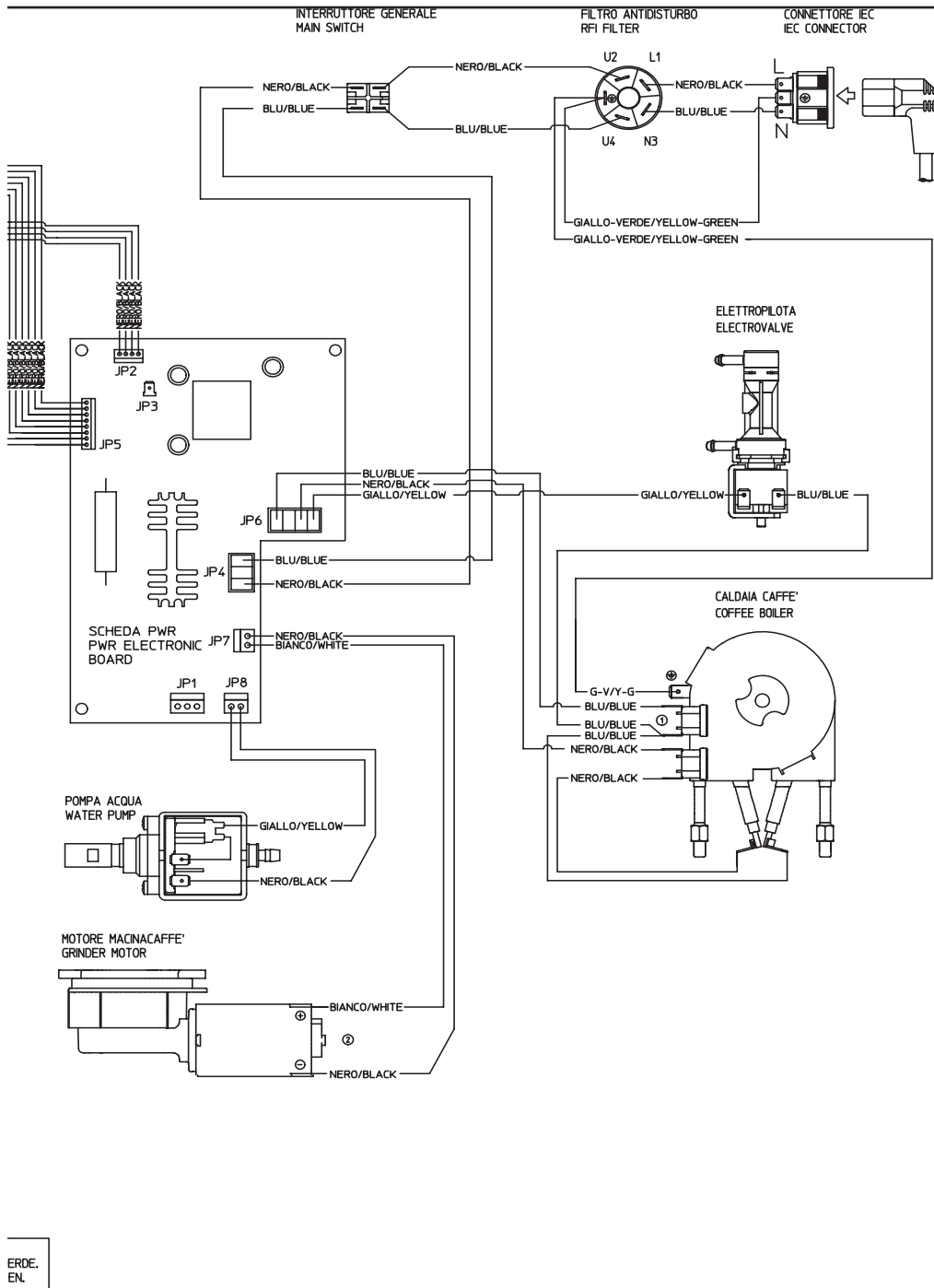

ERDE.
EN.

Talea Ring plus

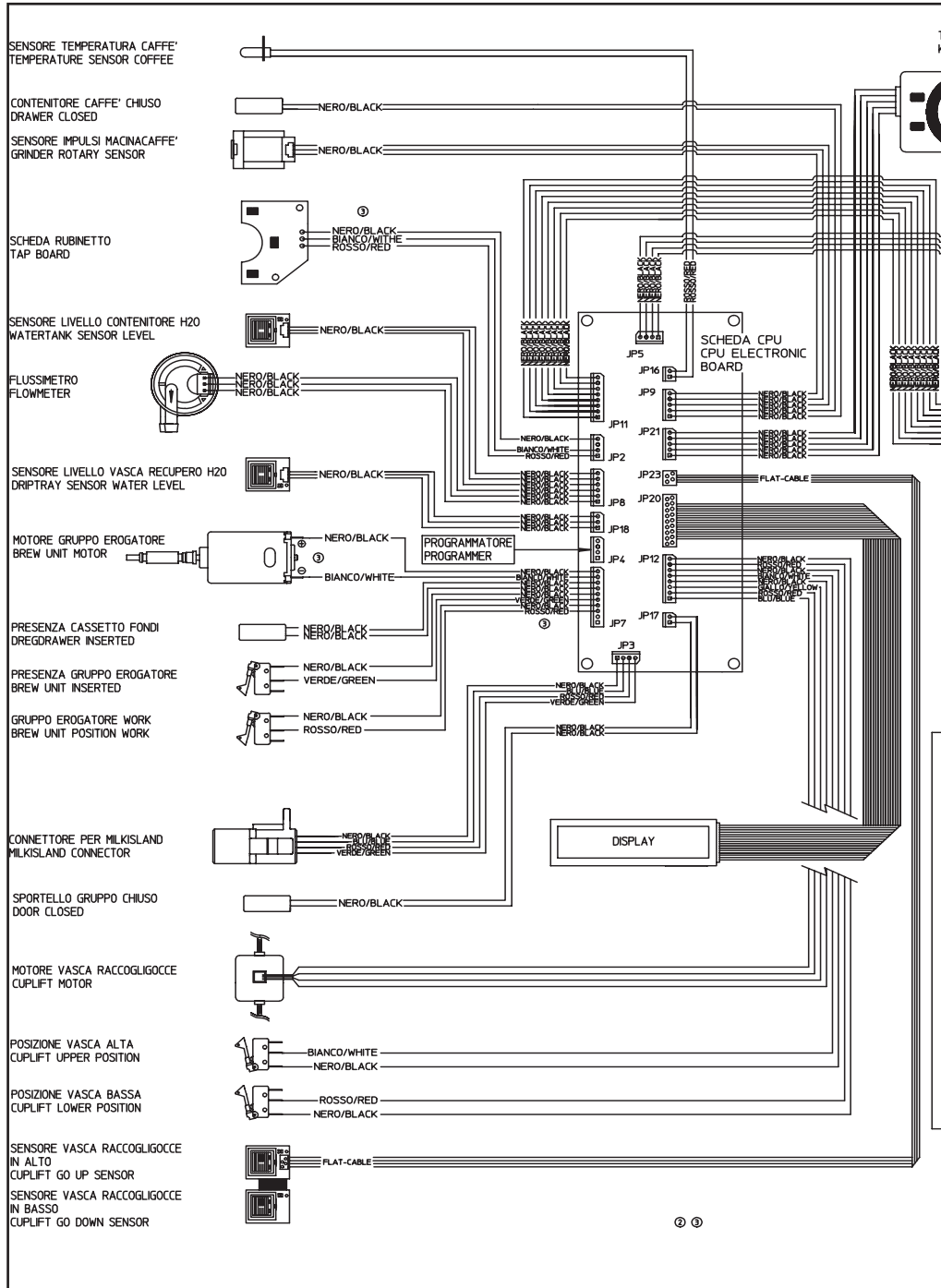

ASTERA
EYBOARD



INTERRUTTORE GENERALE
MAIN SWITCH

FILTRO ANTIDISTURBO
RFI FILTER

CONNETTORE IEC
IEC CONNECTOR

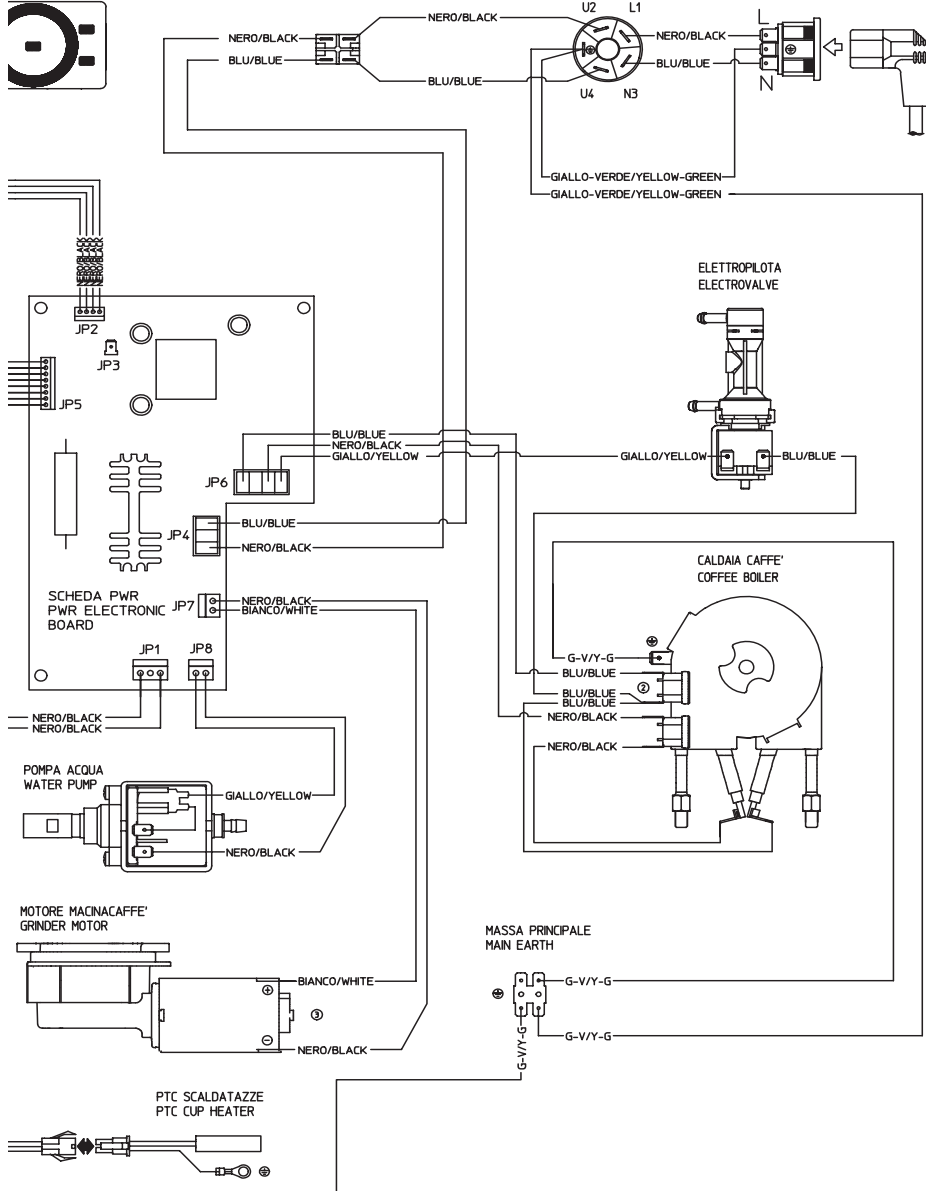

Talea Touch Plus

