

Service
Service
Service



Philips Consumer Lifestyle

Service Manual

PRODUCT INFORMATION

Features

- Colour: Red
- Powerglide soleplate coating
- Pointed tip soleplate
- Steam output: 35 g/min
- Steam boost: 100 g/min
- Steam level control: 3 settings
- Drip stop system
- Spray feature
- Tank capacity: 270 ml
- Cord length: 2 m
- 360 degrees ball swivel
- Filling door
- Double active calc clean feature
- Vertical steam: 100 g/min
- Rubber bumper

Safety Information

- This product meets the requirements regarding interference suppression on radio and TV.
- After the product has been repaired, it should function properly and has to meet the safety requirements and legal regulations as officially laid down at this moment.

TECHNICAL INFORMATION

Voltage	: 220 - 240 V
Frequency	: 50 - 60 Hz
Power	: 1830 - 2200 W
Dimension (F-box)	: 328 mm x 129 mm x 163 mm (Width x Depth x Height)
Product net weight	: 1.21 kg

Water Advice

In case you live in an area with hard water (e.g. water hardness more than 8 dGH), it is recommended to use a mixture of 50 % tap water and 50 % demineralized water.

Powerglide Soleplate

Silver solgel coating for more robust scratch resistance, smooth gliding & easy to clean.

Pointed Tip

This feature allows soleplate to reach tricky area.

Steam Boost

The steam boost helps to remove stubborn wrinkles.

Drip Stop

The water tank bottom has a valve that is controlled by a bimetal disc on the soleplate. Water is only released into steam chamber via the tank valve when the soleplate temperature is high enough. When the soleplate temperature is too low, the tank valve is closed. This prevents water from dripping onto the garment.

Double Active Calc Clean Function

Protects the iron from scale build-up via anti-calc tablets within the water tank & the calc clean function.

Vertical Steam

This features a steam boost in vertical position to remove wrinkles in hanging garments.

BACKPLATE 19

CORDSET 22

BALL SWIVEL 20

- Remove screw A
- Disassemble **BACKPLATE 19**
- Disconnect **3x quick-connectors of CORDSET 22**
- Disassemble **CORDSET 22**

FILLING DOOR ASSY 18

INLAY PRINTED 17

SOS KNOB 15

SPRAY KNOB 16

SPRAY PUMP 9

SOS PUMP 10

LAMP ASSY 5

- Disassemble **FILLING DOOR ASSY 18**
- Remove screw B
- Release rear catch of **INLAY PRINTED 17**
- Disassemble **INLAY PRINTED 17**
- Disconnect **2x quick-connectors of LAMP ASSY 5**
- Disassemble **LAMP ASSY 5**

THERMOSTAT DIAL PRINTED 21

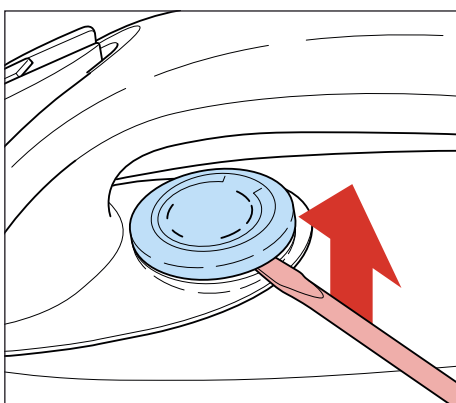

WATER TANK ASSY 7

COVER 3

INSULATION SHEET 23

DOSING SEAL 13

SOS SEAL 14

SOLEPLATE MOUNTED ASSY 1

- Disassemble **THERMOSTAT DIAL PRINTED 21**
- Remove screws C (3x)
- Disassemble **WATER TANK ASSY 7**
- Remove screws D (3x)
- Disassemble **COVER 3**

Note for re-assembly:

Please ensure that INSULATION SHEET 23 is put in place during re-assembly.

This metal part acts as a heat sink to prevent softening of COVER 3 plastics at the screw location D1.

- Due to the high wattage of the iron, only the specified cord set must be used.
- Should damage be observed on the **CORDSET 22**, it must be replaced.
Continued usage is not allowed.
- After the product has been repaired, it should function properly and has to meet the safety requirements & legal regulations as laid down & officially established at this moment.
- The following tests are common checks that are conducted on a repaired product before it is returned to the consumer.

1. Soleplate temperature

Check that soleplate temperature is within IEC requirement.

Measure the temperature of the soleplate after the iron has reached steady state i.e connected to the mains for at least 15 minutes. The table below shows the temperature requirement.

Marking	Soleplate temperature (Deg C)			Material, for example
	Minimum	Maximum	Nominal + Tolerance	
• (1 dot)	70	120	95 ± 25	Acetate, elastane, polyamide, polypropylene
•• (2 dots)	100	160	130 ± 30	Cupro, polyester, silk, triacetate, viscose, wool
••• (3 dots)	140	210	175 ± 35	Cotton, linen

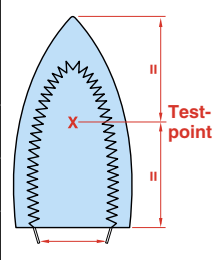

2. Leakage current

Check that leakage current is within IEC requirement.

Measure leakage current between LIVE/NEUTRAL & EARTH.

IEC requirement is that at 230 V supply, the EARTH leakage current must be less than 0.75 mA.

3. Water leakage / Functionality

Check that there is no water leakage from any part of the product during operation.

Check that the functionality of the product (product dependent) eg. steaming, variable steam, SOS, ASO etc is working properly.

4. Loose part

Check that there are no loose parts eg. extra screw in the product that can cause short-circuit or product malfunction.

Pos	Service code	Description
1	4239 021 52820	Soleplate mounted assy 230 V / 2000 W
2	4239 015 70150	Ryton ring
3	4239 026 34230	Cover molded
4	4239 026 13220	Thermostat bush
5	4239 021 50160	Lamp assy
6	4239 015 55800	Tank top seal
7	4239 021 76502	Water tank assy - GC2840
13	4239 015 58300	Dosing seal
14	4239 015 58310	SOS seal
15	4239 026 43322	SOS knob
16	4239 026 43331	Spray knob
17	4239 021 50400	Inlay printed
18	4239 021 51910	Filling door assy
19	4239 026 34620	Backplate Soft Touch
20	4239 026 34650	Ball swivel - Snow white
21	4239 021 53570	Thermostat dial printed - Eng
22	4239 000 08850	Cord set EU
23	4239 010 10290	Insulation sheet
24	4239 026 34630	Steam slider

