

Service
Service
Service



Philips Consumer Lifestyle

Service Manual

Product information

Fast & powerful crease removal

- Soleplate: Non-stick
- Vertical steam
- Steam pressure: 4 bar
- Power: 2400 W
- Continuous steam output: 90 g/min

Easy to use

- Water tank capacity: 1200 ml
- Filling and emptying water: Extra large filling hole
- Refill any time
- Heat-up time: 2 min
- Hose storage: Hose storage compartment
- Cord freedom (swivel): 180 degree cord freedom
- Hose length: 1.6 m
- Power cord length: 1.8 m

Calc management

- Suitable for tap water
- Calc clean solution: Smart Calc Clean
- Calc clean reminder
- Filtered water recommended

Safety Information

- This product meets the requirements regarding interference suppression on radio and TV.
- After the product has been repaired, it should function properly and has to meet the safety requirements and legal regulations as officially laid down at this moment.

Technical information

- Weight of iron : 1.2 kg
- Weight of iron + base : 2.6 kg
- Product dimensions : 19.8 x 21.7 x 34.6 cm
- Packaging dimensions : 26.4 x 30.3 x 40.4 cm
- Voltage : 220 - 240 V
- Frequency : 50 - 60 Hz
- Power : 2400 W

BUTTON 27
TOP COVER 20
CORD BUSHING 21
CONTROL & POWER PCBA 1, 23
STEAM KNOB 4
DIAL KNOB 19
CORD CLAMP 18
HOUSING 5
POTENTIOMETER BOX 17
STEAM TUBE CONNECTOR 8

- Remove **Screw A1, A2**
- Remove **BUTTON 27**
- Remove **Screw B1**
- Remove **TOP COVER 20**
- Remove **Screw C1**
- Remove **CORD BUSHING 21**
- Remove **CONTROL & POWER PCBA 1,23**

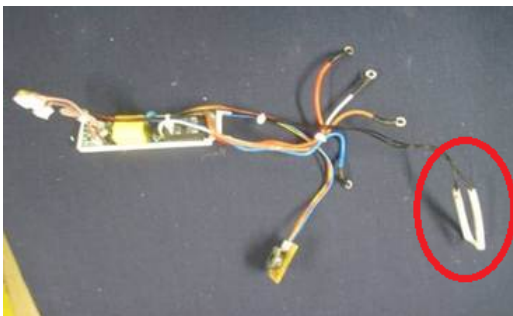

Fig 1: Thermistor is part of the Power PBCA Asm

- Remove **STEAM KNOB 4**
- Remove **Screw D1**
- Remove **DIAL KNOB 19**
- Remove **Screw E1, E2**
- Remove **CORD CLAMP 18**
- Remove **HOUSING 5**
- Remove **Screw F1, F2**
- Remove **POTENTIOMETER BOX 17**
- Remove **Screw G1, G2, G3**
- Remove **STEAM TUBE CONNECTOR 8**

WIRE CONNECTOR 29
CONNECTION WIRE ASM 28
BASE 9
SOLEPLATE ASSY 11

- Remove **Screw A1, A2**
- Remove **BUTTON 27**
- Remove **Screw B1**
- Remove **TOP COVER 20**
- Remove **Screw C1**
- Remove **CORD BUSHING 21**
- Remove **CONTROL & POWER PCBA 1,23**
- Remove **STEAM KNOB 4**
- Remove **Screw D1**
- Remove **DIAL KNOB 19**
- Remove **Screw E1, E2**
- Remove **CORD CLAMP 18**
- Remove **HOUSING 5**
- Remove **Screw F1, F2**
- Remove **POTENTIOMETER BOX 17**
- Remove **Screw G1, G2, G3**
- Remove **STEAM TUBE CONNECTOR 8**
- Remove **Screw H1, H2, H3, H4**
- Remove **WIRE CONNECTOR 29**
- Remove **CONNECTION WIRE ASM 28**
- Remove **BASE 9**
- Remove **SOLEPLATE ASSY 11**

SCREW CAP 57
SILICON CUSHION 56
INSULATION BASE 55
UNIT BASE COVER 51
BOTTOM FOOT 40
WATER TANK ASM 36
UNIT BASE BODY 43

- Remove **SCREW CAP 57**
- Remove **Screws A1, A2**
- Remove **SILICON CUSHION 56**
- Remove **INSULATION BASE 55**
- Remove **Screws C1, C2, C3, C4, C5, C6, C7**
- Remove **UNIT BASE COVER 51**
- Remove **BOTTOM FOOT 40**
- Remove **Screws D1, D2, D3, D4, D5, D6, D7**
- Remove **WATER TANK ASM 36**
- Remove **UNIT BASE BODY 43**

PUMP BRACKET 41, 44
PUMP ASSY 42
CORD CLAMP 45
CORD BOX COVER 50
TERMINAL BLOCK 46
SWITCH BRACKET & ROCKER SWITCH 47
POWER CORD ASM 52

- Remove **SCREW CAP 57**
- Remove **Screws A1, A2**
- Remove **SILICON CUSHION 56**
- Remove **INSULATION BASE 55**
- Remove **Screws C1, C2, C3, C4, C5, C6, C7**
- Remove **UNIT BASE COVER 51**
- Remove **BOTTOM FOOT 40**
- Remove **Screws D1, D2, D3, D4, D5, D6, D7**
- Remove **WATER TANK ASM 36**
- Remove **UNIT BASE BODY 43**
- Remove **Screw E1, E2**
- Remove **PUMP BRACKETS 41, 44**
- Remove **PUMP ASSY 42**
- Remove **Screw F1, F2, F3, F4**
- Remove **CORD CLAMP 45**
- Remove **Screw G1**
- Remove **CORD BOX COVER 50**
- Remove **Screw H1**
- Remove **TERMINAL BLOCK 46**
- Remove **Screw I1, I2**
- Remove **SWITCH BRACKET & ROCKER SWITCH 47**
- Remove **POWER CORD ASM 52**

Pos	Service code	Description
1	9965 100 70233	Control PCB assy
2	9965 100 70251	Control PCB box
3	9965 100 70211	Lamp cover
4	9965 100 70201	Steam knob
5	9965 100 70241	Housing
6	9965 100 70238	Knob cylinder
7	9965 100 70215	Knob spring
8	9965 100 70223	Steam tube connector
9	9965 100 70218	Base
10	9965 100 70202	Thermal insulation pad
11	9965 100 70249	Soleplate assy
12	9965 100 70198	Silicon fiber tube
13	9965 100 70224	Throat clamp
14	9965 100 70246	Bend connector
15	9965 100 70203	Throat clip
16	9965 100 70237	Seal ring 1
17	9965 100 70227	Potentiometer box
18	9965 100 70247	Cord clamp
19	9965 100 70242	Dial knob
20	9965 100 70199	Top cover
21	9965 100 70214	Cord bushing
22	9965 100 70208	Power PCB box
23	9965 100 70232	Power PCB asm
24	9965 100 70225	Silicon pad
25	9965 100 70239	Spring 4
26	9965 100 70194	Switch hole cover
27	9965 100 70197	Button
28	9965 100 70207	Connection wire asm
29	9965 100 70228	Wire connector
30	9965 100 70231	Iron base support

Pos	Service code	Description
31	N/A	Release button
32	N/A	2 Spring 2
33	N/A	Lock fastener
34	N/A	Location fastener
35	N/A	Bolt base
36	9965 100 70236	Water tank asm
37	9965 100 70226	Seal ring
38	9965 100 70243	Water tube connector
39	9965 100 70196	Silicon tube
40	9965 100 70206	Bottom foot
41	9965 100 70216	2 Pump bracket 2
42	9965 100 70245	Pump assy
43	9965 100 70234	Unit base body
44	9965 100 70248	1 Pump bracket 2
45	9965 100 70205	Cord clamp
46	9965 100 70222	Terminal block
47	9965 100 70217	Switch bracket & Rocker switch
48	9965 100 70195	Safety valve asm
49	9965 100 70219	Silicon tube
50	9965 100 70213	Cord box cover
51	9965 100 70221	Unit base cover
52	9965 100 70209	Power cord asm - Swiss
52	9965 100 70212	Power cord asm - VDE
52	9965 100 70229	Power cord asm - BS
55	9965 100 70244	Insulation base
56	9965 100 70204	Silicon cushion 1
57	9965 100 70235	Screw cap
58	N/A	1 Spring 1
59	9965 100 71433	Calc clean container & sticker

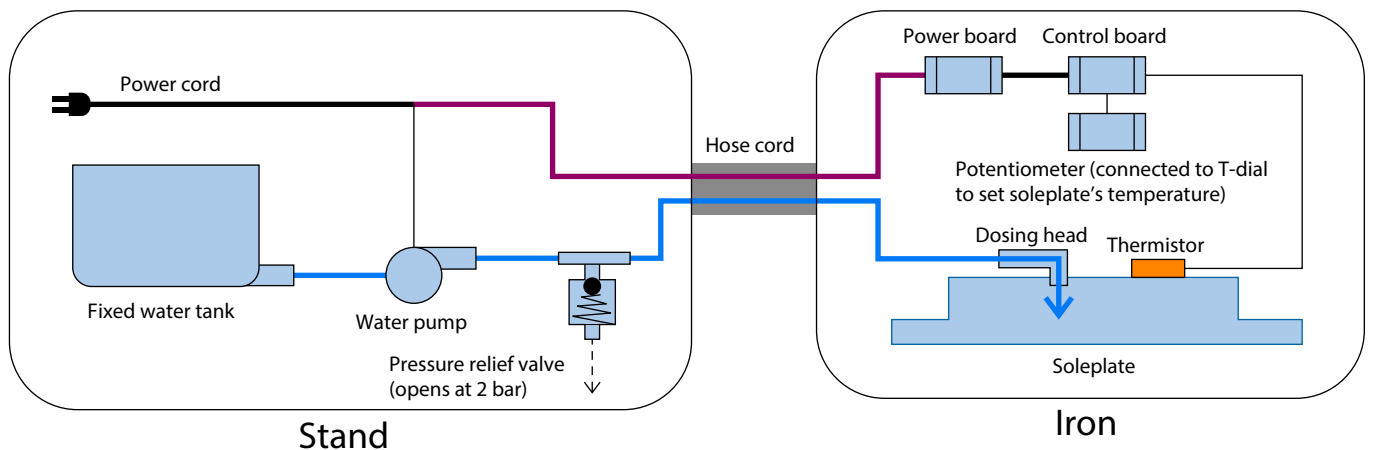

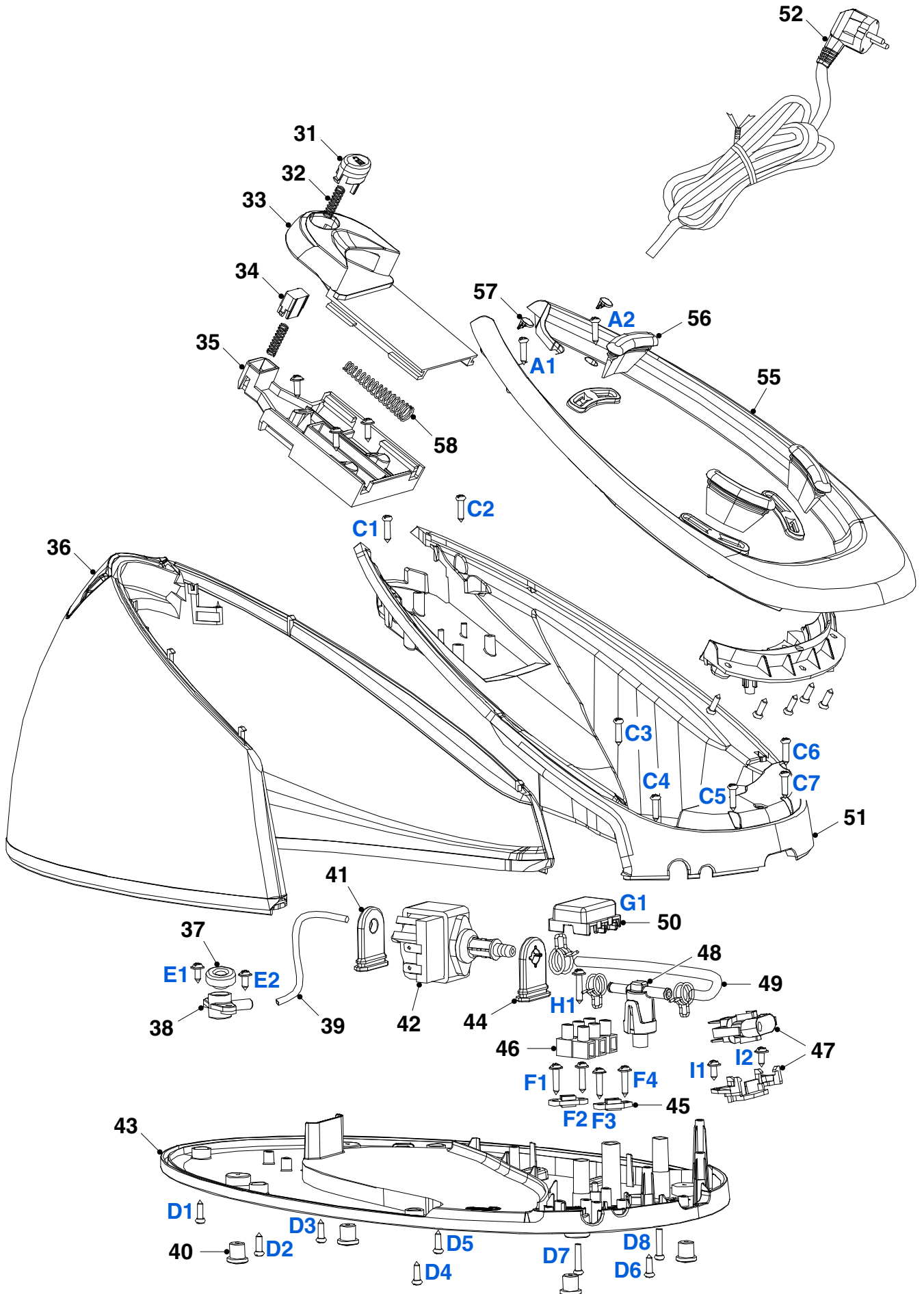

- Due to the high wattage of the iron, only the specified cord set must be used.
- Should damage be observed on the **POWER CORD 52**, it must be replaced.
- Continued usage is not allowed.
- If **UNIT BASE BODY 43** is provided without type plate information eg. Type number, voltage etc. When replacing the cover, engrave the type number & voltage on the type plate with a sharp object.
- After the product has been repaired, it should function properly and has to meet the safety requirements & legal regulation as laid down & officially established at this moment.
- The following tests are common checks that are conducted on a repaired product before it is returned to the consumer.

1. Soleplate temperature

Check the soleplate temperature is within IEC requirement.

Soleplate temperature (Deg C)		Materials, for example	
Minimum	Maximum		
120	143	All fabric types	

2. Leakage current

Check that leakage current is within IEC requirement.

Measure leakage current between LIVE/NEUTRAL & EARTH.

IEC requirement is that at 230 V supply, the EARTH leakage current must be less than 0.75 mA.

3. Water leakage / Functionality

Check that there is no water leakage from any part of product during operation.

Check that the functionality of the product (product dependent) eg. Steaming, steam trigger, variable steam, SOS, PCBA etc is working properly.

4. Loose part

Check that there are no loose parts eg. Extra screws in the product that can cause short-circuit or product malfunctions.

5. Fuse open circuit

When replacing fuse, to also service the water tubes which is probably choked with calc.

6. PCBAs ESD control

All failed PCBAs including to be packed with ESD bags for shipment.

7. Screws

Screws should be the defined screws in terms of length and material used.

The torque of the thermistor-soleplate screw is 9-12kg f.cm.