



Philips Consumer Lifestyle

ServiceManual

PRODUCT INFORMATION

Fast & powerful crease removal

- Soleplate: T-IonicGlide
- OptimalTemp
- Continuous steam output: 120 g/min
- Steam boost: 350 g
- Vertical steam
- Steam pressure: Up to 6.5 bar
- Steam tip
- Power: 2400 W

Easy to use

- Water tank capacity: 1500 ml
- Filling and emptying water: Detachable water tank
Extra large opening door
- Refill any time
- Heat-up time: 2 min
- Hose storage: Hose storage compartment
- Cord storage: Cord storage compartment
- Power cord length: 1.8 m
- Cord freedom (swivel): 180 degree cord freedom
- Hose length: 1.7 m
- Safe for all fabrics: Even for delicates like silks

Calc management

- Suitable for tap water
- Calc clean solution: Easy De-calc
- Calc clean reminder

EMF & Service Information

- This product meets the requirements regarding interference suppression on radio & TV.
- After the product has been repaired, it should function properly & has to meet the safety requirements as officially laid down at this moment.

TECHNICAL INFORMATION

Voltage	: 220 - 240 V
Frequency	: 50 - 60 Hz
Power - Iron	: 800 W at 230 V
- Boiler	: 1370 W at 230 V
Dimension (F-box)	: 491 mm x 305 mm x 335 mm (Depth x Width x Height)
Weight	: Weight of iron: 1.2 kg Weight of iron + base: 5 kg

Optimal Temp technology

- Delivers always perfect combination of steam and temperature
- 100% easy to use, no adjustment required
- 100% safe on all ironable garments
- 100% effective on all fabrics, no other iron is faster
- Tested and approved by independent textile experts

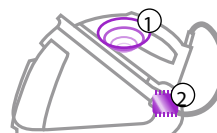

Always the perfect setting thanks to:
1 - Cylonic steam chamber
2 - Advanced Smart control processor

Easy De-calc

Easy De-calc cap allows hassle free & effective scale removal to extend the life of the steam generator.

BACKPLATE ASSY 16

SOS KNOB 13

INLAY MOLDED 17

MICRO-SWITCH ASSY 12

HOSE CORD MOUNTED
ASSY SOS 15

HOUSING & LENS
ASSY PRINTED 9

LIGHT GUIDE ASSY 10

COVER MOLDED SOS 8

DEVIATOR ASSY 3

SOLEPLATE MOUNTED
ASSY 1

- Remove Screw A
- Disassemble BACKPLATE SCREW PLATE 21
- Remove Screws B1, B2
- Disassemble BACKPLATE ASSY 16
- Remove Screws C1, C2
- Remove Cord clamp
- Disassemble SOS KNOB COVER 18

Tip for disassembling SOS KNOB COVER 18 :
Carefully insert a sharp object into the gap at the side & slowly lift up the part

- Disassemble SOS KNOB 13
- Remove Screw D
- Disassemble INLAY MOLDED 17
- Remove Screw E
- Disassemble MICRO-SWITCH ASSY 12
- Remove Screw F
- Disassemble HOUSING & LENS ASSY PRINTED 9
- Remove Screws G1, G2
- Disassemble LIGHT GUIDE ASSY 10
- Remove Screws H1 - H3
- Disassemble COVER MOLDED SOS 8
- Remove Screws J1 - J6
- Disassemble DEVIATOR ASSY 3

Pos	Service code	Description
1	4239 021 82131	Soleplate mounted assy 230 V / 800 W
2	4239 021 61472	Thermistor assy Iron
3	4239 021 61524	Deviator assy
4	4239 015 59151	Braided rubber hose iron
5	4239 010 11991	Hose clip (ID=8.7)
6	4239 010 10281	Hose clip-Braided rubber hose
7	4239 015 70153	Ryton ring
8	4239 026 52531	Cover molded SOS
9	4239 021 82141	Housing & Lens assy printed
10	4239 021 61772	Light Guide assy
11	4239 021 75621	Deco_Plate & top Cover assy printed
12	4239 021 61561	Micro-switch assy
13	4239 021 75641	SOS knob sprayed painted
14	4239 026 42481	SOS lever molded
15	4239 021 75651	Hose cord mounted assy SOS
16	4239 021 75911	Backplate assy
17	4239 026 52591	Inlay molded
18	4239 026 42521	SOS knob cover
19	4239 026 52601	Trigger molded
20	4239 014 54961	Trigger spring
21	4239 026 42551	Backplate screw cap

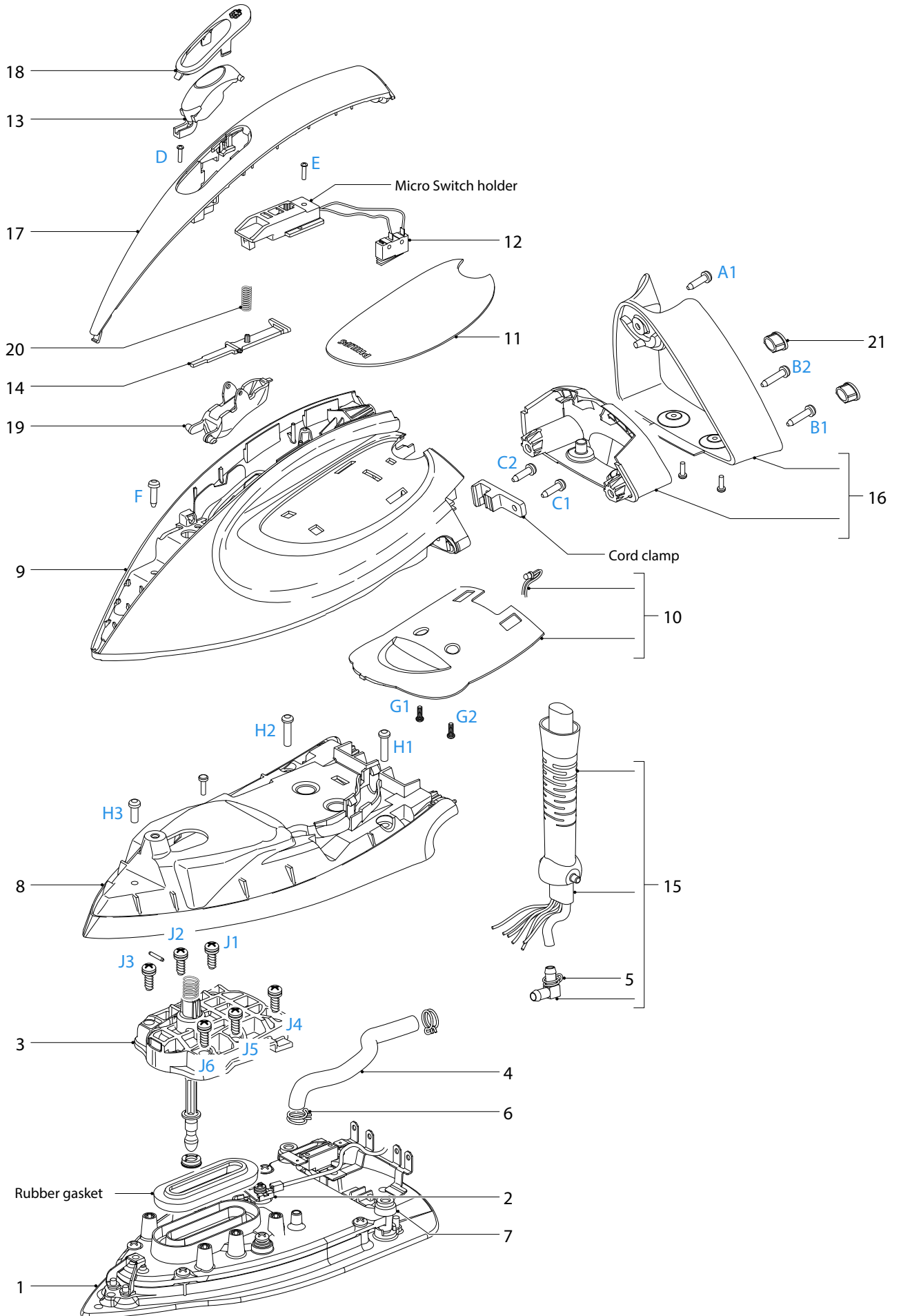

WATER TANK PRINTED
ASSY 58

TRAY MOLDED 53

DISPLAY COVER PRINTED
ASSY 50

STAND TOP MOLDED 45

POWER CORD STORAGE
MOLDED 42

HOSE CORD STORAGE
COMPARTMENT ASSY 43

RINSE CAP ASSY 56

RINSE HOUSING
PRINTED 39

BOILER ASSY 36

BUTTON PANEL ASSY 51

POWER BOARD PCB
ASSY 60





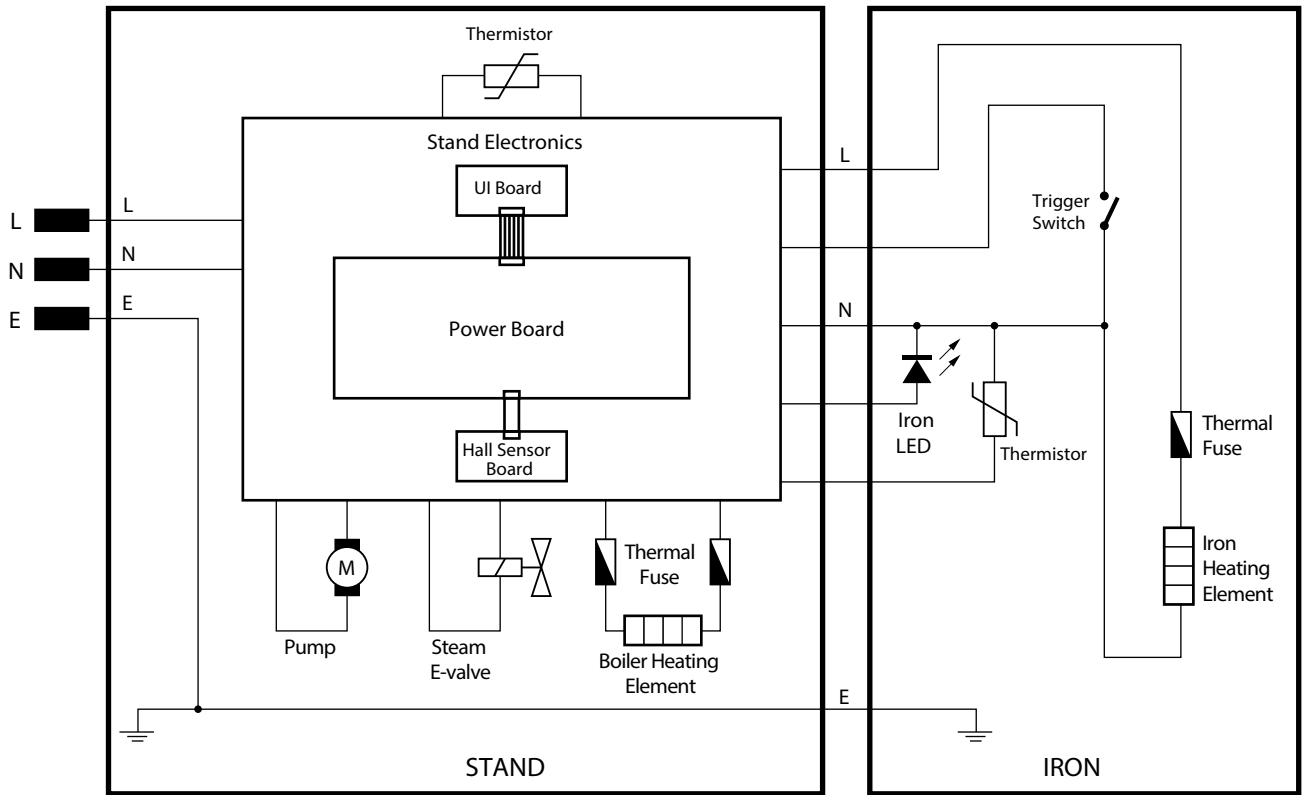

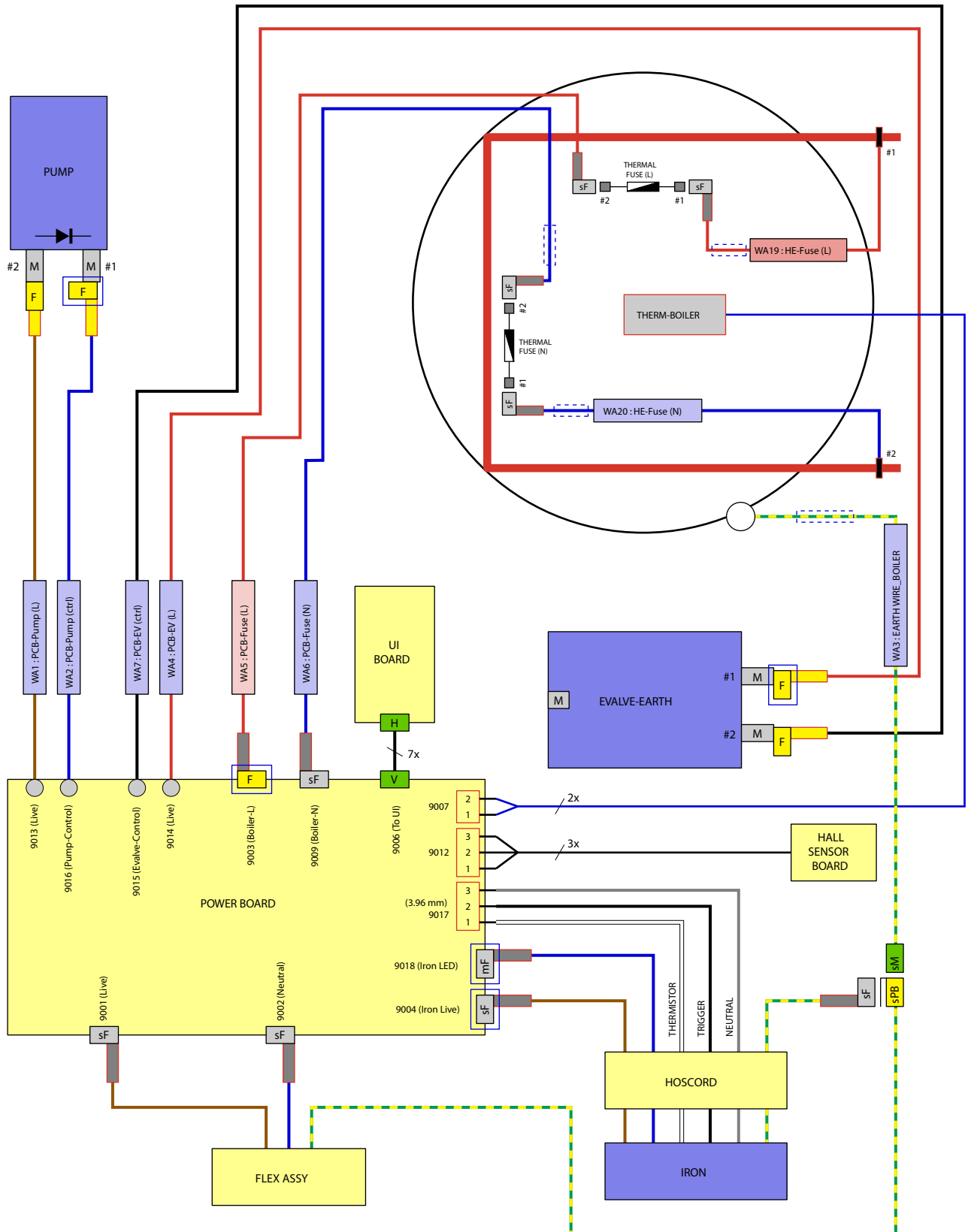
- Remove WATER TANK PRINTED ASSY 58
- Remove TRAY RUBBER CAP 54
- Remove Screws K1, K2
- Disassemble TRAY MOLDED 53
- Remove Screws L1 - L4
- Remove Screw M
- Remove Screws N1 - N4
- Disassemble DISPLAY COVER PRINTED ASSY 50
- Remove Screws P1 - P3
- Disassemble STAND TOP MOLDED 45
- Remove Screws Q1, Q2
- Disassemble POWER CORD STORAGE MOLDED 42
- Disassemble HOSE CORD STORAGE COMPARTMENT
ASSY 43
- Remove RINSE CAP ASSY 56
- Remove Screws R1, R2
- Disassemble RINSE HOUSING PRINTED 39
- Remove Screws S1, S2, S3
- Disassemble BOILER SUPPORT BRACKET MOLDED 41
- Disassemble BOILER ASSY 36
- Remove Screws T1, T2
- Disassemble BUTTON PANEL ASSY 51
- Remove Screw U
- Disassemble POWER BOARD PCB ASSY 60







Pos	Service code	Description
30	4239 021 61591	Stand bottom assy
31	4239 021 61604	Pump assy
32	4239 026 42083	De-air valve
33	4239 015 59201	Braided rubber hose boiler
34	4239 010 10261	Inox clamp
35	4239 026 32181	Spacer Bottom molded
36	4239 021 61612	Boiler assy
37		Electrovalve
38	4239 021 61812	Thermistor assy Boiler
39	4239 021 76222	Rinse Housing printed
40	4239 026 51241	Spacer top molded
41	4239 026 42581	Boiler support bracket molded
42	4239 026 42592	Power cord storage molded
43	4239 021 61621	Hose cord storage compartment assy
44	4239 000 11581	Cord set EU/Korea
45	4239 026 52621	Stand top molded
46	4239 026 52631	Tank Catch molded
47	4239 014 54982	Tank Catch Spring
48	4239 021 75681	Inlet coupling plate welded
49	4239 026 52751	De-air coupling molded
50	4239 021 76611	Display cover printed assy
51	4239 021 75691	Button panel assy
52		Front Bracket assy
53	4239 026 42743	Tray molded
54	4239 015 60231	Tray rubber cap
55	4239 015 60241	Rinse Rubber Bush
56	4239 021 75721	Rinse cap assy
57	4239 015 58201	O ring
58	4239 021 82151	Water tank printed assy
59	4239 021 61723	Hall sensor PCBA assy
60	4239 021 81011	Power Board PCB assy





LEGEND:

-  Female Push-on 4.8 x 0.8 mm L-shape Connector
-  Female Push-on 5.2 x 0.8 mm L-shape Connector
-  Male Tab Terminal 4.8 x 0.8 mm
-  Female Push-on L-shape Connector 6.35 x 0.8 mm
-  Female Push-on Connector 6.35 x 0.8 mm
-  Male Tab Terminal 6.35 x 0.8 mm
-  Piggy Back Push-on Connector 4.8 x 0.8 mm

-  Sleeve - Fiber Glass
-  Insulated Tab - Silicon Rubber
-  Ring Terminal M4.3
-  Splice 6.0 mm
-  Directly soldered on PCB
-  7-pin Board-in Connector 2 mm (horizontal)
-  7-pin Connector 2 mm (vertical)

- Due to the high wattage of the iron, only the specified cord set must be used.
- Should damage be observed on the HOSE CORD MOUNTED ASSY 15 or CORD SET 44 , they must be replaced. Continued usage is not allowed.
- When replacing the MICROSWITCH ASSY 12 , please dress the 2 attached wires such that they are free of tension. Pulling force on the wires may affect the steam triggering.
- To avoid damage to the sealing & components of the BOILER ASSY 36, NEVER clean the boiler assy with vinegar, descaling agent or other corrosive chemicals.
- When replacing ELECTROVALVE 37 or PUMP ASSY 31 , please be reminded to apply loctite at the joints for good sealing.
- After the product has been repaired, it should function properly and has to meet the safety requirements & legal regulations as laid down & officially established at this moment.
- The following tests are common checks that are conducted on a repaired product before it is returned to the consumer.

1. Soleplate temperature

Check that soleplate temperature is within below requirement.

Measure the temperature of the soleplate after the iron has reached steady state i.e connected to the mains for at least 15 minutes.

The table below shows the temperature requirement.

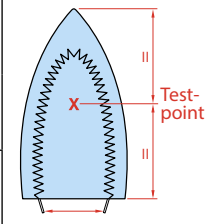
Soleplate temperature (Deg C)		Materials, for example	
Minimum	Maximum		
120	143	All fabric types	

2. Leakage current

Check that leakage current is within IEC requirement.

Measure leakage current between LIVE/NEUTRAL & EARTH.

IEC requirement is that at 230 V supply, the EARTH leakage current must be less than 0.75 mA.

3. Water leakage / Functionality

Check that there is no water leakage from any part of the product during operation.

Check that the functionality of the product (product dependent) eg. steaming, variable steam, SOS, ASO etc is working properly

4. Loose part

Check that there are no loose parts eg. extra screw in the product that can cause short-circuit or product malfunction.

5. Crimping INOX CLAMP 34

When exchanging BOILER ASSY 36 or DE-AIR VALVE 32 or BRAIDED RUBBER HOSE BOILER 33, it is necessary to replace the INOX CLAMP 34. Below instructions ensure that the inox clamp is crimped correctly.



Knipex Crimping tool

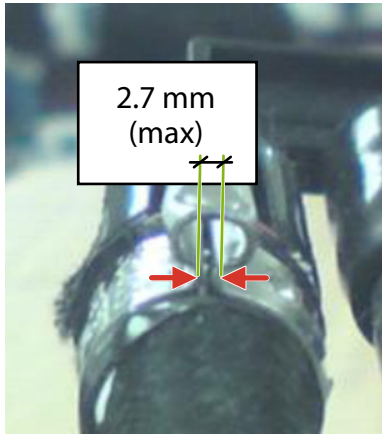

Direct crimp form

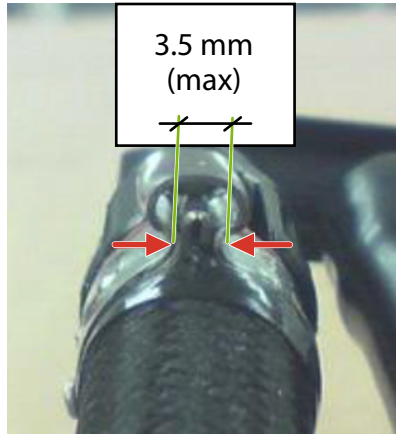

Fold in crimp

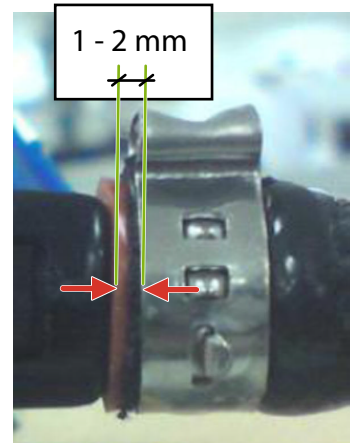

Distance from edge of crimp to rubber hose

CAUTION: When crimping on plastic part like DE-AIR VALVE, avoid over crimping which may lead to plastic part crack.

6. Replacing ELECTROVALVE 37

To prevent damage to the electrovalve during service activity, please observe below precautions during disassembly & reassembly.

Tools required: Torque wrench (set to 6 kgf)



CAUTION #1: The torque wrench engagement is allowed ONLY at the yellow box locations in below picture.

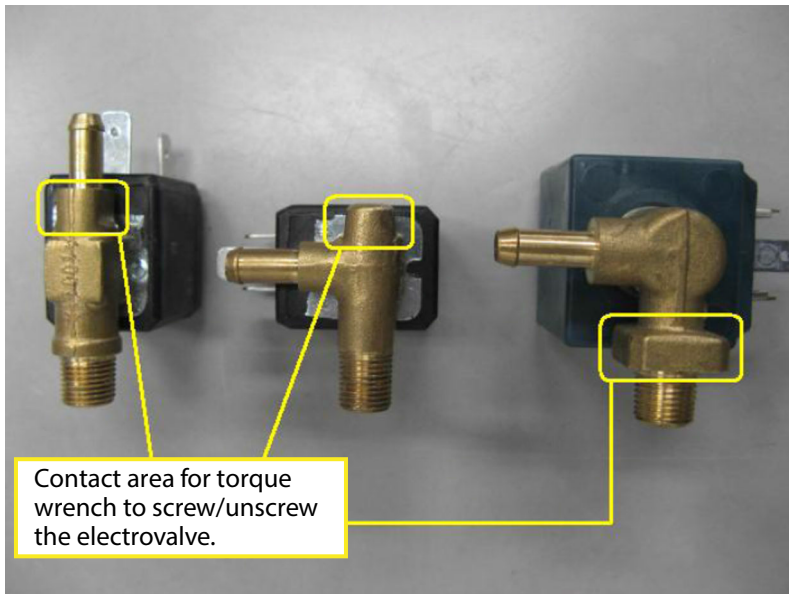

CAUTION #2: Ensure torque wrench jaw does not contact the solenoid body.

