



Philips Consumer Lifestyle



Service Manual

PRODUCT INFORMATION

- This product meets the requirements regarding interference suppression on radio and TV.
- After the product has been repaired, it should function properly and has to meet the safety requirements as officially laid down at this moment.

TECHNICAL INFORMATION

- Voltage : 220 - 240 V
- Frequency : 50 - 60 Hz
- Power consumption : 1450 W
- Standby power consumption : <0,5 W
- Contents water reservoir : 1200 cc
- Colour setting : Beluga
- Sap coding : HD7835/10

	Coffee volume overview		
	 Min cc/mL	 Normal cc/mL	 Max cc/mL
France version	80	100	140
General version	80	122	145

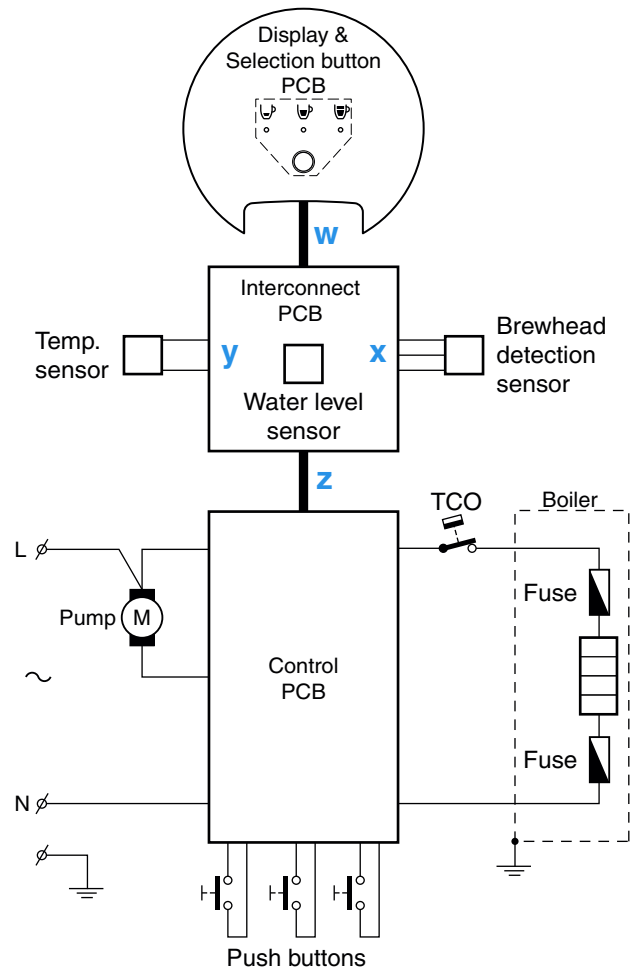

Before you start dismantling!

 For your safety be sure the plug is disconnected from the mains!

The product is designed for easy access to the internal components.

Make sure that all accessories like tank, podholder, drip tray, spout and collector have been removed.

To remove the back cover, follow below steps:

- Remove the two Torx screws (T15) **A** (see exploded view).
- Remove the valve outlet.
- Start at the upper side of the back cover, using a flat head screwdriver to unhook the top of the back cover and gently pull the back cover from the appliance so that a little chink between back cover and brew chamber becomes visible.
- Again use the screwdriver to unhook the two “snap locks” at each side of the back cover, and gently move the screwdriver in the direction of the opposite side of the appliance, in such a way that the lips of the snap locks are bent outwards and unhook.
- If all snap locks are unhooked, it is possible to remove the back cover. Gently pull the back cover upwards to release the bottom part of the back cover from the housing. Please note that the back cover is still connected to the pump.
- For reassembly follow these steps backwards.

To remove the brew chamber lid cover, follow below steps:

- Place a large screwdriver on the positions (see picture 1) and lift the cover over the snap locks on both positions, use appropriate force.

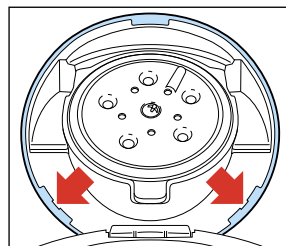

picture 1

- The cover lid can now be lifted up, but stays attached to the brew head by the push rod, to remove the complete cover including lever and push rod squeeze both legs of the push rod strongly together (see picture 2), so that the two pins will unhook out of the hinge position on the brew chamber.

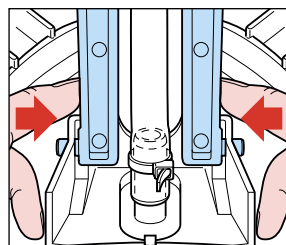

picture 2

- To remove lever from lid cover, take a screwdriver and bend carefully the two lips/ribs in the lid cover outwards and push the lever with force out of the hinge.
- To reassemble, follow steps backwards, without using a screwdriver.

To remove the brew chamber head assy, follow below steps:

- Remove the back cover.
- Place the appliance in front of you in such a way that you are facing the rear side of the appliance.
- First remove the boiler from the snap lock position of the brew chamber.
- To remove the brew chamber, use your both thumbs (see picture 3) and push strongly with a little distortion (rotation) until the brew chamber comes loose (upwards).

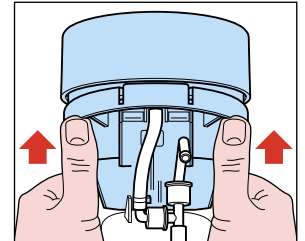

picture 3

- Reassemble follow above steps backwards.

To reach the components placed inside the base (for example exchange the NTC temperature sensor) follow below steps:

- First remove back cover, three-way valve and boiler.
- The brew chamber can be removed by unhooking the two snap locks behind the boiler, pull the brew chamber upwards to remove it from the housing.
- Remove both Torx T15 screws **B** (see exploded view).
- Unhook the two snap locks on the back side of the base with a screwdriver (see base), the housing can now be removed.
- To remove the rest of the housing unlock the last 4 snap locks on the base and gently pull of the front cover.
- To reassemble follow above steps backwards.

To exchange the display assembly in the brew head follow below steps:

- Remove the back cover, and disconnect the hose to the brew head from the three-way valve.
- Dismount the water-protected interconnect-PCB on the left hand side of the appliance.
- Disconnect the electrical cable of the display assy, from the interconnect PCB.
- Open the brew head, use a flat head screw driver on the brew head hinge to disconnect the brew head from brew chamber.
- Place the brew head upside down on a protective cloth (to prevent scratching), use two screwdrivers unhook the lid frame from the lid, both stay connected through the slider. The display assy is now accessible.
- On reassembly pay special attention to the routing of the cables and hoses.

OPTIONAL (accessories)

- No specific issues

Note:

Please note after replacing the boiler the appliance has to be restored to factory default. The filling procedure (cold flush), known from the predecessor Senseo's is no longer available after the flush before first use has been executed. When the "restore to factory default" procedure is not carried out, a new and empty boiler can be switched on, without having the protection of the initial flush procedure, causing the thermal fuses in the heating element to fail.



After a boiler re placement or drained system, carry out the "Restore boiler_empty_flag to factory default" procedure! Then the initial flush procedure can be carried out.

Descaling

Descaling is an important element in Senseo maintenance. It should be done at least once every 3 months, up to 6 times a Year! This will prolong the life of your appliance and will guarantee optimal brewing results for a long time.

Use the correct descaling agent. Only citric acid-based descalers are suitable for descaling the SENSEO® machine. This type of descaler descales the appliance without damaging it. For the correct amount, see under 'Descaling procedure' below.

Each descaling mixture can be used only once. After use, the descaling mixture is no longer active. We advise you to use the special SENSEO® Descaler (HD7006).

Read the instructions on the package of the descaling agent. Never use a descaling agent based on mineral acids such as sulphuric acid, hydrochloric acid, sulphamic acid and acetic acid (e.g. vinegar). These descaling agents may damage your SENSEO® coffee machine.

Follow the steps in the section headed "Descal the appliance" see DFU (Direction for Use manual).

Volume adjustment

The PCB circuit board makes it possible to adjust the volume output by means of pushing the one-cup and two-cup user controls.

How to adjust the volume output:

1. Make sure the boiler is filled properly, otherwise perform fill procedure see DFU for instructions.
2. Switch appliance on and wait until the unit is ready to brew.
3. Make sure that normal cup volume has been selected with the volume selection knob (2 stripes on display, see picture) 
4. Make sure a pod holder is placed, but without a Coffee POD. (Only adjusting with plain water)
5. Place a cup on the drip tray cover and push the one-cup button.
6. When the appliance has finished it is stabilized to perform the volume adjustment.
7. Empty the cup, podholder and push again for one cup setting, measure the volume output with a graduated beaker. In the table you can find the requirements for the minimum / maximum volume output cc/mL values depending from the country version:

One-cup setting, Including Pod holder, water spec. (Without Coffee pod)		
	Min. water cc/mL	Max. water cc/mL
Spanish version	51	71
France version	101	121
General version	123	143

8. Unplug the appliance from the mains.
9. Press the 1- and 2 cup button simultaneously and plug the mains on.
10. When above step succeeded the LED will turn on continuously.
11. Depending if the volume has to de- or increase you have to push the one- or two cup button.
Every time you push the 1- or 2 cup button the LED will turn off for 0.5 second (feedback to user) and the pump time will be shortened or lengthened for 0.5 seconds depending which button was pushed.
Pushing 1 cup button pump, time will be **shorten** with 0.5 sec is approximately - 3.5 cc/mL (less coffee)
Pushing 2 cup button pump, time will be **lengthen** with 0.5 sec is approximately + 3.5 cc/mL (more coffee)
When the volume has to increase with 10 cc for example, push the 2 cup button 3 times. The new value will be stored when you switch the appliance off by **pushing** the main switch. (LED will turn off).
12. Turn appliance on again and brew one cup, measure the volume. In case the volume is not within specification repeat steps 7 - 12.
13. End.

Filling procedure:

Please note, the software of the Senseo Viva Café has changed, compared to predecessor Senseo's! The filling procedure known from predecessor Senseo's is no longer available.

The command originally used to initiate the filling procedure (cold flush: pushing both the 1-cup and 2-cup buttons simultaneously) will now start the decalcification process.

To perform a cold flush of the appliance, it has to be reset to factory default. See topic "**Restoring the Boiler_empty_flag to factory default**" below.

As a back-up, when the appliance is in factory default setting, the cold flush will also be initiated when the user presses either the 1-cup or the 2-cup button. This functionality is only available after restoring the **Boiler_empty_flag** to factory default.

Restoring the Boiler_empty_flag to factory default

Under some circumstances it might be necessary that the boiler of the Senseo is emptied.

This, for instance, during wintertime were the possibility exists that the boiler becomes frozen during transport.

For those occasions it is useful to restore the **Boiler_empty_flag** to production default.

Bringing the Senseo back into production status, has the benefit that the flush routine will be activated automatically when installed by the consumer, see topic **Automatic filling procedure**.

To SET the **Boiler_empty_flag**:

Keep the 1-cup button pressed while plugging in the power cord of the appliance.

The main switch LED will blink very rapidly for approximately 1 second.

To check if the **Boiler_empty_flag** is really set, you should reconnect the power cord a second time to the net and push the main switch.

The main switch LED should light continuously.

Pos	Service code	Description	Remark
1	4222 259 48381	Padholder assy 1-cup	Panther Black
2	4222 259 48391	Padholder assy 2-cup	Panther Black
3	4222 247 42550	Collector	
4	4222 259 45071	Spout cover	Metal
5	4222 259 48241	Spout assy	Black
6	4222 240 00521	Drip tray cover	
7	4222 247 63012	Drip tray	Black
8	4222 259 46431	Water container assy	Dark Grey
9	4222 240 00571	Lever	Metal
10	4222 247 63071	Pushrod	
11	4222 259 45901	Selection button assy	
12	4222 259 45921	Display assy	230 V
13	4222 240 01410	Slider spring	
14	4222 259 48362	Brew chamber assy	Beluga
15	4222 247 06810	Brew chamber seal	
16	4222 240 05990	Ejector pin	
17	4222 247 41920	Distribution disk	
18	4222 259 45043	PCB assy	White LED HE 230 V
19	4213 247 05256	Foot	
20	4222 259 45341	3-Way valve	
21	4222 259 44270	Boiler assy	V7.0 - 230 V
22	4222 247 06591	Hose	
23	4222 247 05130	O-ring	(NTC)
24	4222 259 47301	NTC assy	
25	4222 259 37240	Pump	230 V
26	4222 247 64731	Valve outlet	Panther Black
27	4222 259 48371	Back Cover assy	Beluga
28	4222 247 05510	Corrugated tube	
 30	4222 259 48332	Base plate	Beluga

EXPLODED VIEW

HD7835/10 / HD7835/11

