

Service
Service
Service



Philips Consumer Lifestyle

Service Manual

PRODUCT INFORMATION

- This product meets the requirements regarding interference suppression on radio and TV.
- After the product has been repaired, it should function properly and has to meet the safety requirements as officially laid down at this moment.
- Standby power (switched off) : < 1 W
- Standby power (switched on 30 min) : ± 30 W (room temperature)
- Pressure Coffee system : < 1.6 Bar
- Pressure Steam system : < 1 Bar
- Contents water reservoir : 1200 cc/mL
- Contents milk reservoir : 120 cc/mL
- Auto shut off : 30 min
- Variable Coffee volume : Min, Normal and Max (see Table)
- Colour setting : True Red
- Sap coding : HD7850/80

TECHNICAL INFORMATION

- Voltage : 220 - 240 V
- Frequency : 50 - 60 Hz
- Power consumption : 2650 W
 - Boiler : 1450 W
 - Steam heater : 1200 W

☞☞☞	Coffee volume overview		
	☞	☞☞	☞☞☞
	Min cc/mL	Normal cc/mL	Max cc/mL
France version	80	100	140
General version	80	122	145

Coffee/Milk recipe	Volume (cc)	Weight (g)		Indication temperature for chosen Coffee/Milk recipe very depended from milk inlet temperature.
		max. (g)	min. (g)	
	cc			(°C)
Cappuccino	160 ± 16	156	124	≥ 69
Latte Macchiato	220 ± 24	202	158	≥ 63
Café Latte	190 ± 20	179	141	≥ 67

Build up: Steam circuit

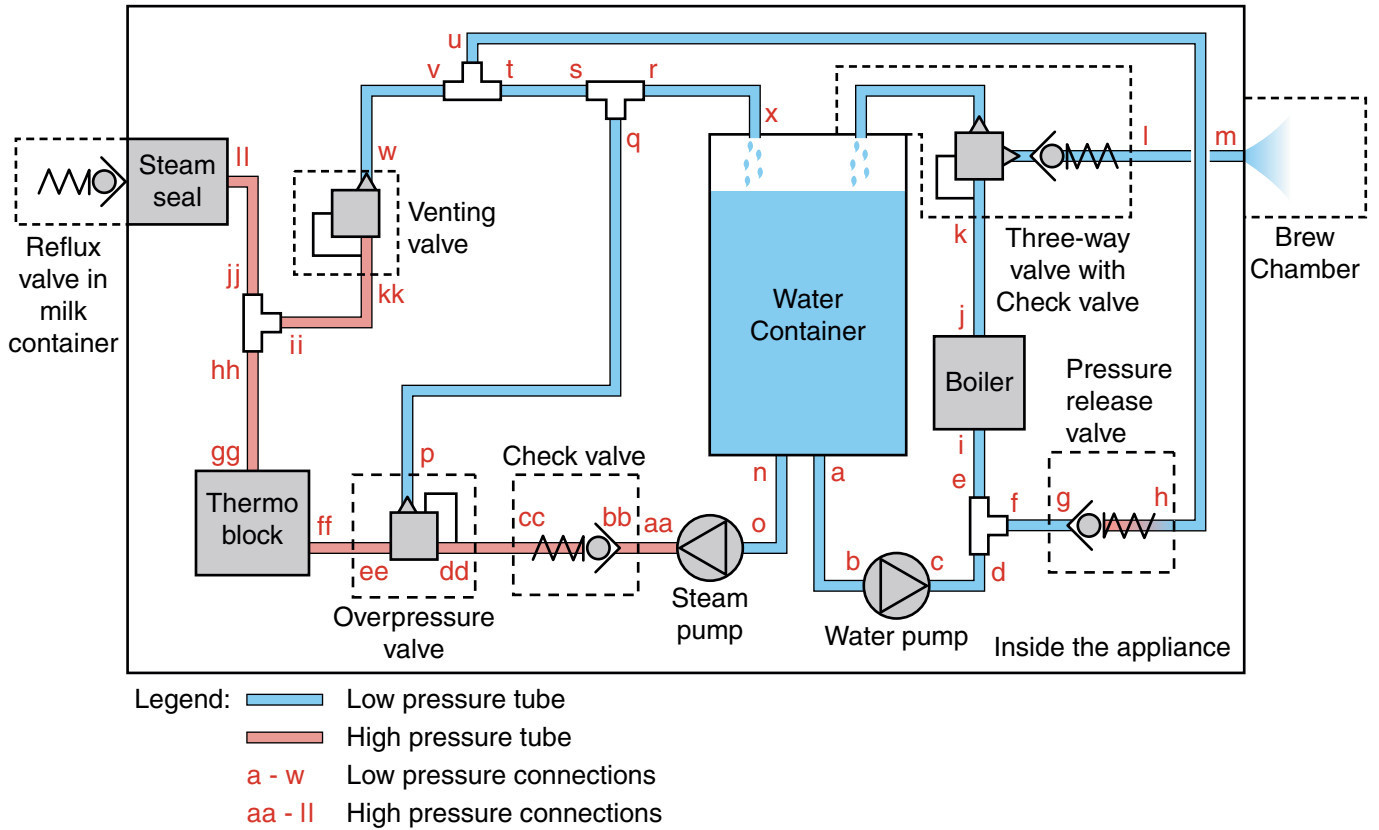

Electrical circuit

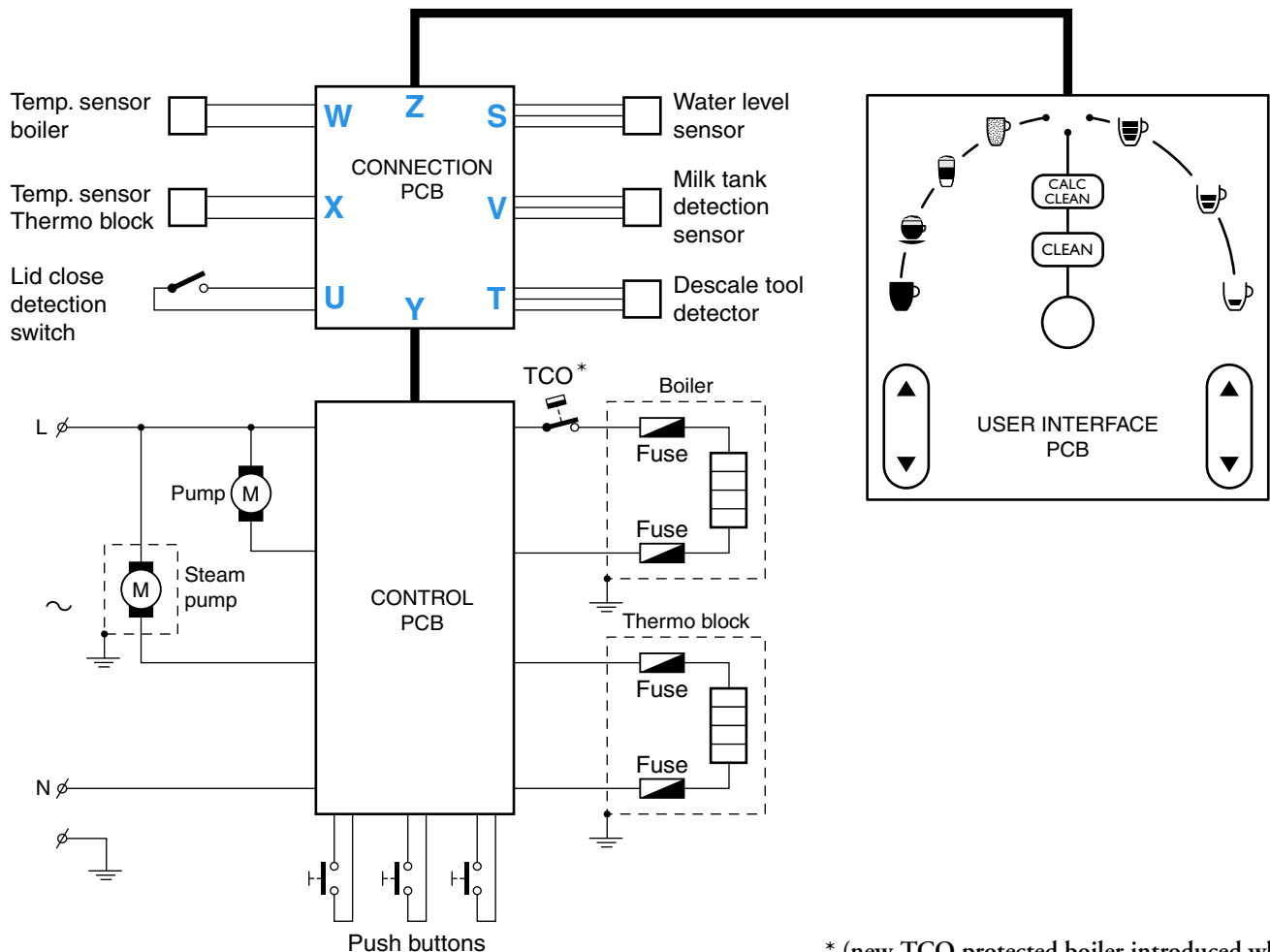

* (new TCO protected boiler introduced wk903)

Remove back cover.

- Remove screws (T15) from the back cover.
- Remove valve outlet.
- Start at the upper side of the back cover and stick a screwdriver between the back cover and lid cover and gently pull the back cover from the appliance so that a little chink between back cover and lid becomes visible.
- Put the screwdriver into the 2 rectangular holes (snap locks) at the back and gently pull the screwdriver such away that the lips of the snap locks are bent outwards.
- If both clicks positions are loose, it is possible to remove the back cover.
- Reassemble follow steps backwards.

Remove brew chamber:

Removing Brew chamber head handle as follows:

- Remove boiler from the snap lock position of the brew chamber.
- Gently lift the backside (see picture) of the brew chamber up and unhook the two snap locks on front with help of a screw driver.

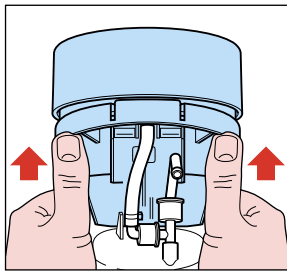

- Remove connection PCB + PCB cover.
- Remove 3 way valve and electronic connectors (U & Z) from the connection PCB.
- Reassemble follow above steps backwards.

Remove the “lid closed” detection micro switch.

Disassemble brewing head.

- Unlock the snap lock which is holding the micro switch assembly. (see picture for detail)

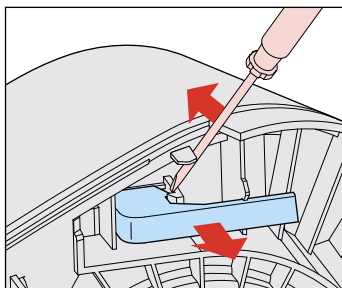

- Gently pull out the switch assembly.
- Reassemble follow above steps backwards.

Remove brew chamber cover to reach user interface PCB.

- To remove the brew chamber lid cover place the screwdriver on the positions (see picture) and lift the cover over the snap locks on both positions.

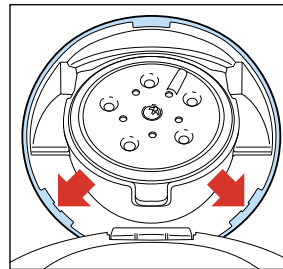

- The cover lid can now be lifted a little.
- Remove the complete cover by unlocking the pushrod from the brew chamber.

- The user interface PCB can be removed by unscrewing 3 screws (T8)
- Reassemble follow steps backwards.

Removing the “de-scaling Hall sensor” detector / steam connection

- To be able to remove the Hall sensor, first unhook the spout out of the housing.
- Hall sensor assy can be taken out.
- To disconnect the steam connector rotate it clockwise and pull out of the spout.

To reach the components like pump, PCB, steam heater placed on the base.

- First remove back cover, brew chamber, 3-way valve, steam pump and boiler.
- Remove the 4 Torx T15 screws (two at the base and two at the housing part).
- Bend the 2 click snap locks with a screwdriver (see base), the housing can now be removed.
- To remove the rest of the housing unlock the 4 snap locks at the base and gently pull of the front cover.
- To reassemble follow above steps backwards.

OPTIONAL (accessories)

- HD7010 Latte Select Milk Container.
- 4222 259 43670 Senseo Descaler kit

Descaling



Regular descaling will prolong the life of your appliance and will guarantee optimal brewing results for a long time.



- Follow the steps in the section headed “Preparing the appliance for use” see DFU (Direction for Use manual)
- Instead of only water use a mix of water and Lemon sour.
- For the best result leave the mix of water and Lemon sour for about 30 Minutes in the appliance, before you start with flushing the appliance.
- To get the best results repeat above-mentioned step once or twice.
- When finished, flush the appliance twice by repeating the above-mentioned steps only use water instead.

Volume adjustment

The PCB circuit board makes it possible to adjust the volume output by means of pushing the one-cup and two-cup user controls.

How to adjust the volume output:

1. Be sure the boiler is filled properly, other wise perform fill procedure see DFU for instructions.
2. Switch appliance on and wait until the unit is ready to brew.
3. Select the Coffee function  and select normal volume 
4. Be sure a **pod holder** is placed, but **without** a Coffee POD. (Only adjusting with **plain** water)
5. Place a cup on the drip tray cover and push the one-cup button.
6. When the appliance has finished it is stabilized to perform the volume adjustment.
7. Empty the cup, podholder and push again for one cup setting, measure the volume output with a graduated beaker. In the table you can find the requirements for the minimum / maximum volume output cc/mL values depending from the country version:

One-cup setting, normal volume, Including Pod holder, water spec. (Without Coffee pod)		
	 Min. water cc/mL	 Max. water cc/mL
France version	104	120
General version	125	141

8. Unplug the appliance from the mains.
9. Press the one and two cup button simultaneously and plug the mains on.
10. When above steps succeeded the main on/off switch- , one cup- and two cup button led will be on.
11. Depending if the volume has to de- or increase you have to push the one- or two cup button.
Every time you push the 1- or 2 cup button the LED will turn off for 0.5 second (feedback to user) and the pump time will be shortened or lengthened for 0.5 seconds depending which button was pushed.
Pushing 1 cup button pump, time will be **shorten** with 0.5 sec is approximately - 3.5 cc/mL (less coffee)
Pushing 2 cup button pump, time will be **lengthen** with 0.5 sec is approximately + 3.5 cc/mL (more coffee)
When the volume has to increase with 10 cc for example, push the **2 cup** button 3 times.
The new value will only be stored when you switch the appliance off by **pushing** the main switch.
(LED will turn off)
12. Turn appliance on again and brew one cup, measure the volume. In case the volume is not within specification repeat steps 7 – 11.
13. End.











Service test routines.

Sensors and buttons check mode.

The Senseo is equipped with a lot of sensor and push buttons. To be able to check the function of those components a special service routine has been applied.

1. Unplug the appliance from the mains.
2. Press the on/off- and two cup button simultaneously and plug the mains on.
3. When above steps succeeded the main on/off switch- , one cup- and two cup button led will be on.

In below table you can find which sensors or buttons correspondent with the indication of the user panel. For example push the one cup button and the  light will be on.

Selected function	User panel reaction
One cup button	
On/off button	
Two cup button	
Calc-clean button	
Coffee select button	
Volume select button	
Close lid detection switch	
Hall sensor milk container	
Hall sensor descale tool	
Hall sensor Tank low volume	
Hall sensor Tank high volume	 

Automatic filling procedure:

The Senseo PCB contains an automatic filling procedure software routine.

This fill routine is only meant for **back-up**.

Normally the consumer has to follow the guidelines stated in the DFU.

The filling procedure functions as follows:

The consumer has to fill the water container and has to plug the appliance on the mains.

When the Senseo main switch has been pushed the main switch led, one- and two cup led will light continuously.

This is only the case when the Senseo has not finished the filling procedure completely! (**First use**)

This can be checked by reconnect the power cord a second time to the net and check if the main switch LED will blink very rapidly for approximately 1 second.

When the consumer pushes the one or two-cup button, the Senseo will start automatically the pump to fill the boiler and after that the Steam heater will also be filled.

When the boiler is filled the pump stops pumping. (Pump time approximately 22 seconds)

When the filling procedure has been successful the software will clear a **Boiler_empty_flag** in the Eeprom.

By means of this **Boiler_empty_flag** the system knows the boiler is filled or not!

When the Senseo is switched off or disconnected from the mains, the value of the **Boiler_empty_flag** is stored in the Eeprom chip.

Restoring the Boiler_empty_flag to production default:

Some times it is needed that the boiler of the Senseo have to be emptied.

This for instance in wintertime were the possibility exists that the boiler becomes frozen during transport e.g.

For those occasions it is handy to restore the **Boiler_empty_flag** again to production default in the Eeprom.

Bringing the Senseo back into production status, has the benefit the flush routine will be activated automatically when installed by the consumer, see topic **Automatic filling procedure**.

To SET the **Boiler_empty_flag** can be done by:

Keep the 1-cup button pressed while plugging in the power cord of the appliance.

The main switch LED will blink very rapidly for approximately 1 second.

To check if the **Boiler_empty_flag** is really set, you should reconnect the power cord a second time to the net and check if the main switch LED will blink very rapidly for approximately 1 second.

Pos	Service code	Description	
1	4222 259 41850	Padholder assy 1-cup	Basic Grey
2	4222 259 41860	Padholder assy 2-cup	Basic Grey
3	4222 259 41730	Milk container assy	Translucent Bright White
4	4222 240 00320	Driptray cover	
5	4222 259 42340	Driptray assy	True Red
6	4222 259 41510	Water container assy	Translucent Dark Grey
7	4222 259 42310	Decalcification dummy assy	
8	4222 259 41820	Lasered/printed lid panel	True Red
9	4222 247 60170	Lever	Basic Grey
10	4222 247 58270	Push rod	
11	4222 240 01410	Slider spring	
12	4222 259 42420	User interface PCB assy	Red
13	4222 247 06810	Brew chamber seal	
14	4222 240 05990	Ejector pin	
15	4222 247 41920	Distribution disk	
16	4222 247 58910	Collector	
17	4222 247 60200	Spout housing cover	Basic Grey
18	4222 247 58950	Spout lever	Translucent Bright White
19	4222 247 58930	Spout	
20	4222 259 41660	Sensor decalcification assy	
21	4222 259 42440	Steam connecting assy	
22	4222 247 60140	Spouthousing	Basic Grey
23	4222 259 42160	Venting valve assy	
24	4222 259 41610	Sensor milk container	
25	4222 259 41180	Safety valve assy	
26	4222 259 42680	One way valve	
27	4213 247 05250	Foot	
28	4222 259 42430	Lid switch lid close detection assy	
29	4222 259 41230	Steam pump	CEME E151
30	4222 259 41210	Sensor water level + PCB housing	
31	4222 247 60240	Valve outlet	Basic Grey
32	4222 259 41470	Valve assy zebra	
33	4222 259 41840	Backcover assy	Basic Grey
34	4222 247 05510	Corrugated tube	
35	4222 259 41870	Fuse assy welded (2 pieces)	
36	4222 259 37240	Pump	ULKA HF 230 V -50 Hz
37	4222 259 41750	Thermo block assy	
38*	4222 259 35440	Boiler assy	V7.0 - 230 V
39	4222 247 05130	NTC O-ring	
40	4222 259 41620	NTC boiler assy	
41	4222 247 60010	Driptray shaft support	
42	4222 259 41200	PCB assy base	Red
43**	4222 259 43650	Pressure release valve	
44	4222 247 60260	T-piece	
45	4222 247 56920	Milk Tube	
46*	4222 247 61940	TCO cap	
47	4222 259 42890	Brew chamber assy	True Red
48	4222 247 60123	Housing	True Red
49	4222 247 60661	Driptray carrier	True Red
50	4222 259 42853	1-cup button	
51	4222 259 42871	On/Off button	
52	4222 259 42863	2-cup button	

* New components introduced wk903 in production.

** Not used in production anymore since introduction of new TCO Boiler wk903.
Pressure release valve may only be removed in combination with a new TCO Boiler.

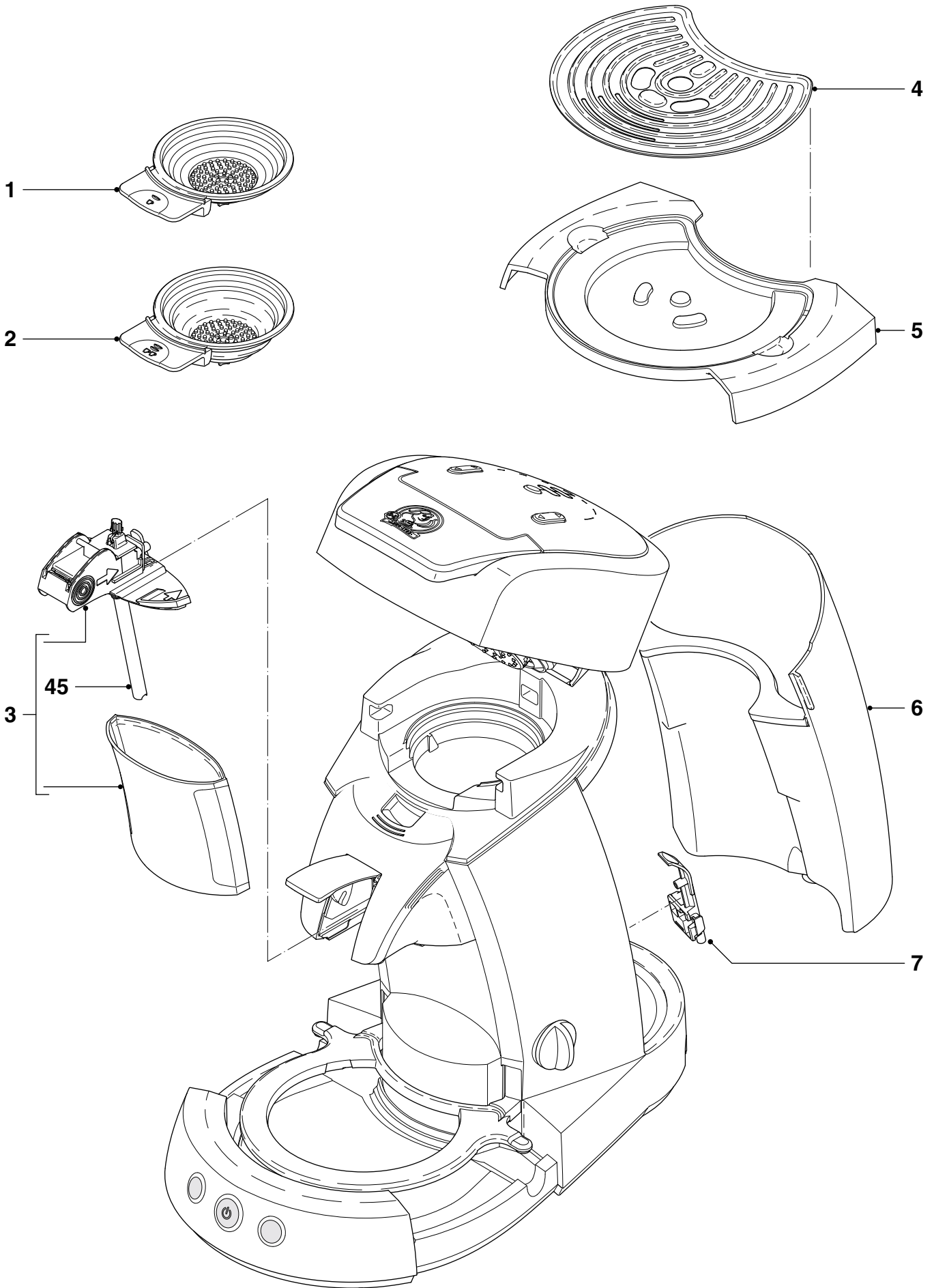

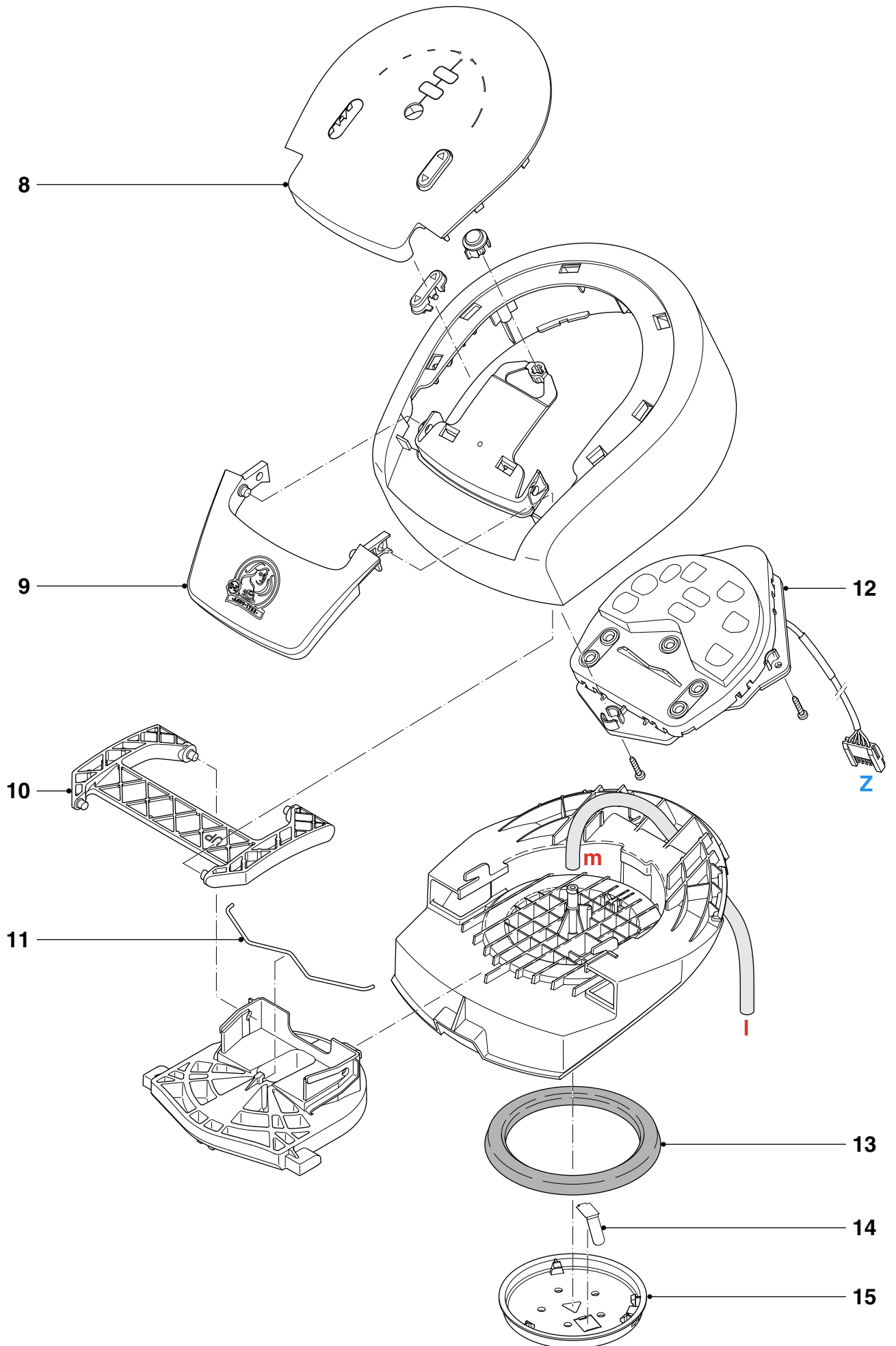

EXPLODED VIEW

HD7850/80

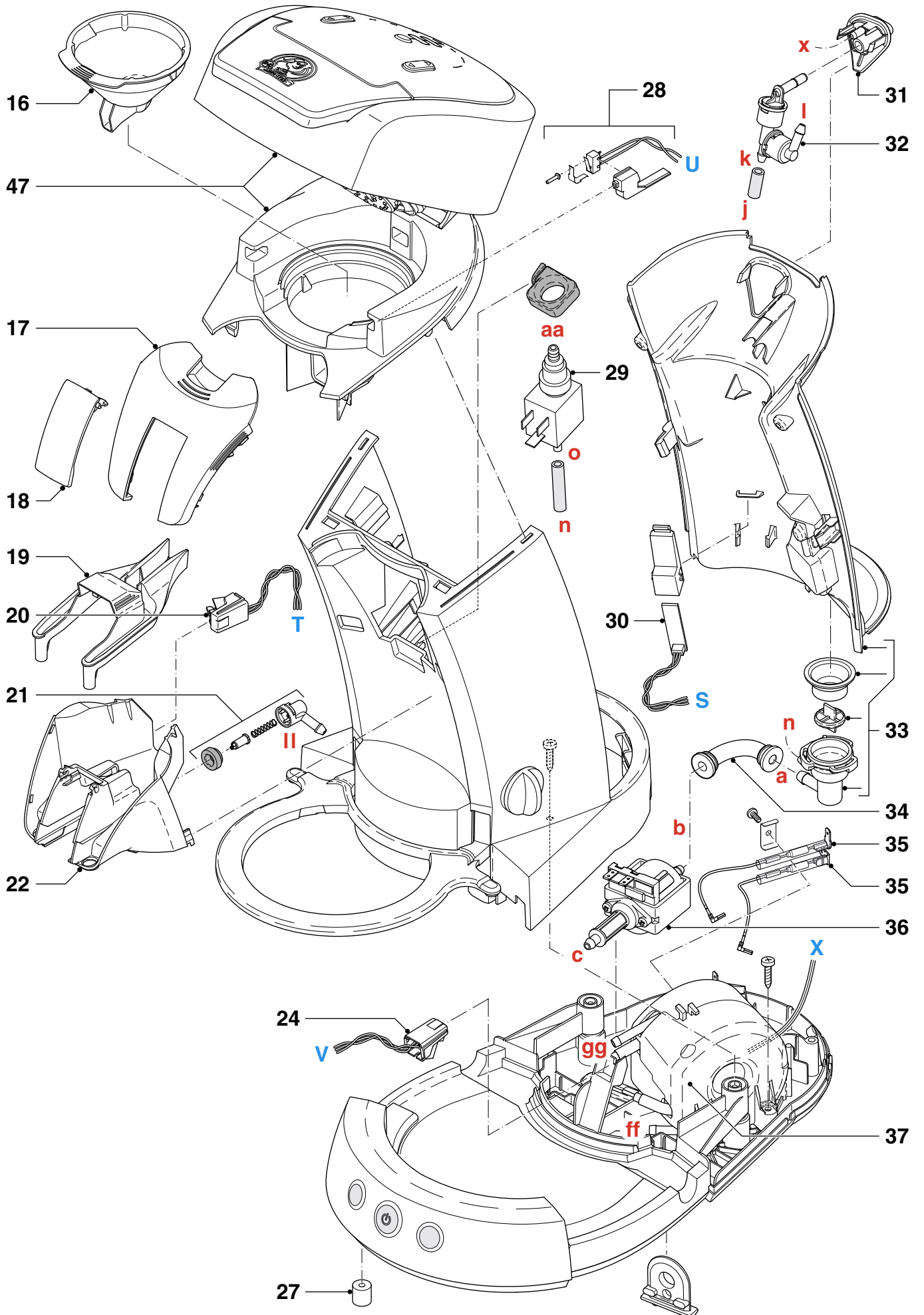

EXPLODED VIEW

HD7850/80

