

# Manual



# Machines



# Service Manual

Revision 00 May 2010



# Manual

# Machines

All parts of this document are the property of Saeco International Group.  
All rights reserved. This document and all the information herein is provided without liability deriving from any errors or omissions. Furthermore, no part may be reproduced, used or collected with the exception of that authorised in writing or in accordance with a contractual agreement.

# Contents

	Page
<b>1. Introduction</b>	
1.1 Documentation required	1
1.2 Tools and equipment required	1
1.3 Material	1
1.4 Safety warnings	1
1.5 Range	2
1.6.1 External machine parts	3
1.6.2 Internal machine parts	4
<b>2. Technical specifications</b>	
2.1 Technical specifications	1
2.2 Descaling frequency	1
<b>3. User instructions</b>	
3.1 Operation, cleaning and maintenance	1
<b>4. Operating logic</b>	
4.1. Water circuit	1
4.2.1 Wiring diagram	3
4.2.2 Electrical diagram	3
4.3 Filter holder	4
4.4 Spherical cappuccino maker and nozzle	4
4.5 Flow meter	5
4.6 Anti-scale filter	5
<b>5. Troubleshooting</b>	
5.1. Causes and solutions	1
<b>6. Standard inspections</b>	
6.1 Repair schedule	1
6.2 Service schedule	1
6.3 Final inspection	2
<b>7. Disassembly</b>	
7.1 Outer elements	1
7.2 Controls support	2
7.3 Boiler support assembly	2
7.4 Pump	2
7.5 Boiler thermostats	3
7.6 Boiler	3
7.7 Shower and valve	3
7.8 Steam pipe	3
7.9 Oetiker clamps	4
<b>8. Notes</b>	

# CHAPTER 1

# INTRODUCTION

### 1.1 Documentation required

The following documentation is required for repairs:

- Instruction booklet of the specific model
- Technical documentation of the specific model (diagrams, exploded drawings)

### 1.2 Tools and equipment required

Besides standard equipment, the following tools are required:

Qty.	Description	Notes
1	Screwdriver	
1	Pliers for Oetiker clamps	
1	AC - DC - Vdc tester	
1	Digital thermometer	Scale Limit > 150°C
1	SSC (Saeco Service Center)	Programmer (for programming and diagnosis mode)
1	Allen wrench	
1	Hexagonal spanner	

### 1.3 Material

Description	Notes
Thermal grease	Thermal resistance > 200°C
Descaler	Saeco descaler
Degreaser	Personal choice
Silicone grease	Safe to use with food

### 1.4 Safety warnings

It is recommended to consult the technical manual of the machine before implementing any operation.

Comply with all applicable standards relating to the repair of household appliances.

Always disconnect the power plug from the mains before beginning repairs on the machine.  
**Simply turning off the main switch is not sufficiently safe to prevent electrical discharges.**

This household appliance is rated as insulation class I.

On completion of the repairs, insulation and dielectric rigidity tests must be performed.

1.5. Range

**A** Nina Bar



**B** Nina Cappuccino

**C** Nina



Aroma



Armonia



Via Veneto



ABC



Via Venezia

	1 A	1 B	1 C	2	3	4	5	6
Pressurised filter holder	X	X	X	X	X	X	X	X
Filter for 1 or 2 coffees	X	X	X	X	X	X	X	X
Adaptor for E.S.E. pods	X	X	X	X	X		X	X
Steam pipe	X	X	X	X	X	X	X	X
Steel boiler	X	X	X	X	X		X	X
Quantity of dispensed coffee saved in memory	X							
Capacity of removable water tank	1.5 l	1.5 l	1.5 l	2.5 l	2.5 l	1 l	1.2 l	1.5 l
Removable drip tray	X	X	X	X	X	X	X	X

1.6.1 External machine parts





### 1.6.2 Internal machine parts

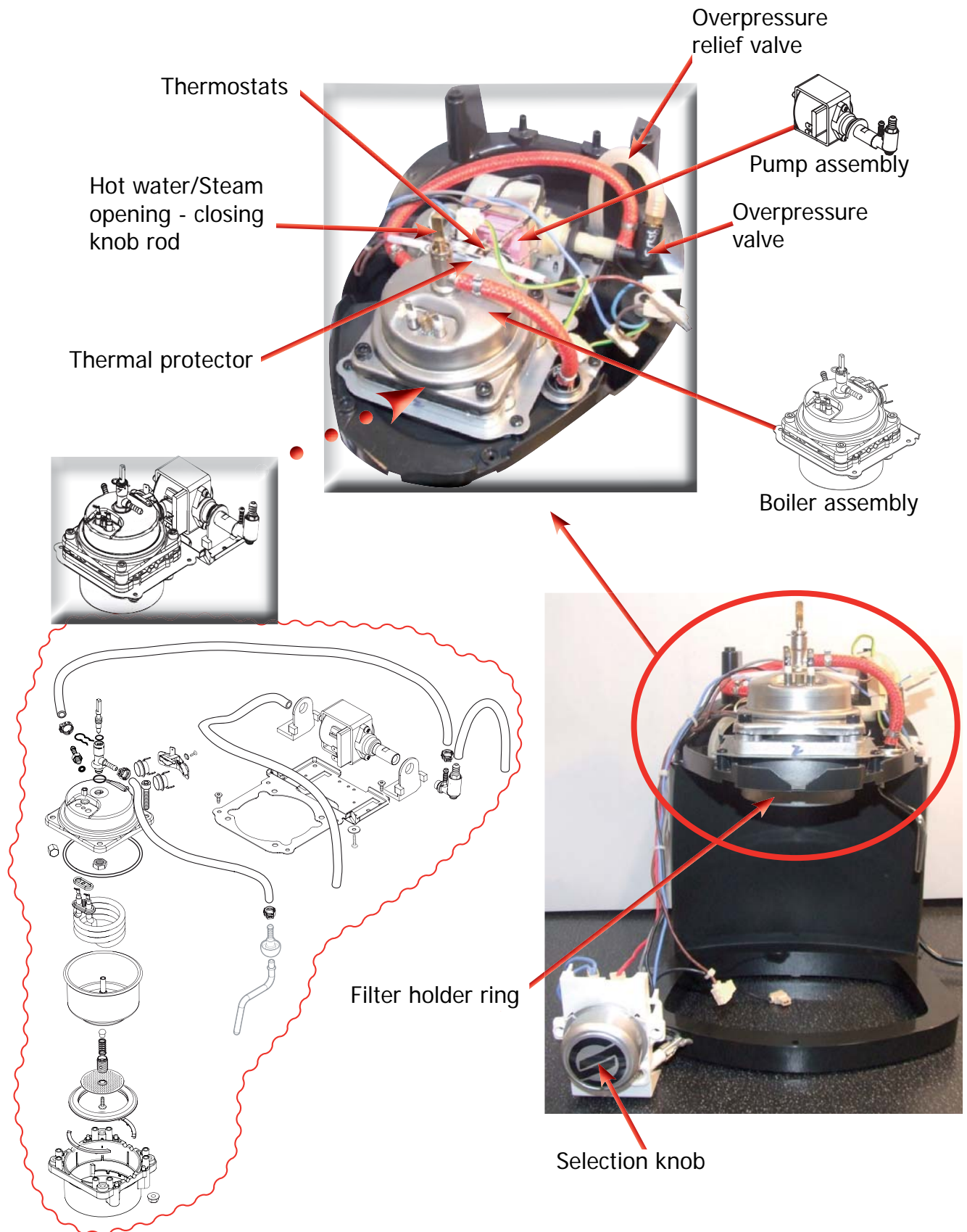

## **CHAPTER 2**

# **TECHNICAL SPECIFICATIONS**



## 2.1. Technical specifications

Safety system:	2 one-shot thermostats (127°C and 95°C) 1 thermal protector > 184°C
Coffee heat exchanger output: Stainless steel	(230/120 V~) 1000 W – for coffee, hot water and steam dispensing
Pump	Ulka Type EP5/S GW approx. 13-15 bar with reciprocating piston and 120°C cutout 48 W, 230V, 50 Hz, 120V, 60Hz 100V, 50/60 Hz
Overpressure valve:	Opening at approx. 16-18 bar
Water filter:	In tank
Flow meter assembly	Only in the single versions with the coffee amount setting
Consumption:	During the heating phase - approx. 5.6 A



## 2.2. Descaling frequency

Descaling frequency			
Hardness	Water hardness	Without anti-scale filter	With anti-scale filter
1	Soft (up to 7°dH)	240 litres (480,000 pulses)	480 litres (960,000 pulses)
2	Medium (7° - 14°dH)	120 litres (240,000 pulses)	240 litres (480,000 pulses)
3	Hard (15° - 21°dH)	60 litres (120,000 pulses)	120 litres (240,000 pulses)
4	Very hard (over 21°dH)	30 litres (60,000 pulses)	60 litres (120,000 pulses)

## **CHAPTER 3**

# **USER INSTRUCTIONS**

### 3.1 Operation, cleaning and maintenance

Operating the machine		
1	Fill the water tank	
2	Fill the coffee bean container	
3	Switch on the appliance	
4	Press to switch on the machine	 / 
5	Heating	The heating phase begins, wait for it to finish
6	Machine ready	The machine is ready to dispense beverages

CLEANING AND TECHNICAL ASSISTANCE		
A	Empty the drip tray	As necessary (float)
B	Clean the water tank	Weekly
C	Clean the filter holder	As necessary
D	Clean the casing	As necessary
E	Descaling cycle	If signalled

Descaling frequency			
Hardness	Water hardness	Without anti-scale filter	With anti-scale filter
1	Soft (up to 7°dH)	240 litres	480 litres
2	Medium (7° - 14°dH)	120 litres	240 litres
3	Hard (15° - 21°dH)	60 litres	120 litres
4	Very hard (over 21°dH)	30 litres	60 litres

# **CHAPTER 4**

## **OPERATING LOGIC**

## 4.1. Water circuit

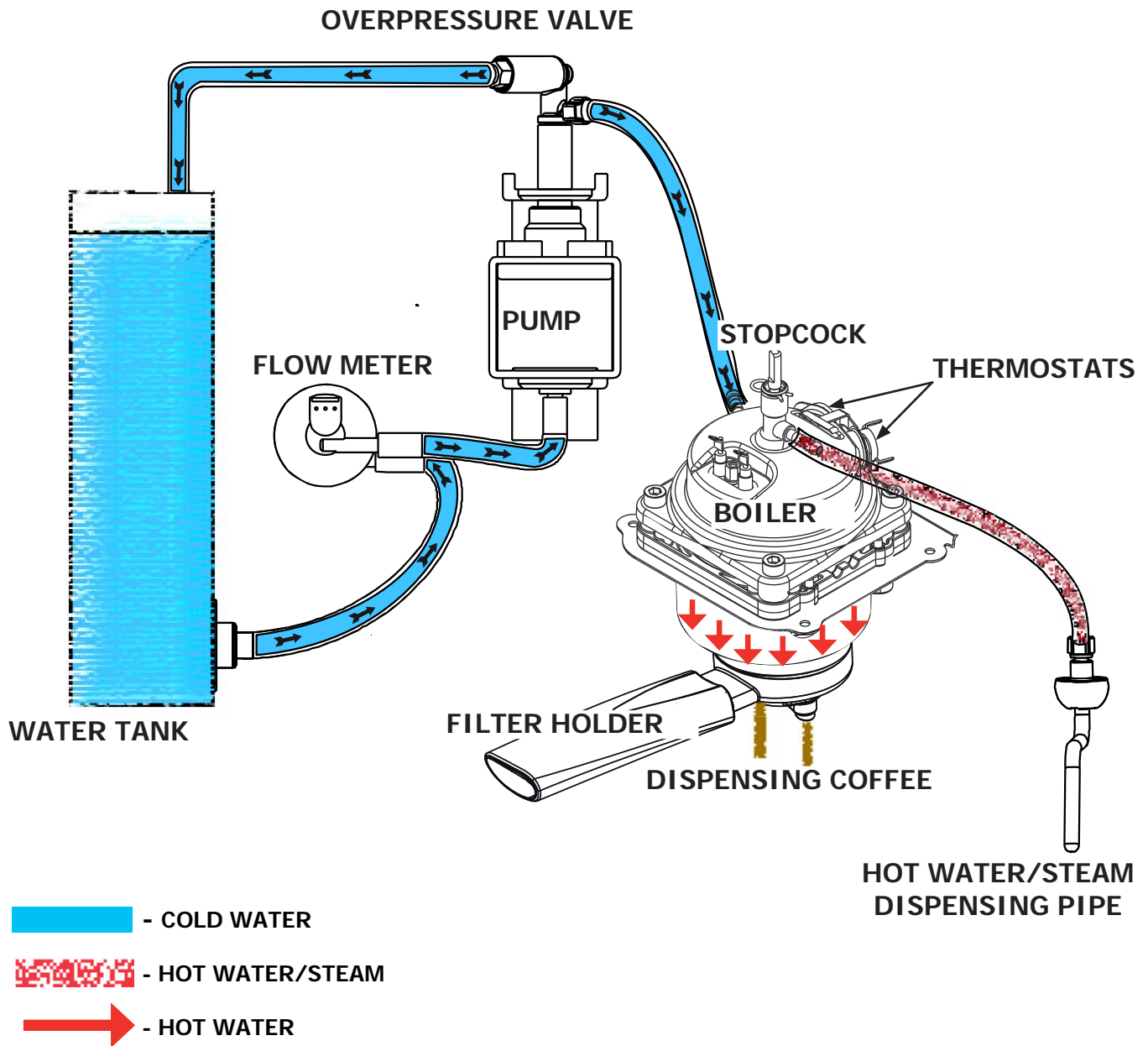
**Specifications and requirements**

Maximum pump operating pressure 15 bar

Maximum pressure in the water/steam circuit does not exceed 15 bar

Hot water temperature 90°C

Steam temperature 125°C

Max coffee thermostat 95°C

Max steam thermostat 127°C

Max thermal protector thermostat 184°C

Max overpressure valve 16/18 bar

**P.S.:** Only the single coffee machines have a flow meter, which can set and save the amount of dispensed coffee via the control board.

Exploded view of a water circuit

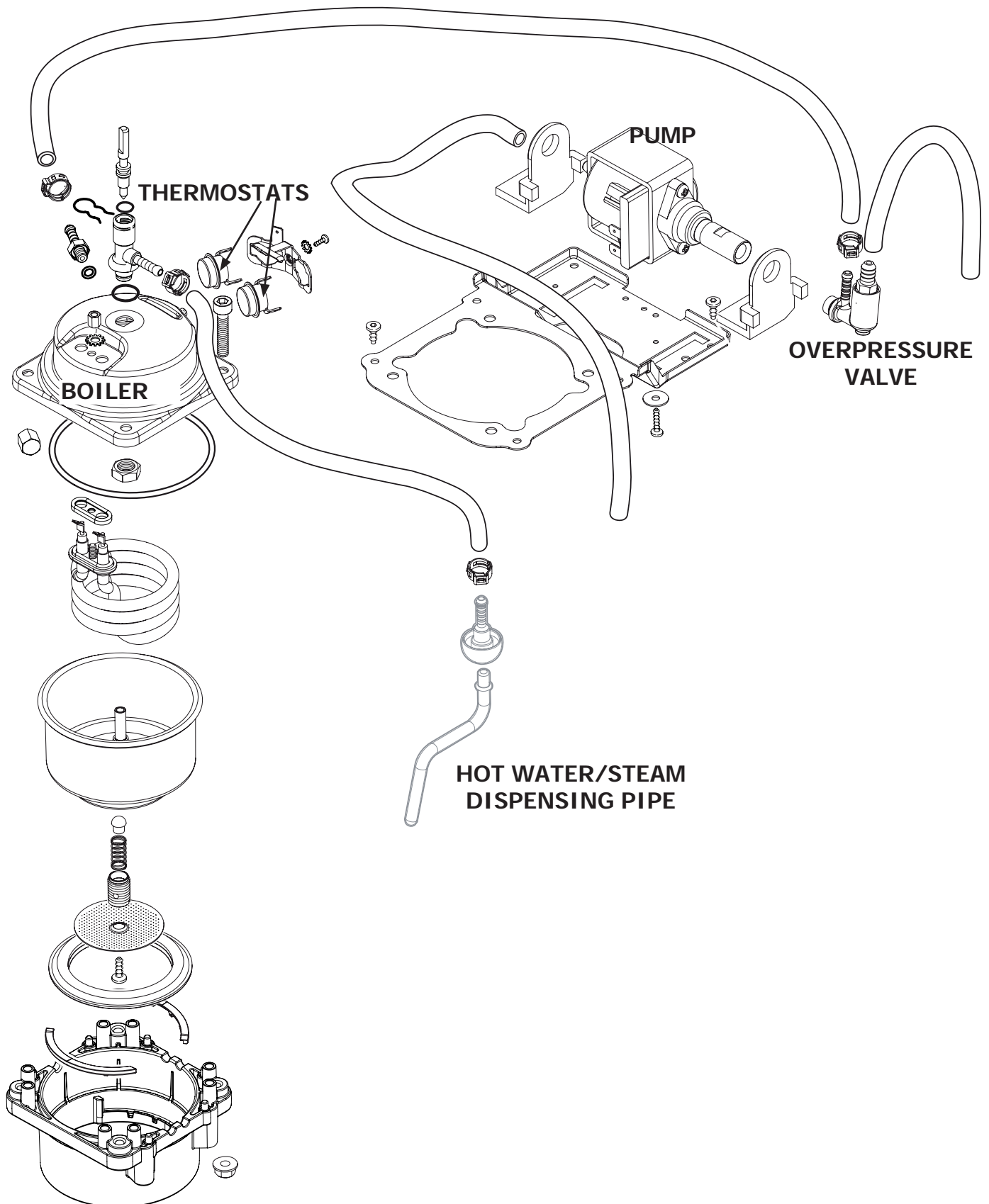

4.2.1 Wiring diagram

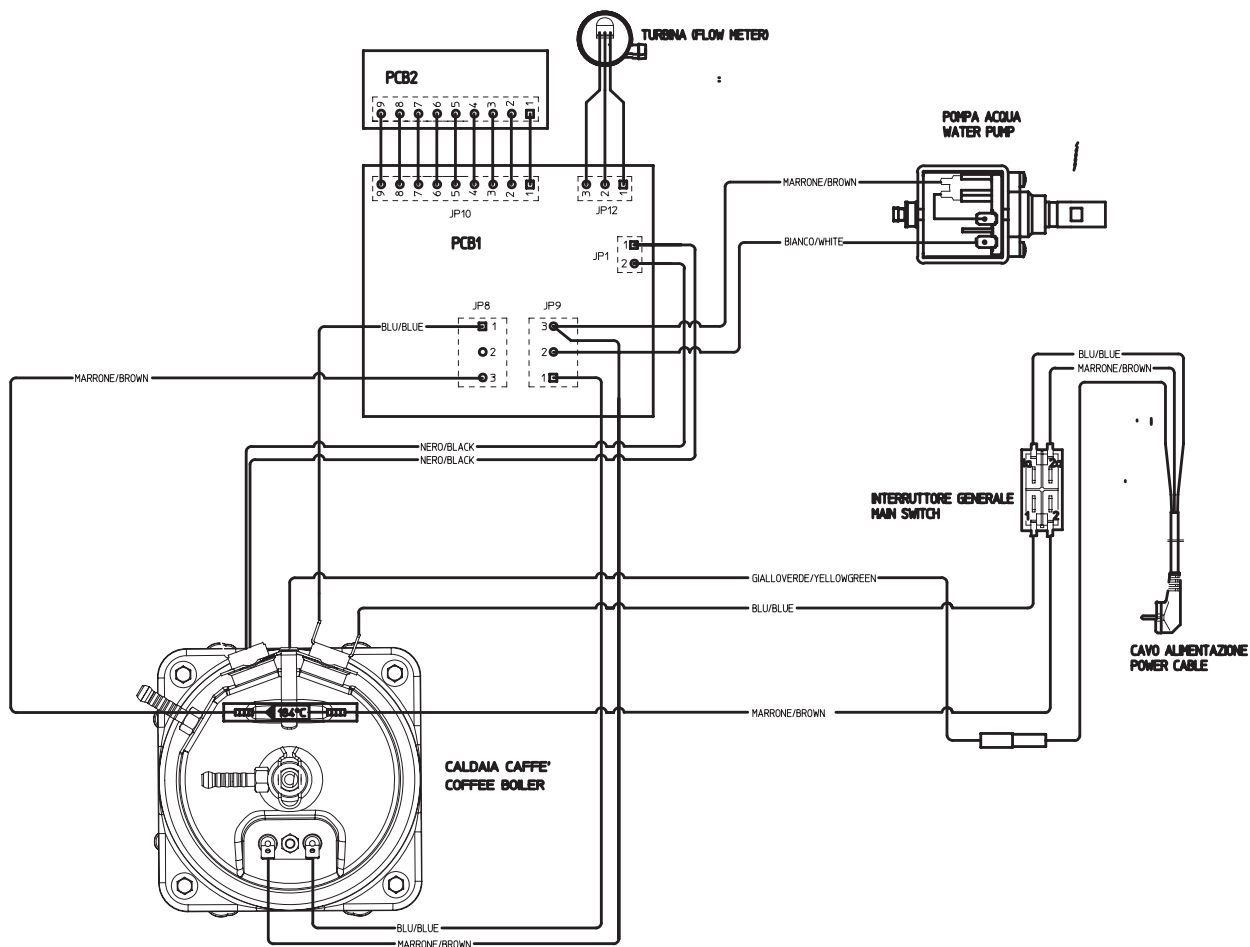

4.2.2 Electrical diagram

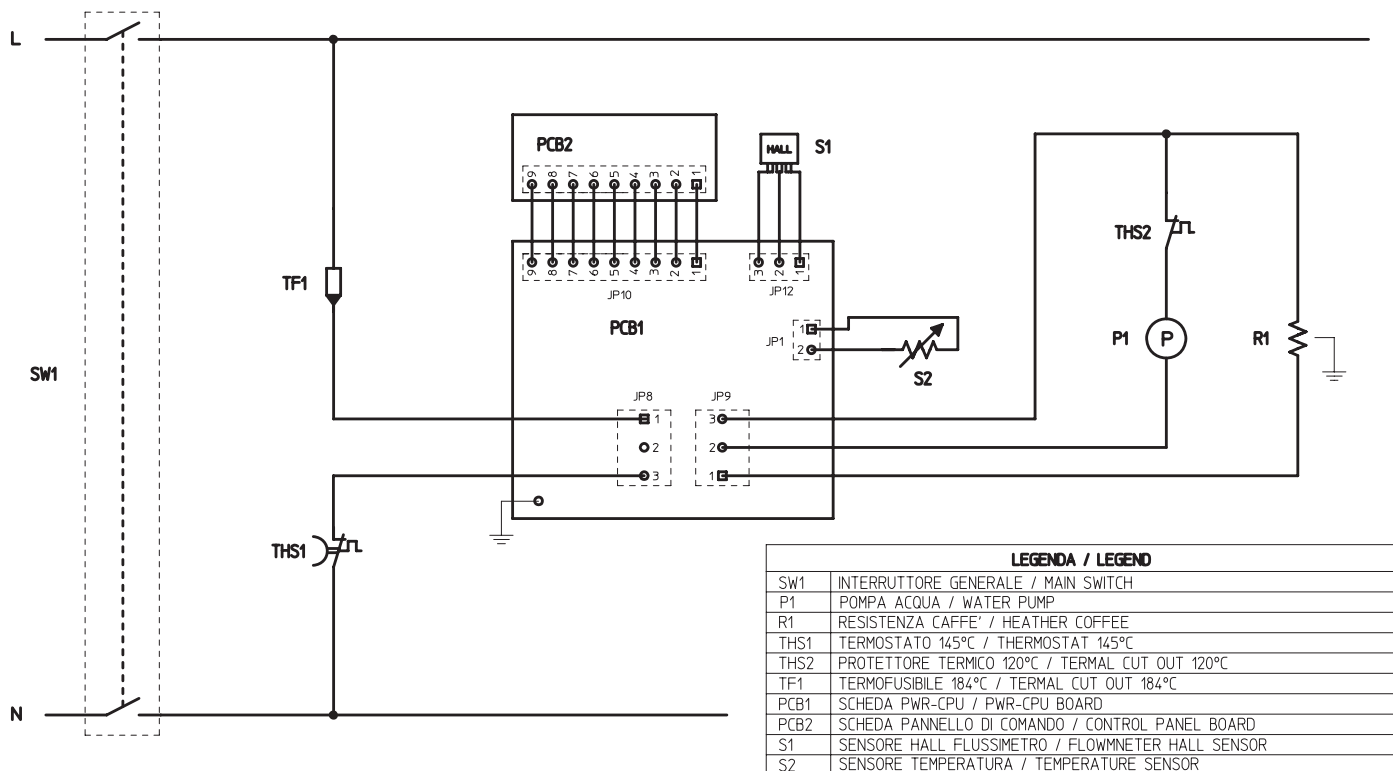



4.3 Filter holder

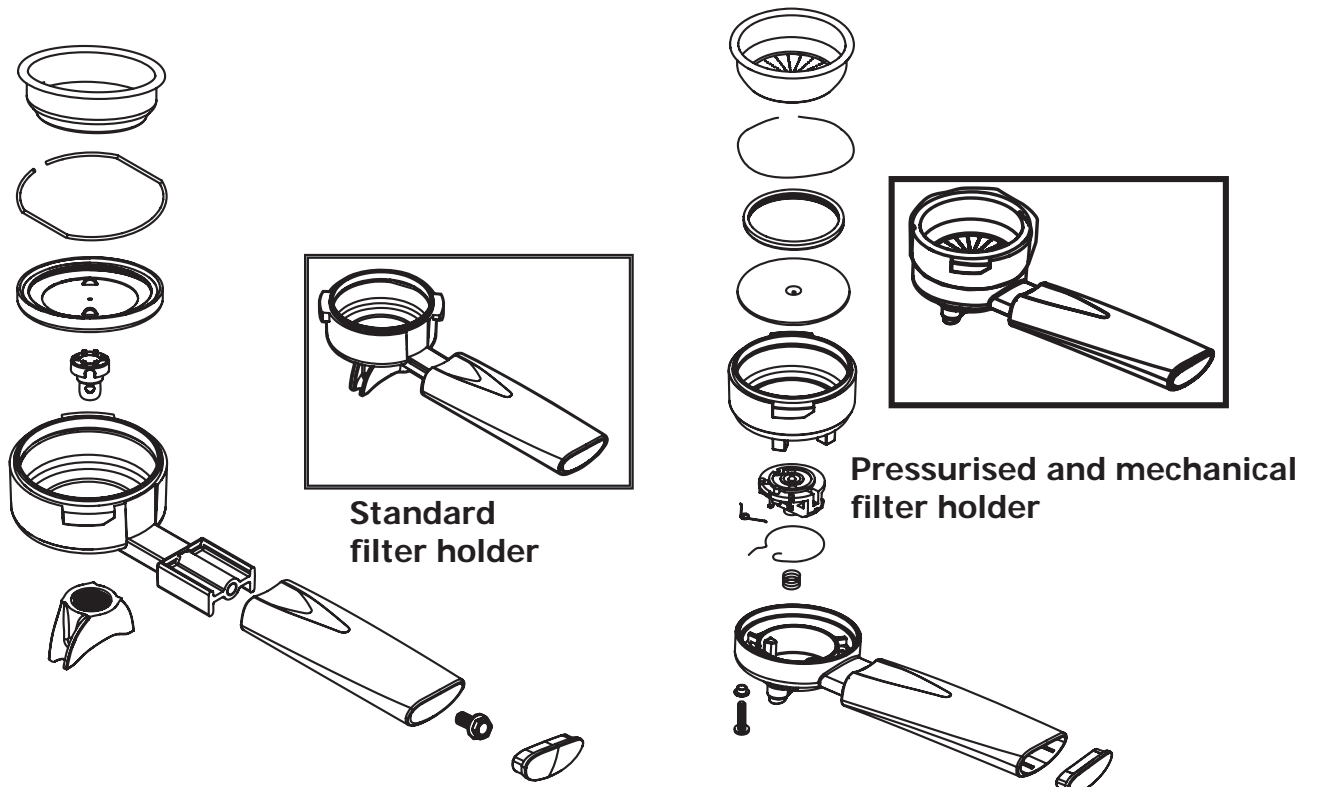

4.4 Spherical cappuccino maker and nozzle

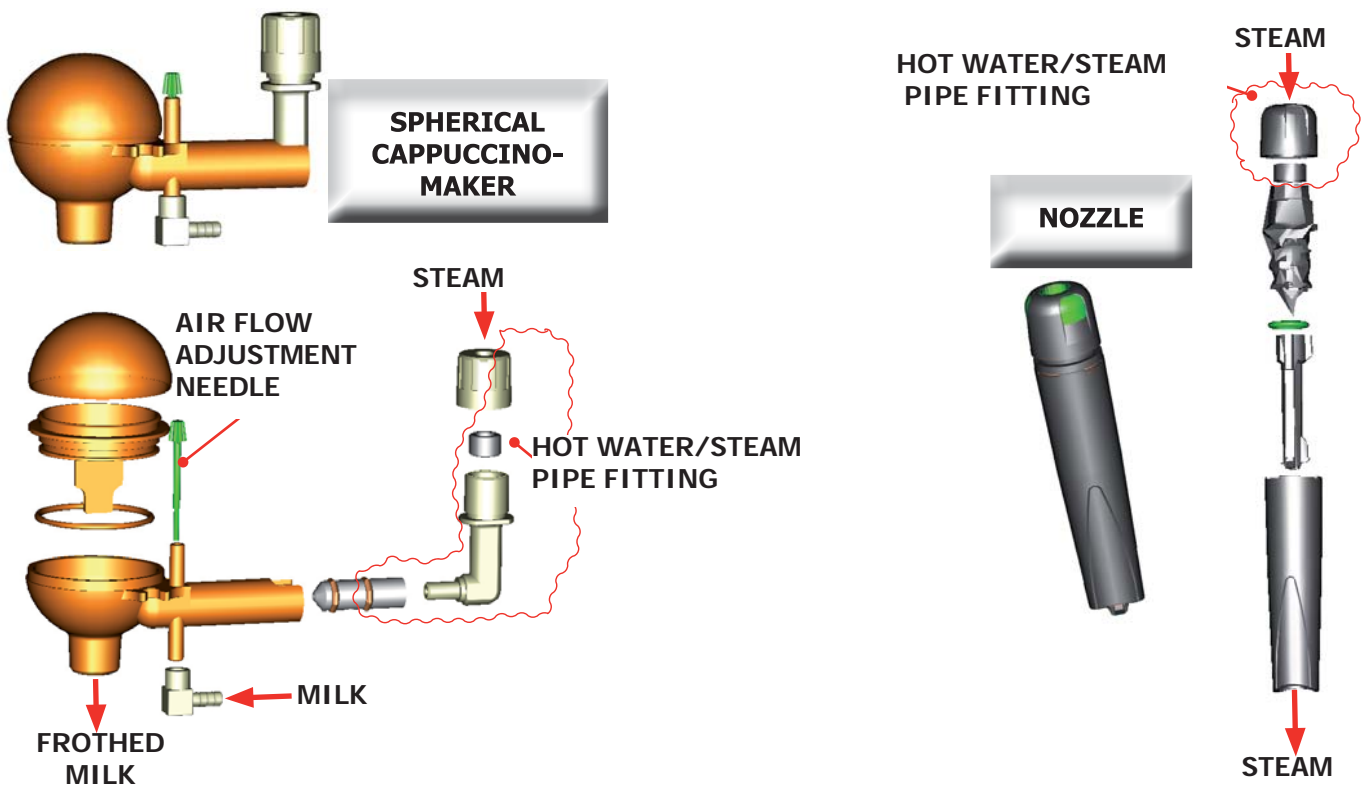

4.5 Flow meter

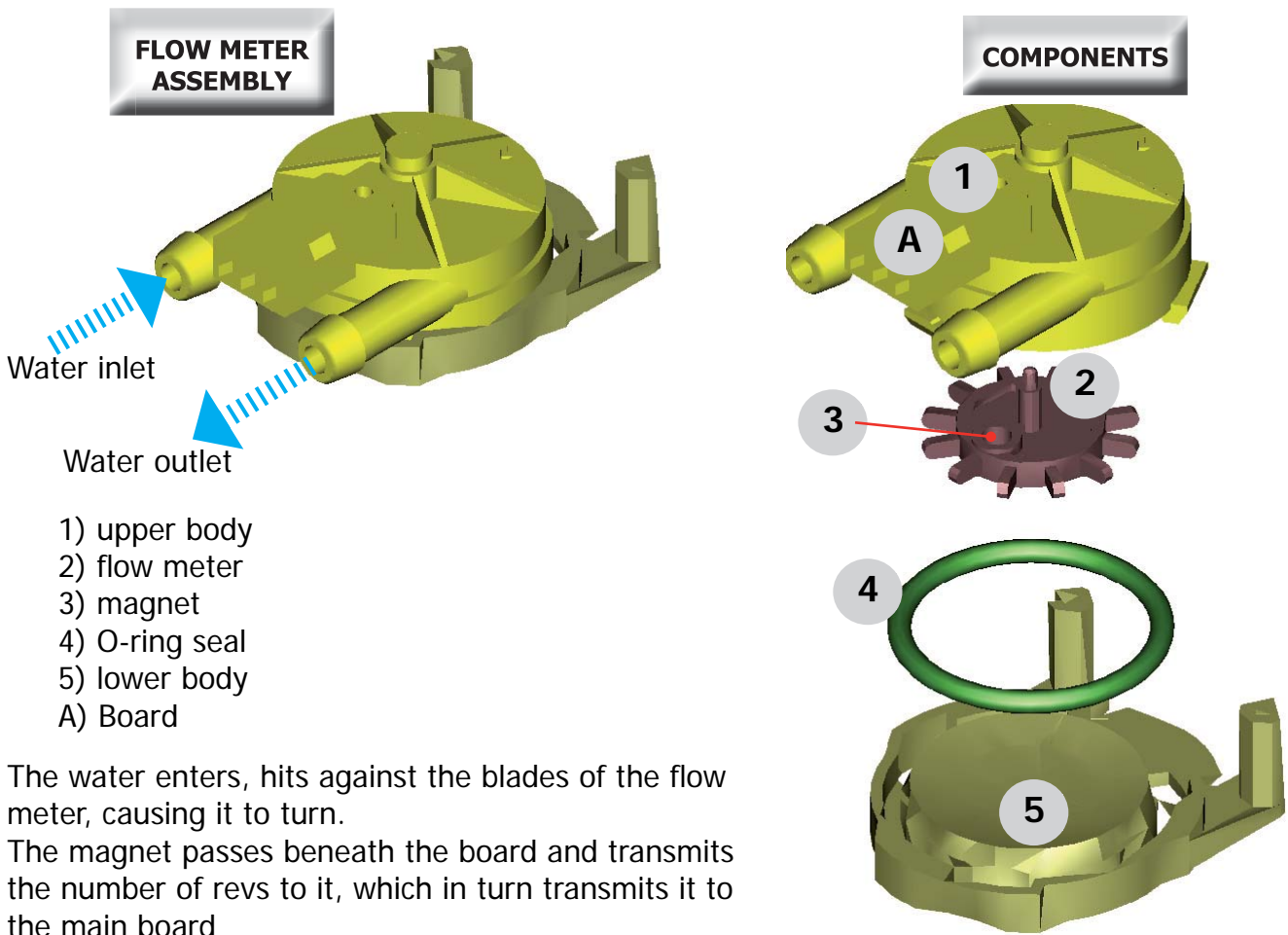

The water enters, hits against the blades of the flow meter, causing it to turn.  
The magnet passes beneath the board and transmits the number of revs to it, which in turn transmits it to the main board

4.6 Anti-scale filter

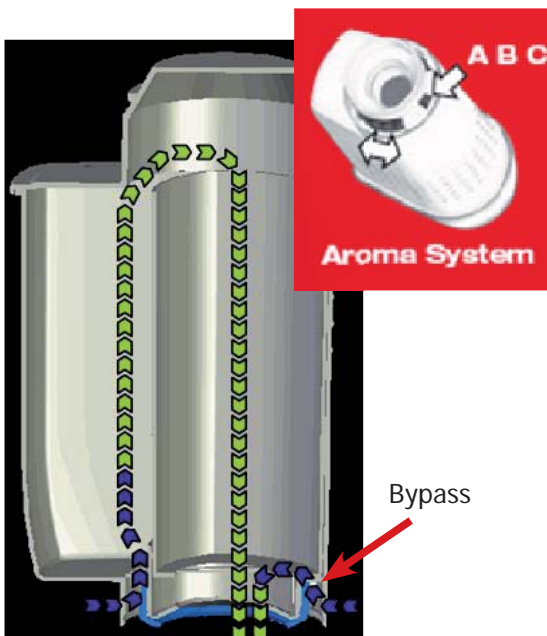

Anti-scale filter

**Function:**

- Reduced limescale deposits that take longer to form.
- Improved water quality.
- Better taste due to ideal water hardness

**Descaling duration / efficiency:**

- - 10° dH
- 60 litres
- 2 months

To obtain a linear characteristic of its effectiveness, throughout the duration of the descaling process, the water is split according to the degree of hardness in a three-phase by-pass (A, B and C).  
See small picture.

# CHAPTER 5

# TROUBLESHOOTING

## 5.1 Causes and solutions

FAULT	POSSIBLE CAUSES	SOLUTION
<b>The machine does not switch on</b>	No power supply	Check the electrical circuit
<b>The machine does not warm up</b>	The thermostats have intervened  The power supply does not reach the boiler	Replace the thermostats (if of the One shot type) If they are manual, reset them If they are automatic, they are reset automatically Check the electrical connections
<b>The pump is very noisy</b>	There is no water in the tank The pump has disengaged from the supports The silicone pipe that carries the water from the tank to the pump is pinched or blocked	Fill the tank Insert the pump into the supports once again Check the water circuit
<b>The coffee is too cold</b>	The filter holder is not inserted for the pre-heating process The cups are cold	Run hot water through the filter holder Pre-heat the cups with hot water
<b>The milk does not froth</b>	The milk is not suitable (powdered or skimmed milk) Dirty nozzle or Cappuccino maker	Use whole milk  Carefully clean the nozzle or the cappuccino maker with water
<b>The coffee flows too quickly and does not form the cream</b>	Little coffee in the filter holder Grinding level too coarse There is a missing component in the filter holder	Increase the quantity Use a different mixture Verify that all the components are in place and installed correctly
<b>The coffee does not flow or it flows in drops</b>	Grinding level too fine The coffee is pressed too much in the filter holder Too much coffee in the filter holder Blocked water channels Blocked filter in the filter holder	Use a different mixture Agitate the coffee  Reduce the amount of coffee Descale the machine Carefully clean the filter
<b>The coffee does not flow from the edges</b>	The filter holder has been inserted incorrectly into the coffee dispensing unit The upper border of the filter holder is dirty The seal of the boiler is dirty or worn Too much coffee in the filter holder	Insert the filter holder correctly Clean the edges of the filter holder  Clean or replace the seal Reduce the amount of coffee

**P.S.:** Refill the water circuit when the machine is first used as well as when the water in the tank finishes.

## **CHAPTER 6**

# **STANDARD INSPECTIONS**

### 6.1. Repair schedule

	Action
1	Visual inspection (damage during transport)
2	Machine data check (plate)
3	Functional check / problem analysis
4	Opening the machine
5	Visual inspection
6	Functional tests
7	Repairing the faults encountered
8	Checking any modifications (view info, etc.)
9	Service activities in accordance with the operating schedule
10	Internal cleaning
11	Functional test with the machine open
12	Assembly
13	Final inspection test
14	Draining the circuit (in winter)
15	External cleaning
16	Insulation test HG 701 (dielectric)
17	Documentation

### 6.2. Service schedule

<b>S</b>	Replacement
<b>ES</b>	Visual inspection
<b>D</b>	Descaling cycle
<b>CF</b>	Functional check

<b>P</b>	Cleaning
<b>TR</b>	Noise test
<b>R</b>	Adjustment

Component	Action	Support/tool
Water filter	<b>P/S/CF</b>	
Water tank lip seal	<b>S/CF</b>	
Pipes, fittings and Oetiker clamps	<b>ES/CF</b>	
Hot water/steam circuit pump	<b>ES/TR/CF</b>	
Water circuit	<b>D/CF</b>	Saeco descaler
Wiring	<b>ES/CF</b>	

**6.3. Final inspection**

Test	Procedure	Support/ tool	Standard	Tolerance
Coffee	2-3 Coffees for adjustment purposes	Measuring beaker		
Noise			Standard	
Amount of cream	Blow into the cup until the cream separates		The cream should come together again completely	
Cream colour			Hazel brown	
Temperature	Reading taken while dispensing	Thermometer	84 °C	± 4 °C
Hot water	Dispense water			
Steam	Dispense steam			



# **CHAPTER 7**

## **DISASSEMBLY**

7.1. Outer elements



Remove the water tank, the water drip tray, the grille and the steam knob.

Upper cover

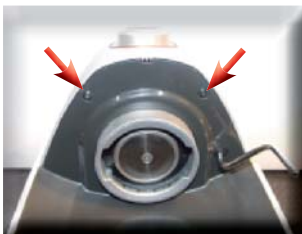

Loosen the screws as shown on the front and rear part of the machine



Lift the cover and loosen the screws as shown

RIGHT and LEFT side covers



Remove the side covers by lifting them upwards



LEFT side cover (note the hooks of the cover)



RIGHT side cover. Remove the connection of the on/off switch from the cover



**7.2 Controls support**

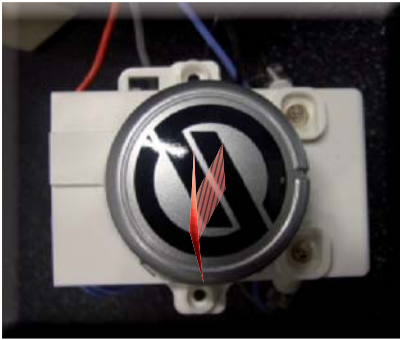

Remove the knob by pulling it outwards

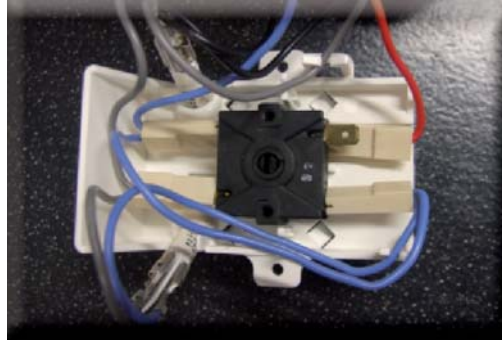

Remove the electrical connections and the two bright indicators

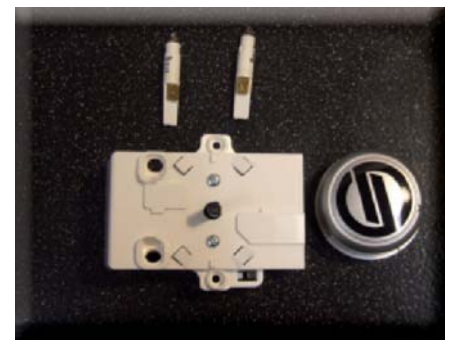

Loosen the screws as shown to remove the rotating switch

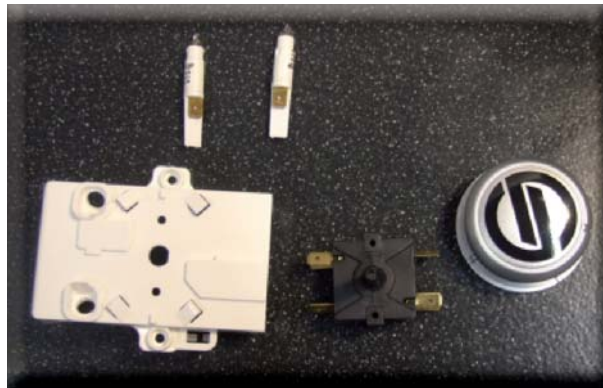

**7.3 Boiler support assembly**

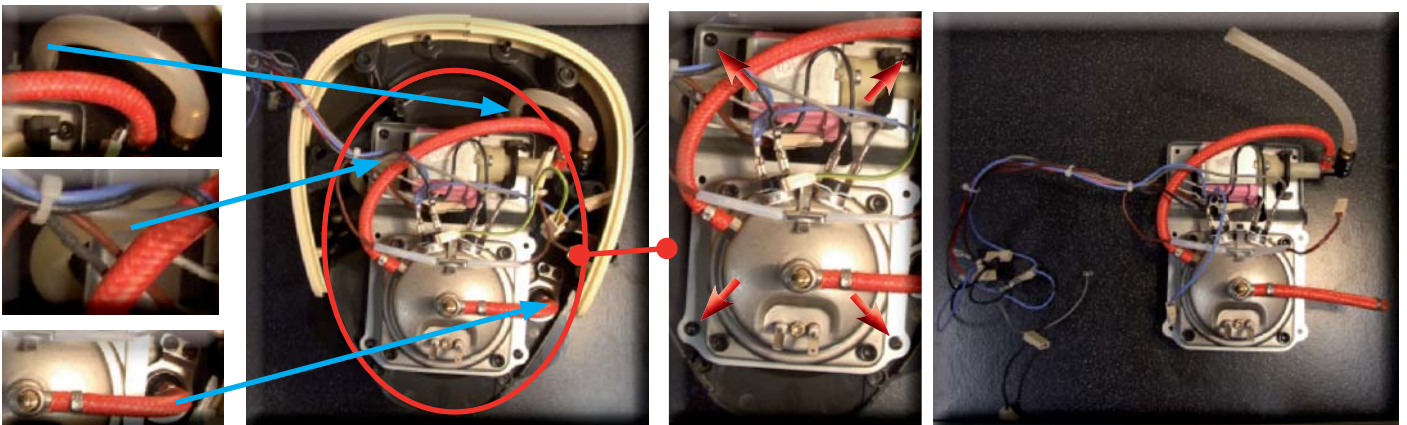

Remove the water connections and loosen the screws as shown

**7.4 Pump**

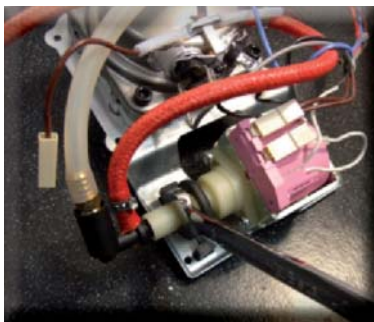

Loosen the overpressure valve

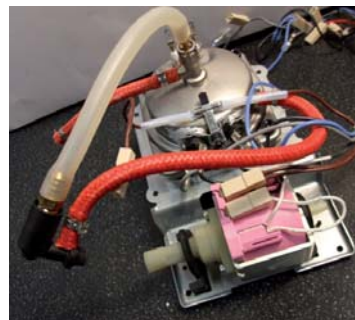

Remove the pump from the supports

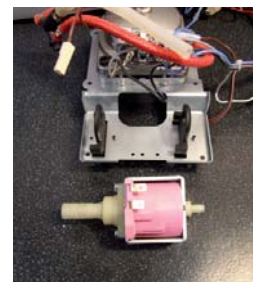



**7.5 Boiler thermostats**

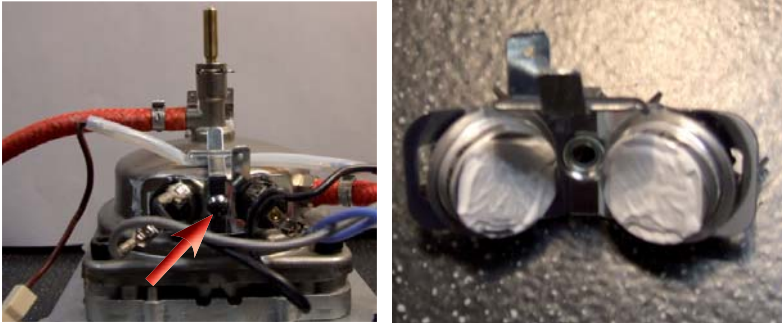

When putting back the thermostats, always apply conductive paste for the thermostat to adhere perfectly to the boiler

Loosen the screw as shown

**7.6 Boiler**

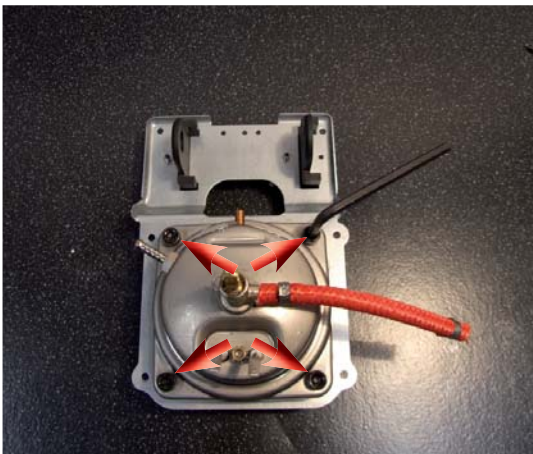

Loosen the screws as shown



Check the internal condition of the boiler (limescale, any breakages, condition of the O-ring seal, etc.)

**7.7 Shower and valve**



Loosen the screw as shown

Shower

Loosen the screw of the valve holder

Check the condition of the shower, valve holder screw, channels (holes not blocked) and verify there is no limescale on any of the parts

**7.8 Steam pipe**

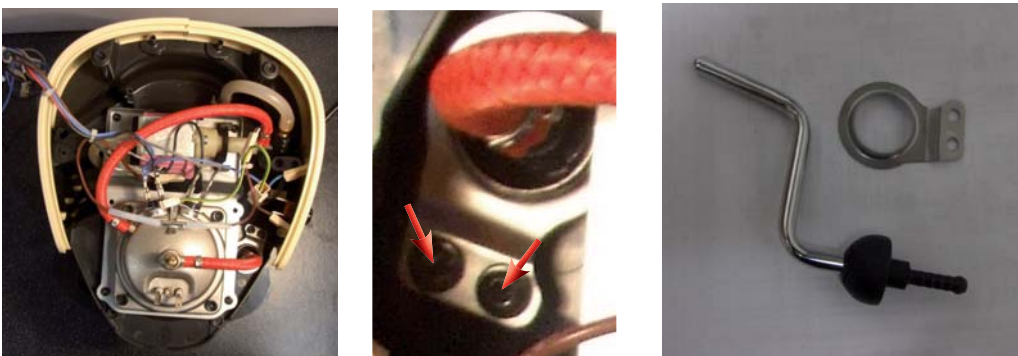

Loosen the screws as shown

## 7.9 Un/installing Oetiker clamps

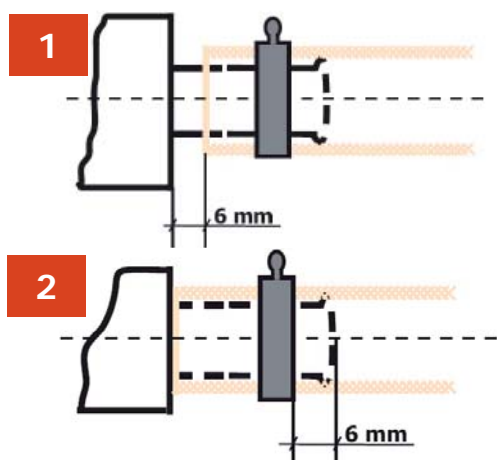

1) Boiler connection

2) Other connections



### Replacing the pipes

1) Use a suitable pair of pliers to remove the clamp (as shown in the picture)



2) Tighten the clamp as shown in the pictures

# CHAPTER 8

# NOTES

