

Service
Service
Service



Service Manual

Rev. 01 August. 2015

General Information

Description	Value
Housing material	Plastic
Size (w x h x d)	295mm x 325mm x 420mm
Weight	6.9 kg (data may vary depending on the model)
Power Cord length	0.8m -1.2m
Control panel	Front type
Cup size	Up to 95mm
Water tank	1000ml
Coffee bean hopper capacity	200g (Puro) 170g (Vapore)
Coffee grounds drawer capacity	8
Pump pressure	15 bar
Boiler	Stainless steel
Safety devices	Thermal fuse
Power rating	Inside of maintenance door
Nominal voltage	Inside of maintenance door

All parts of this document are the property of Saeco International Group.

All rights reserved. This document and all the information herein is provided without liability deriving from any errors or omissions. Furthermore, no part may be reproduced, used or collected, except where express authorisation has been provided in writing or through a contractual agreement.

Table of contents		Page
History (Modifications to service manual)		
1. Introduction		
1.1. Documentation required		1
1.2. Tools and resources		1
1.3. Material		1
1.4. Safety warnings		1
1.5. Service Policy		3
1.6.1. External machine parts (Puro)		4
1.6.2. External machine parts (Vapore)		5
1.6.3. Internal machine parts		6
2. Technical specifications		
2.1. Technical specifications		1
2.2. Machine parameters and performance		1
2.3. Specification for the measurement of the coffee products temperature		2
2.3.1. Specification for the measurement of the Milk products temperature.		3
2.4. Machine parameters and performance		5
3. User instructions		
3.1. Customer menu PHI 2000 Puro		1
3.2. Customer menu PHI 2000 Vapore		5
3.3. Operation, cleaning and maintenance		9
4. Operating logic		
4.1. Water circuit		1
4.2. Control ringnut and valve		3
4.3. Coffee cycle operating diagram		4
4.4. Single microswitch		5
4.5. Temperature sensor		5
4.6. Coffee grinder function		6
4.7. Low bean level detection, dose quantity adjustment, coffee grinder blocked		6
4.8. Dose self-learning (SAS)		7
4.9. Water filter		7

Table of contents		Page
History (Modifications to service manual)		
5. Troubleshooting		
5.1. Test Mode PHI 2000 Puro		1
5.2. Test Mode PHI 2000 Vapore		7
5.3. Steam out PHI 2000 Puro		13
5.4. Steam out PHI 2000 Vapore		14
6. Service and maintenance		
6.1. Repair Flow		1
7. Disassembly		
7.1. Outer Shell		1
7.2. KYB interface		2
7.3. The control knob and coffee keys		2
7.4. The boiler pin		3
7.5. Gearmotor		4
7.6. The boiler		5
7.7. The flow selector fauced		5
7.8. The pump and turbine		6
7.9. The coffee grinder		6
7.10. Grinder adjustment/assembly and disassembly		7
7.11. OETIKER clamps assembly and disassembly		8
8. Notes		
9. Water circuit diagram		
9.1. Water circuit diagram Puro		1
9.2. Water circuit diagram Vapore		2
10. Electrical diagram		
10.1. Electrical diagram PHI 2000 Puro/Vapore		1

MODIFICATIONS TO SERVICE MANUAL				
From Rev.	To Rev.	Chapter	Inserted	Modified
Rev.00	Rev01	01		Par. 1.4. Safety warnings
		02	Par. 2.4 Descaling cycle frequency	Par. 2.2.2 Specification for the measurement of the Milk products temperature.
		04	Par. 4.9. Water filter	
		06		Par. 6.1 Repair Flow

CHAPTER 1

INTRODUCTION

1.1 Documentation required

The following documentation is needed for repair procedures:

- Instruction booklet for specific model
- Technical documentation for specific model (diagrams, exploded view, symptom cure and service manual)

1.2 Tools and resources

As well as the standard equipment, the following is required:

Qty.	Description	Notes
1	Screwdriver	Torx T 10
1	Pliers for Oetiker clamps	
1	CC -A - Vdc tester	
1	Digital thermometer	Scale limit > 150°C
1	SSC (Saeco Service Center)	Programmer

1.3 Material

Description	Notes
Thermal paste	Heating element > 200°C
Descaler	Saeco Entkalker
Grease solvent	Personal preference
Silicone grease	Safe to use with food

1.4 Safety warnings

We recommend you consult the technical manual of the machine before performing any maintenance work.

Observe all applicable standards relating to the repair of electrical appliances.

Always disconnect the power plug from the mains before beginning repair work.

Always disconnect the power plug from the mains before beginning repair work.



Simply turning off the main machine power switch is not an adequate safety precaution. This domestic appliance is rated as insulation class I. On completion of the repair work, insulation and dielectric rigidity tests must be performed.



Disassembling the machine, the operator must pay attention to hot and under Pressure parts: boiler, pin-boiler, valves, dispensing, steam tube, brew unit, connections and pipes to avoid burns. Please refer to specific hydraulic circuit (Image1) to know the parts in detail.



The machine hydraulic circuit can reach maximum pressure of 16/18 bar. To operate in safety condition is recommended to perform the Steam Out procedure in order to remove the pressure and hot water inside the hydraulic circuit.

When the machine arrives at the Service Center in descaling mode interrupted, or making Descaling, be very careful not to come into contact with the Descaler. After the product has been repaired, it should function properly and has to meet the safety requirements and legal regulations as officially laid down at this moment

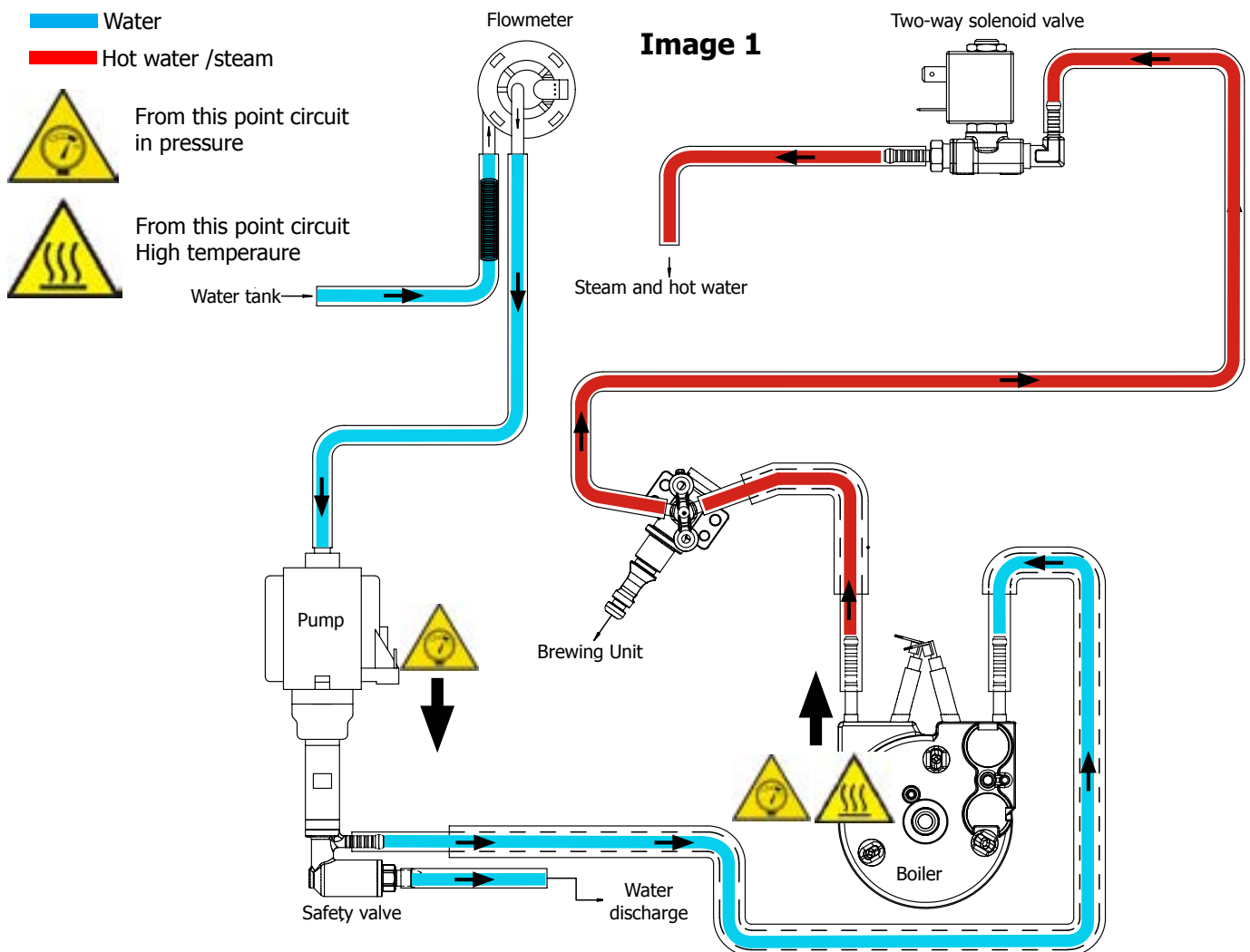

1.5 Service POLICY grid as used for coffee machines

For IN WARRANTY repairs is mandatory to use the single components (not the assembly) available in the exploded views of the coffee machines or of the specific components. If you find the information "SEE THE EXPLODED VIEW E....." in the assembly description field, it means that the single components of the assembly are available in the other pages of the exploded view. It's possible to use the assembly only if there is a specific Symptom Cure that include this possibility or when the single components are not available for the order.

List of principal assembly present in all our coffee machines

Components	Assembly use	Single components available
COFFEE GRINDER	<u>Only for OOW repairs</u>	YES , to consult the specific exploded-view of the machine or of the Coffee Grinder on website
BREWING UNIT	<u>Only for OOW repairs</u>	YES , to consult the specific exploded-view of the machine or of the Brewing unit on website
BOILER	<u>Only for OOW repairs</u>	YES , to consult the specific exploded-view of the machine on website
GEAR MOTOR	<u>Only for OOW repairs</u>	YES , to consult the specific exploded-view of the machine on website
FILTER HOLDER	<u>Only for OOW repairs</u>	YES , to consult the specific exploded-view of the machine on website
MILK CARAFE	<u>Only for OOW repairs</u>	YES , to consult the specific exploded-view of the machine on website
THERMAL CARAFE	<u>Only for OOW repairs</u>	YES , to consult the specific exploded-view of the Thermal Carafe on website
MILK ISLAND	<u>Only for OOW repairs</u>	YES , to consult the specific exploded-view of the Milk Island on website

1.6.1 External machine parts (Puro)

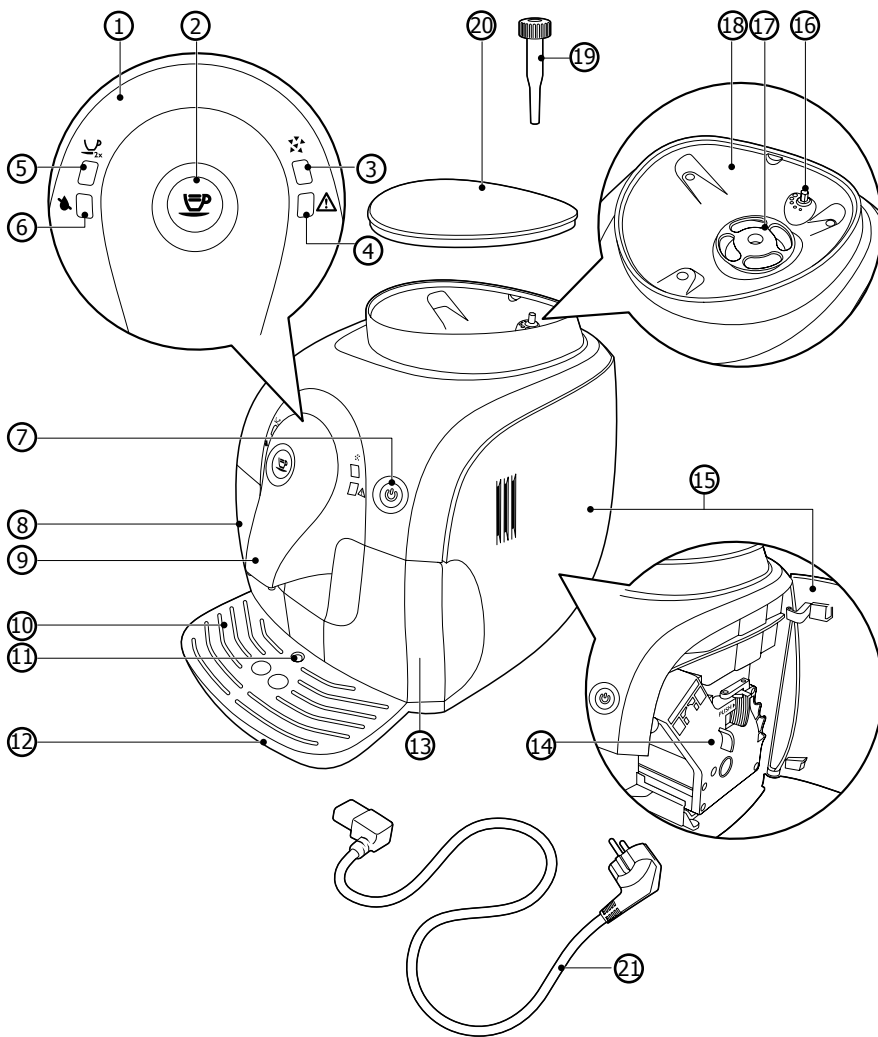

1	Control panel
2	Espresso button
3	Descaling light
4	Warning light
5	2-cup light
6	'Water tank empty' light
7	On/off button with light
8	Water tank
9	Coffee spout
10	Drip tray cover
11	'Drip tray full' indicator
12	Drip tray
13	Coffee grounds container
14	Brewing unit
15	Maintenance door
16	Grinding degree adjustment knob
17	Ceramic coffee grinder
18	Coffee bean container
19	Grinding degree adjustment tool
20	Lid of coffee bean container
21	Mains cord

1.6.2 External machine parts (Vapore)

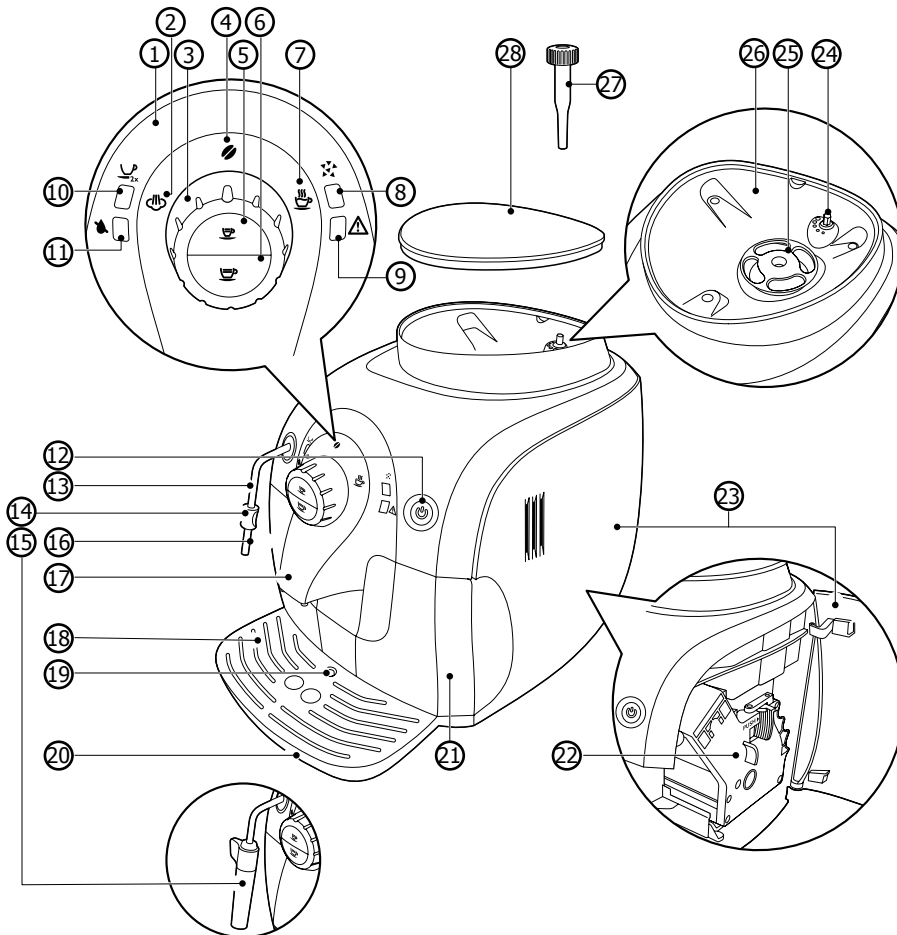

1	Control panel
2	Steam icon
3	Control dial
4	Coffee bean icon
5	Espresso button
6	Regular coffee button
7	Hot water icon
8	Descaling light
9	Warning light
10	2-cup light
11	'Water tank empty' light
12	On/off button with light
13	Hot water/steam wand
14	Protective handle
15	classic milk frother (specific types only)
16	Water tank
17	Coffee spout
18	Drip tray cover
19	'Drip tray full' indicator
20	Drip tray
21	Coffee grounds container
22	Brewing unit
23	Maintenance door
24	Grinding degree adjustment knob
25	Ceramic coffee grinder
26	Coffee bean container
27	Grinding degree adjustment tool
28	Lid of coffee bean container

1.6.3 Internal machine parts

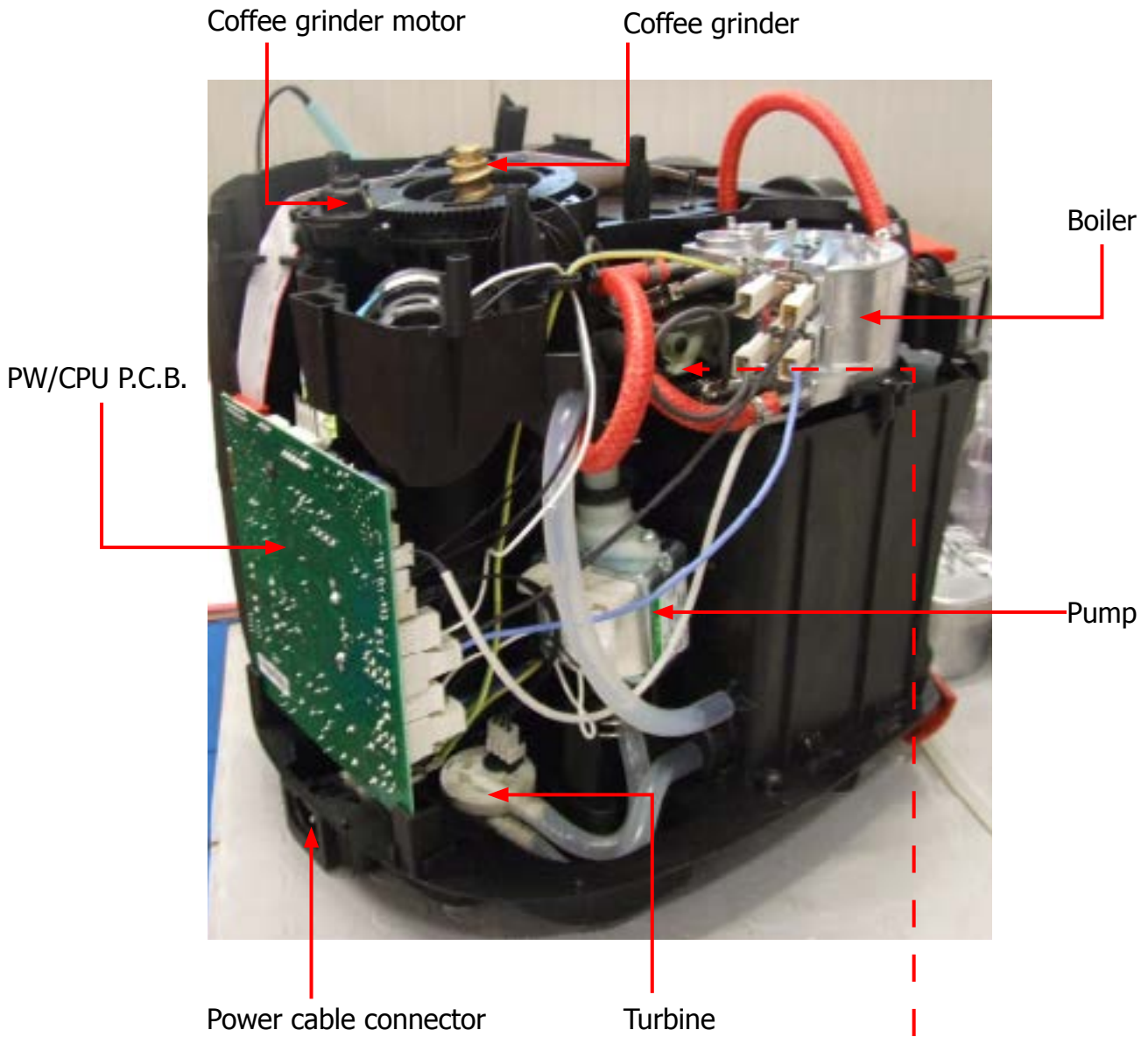

Valve



CHAPTER 2

TECHNICAL SPECIFICATIONS

2.1. Technical specifications

Power supply and output:	230 V~ 50/60 Hz 1500 W - 120 V~ 60 Hz 1500 W - 100 V~ 50/60 Hz 1300 W
Temperature monitoring:	Variable resistor sensor (NTC) - transmits the value to the electronic P.C.B.
Safety system:	2 manual reset or one-shot thermostats (175°C)
Coffee heat exchanger output: Stainless steel	(230/120 V~) 1300 W - (100 V~) 1100 W for coffee, hot water and steam dispensing
Gear motor:	33VC with 2 rotation directions; power supply 24VC
Pump:	Ulka with reciprocating piston and 100°C cutout 48 W, 230 V, 50 Hz, Type EP5 approx. 13-15 bar 120 V, 60 Hz 100 V, 50/60 Hz
Overpressure valve:	Opens at approx. 16-18 bar
Water filter:	In tank
Coffee grinder:	Direct current motor with flat ceramic grinders
Hot water/steam valve	Presblock
Automatic dosage	Dose adjustment controlled by the electronic system
Power consumption:	During the heating phase - approx. 5.6 A
Dimensions: W x H x D in mm:	295x325x420 (data may vary depending on the model)
Weight:	6.9 kg
Water tank capacity:	1.0 litres
Coffee container capacity	185 g coffee beans
Coffee dreg drawer capacity	08
Heat exchanger capacity:	Approx. 10 cc
Water circuit filling time:	Approx. 15 seconds for first filling cycle
Heating time:	Approx. 45 seconds
Dispensing temperature:	Approx. 84 ± 4°C
Grinding time:	Approx. 8-10 seconds

2.2. Machine parameters and performance

AMOUNT OF PRODUCT	Minimum amount (Puls.)	Default amount (Puls.)	Maximum amount (Puls.)	Programm. by the user	Programm. by Production/Service department
Espresso button	70	165	600	Yes	No
Regular coffee button	70	440	600	Yes	No
Pre-ground	No				
Hot water	Continues until the water supply has been exhausted (fill circuit status)				
Steam for frother	Continues until the water supply has been exhausted (fill circuit status)				

2.3. Specification for the measurement of the coffee products temperature.

The temperature is influenced by the flow from the dispenser and stratification of temperatures in the glass. In order to consider these phenomena and to introduce measures that allow comparisons in controlled conditions, below guidelines must be followed:

Conditions:

- a) Water temperature in tank: 23°C (+/-2°C).
- b) It must be used a plastic cup (see picture N°1).
- c) It must be used a thermocouple thermometer (e.g. type K - see picture N°2).
- d) The coffee machine is tested without any change of parameters or calibrations, which may affect the temperature of products, so the measurement of temperature must be done with machine in default factory setting.

Procedure:

1. The temperature must be measured in the cup, immediately after dispensing. Cup has to be placed on a non-metal surface using a thermocouple thermometer (Picture 1).
2. The temperature in the cup is measured by immersing the probe of the thermometer up to touch the bottom. The probe then must be moved in a circular motion for 5/6 rotations. At the of the rotations, stop in the center of the cup (Picture 2).
3. The highest temperature measured during the rotations is the value we are searching for, and that must be reported;
4. Test measurement: from end of dispensing to the end of rotations must be completed within 12 seconds.
5. the distance of the probe from the bottom of the glass is a function of the quantity of coffee dispensed: 10mm for 35gr - 17mm for 60gr - 35mm for 120gr and superior (Picture 3).

Limits of acceptability

The acceptance limits are divided by features and products and are the following:

Espresso Coffee Italy Q.ty 25/40 gr.

Temperature of 1st product 69°C ≤ 85°C
 Temperature of 2nd product 72°C ≤ 85°C

Coffee Q.ty 70/120 gr.

Temperature of 1st product 69°C ≤ 85°C
 Temperature of 2nd product 72°C ≤ 85°C

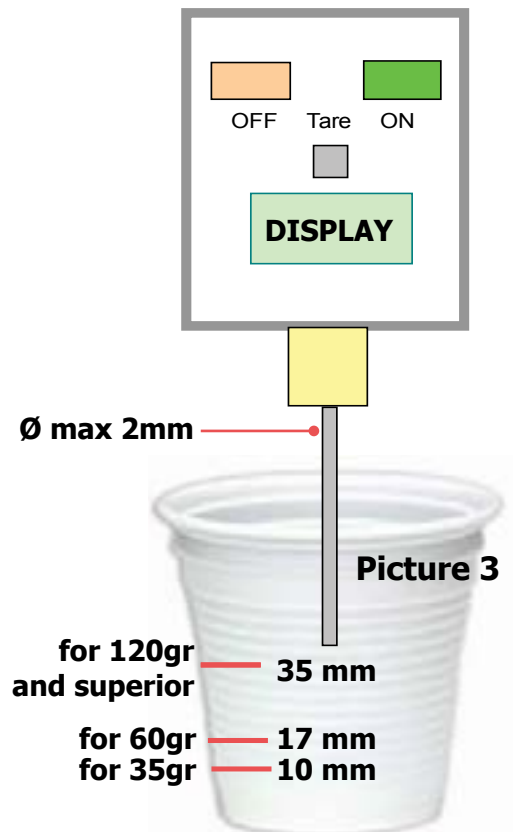

2.3.1. Specification for the measurement of the Milk products temperature.

Milk evaluation

To carry out the test, a partially skimmed UHT milk with a percentage of grease between 1.5-1.8% at a refrigerator temperature $T_{refr.}$ (between 4 to 10°C) must be used.

The milk product must be checked on a beaker of 250 ml of capability and with an inner diameter of 70mm, brewing 100gr of product.

Parameters to be respected:

The parameters to be respected are: milk temperature and height of the cream. Each of these parameters, however, must be evaluated depending on the type of system used for the production of hot milk.

Actually three types of devices are present on the appliances:

- Manual system (pannarello)
- Semi-Automatic system (cappuccinatore)
- Automatic system (carafe, Pinless wonder system, etc.)

Height of the milk cream in the beaker:

Manual system (pannarello) $\geq 15\text{mm}$ on 100gr. of brewed product

Semi-automatic system (cappuccinatore) $\geq 20\text{mm}$ on 100gr. of brewed product

Automatic system: carafe, cappuccinatore, Pinless wonder (New Royal, Energica Pure, Intelia EVO latte) $\geq 20\text{mm}$ on 100gr. of brewed product

How to measure the temperature of the milk.

1. The measurement is carried out in the beaker, immediately after the end of milk brew, positioned on a non-metallic surface, using a thermocouple thermometer (eg. Type K). Stop the preparation of mixed product: at the end of milk brewing, where "One Touch product" function is present.
2. The temperature is measured by immersing the probe of the thermometer, positioning the probe inside the beaker at about 10mm from the bottom of the container, then the probe moves in a circular motion for 3-5 turns, stopping at the end, at the center of the beaker. It detects the maximum temperature reached in a time of relief between 3 to 5 seconds. It is important the mixing of milk before the measurement at 10mm from the bottom of the beaker. If the mixing is correct, temperature, for a few fractions of a second, during the measurement should not oscillate.

How to measure the milk cream.

The temperature (T_{refr} or T_{amb}) of the milk doesn't affect as much the test result on measuring the milk cream; by convection is assumed to always use milk at refrigerator temperature T_{refr} .

Manual systems (Pannarello)

Pour 100cc. of milk at T_{refr} . in a beaker of 250 ml of capacity and with a inner diameter of 70 mm; with machine in steam mode:

1. Open the steam knob to discharge water circuit for 4 sec, then close the knob.
2. Place the beaker with the frother dipped in milk, open the steam knob to maximum and start the chronometer.
3. After about 30 to 60 seconds, close the knob and check the result on milk.

Semi-automatic systems (cappuccino)

Pours milk at T_{refr} . in a container ; with the machine in steam mode:

1. Open the steam knob to discharge water circuit for 4 sec. then close the knob.
2. Insert the silicone tube in the milk container, placing a beaker of 250 ml capacity and with an inner diameter of 70 mm under the cappuccino maker and open the steam knob.
3. After having provided 100gr. of product, close the knob and check the result obtained on milk.
Note: The same applies to machines which have a steam key on the user interface and a solenoid valve in place of the steam tap.

Automatic: Carafe, Cappuccino Pinless wonder (New Royal, Energica Pure, Intelia EVO Latte), etc..

After setting the machine to delivery of 100gr. of product:

1. Launch the "hot milk" function.
2. Collect the product in a beaker with a 250ml of capacity and with an inner diameter of 70 mm, and verify the result obtained on milk. Carry out the test using milk at a T_{refr} .

In case the machine allows modify of the emulsion through the menu, use the machine with the emulsion set to the default value.

Related to the above testing procedure derives the following table of acceptability:

Manual, Semi-Automatic and Automatic's Milk System	
Grams of Product	Minimum Height of the milk cream
≥ 130	≥ 30mm
120	≥ 25mm
110	≥ 22mm
100	≥ 20mm
90	≥ 16mm
80	≥ 13mm
70	≥ 11mm

NB: To verify more accurately the height of the cream, a practical expedient dictated by experience is to add to the product just delivered a small amount of coffee. The addition of coffee immediately put in evidence the surface of separation between liquid and cream.

2.4. Machine parameters and performance

PRODUCT QUANTITY	Minimum amount (Puls.)	Default amount (Puls.)	Maximum amount (Puls.)	Programm. by the user	Programm. by Production / Service
Espresso button	70	165	600	Yes	No
Regular coffee button	70	440	600	Yes	No
Hot water	Continues until the water supply has been exhausted (capacitive sensor)				
Steam for frother	Continues until the water supply has been exhausted (capacitive sensor)				

RINSE	Initial rinse	Final rinse
When performed	It is activated when the machine is in Power-Off for more than 15 minutes	When the machine is switched off electronically, manually or automatically after 30minutes, if at least one coffee has been dispensed, before switching off
No. of pulses	150	80
Stopping option	Yes, by pressing any key	Yes, by pressing any key
User disable option	No	No
Production/Service department disable option	No	No
No. of pulses user adjustment option	No	No
No. of pulses Production/Service department adjustment option	No	No
Pulse range (Min. - Max.)	No	No

Descaling cycle frequency			
Hardness	Water hardness	Without water filter	With water filter
1	Soft (up to 7°dH)	240 litres (480,000 pulses)	480 litres (960,000 pulses)
2	Medium (7° - 14°dH)	120 litres (240,000 pulses)	240 litres (480,000 pulses)
3	Hard (15° - 21°dH)	60 litres (120,000 pulses)	120 litres (240,000 pulses)
4	Very hard (over 21°dH)	30 litres (60,000 pulses)	60 litres (120,000 pulses)

The default water hardness level is 4. Each litre of water corresponds to approximately 2,000 pulses.

In the machines where is not possible change the water hardness the default hardness level is 3.

CHAPTER 3

BRIEF INSTRUCTIONS

3.1. Customer menu PHI 2000 PURO

Control Panel

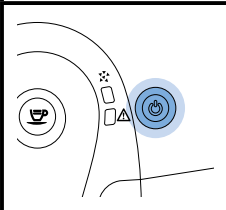
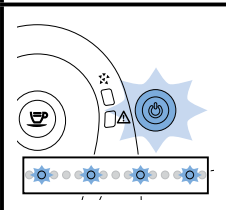
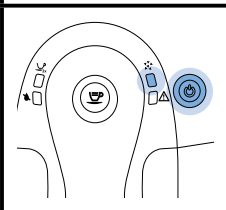
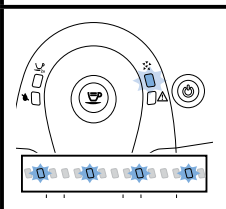
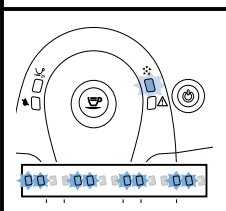
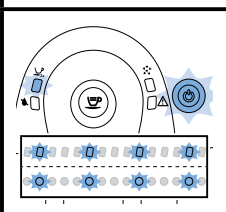

Indications	Description
	<p>The on/off button lights up continuously. The machine is ready to brew coffee.</p>
	<p>The on/off button flashes slowly. The machine is warming up or performing a procedure.</p>
	<p>The descaling light and the on/off button light up continuously. You have to descale the machine.</p>
	<p>The descaling light flashes slowly. The machine is in the descaling cycle.</p>
	<p>The descaling light flashes twice continuously. The machine is performing the rinsing cycle of the descaling procedure.</p>
	<p>The 2-cup light and the on/off button flash slowly. The machine is programming the amount of coffee to brew.</p>

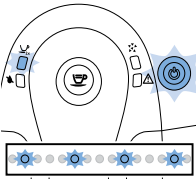
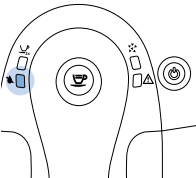
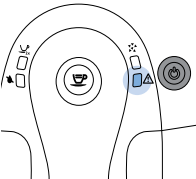
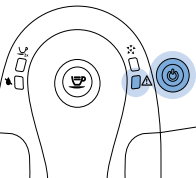
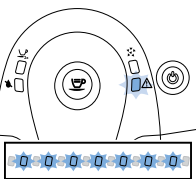
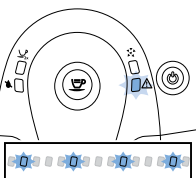
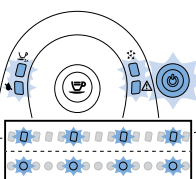
Indications	Description
	<p>The 2-cup light lights up continuously and the on/off button flashes slowly. The machine is brewing two cups of coffee.</p>
	<p>The 'water tank empty' light lights up continuously. The water level is low. Fill the water tank with fresh water up to the MAX indication.</p>
	<p>The warning light lights up continuously and the on/off button goes out. The coffee grounds container is full. Empty the coffee grounds container while the machine is on. Make sure that the warning light flashes before you reinsert the coffee grounds container.</p>
	<p>The warning light and the on/off button light up continuously. The coffee bean container is empty. Refill the coffee bean container. The warning light goes out after brewing coffee.</p>
	<p>The warning light flashes quickly. There is no water in the internal circuit.</p>
	<p>The warning light flashes slowly. The brewing unit is not correctly inserted, the coffee grounds container is not inserted or the maintenance door is open. Make sure the brewing unit and coffee grounds container are inserted correctly and the maintenance door is closed. If you cannot take out the brewing unit or place it back, switch the machine off and on again.</p>
	<p>The lights flash slowly and simultaneously. The machine is out of order. Switch off the machine for 30 seconds, then switch it back on. Try this two or three times. If the machine does not reset, contact the Philips Consumer Care Centre in your country.</p>

Problem	Solution
The machine does not work.	Make sure the small plug is inserted into the socket. Plug in and switch on the machine.
	Make sure that the voltage indicated on the machine corresponds to the local mains voltage.
The machine is stuck in the descaling procedure.	Press the on/off button. You can restart the descaling procedure.
The coffee is not hot enough.	Preheat the cups. Use thin-walled cups.
The espresso does not have enough crema.	Use a different type of coffee beans or adjust the ceramic coffee grinder.
The brewing unit cannot be removed.	Remove the coffee grounds container before you open the maintenance door. If you still cannot remove the brewing unit follow the next steps. Reinsert the coffee grounds container, close the maintenance door, switch on the machine. The machine prepares for use. Switch off the machine and try to remove the brewing unit again.
The brewing unit cannot be placed back.	Make sure that the lever is in contact with the base of the brewing unit. Also make sure that the hook of the brewing unit is in the correct position.
	If you still cannot place the brewing unit back. Reinsert the coffee grounds container and leave the brewing unit out. Close the maintenance door, switch on the machine. The machine prepares for use. Switch off the machine and try to place back the brewing unit again.
The machine grinds the coffee beans but no coffee comes out (see note).	Clean the coffee exit duct and set the grinder to a coarser setting. Clean the brewing unit.
	Fill the water tank with water.
	Clean the coffee spout.
The coffee is too weak (see note).	Adjust the ceramic coffee grinder to a finer setting.
	Brew a few cups of coffee to let the machine adjust itself to the new grinding settings.
	Use a different type of coffee beans.

Problem	Solution
Water ends up in the drip tray.	This is normal. To guarantee the perfect cup of coffee, the machine uses water to rinse the internal circuit and brewing unit. Some of the water flows through the internal system directly into the drip tray. Empty the drip tray regularly.
The machine seems to be leaking.	The drip tray is full and overflowed during brewing or the descaling procedure.
	Check if the water tank is leaking.
	The brewing unit or the drains behind or under the brewing unit may be blocked. Rinse the brewing unit with lukewarm water and clean the upper filter carefully. Also clean the inside of the machine with a soft, damp cloth.
Coffee is brewed slowly (see note).	The coffee grind is too fine. Change coffee blend or adjust the grind setting.
	The brewing unit is dirty. Clean the brewing unit.
	The water circuit of the machine has become blocked by scale. Descale the machine.

3.2. Customer menu PHI 2000 VAPORE

Control Panel

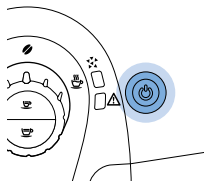
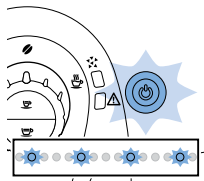
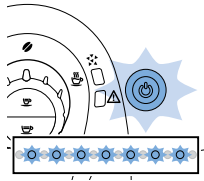
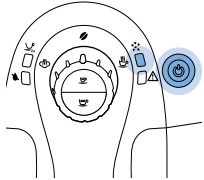
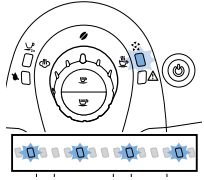
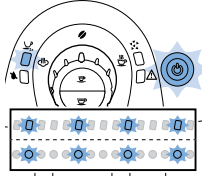

Indications	Description
	<p>The on/off button lights up continuously. The machine is ready for use.</p>
	<p>The on/off button flashes slowly. The machine is warming up or performing a procedure.</p>
	<p>The on/off button flashes quickly. The machine is overheated. Brew a cup of hot water to cool down the machine.</p>
	<p>The descaling light and the on/off button light up continuously. You have to descale the machine.</p>
	<p>The descaling light flashes slowly. The machine is descaling.</p>
	<p>The 2-cup light and the on/off button flash slowly. The machine is programming the amount of coffee to brew. The 2-cup light lights up continuously and the on/off button flashes slowly. The machine is brewing two cups of coffee.</p>

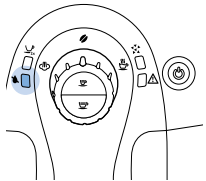
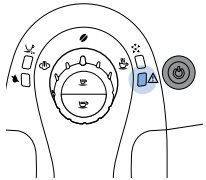
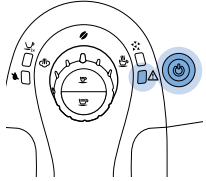
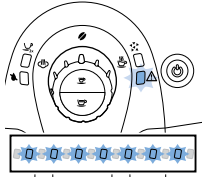
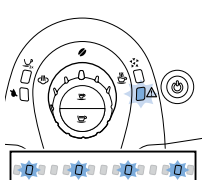
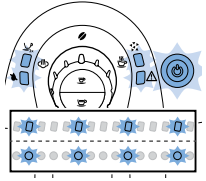
Indications	Description
	<p>The 'water tank empty' light lights up continuously. The water level is low. Fill the water tank with fresh water up to the MAX indication.</p>
	<p>The warning light lights up continuously and the on/off button goes out. The coffee grounds container is full. Empty the coffee grounds container while the machine is on. Make sure that the warning light flashes before you reinsert the coffee grounds container.</p>
	<p>The warning light and the on/off button light up continuously. The coffee bean container is empty. Refill the coffee bean container.</p>
	<p>The warning light flashes quickly. There is no water in the internal circuit. Turn the control dial to the hot water icon and let hot water come out of the machine until the water flows continuously.</p>
	<p>The warning light flashes slowly. The brewing unit is not correctly inserted, the coffee grounds container is not inserted, the maintenance door is open or the control dial is not in the correct position. Make sure the brewing unit and coffee grounds container are inserted correctly, the maintenance door is closed and the control dial is in the correct position. If you cannot take out the brewing unit or place it back, switch the machine off and on again.</p>
	<p>The lights flash slowly and simultaneously. The machine is out of order. Switch off the machine for 30 seconds, then switch it back on. Try this two or three times. If the machine does not reset, contact the Philips Consumer Care Centre in your country.</p>

Problem	Solution
The machine does not work.	Make sure the small plug is inserted into the socket. Plug in and switch on the machine.
	Make sure that the voltage indicated on the machine corresponds to the local mains voltage.
The machine is stuck in the descaling procedure.	Press the on/off button. You can restart the descaling procedure.
The coffee is not hot enough.	Preheat the cups by rinsing them with hot water. Use thin-walled cups.
The coffee temperature decreases over time.	Descale the machine.
No hot water or steam comes out of the hot water/steam wand.	Check if the hole of the hot water/steam wand is clogged. If so, clean the hole.
	The classic milk frother may be dirty. Clean the classic milk frother.
The espresso does not have enough crema.	Use a different type of coffee beans or adjust the ceramic coffee grinder.
The machine does not heat up fast enough and little coffee comes out.	Descale the machine.
The brewing unit cannot be removed.	Remove the coffee grounds container before you open the maintenance door. If you still cannot remove the brewing unit follow the next steps. Reinsert the coffee grounds container, close the maintenance door, switch on the machine. The machine prepares for use. Switch off the machine and try to remove the brewing unit again.
The brewing unit cannot be placed back.	Make sure that the lever is in contact with the base of the brewing unit. Also make sure that the hook of the brewing unit is in the correct position.
	If you still cannot place the brewing unit back. Reinsert the coffee grounds container and leave the brewing unit out. Close the maintenance door, switch on the machine. The machine prepares for use. Switch off the machine and try to place back the brewing unit again.
The machine grinds the coffee beans but no coffee comes out.	Clean the coffee exit duct and set the grinder to a coarser setting. Clean the brewing unit.
	Fill the water tank with water.
	Clean the coffee spout.

Problem	Solution
The coffee is too weak.	Adjust the ceramic coffee grinder to a finer setting.
	Brew a few cups of coffee to let the machine adjust itself to the new grinding settings.
	Use a different type of coffee beans.
Water ends up in the drip tray.	This is normal. To guarantee the perfect cup of coffee, the machine uses water to rinse the internal circuit and brewing unit. Some of the water flows through the internal system directly into the drip tray. Empty the drip tray regularly.
The machine seems to be leaking.	The drip tray is full and overflowed during brewing or the descaling procedure.
	Check if the water tank is leaking.
	The brewing unit or the drains behind or under the brewing unit may be blocked. Rinse the brewing unit with lukewarm water and clean the upper filter carefully. Also clean the inside of the machine with a soft, damp cloth.
There is not enough coffee in my cup.	Air may be present in the internal circuit. Rinse the internal circuit of the machine by turning the control dial to the hot water icon and letting some hot water flow out of the machine.
	Clean the brewing unit.

3.3. Operation, cleaning and maintenance

Operating the machine		
1	Fill the water tank	
2	Fill the coffee bean container	
3	Switch on the appliance	
4	Press the coffee key	Press once for one coffee; twice for two coffees.

CLEANING AND TECHNICAL SERVICING		
A	Empty the coffee dreg drawer	When indicated
B	Empty the drip tray	As necessary or when indicated
C	Clean the water tank	Weekly
D	Clean the coffee bean container	As necessary
E	Clean the casing	As necessary
F	Clean the brewing unit	Every time the coffee bean container is filled, or weekly, or
	Lubricate the brewing unit	Once a month or every 500 dispensing procedures
	Clean the unit housing	Weekly
H	Perform descaling	Every 1 or 2 months, or when you notice a reduction in the water flow rate

Descaling cycle frequency			
Hardness	Water hardness	Without limescale filter	With limescale filter
1	Soft water (up to 7°dH)	Approx. every 3 months / 120 litres	Approx. every 6 months / 240 litres
2	Medium water (7° - 14°dH)	Approx. every 2 months / 90 litres	Approx. every 4 months / 180 litres
3	Hard water (15° - 21°dH)	Approx. every 6 weeks or 60 litres	Approx. every 3 months / 120 litres
4	Very hard water (over 21°dH)	Approx. every 4 weeks or 30 litres	Approx. every 6 weeks or 60 litres

CHAPTER 4

OPERATING LOGIC

4.1. Water circuit

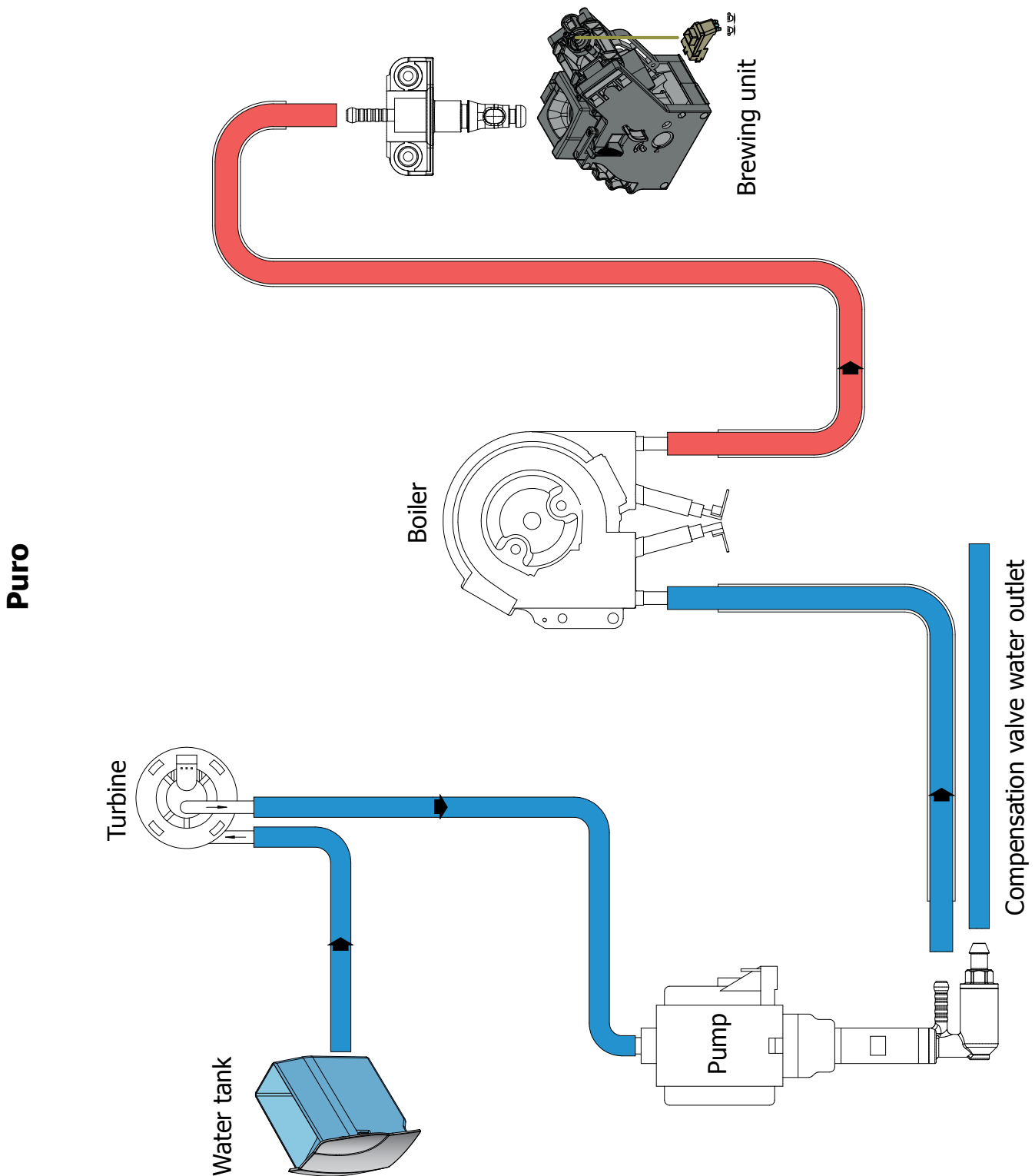

- Traditional water system
- Turbine – Amount of coffee dispensed into the cup
- Reciprocating piston type pump (13 - 15 bar)
- Compensation valve (opening pressure 16 - 18 bar)
- Presblok valve – select coffee – hot water - steam

Vapore

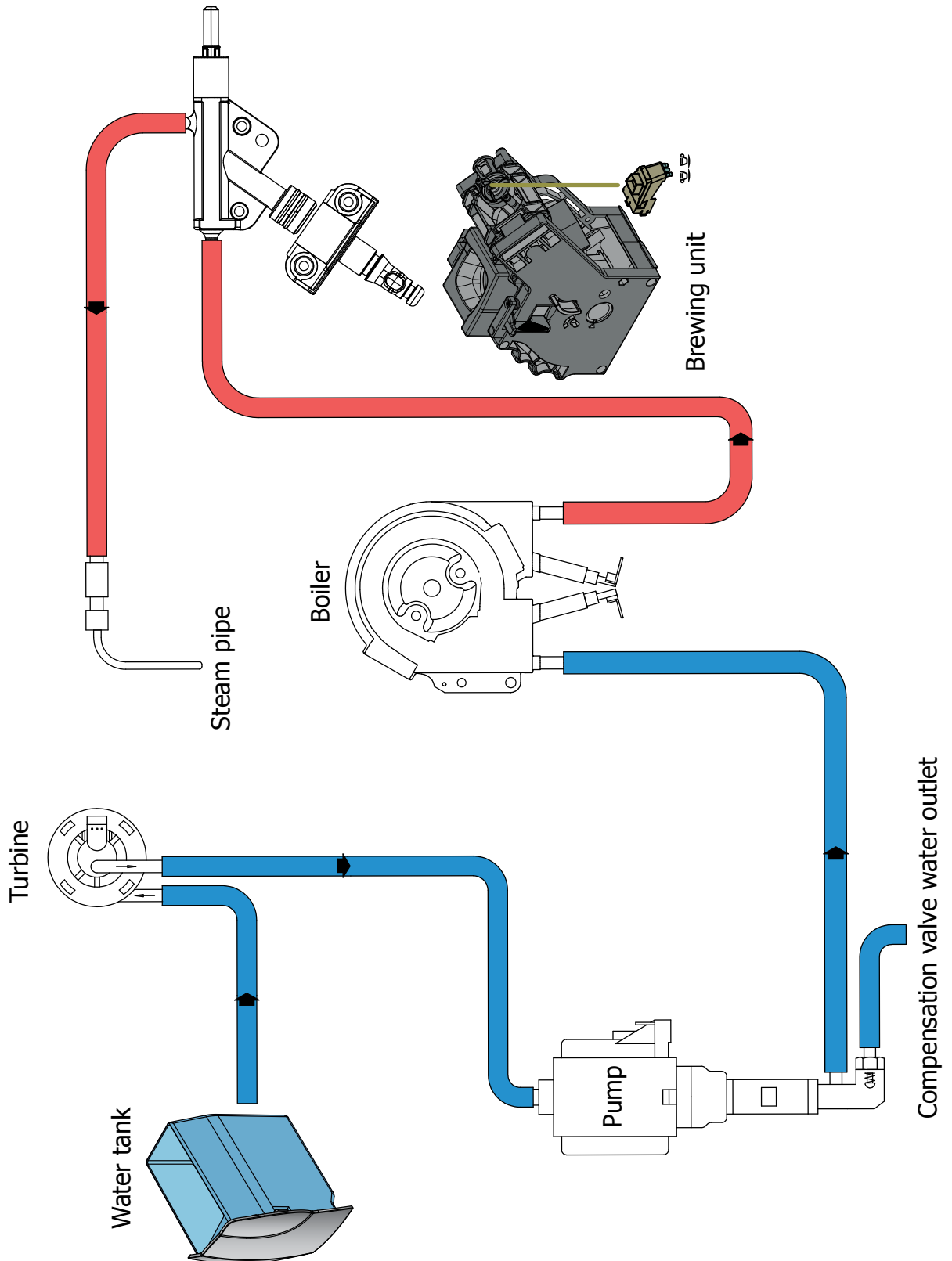

- Traditional water system
- Turbine – Amount of coffee dispensed into the cup
- Reciprocating piston type pump (13 - 15 bar)
- Compensation valve (opening pressure 16 - 18 bar)
- Presblok valve – select coffee – hot water - steam

4.2. Control ringnut and valve

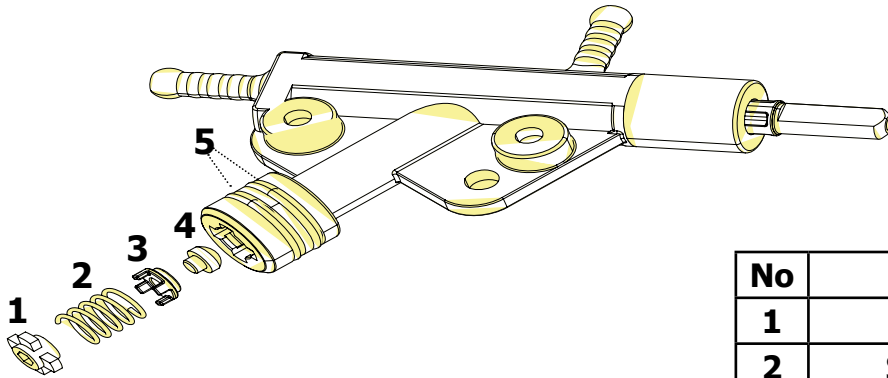

No	DESCRIPTION
1	Mushroom valve cap
2	Spring for mushroom valve
3	Mushroom valve support
4	Mushroom valve
5	Sealing OR

When dispensing coffee the mushroom valve opens at 4 bar +/- 0.5

Manual opening when dispensing water

Manual opening when dispensing steam

4.3. Coffee cycle operating diagram

Main switch ON	START		STOP
Time			
Coffee grinder			Pulses (Dosage)
Heating	approx. 45 secs.		
Pump			Pump activity (turbine pulses) depending on the product quantity selected *
Brewing unit gear motor			
Status	Heating	Ready	Coffee cycle

Notes: * Only with Pre-brewing



Single microswitch gear motor

Switching on

When the machine is switched on, the gear motor repositions itself as follows:

- It acts on microswitch 1 (see following. section)
- The gear motor changes its rotation direction and moves upwards again by approx. 1-2 mm
- The boiler begins to heat water for approx. 45 seconds. It absorbs all the available heating power in order to reach the optimal temperature. The temperature will then remain at a constant level.

Coffee cycle

1. The coffee grinder starts the grinding process (controlled by pulses generated by a sensor)
2. The gear motor (brewing unit) moves to the dispensing position
3. Preliminary dispensing phase (short pump activity, short pause)
4. Product dispensing (the pump operation period is defined by the amount of product dispensed)
5. The gear motor moves to its home position (the dregs are expelled automatically)

4.4. Single microswitch

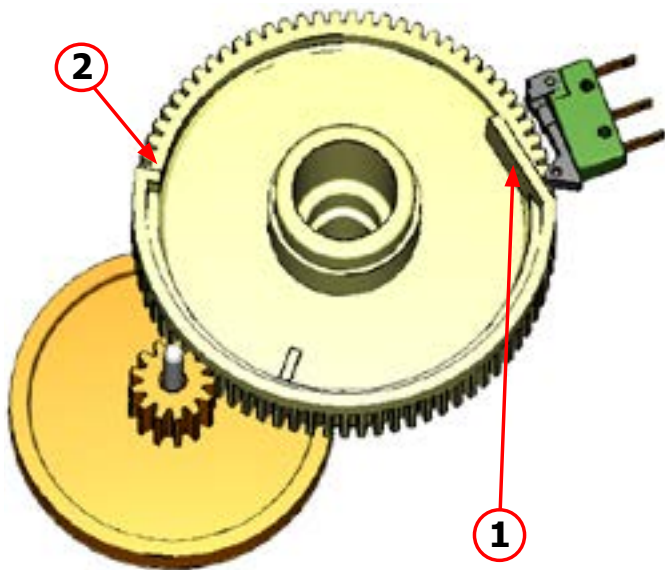

The gear motor is powered by a direct current motor that engages with the smaller double toothed wheel using a worm screw. The unit is mounted on the axle of the large gear wheel and when a coffee is requested, it moves from the home position to the dispensing position, and then back to the home position again.

- Home position: 1
- Dispensing position: 2

4.5. Temperature sensor (adjustment)

Temperature sensor

An NTC is used as a temperature sensor; in the event of overheating this reduces boiler element power consumption.

The electronic system detects the current boiler temperature from the drop in voltage and adjusts it accordingly.

Resistor values: see table

Temp. (°C)	R nom (kΩ)	ΔR (+/- %)
20	61,465	8,6
50	17,599	5,9
75	7,214	4,1
80	6,121	3,7
85	5,213	3,4
90	4,459	3,1
100	3,3	2,5
125	1,653	3,9
150	0,893	5,1

4.6. Coffee grinder function

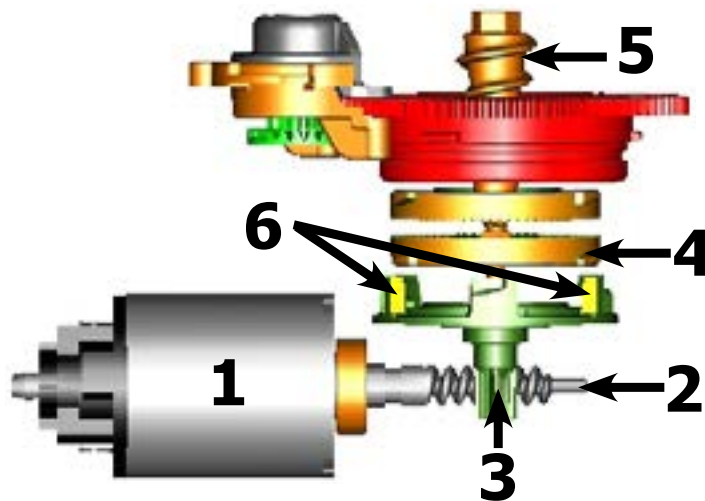

Ceramic coffee grinder

The coffee grinder is driven by a direct current motor (1) using a worm screw helicoidal wheel transmission (2).

The worm screw (2) drives a plastic gear wheel (3), which turns the lower grinder (4) and the increment pin (5)

There are two magnets (6) in the gear wheel; at every rotation these transmit two pulses to a Hall sensor, which in turn transmits them to the electronic system.

4.7. Low bean level detection, dose quantity adjustment, coffee grinder blocked

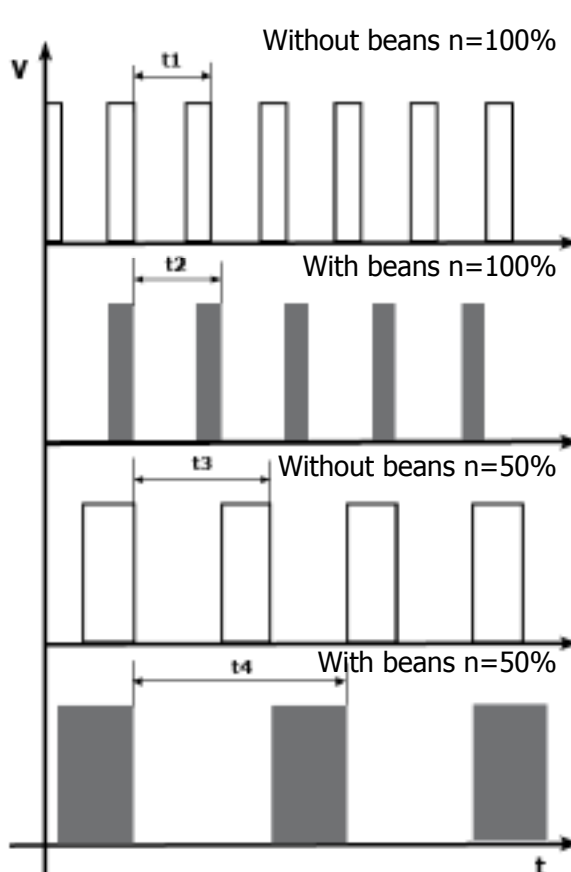

No coffee

A low coffee bean level is detected by the Hall sensor, after variations in the pulse frequency (with or without coffee).

If there are no coffee beans (operation while empty), the number of rotations – and therefore the number of pulses – will be greater

t1 = No coffee indication

If, however, there are coffee beans, the number of rotations will be lower due to the force created by the grinding

t2 = no indication

t3 and t4 = this measurement is performed at the end of each grinding process

Dose quantity adjustment

The dose quantity is adjusted in accordance with the pulses detected (number of rotations proportional to the selected flavour – mild, medium or strong)

Coffee grinder blockage

If the coffee grinder becomes blocked for any reason, pulses will no longer be transmitted to the electronic system and the grinder will come to a stop

4.8 Dose self-learning (SAS)

The aim of this function is to automatically regulate the average dose of ground coffee (SELF-LEARNING); this takes place with an algorithm based on the following values and setting by the user:

1. Number of coffee grinder pulses during the grinding cycle.
2. Max. average value of the power consumed by the gear motor during the coffee brewing cycle.
3. Aroma selected by the user.

The algorithm compares the maximum average value of the power consumed by the gear motor with the value listed in the table for the selected aroma, in order to calculate the new grinding pulse value for the next coffee produced.

If the power consumption value is less than the minimum current value, the grinding pulses will be increased by 2.

If the power consumption value is greater than the maximum current value, the grinding pulses will be decreased by 4.

If the power consumption value falls within the "over-torque" interval, the product will be dispensed and the grinding pulses will be decreased by 10.

If the power consumption value falls within the "abort cycle" interval, the dreg will be expelled and the grinding pulses will be decreased by 10.

If the "pre-ground" flavour is selected by the user, no modification will be made.

This guarantees that, regardless of the coffee type used, the grinding level setting and the wear on the grinders, the ground coffee dose always remains constant.

SETTING	DOSE ADJUSTMENT (NUMBER OF GRINDER IMPULSES) TO APPLY TO MED AROMA				
	+2	0	-4	-10	-10 and CYCLE ABORTED
Strong	MAX_CURRENT_mA <350mA	<=350mA MAX_CURRENT_mA <=500mA	MAX_CURRENT_mA >500mA	MAX_CURRENT_mA >800mA	MAX_CURRENT_mA >1000mA

Caution: In the case of excessive dosage, powder may be expelled into the dreg drawer. This is not a fault, but can occur during preliminary operation or after a service.

4.9. Water filter

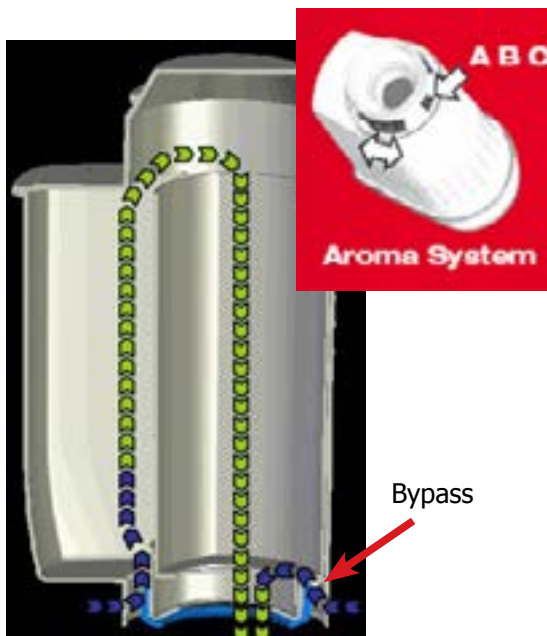

Function:

- Reduced limescale deposits which take longer to form.
- Improved water quality.
- Improved taste due to the ideal water hardness.

Life span / descaling performance:

- - 10 ° dH
- 60 litres
- 2 months

To achieve the best possible operating mode consistency over the total life span, the water is channelled using a 3-stage bypass (A, B, C) depending on the degree of hardness. See small image.

CHAPTER 5

SERVICE MODE

5.1 Test Mode PHI 2000 Puro

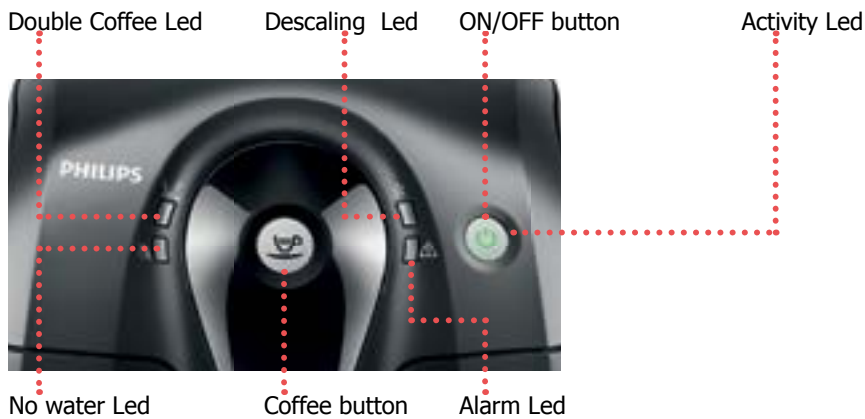

This document describes the test mode of XS PH Puro Machine. This application is used in order to test the machine in its mechanics and electronic components.

The machine enters in test mode by pushing the COFFEE button

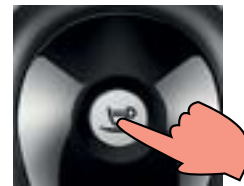

and then connecting the machine to the plug

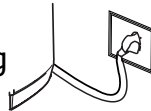

As long as the COFFEE button is pressing the machine shows the Led Calc-Clean, Led Activity, Led Alarm, Led NoWater, Led DoubleCoffee flashing with rotation.

When the COFFEE button is release the machine pass to the first level of the test.

There are 5 different levels, in each level the coffee-machine can execute different commands:

Level 1: The machine can test the input signal:

- a) Microswitch present of the brewing unit
- b) Microswitch present of the dregdrawer
- c) Microswitch door closed/opened
- d) Button Coffee
- e) Button ON-OFF
- f) Capacitive sensor water

Level 2: The machine can test the loads in low voltage:

- a) Brewing unit (24V DC)

Level 3: The machine can test the Pump in high voltage:

- a) Pump (120-230V AC)

Level 4: The machine can test the Heater load in high voltage:

- a) Heater (120-230V AC)

Level 5: The machine can test the Grinder load in high voltage:

- a) Grinder (320V DC)

The user can switch the level by pressing the Button ON/OFF:

As long as the button ON-OFF is pressing the machine show the level of the test:

- 1. Level 1 :** Led DoubleCoffee ON (G), Led Calc-Clean OFF (O), Led Activity OFF (G), Led Alarm OFF (R), Led Water OFF (R)
- 2. Level 2 :** Led DoubleCoffee ON (G), Led Calc-Clean ON (O), Led Activity OFF (G), Led Alarm OFF (R), Led Water OFF (R)
- 3. Level 3 :** Led DoubleCoffee ON (G), Led Calc-Clean ON (O), Led Activity ON (G), Led Alarm OFF (R), Led Water OFF (R)
- 4. Level 4 :** Led DoubleCoffee ON (G), Led Calc-Clean ON (O), Led Activity ON (G), Led Alarm ON (R), Led Water OFF (R)
- 5. Level 5 :** Led DoubleCoffee ON (G), Led Calc-Clean ON (O), Led Activity ON (G), Led Alarm ON (R), Led Water ON (R)

Legend:

- (O)** = Orange
- (G)** = Green
- (R)** = Red

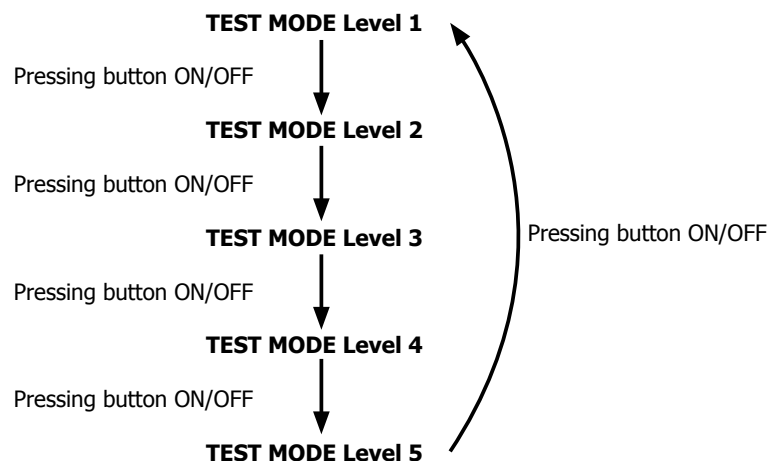

At the start up all loads are turned off. The software allow to have only one load active at the same time.

Level 1 (Input, Led)

Start condition: NO BU, NO drag drawer, No tank, door open.	LED INDICATION				
	Led Activity	Led Descaling	Led Alarm	Led NoWater	Led Double Coffee
	OFF	OFF	OFF	ON	OFF
Action by user	LED INDICATION				
	Led Activity	Led Descaling	Led Alarm	Led NoWater	Led Double Coffee
Insert a full water tank					
Switch on the red led NoWater	OFF	OFF	OFF	OFF	OFF
ERROR: The led NoWater remain on , check the capacitive sensor and the wiring (JP23)	OFF	OFF	OFF	ON	OFF
Insert the BU					
The red led alarm blinks one time	OFF	OFF	One blink	N.A.	OFF
ERROR: The led alarm remains off , check the BU microswitch and the wiring (JP14)	OFF	OFF	OFF	N.A.	OFF
Insert the drag drawer					
The red led alarm blinks one time	OFF	OFF	One blink	N.A.	OFF
ERROR: The led alarm remains off , check the microswitch on the drag drawer and the wiring (JP16)	OFF	OFF	OFF	N.A.	OFF
Close the door					
The red led alarm blinks one time. When all micro (3) are closed the green led double coffee remains on.	OFF	OFF	One blink	N.A.	ON
ERROR: The led double coffee remains off, check the microswitch on the door and the wiring (JP16)	OFF	OFF	OFF	N.A.	OFF
Press the coffee button					
Switch on the green led activity	ON	OFF	N.A.	N.A.	N.A.
ERROR: The led activity remain off , check the interface board and the flat cable (JP21)	OFF	OFF	N.A.	N.A.	N.A.
Finish condition with tank, BU, drag drawer and door closed	LED INDICATION				
	Led Activity	Led Descaling	Led Alarm	Led NoWater	Led Double Coffee
	OFF	OFF	OFF	OFF	ON

Level 2 (Brewing unit)

Start condition: BU, drag drawer and door closed.	LED INDICATION				
	Led Activity	Led Descaling	Led Alarm	Led NoWater	Led Double Coffee
	OFF	OFF	OFF	OFF	OFF
Action by user	LED INDICATION				
	Led Activity	Led Descaling	Led Alarm	Led NoWater	Led Double Coffee
Press the coffee button to move the BU to work					
When the BU reaches the work position and the current is OK ⇒ the green activity temp is switched on.	ON	OFF	OFF	OFF	OFF
ERROR: the BU moves to Home; check the polarity of the motor	N.A.	OFF	OFF	OFF	OFF
ERROR: led activity remains OFF; Check the work microswitch (is broken), the BU motor (is blocked) and the wiring (JP16).	OFF	OFF	OFF	OFF	OFF
ERROR: led alarm Switch ON, check the BU; * with BU the absorbed current is much more 300mA * without BU the absorbed current is much more 200mA	N.A.	OFF	ON	OFF	OFF
Press the coffee button to move the BU to home					
When the BU reaches the home position and the current is OK⇒ the green led activity is switched on.	ON	OFF	OFF	OFF	OFF
ERROR: the BU moves to Work; check the polarity of the motor	N.A.	OFF	OFF	OFF	OFF
ERROR: led activity remains OFF; Check the work microswitch (is broken), the BU motor (is blocked) and the wiring (JP16).	OFF	OFF	OFF	OFF	OFF
ERROR: led alarm Switch ON, check the BU; * with BU the absorbed current is much more 300mA * without BU the absorbed current is much more 200mA	N.A.	OFF	ON	OFF	OFF
Finish condition	LED INDICATION				
	Led Activity	Led Descaling	Led Alarm	Led NoWater	Led Double Coffee
	N.A.	N.A.	OFF	N.A.	N.A.

Level 3 (Pump)

Start condition:	LED INDICATION				
	Led Activity	Led Descaling	Led Alarm	Led NoWater	Led Double Coffee
	OFF	OFF	OFF	OFF	OFF
Action by user	LED INDICATION				
	Led Activity	Led Descaling	Led Alarm	Led NoWater	Led Double Coffee
Press the coffee button to switch on the Pump					
The led activity flashing	Flashing	OFF	OFF	OFF	OFF
ERROR: the led activity remains OFF and the led alarm switch ON; check the pump, the flowmeter, the wiring from the flowmeter to the CPU/POWER board (JP5) and the wiring from the pump to the CPU/POWER board (JP24)	OFF	OFF	OFF	OFF	OFF
Finish condition	LED INDICATION				
	Led Activity	Led Descaling	Led Alarm	Led NoWater	Led Double Coffee
	N.A.	N.A.	OFF	N.A.	N.A.

Level 4 (Heater)

Start condition:	LED INDICATION				
	Led Activity	Led Descaling	Led Alarm	Led NoWater	Led Double Coffee
	OFF	OFF	OFF	OFF	OFF
Action by user	LED INDICATION				
	Led Activity	Led Descaling	Led Alarm	Led NoWater	Led Double Coffee
Check the temperature					
The red led General Alarm remains OFF	OFF	OFF	OFF	OFF	OFF
ERROR: The temperature sensor is shorted or opened, the led GenAlarm switch ON; check the wiring from the heater to the CPU/POWER board (JP17-3) and the other wiring	OFF	OFF	ON	OFF	OFF

Press the coffee button to switch on the Heater					
The user checks that the absorbed current is OK	N.A.	N.A.	N.A.	N.A.	N.A.
ERROR: the absorbed current is KO; check the wiring from the heater to the CPU/POWER board (JP17-3) and the other wiring	N.A.	N.A.	N.A.	N.A.	N.A.
Finish condition	LED INDICATION				
	Led Activity	Led Descaling	Led Alarm	Led NoWater	Led Double Coffee
	N.A.	N.A.	OFF	N.A.	N.A.

Level 5 (Grinder)

Start condition:	LED INDICATION				
	Led Activity	Led Descaling	Led Alarm	Led NoWater	Led Double Coffee
	OFF	OFF	OFF	OFF	OFF
Action by user	LED INDICATION				
	Led Activity	Led Descaling	Led Alarm	Led NoWater	Led Double Coffee
Press the coffee button to switch on the Grinder					
The led activity flashing	Flashing	OFF	OFF	OFF	OFF
ERROR: : the led activity remains OFF and the led alarm switch ON; check the hall sensor board in the Grinder, the Grinder, the wiring from the hall sensor board to the CPU/POWER board (JP2) and the wiring from the Grinder to the CPU/POWER board (JP8)	OFF	OFF	ON	OFF	OFF
Finish condition	LED INDICATION				
	Led Activity	Led Descaling	Led Alarm	Led NoWater	Led Double Coffee
	N.A.	N.A.	OFF	N.A.	N.A.

5.2 Test Mode PHI 2000 Vapore

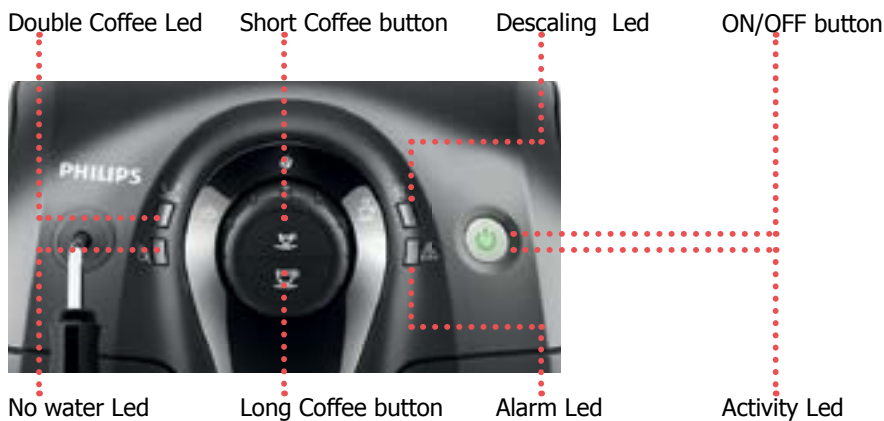

This document describes the test mode of XS PH Vapore machine. This application is used in order to test the machine in its mechanics and electronic components.

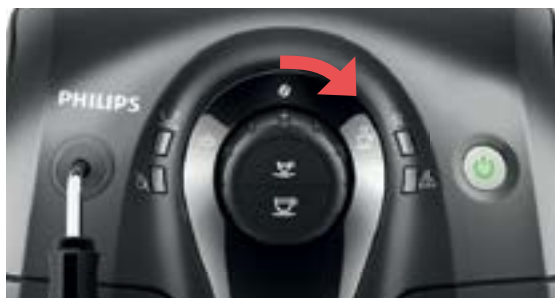

Water Position

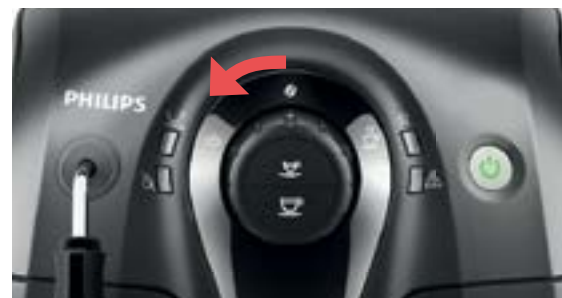

Water Position

The machine enters in test mode by moving the knob in the Water position then pushing the COFFEE short button



and then connecting the machine to the plug

As long as the COFFEE short button is pressing the machine shows the Led Calc-Clean, Led Activity, Led Alarm, Led NoWater, Led DoubleCoffee, flashing with rotation.

When the COFFEE short button is release the machine pass to the first level of the test.

There are 4 different level, in each level the coffee-machine can execute different commands:

Level 1: The machine can test the input signal:

- Microswitch present of the brewing unit
- Microswitch present of the dregdrawer
- Microswitch door closed/opened
- Button Short Coffee
- Button Long Coffee
- Button ON-OFF
- Photosensor Water
- Photosensor Steam (only in Middle-TOP model)

Level 2: The machine can test the loads in low voltage:

- Brewing unit (24V DC)

Level 3: The machine can test the Pump in high voltage:

- Pump (120-230V AC)

Level 4: The machine can test the Heater load in high voltage:

- Heater (120-230V AC)

Level 5: The machine can test the Grinder load in high voltage:

- Grinder (320V DC)

The user can switch the level by pressing the Button ON/OFF:

As long as the button ON-OFF is pressing the machine show the level of the test:

- 1. Level 1 :** Led DoubleCoffee ON (G), Led Calc-Clean OFF (O), Led Activity OFF (G), Led Alarm OFF (R), Led Water OFF (R)
- 2. Level 2 :** Led DoubleCoffee ON (G), Led Calc-Clean ON (O), Led Activity OFF (G), Led Alarm OFF (R), Led Water OFF (R)
- 3. Level 3 :** Led DoubleCoffee ON (G), Led Calc-Clean ON (O), Led Activity ON (G), Led Alarm OFF (R), Led Water OFF (R)
- 4. Level 4 :** Led DoubleCoffee ON (G), Led Calc-Clean ON (O), Led Activity ON (G), Led Alarm ON (R), Led Water OFF (R)
- 5. Level 5 :** Led DoubleCoffee ON (G), Led Calc-Clean ON (O), Led Activity ON (G), Led Alarm ON (R), Led Water ON (R)

Legend:

- (O)** = Orange
- (G)** = Green
- (R)** = Red

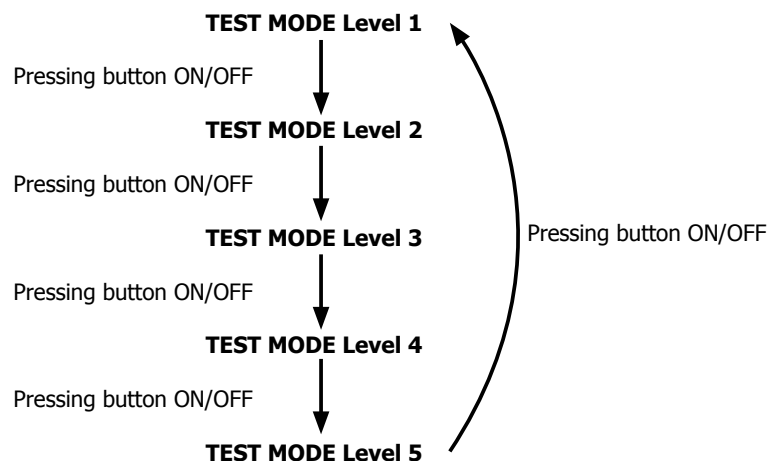

At the start up all loads are turned off. The software allow to have only one load active at the same time.

Level 1 (Input, Led)

Start condition: NO BU, NO drag drawer, No tank, door open.	LED INDICATION				
	Led Activity	Led Descaling	Led Alarm	Led NoWater	Led Double Coffee
	OFF	OFF	OFF	ON	OFF
Action by user	LED INDICATION				
	Led Activity	Led Descaling	Led Alarm	Led NoWater	Led Double Coffee
Insert a full water tank					
Switch on the red led NoWater	OFF	OFF	OFF	OFF	OFF
ERROR: The led NoWater remain on , check the capacitive sensor and the wiring (JP23)	OFF	OFF	OFF	ON	OFF
Insert the BU					
The red led alarm blinks one time	OFF	OFF	One blink	N.A.	OFF
ERROR: The led alarm remains off , check the BU microswitch and the wiring (JP14)	OFF	OFF	OFF	N.A.	OFF
Insert the drag drawer					
The red led alarm blinks one time	OFF	OFF	One blink	N.A.	OFF
ERROR: The led alarm remains off , check the microswitch on the drag drawer and the wiring (JP16)	OFF	OFF	OFF	N.A.	OFF
Close the door					
The red led alarm blinks one time. When all micro (3) are closed the green led double coffee remains on.	OFF	OFF	One blink	N.A.	ON
ERROR: The led double coffee remains off, check the microswitch on the door and the wiring (JP16)	OFF	OFF	OFF	N.A.	OFF
Press the coffee short button					
Switch on the activity led	ON	OFF	N.A.	N.A.	N.A.
ERROR: The led activity remain off , check the interface board and the flat cable (JP21)	OFF	OFF	N.A.	N.A.	N.A.
Press the coffee long button					
Switch on the activity led	ON	OFF	N.A.	N.A.	N.A.
ERROR: The led activity remain off , check the interface board and the flat cable (JP21)	OFF	OFF	N.A.	N.A.	N.A.

Action by user	LED INDICATION				
	Led Activity	Led Descaling	Led Alarm	Led NoWater	Led Double Coffee
Move the knob in the water position					
Switch on the activity led	ON	OFF	N.A.	N.A.	N.A.
ERROR: The led activity remain off , check the interface board and the flat cable (JP21)	OFF	OFF	N.A.	N.A.	N.A.
Move the knob in the steam position					
Switch on the activity led temp	ON	OFF	N.A.	N.A.	N.A.
ERROR: The led activity remain off , check the interface board and the flat cable (JP21)	OFF	OFF	N.A.	N.A.	N.A.
Finish condition with tank, BU, drag drawer and door closed. Knob in the central position	LED INDICATION				
	Led Activity	Led Descaling	Led Alarm	Led NoWater	Led Double Coffee
	OFF	OFF	OFF	OFF	ON

Level 2 (Brewing unit)

Start condition: BU, drag drawer and door closed. Knob in the central position	LED INDICATION				
	Led Activity	Led Descaling	Led Alarm	Led NoWater	Led Double Coffee
	OFF	OFF	OFF	OFF	OFF
Action by user	LED INDICATION				
	Led Activity	Led Descaling	Led Alarm	Led NoWater	Led Double Coffee
Press the coffee button to move the BU to work					
When the BU reaches the work position and the current is OK ⇒ the green led activity is switched on.	ON	OFF	OFF	OFF	OFF
ERROR: the BU moves to Home; check the polarity of the motor	N.A.	OFF	OFF	OFF	OFF
ERROR: led activity remains OFF; Check the work microswitch (is broken), the BU motor (is blocked) and the wiring (JP16).	OFF	OFF	OFF	OFF	OFF
ERROR: led alarm Switch ON, check the BU; * with BU the absorbed current is much more 300mA * without BU the absorbed current is much more 200mA	N.A.	OFF	ON	OFF	OFF

Press the long button to move the BU to home					
When the BU reaches the home position and the current is OK ⇒ the green led activity is switched on.	ON	OFF	OFF	OFF	OFF
ERROR: the BU moves to Work; check the polarity of the motor	N.A.	OFF	OFF	OFF	OFF
ERROR: led activity remains OFF; Check the work microswitch (is broken), the BU motor (is blocked) and the wiring (JP16).	OFF	OFF	OFF	OFF	OFF
ERROR: led alarm Switch ON, check the BU; * with BU the absorbed current is much more 300mA * without BU the absorbed current is much more 200mA	N.A.	OFF	ON	OFF	OFF
Finish condition	LED INDICATION				
	Led Activity	Led Descaling	Led Alarm	Led NoWater	Led Double Coffee
	N.A.	N.A.	OFF	N.A.	N.A.

Level 3 (Pump)

Start condition:	LED INDICATION				
	Led Activity	Led Descaling	Led Alarm	Led NoWater	Led Double Coffee
	OFF	OFF	OFF	OFF	OFF
Action by user	LED INDICATION				
	Led Activity	Led Descaling	Led Alarm	Led NoWater	Led Double Coffee
Press the coffee button to switch on the Pump					
The led activity flashing	Flashing	OFF	OFF	OFF	OFF
ERROR: the led activity remains OFF and the led alarm switch ON; check the pump, the flowmeter, the wiring from the flowmeter to the CPU/POWER board (JP5) and the wiring from the pump to the CPU/POWER board (JP24)	OFF	OFF	OFF	OFF	OFF
Finish condition	LED INDICATION				
	Led Activity	Led Descaling	Led Alarm	Led NoWater	Led Double Coffee
	N.A.	N.A.	OFF	N.A.	N.A.

Level 4 (Heater)

Start condition:	LED INDICATION				
	Led Activity	Led Descaling	Led Alarm	Led NoWater	Led Double Coffee
	OFF	OFF	OFF	OFF	OFF
Action by user	LED INDICATION				
	Led Activity	Led Descaling	Led Alarm	Led NoWater	Led Double Coffee
Check the temperature					
The red led General Alarm remains OFF	OFF	OFF	OFF	OFF	OFF
ERROR: The temperature sensor is shorted or opened, the led GenAlarm switch ON; check the wiring from the heater to the CPU/POWER board (JP17-3) and the other wiring	OFF	OFF	ON	OFF	OFF
Press the coffee button to switch on the Heater					
The user checkers that the absorbed current is OK	N.A.	N.A.	N.A.	N.A.	N.A.
ERROR: the absorbed current is KO; check the wiring from the heater to the CPU/POWER board (JP17-3) and the other wiring	N.A.	N.A.	N.A.	N.A.	N.A.
Finish condition	LED INDICATION				
	Led Activity	Led Descaling	Led Alarm	Led NoWater	Led Double Coffee
	N.A.	N.A.	OFF	N.A.	N.A.

Level 5 (Grinder)

Start condition:	LED INDICATION				
	Led Activity	Led Descaling	Led Alarm	Led NoWater	Led Double Coffee
	OFF	OFF	OFF	OFF	OFF
Action by user	LED INDICATION				
	Led Activity	Led Descaling	Led Alarm	Led NoWater	Led Double Coffee
Press the coffee button to switch on the Grinder					
The led activity flashing	Flashing	OFF	OFF	OFF	OFF
ERROR: the led activity remains OFF and the led alarm switch ON; check the hall sensor board in the Grinder, the wiring from the hall sensor board to the CPU/POWER board (JP2) and the wiring from the Grinder to the CPU/POWER board (JP8)	OFF	OFF	ON	OFF	OFF
Finish condition	LED INDICATION				
	Led Activity	Led Descaling	Led Alarm	Led NoWater	Led Double Coffee
	N.A.	N.A.	OFF	N.A.	N.A.

5.3 Steam Out PHI 2000 PURO

This document describes the procedure of SteamOut in PHI 2000 Puro machine. This application is used in order to empty the heater.

500mm length in the silicon tube Ø 5x10



Insert the BLACK WATER INLET SLEEVE BREW UNIT assy (cod. 20000440 12NC 996530009825) in the silicon tube as in the Picture. (silicon tube cod. JS01.022)

In TEST MODE brew 250/500cc of water to cool down the boiler temperature and discharge the inner pressure.

Start the machine in SteamOut mode by pushing the COFFEE button and the ON-OFF button, and then connecting the machine to the plug.



As long as the buttons are pressed the machine shows all LEDS ON: Led Activity, Led Double Coffee, Led Alarm, Led NO_Water, Led CalcClean.

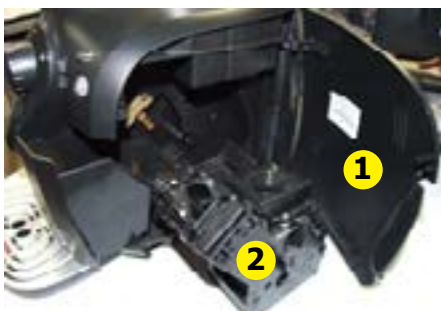

- 1) Open the service door
- 2) Extract the Brew-unit



- 3) Insert the BLACK WATER INLET SLEEVE BREW UNIT assembly, in the boiler pin

Warning:
Insert the silicone tube into a container because steam is released



Stimulate Micro door

Insert the coffee ground drawer

When the buttons are released the machine shows Led Calc Clean flashing.

Press coffee button to start the steam-out process.

When the steam out procedure is completed the "double coffee" Led lights up and the "Calc Clean" Led switch OFF.

5.4 Steam Out PHI 2000 VAPORE

This document describes the procedure of SteamOut in PHI 2000 Vapore machine. This application is used in order to empty the heater.

The machine enters in SteamOut mode by moving the knob in the water position



then pushing the COFFEE LONG button



and then connecting the machine to the plug.



As long as the COFFEE LONG button is pressing the machine shows all LEDS ON: Led Activity, Led Double Coffee, Led Alarm, Led NO_Water, Led CalcClean.

When the COFFEE LONG button is release the machine starts the Steam Out: Led CalcClean flashing. During this phase if the knob is moving in the central position the steam out procedure will be interrupted and the red led "General Alarm" will be switched On, in order to continue the steam out procedure move back the knob in the water position.

When the steam out procedure is completed the Led Double Coffee switch on and the Led CalcClean switch OFF.

Now is possible to switch off the machine or repeat the procedure moving the knob in the central position and after moving again the knob in the water position.

CHAPTER 6

SERVICING AND MAINTENANCE

6.1. Repair Flow

Proces stap	Saeco no.	Action
Intake	1	Visual inspection (transport damage) take care for pictures
	2	Check Type/serialnumber
		Log all available accessory
Diagnosis	3	Check product for consumer complaint (NFF contact consumer)
	4	Opening machine
	5	Visual inspection check for loosen parts, leaking etc..
	6	Operational tests
Repair		Run Diagnostic to get error codes and relevant set statistics (Saeco Service Center SSC)
	7	Repairing the faults encountered
	8	"Checking any modifications (view Symptom Cure, new software, etc.) Refer Annex tabs per family"
	9	Service activities in accordance with the operating schedule
		Check/Replace Waterfilter (the small filter, not the Britta filter)
		Check/Replace Water tank lip seal
		Check/Replace Boiler pin O-ring
		Clean/align Coffee grinder (Vacuum cleaner / brush)
		Descale the water Circuit
		Check/Replace Hot water/steam valve
	10	Internal check / cleaning
		Check/Clean/Grease Brewing unit
	11	Operational test while the appliance is open
		Check Hoses, attachments and Oetiker clamps
	Check Pump for operation & noise	
	Check Gear motor for operation & noise	
	Check for leakage	
12	Assembly	
13	Final inspection test	
14	Steam out before shipping out, if temperature is below 0° to prevent any damaged due to frozen water	
Inspection		
visual		Do cabinet parts fit well together
		Check for damages
Power check		Will the set switch on
Accessoires		Do the accessories match with the intake
Consumer complaint		Check the product for the consumer complaint
Coffee		
Dispense		Make 2 * coffee. Are both amounts equal
		Make e 2 cups at the same time. Are the volumes equal

Noise		Is the sound normal
Crema		Blow on the coffee. Does the crema come back together
		Is the crema colour correct (Hazelnut)
Temperature		Is the coffee temperature within spec
Grinder		Is the grinder noise normal
Steam		
Steam		Does the steam work
Hot Water		Does the hot water work
Milk		(if applicable)
Cappuchino		Does the cappuccinatore produce good froth
Leakage		
Leakage	14	Did the product leak during the testing
	15	Draining the circuit (in winter)
Cleaning		Clean water reservoir, bean reservoir, brew chamber and conveyor
	16	Clean and dry brew unit, coffee bin and drip tray.
		Lubricating the brewing unit with suitable grease
		External cleaning
Safety check		
		Earth leakage, Isolation test, resistor of earth wire grounding, as requested in certain country's (VDE, ISO)
visueel		Check the mains cord for damages
Packing		
	18	Packing
		Check completeness (accessories) according income log
	19	Neatly pack the product
Documentation		NFF letter
		Descaling instruction with changed procedure (S/C)
		Other instructions according S/C
Repair report		Is there an answer to ALL consumer questions/complaints (see complaint)
		add set statistic and give, if needed clear instruction towards consumer
		Is it indicated which documents are added
		Are there tips how to prevent issues

CHAPTER 7

DISASSEMBLY

7.1. Outer shell



Remove the dreg drawer, water tank, mushroom finger protection device on the coffee container lid and coffee container, then loosen the screws shown.

The USA type is inserted a grid Protective hand to replace the mushroom finger protection



Slide out the steam hose protection, lift the cover at the rear by pressing down gently on the cooling vents to help detach the anchoring tabs, then pull it away from the steam hose, taking care not to scratch it. (Only for Vapore)

Disassembling the Top cover



Remove the dreg drawer, water tank, mushroom finger protection device on the coffee container lid, then loosen the screws shown.

Disassembling the side cover



Loosen the screws shown and slide out the side cover; be careful of the protrusions **(A)** on the base.

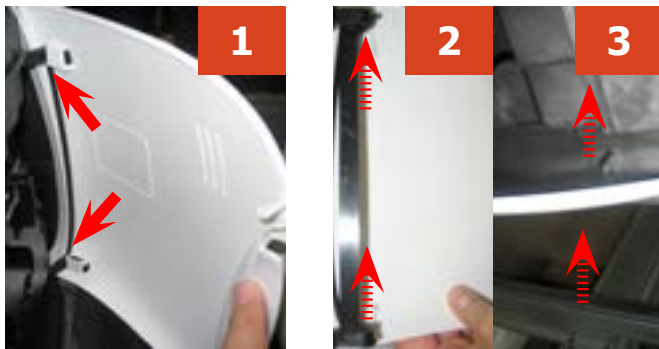

Disassembling the hatch

- 1) Detach the hatch by pressing the fastenings.
- 2) Lift the fastenings shown.
- 3) Slot for pins.

7.2. KYB interface



Remove the RHS and LHS light guide.



Loosen the screws shown, detach the dispenser, then remove the circlip and gear as illustrated in the photograph.



Slide out the control keypad.



Remove the flat cable shown and slide out the P.C.B.



For PHI 2000 Puro: loosen the screws shown and remove the flat cable

7.3. The control knob and coffee keys



To remove the coffee keys from the control keypad, detach them from the anchoring device on the back of it and take them out.



To remove the knob, simply slide it out of its position.

PHI 2000 Puro



To remove the coffee keys from the control keypad, detach them from the anchoring device on the back of it and take them out.

Disassembling the power P.C.B.



1

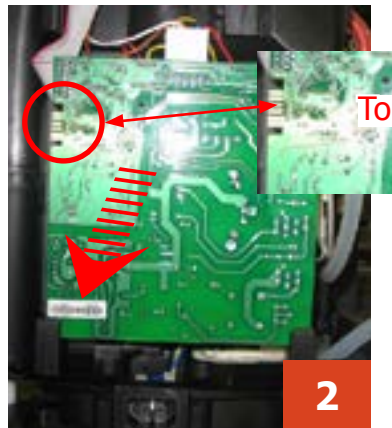

2

To reprogram the P.C.B. connect the S.S.C

1) Loosen the screw shown and remove the P.C.B. protection.

2) Slide out the P.C.B., removing all connections.

7.4. The boiler pin

Boiler pin (Vapore)



Loosen the screws shown and remove the boiler pin.

Boiler pin (Puro)

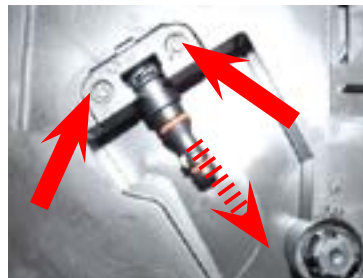

Loosen the screw and remove the boiler pin.



Remove the OETIKER clamp and pull out the silicon tube

7.5. Gearmotor



1) Loosen the screws holding the boiler pin in place, remove it and loosen the other screws shown

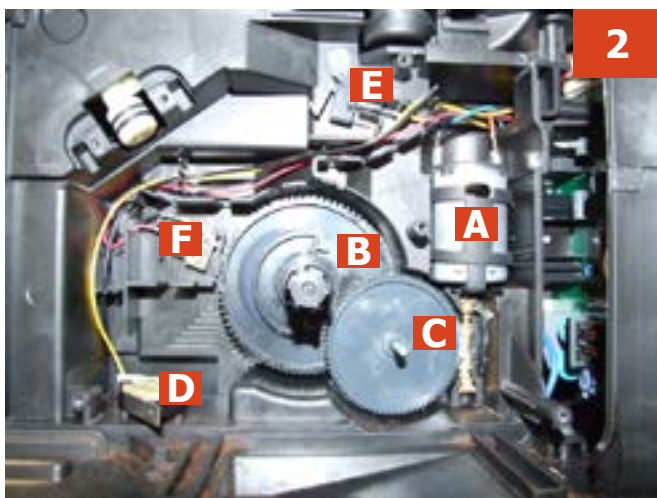

2) The following are located inside the compartment protected by the casing:

- Brew drive (A) with gears (B) and (C) for transmission and timing of the dispensing head.
- Grounds drawer present microswitch (D).
- Brewing unit present microswitch (E).
- Microswitch (F) detecting brewing unit home and work positions.
- Remove the gear (C) that meshes with the motor transmission shaft
- Remove the large gear (B)
- Remove the motor (A), complete with transmission shaft

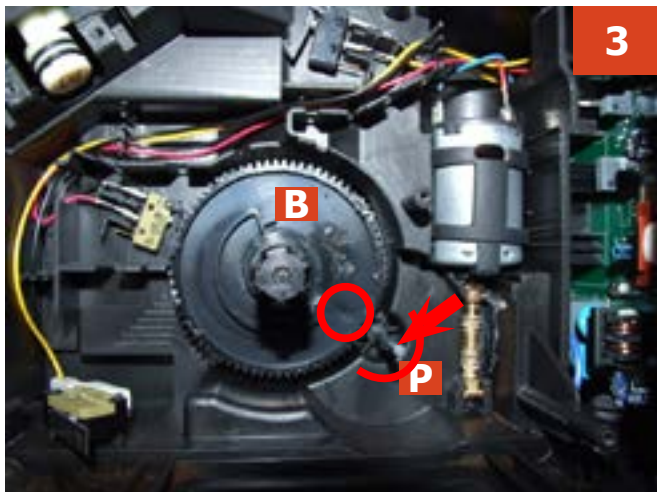

3) Replace the gear (B), making sure that the imprint of the arrow is aligned with the opening containing the pin (P)



4) When replacing the motor and the transmission shaft, make sure the bearings (L) are in the right position.

Grease the shaft thoroughly and evenly

7.6. The boiler



1) Loosen the screws shown.

2) Loosen the screw and remove the plastic support.

7.7. The flow selector faucet

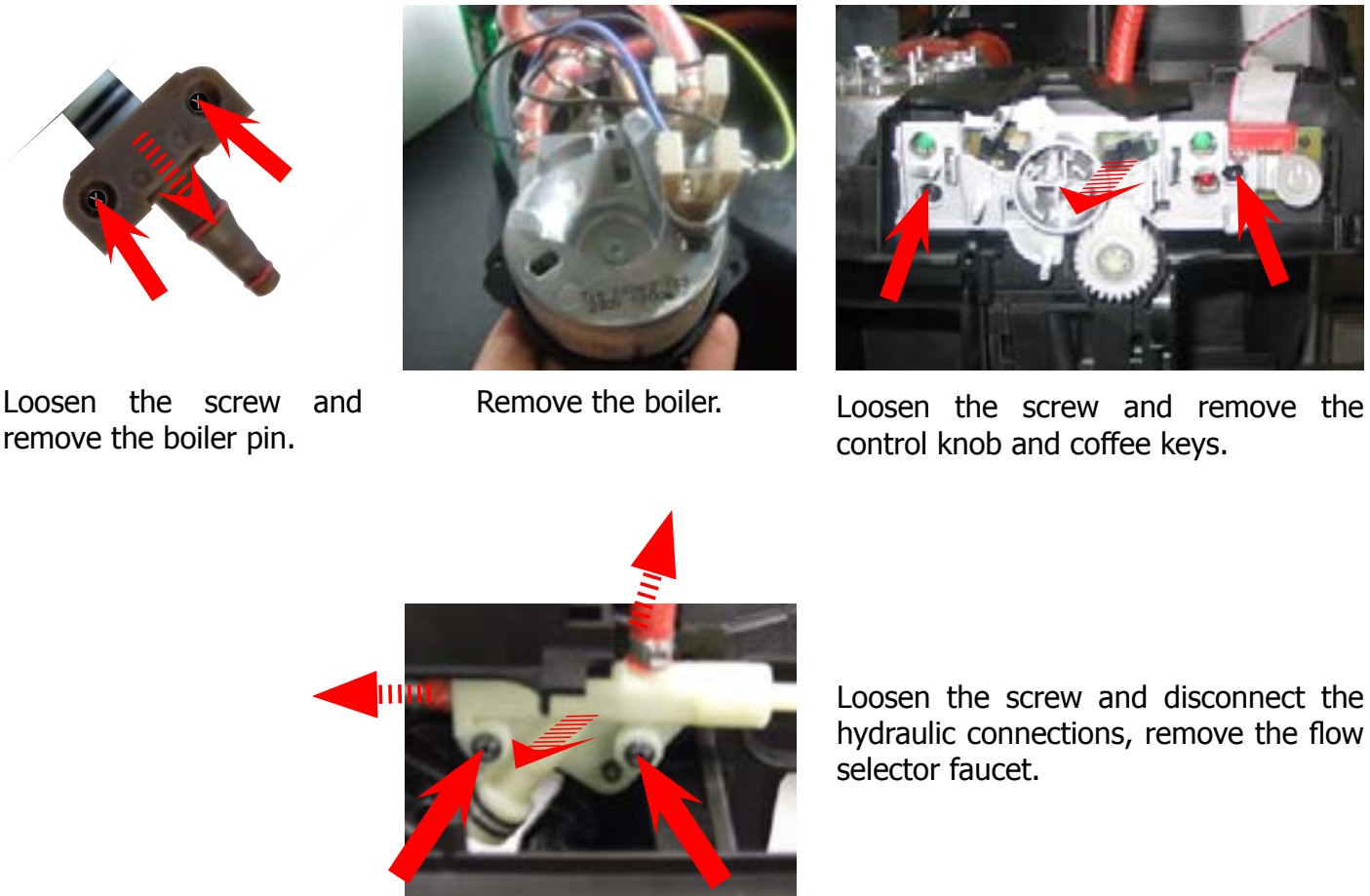

Loosen the screw and remove the boiler pin.

Remove the boiler.

Loosen the screw and remove the control knob and coffee keys.

Loosen the screw and disconnect the hydraulic connections, remove the flow selector faucet.

7.8. The pump and turbine

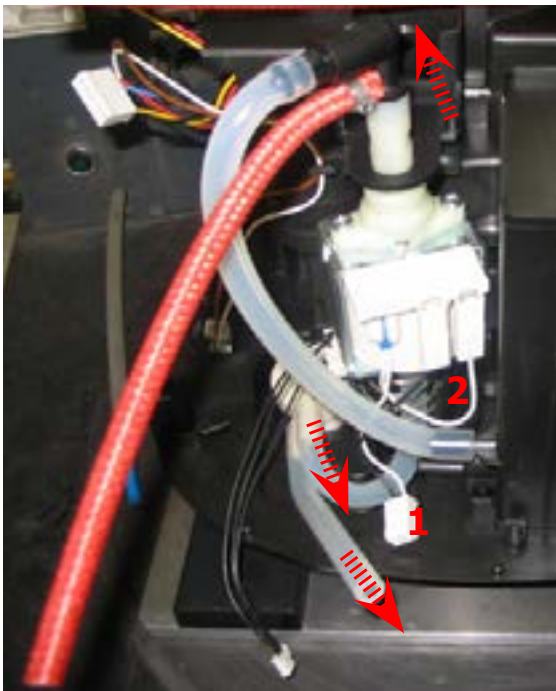

Slide out the support as shown.

Remove connection **1**, slide out the silicone hoses. To prevent annoying vibrations when reassembling the pump, take extra care when positioning spring **2**.

At this point, the turbine may also be removed from its recess.

7.9. The coffee grinder



1) To remove the coffee grinder, simply slide it out and remove its connections.

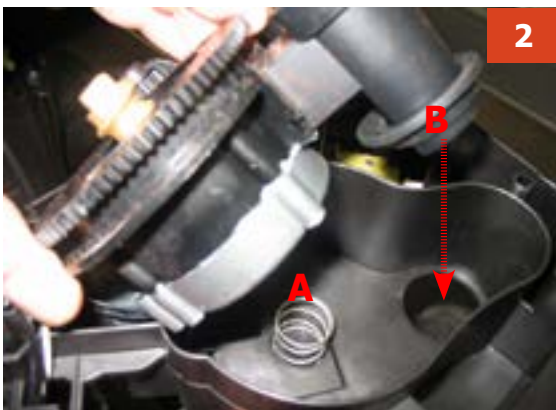

2) When replacing it, make sure the spring (A) and the coffee pipe (B) are positioned correctly.

7.10. Grinder adjustment/assembly and disassembly



1) To remove the upper grinder support, using a hex key push down and turn clockwise to release the grinder support from the bayonet coupling



2) To remove the grinder blade from the upper support, turn it anti-clockwise until it detaches from the bayonet coupling



3) To remove the lower grinder blade, keep the increment pin (A) locked in position and turn the grinder blade anti-clockwise, until it detaches from the bayonet coupling



4) When refitting the upper grinder support, make sure you reposition it so that the mark is as illustrated in the photo

7.11. OETIKER clamps assembly and disassembly

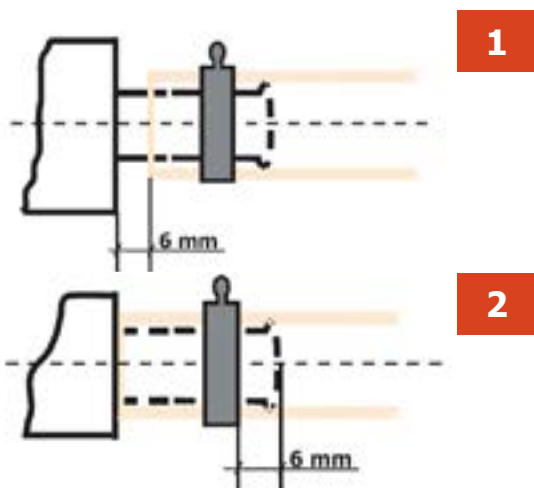

1) Boiler connection

2) Other connections



Replacing the hoses

1) Use a suitable pair of pliers to remove the clamp (as illustrated)



2) Tighten the clamp as illustrated

CHAPTER 8

NOTES

CHAPTER 9

WATER CIRCUIT DIAGRAM

9.1. Water circuit diagram Puro

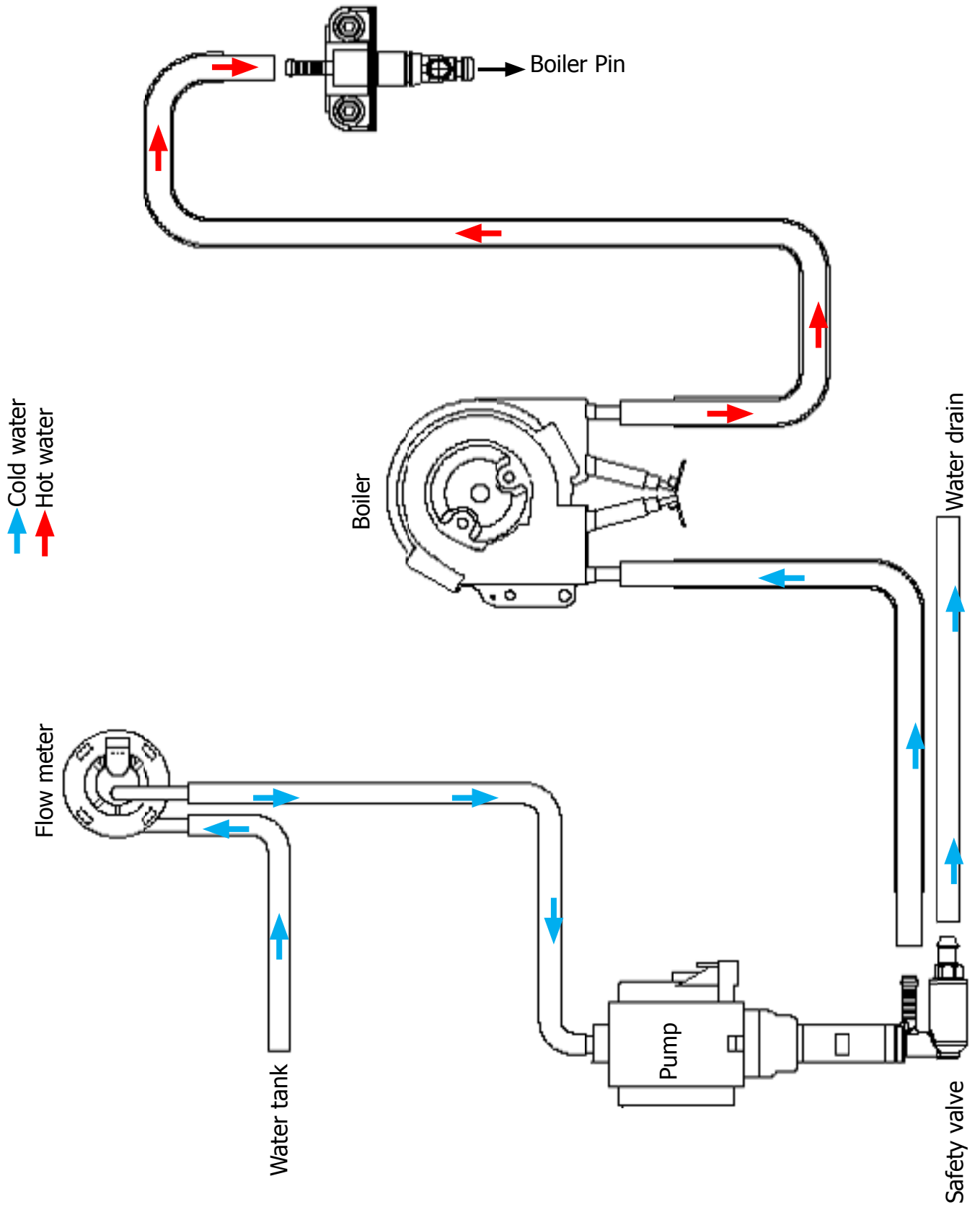

9.2. Water circuit diagram Vapore

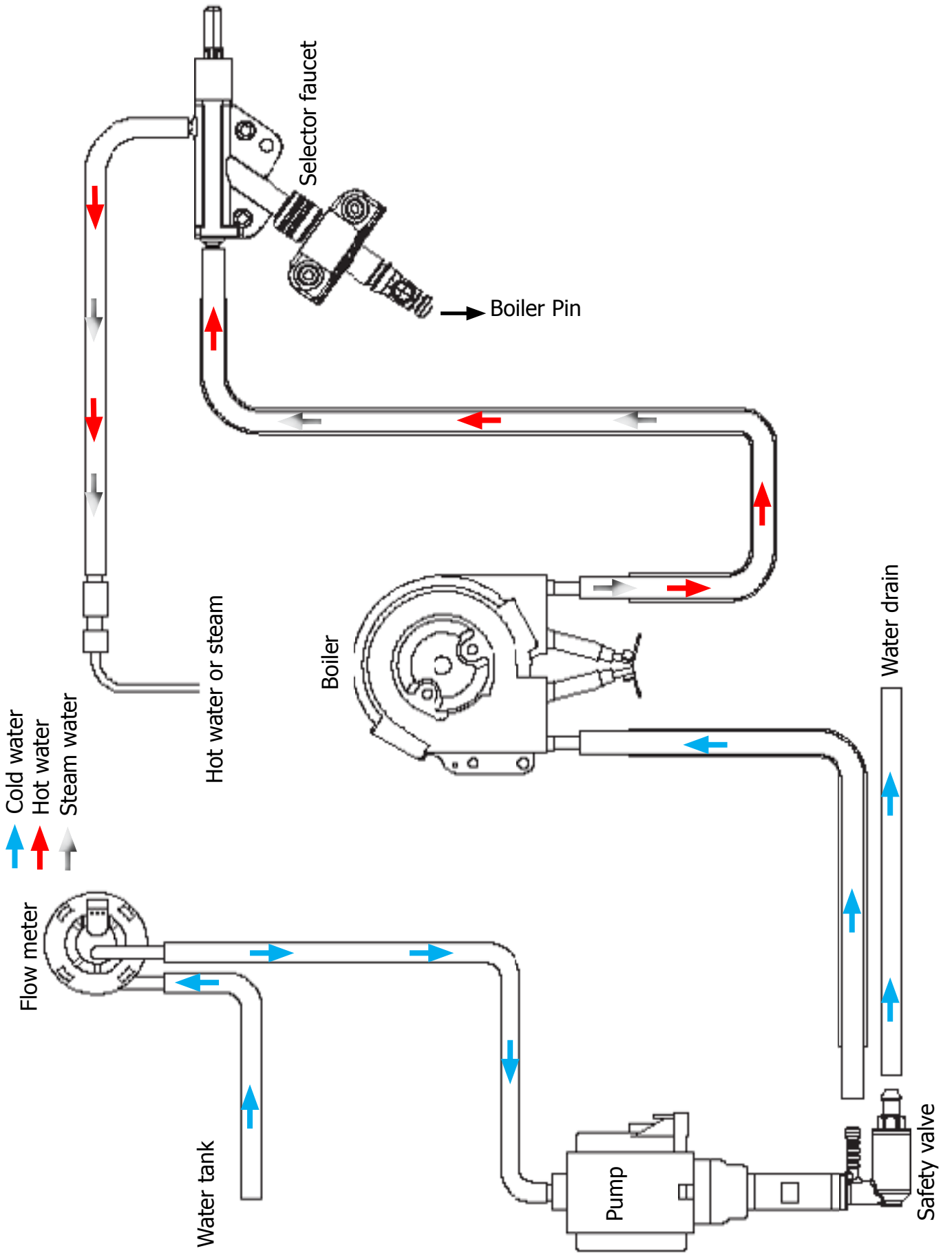

CHAPTER 10

ELECTRICAL DIAGRAM

10.1. Electrical diagram PHI 2000 Puro/Vapore

