

XSMALL

SERVICE MANUAL

Revision 00

All parts of this document are the property of Saeco International Group. All rights reserved. This document and all the information herein is provided without liability deriving from any errors or omissions. Furthermore, no part may be reproduced, used or collected, except where express authorisation has been provided in writing or through a contractual agreement.

Contents

	Page
1. Introduction	
1.1 Documentation required	1
1.2 Tools and equipment required	1
1.3 Material	1
1.4 Safety warnings	1
1.5 Xsmall range	2
1.6.1 External machine parts	3
1.6.2 Internal machine parts	4
2. Technical specifications	
2.1 Technical specifications	1
2.2 Machine parameters and performance	2
3. Brief instructions	
3.1 Customer and programming menu	1
3.2 Operation, cleaning and maintenance	3
4. Operating logic	
4.1. Water circuit	1
4.2 Control ringnut and valve	2
4.3 Coffee cycle operating diagram	3
4.4 Single microswitch	4
4.5 Temperature sensor	4
4.6 Coffee grinder operation	5
4.7 Low bean level detection, dose quantity adjustment, coffee grinder blocked	5
4.8 Dose self-learning	6

Contents

	Next
5. Troubleshooting	
5.1. Test mode	1
5.2. Draining the boiler (Steam Out)	2
6. Servicing & Maintenance	
6.1 Repair schedule	1
6.2 Service schedule	1
6.3 Final test	2
7. Disassembly	
7.1 Disassembling the outer elements	1
7.2 Disassembling the electronics	2
7.3 Disassembling the control knob and coffee keys	3
7.4 Disassembling the boiler pin	3
7.5 Disassembling the gear motor	4
7.6 Disassembling the boiler	5
7.7 Disassembling the valve	5
7.8 Disassembling the pump and turbine	6
7.9 Disassembling and fitting OETIKER clamps	7
7.10 Disassembling the coffee grinder	8
7.11 Grinder adjustment/assembly and disassembly	9
8. Notes	
9. Water circuit diagram	
9.1. Water circuit diagram	
10. Electrical diagram	
10.1 Wiring diagram	

CHAPTER 1

INTRODUCTION

1.1 Documentation required

The following documentation is needed for repair procedures:

- Instruction booklet for specific model.
- Technical documentation for specific model (diagrams, exploded drawings).

1.2 Tools and equipment required

As well as the standard equipment, the following is required:

Qty	Description	Notes
1	Screwdriver	Torx T 10
1	Pliers for Oetiker clamps	
1	CC -A - Vdc tester	
1	Digital thermometer	Scale limit > 150°C
1	SSC (Saeco Service Center)	Programmer

1.3 Material

Description	Notes
Thermal paste	Heat resistance > 200°C
Descaler	Saeco Entkalker
Grease solvent	Personal preference
Silicone grease	Safe to use with food

1.4 Safety warnings

We recommend you consult the technical manual of the machine before performing any maintenance work.

Observe all applicable standards relating to the repair of electrical appliances.

Always disconnect the power plug from the mains before beginning repair work.

Simply turning off the main machine power switch is not an adequate safety precaution.

This domestic appliance is rated as insulation class I.

On completion of the repair work, insulation and dielectric rigidity tests must be performed.

1.5. Xsmall range

**Xsmall Plus****Xsmall Steam**

	Xsmall Plus	Xsmall Steam
Painted details	X	
Water/steam valve	X	X
Alarm LED	X	X
Automatic rinse	X	X
Automatic dosage	X	X
Frother	X	
Dispensed coffee memory capacity	X	X
Automatic shutdown (after 60' inactivity)	X	X

1.6.1 External machine parts

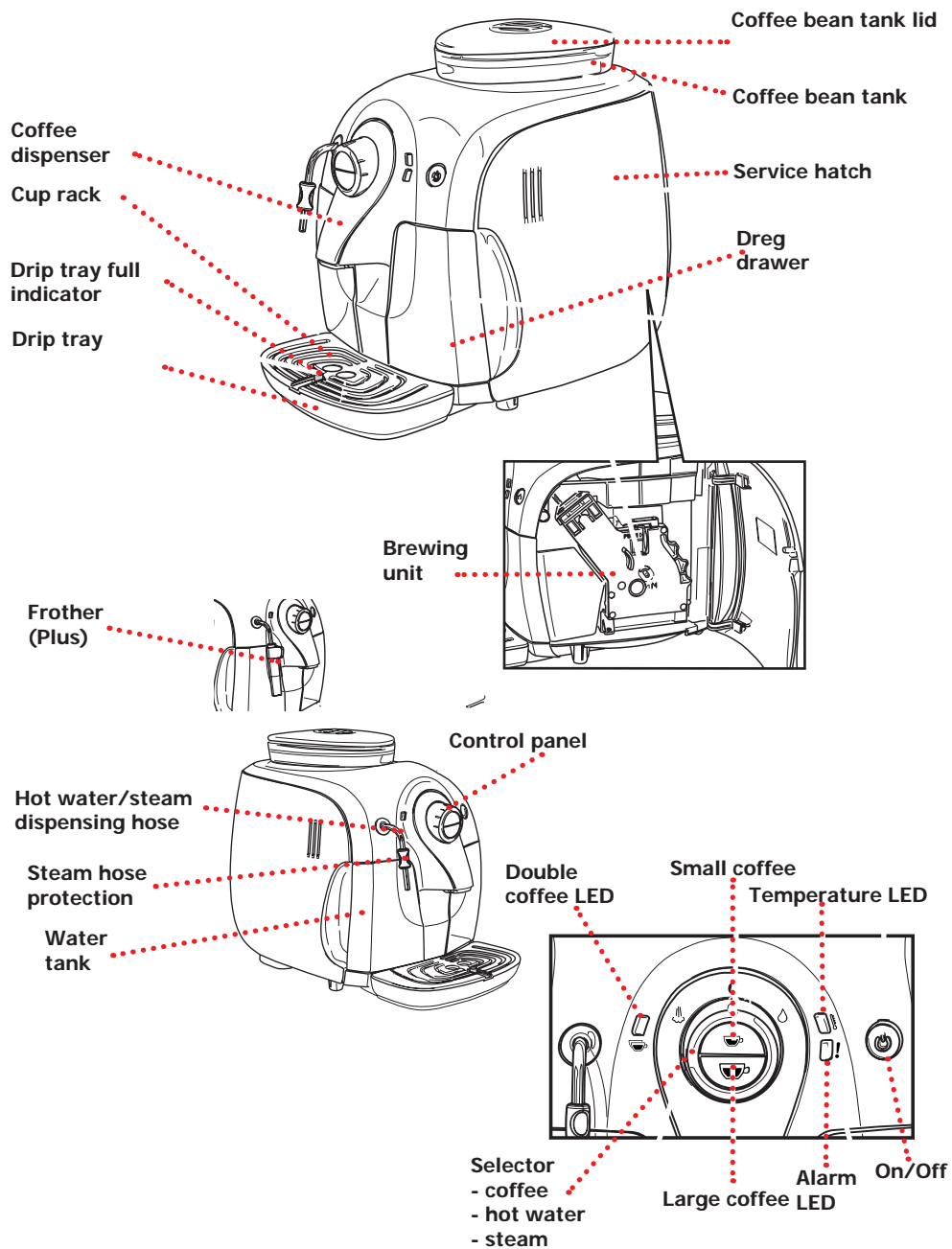

1.6.2 Internal machine parts

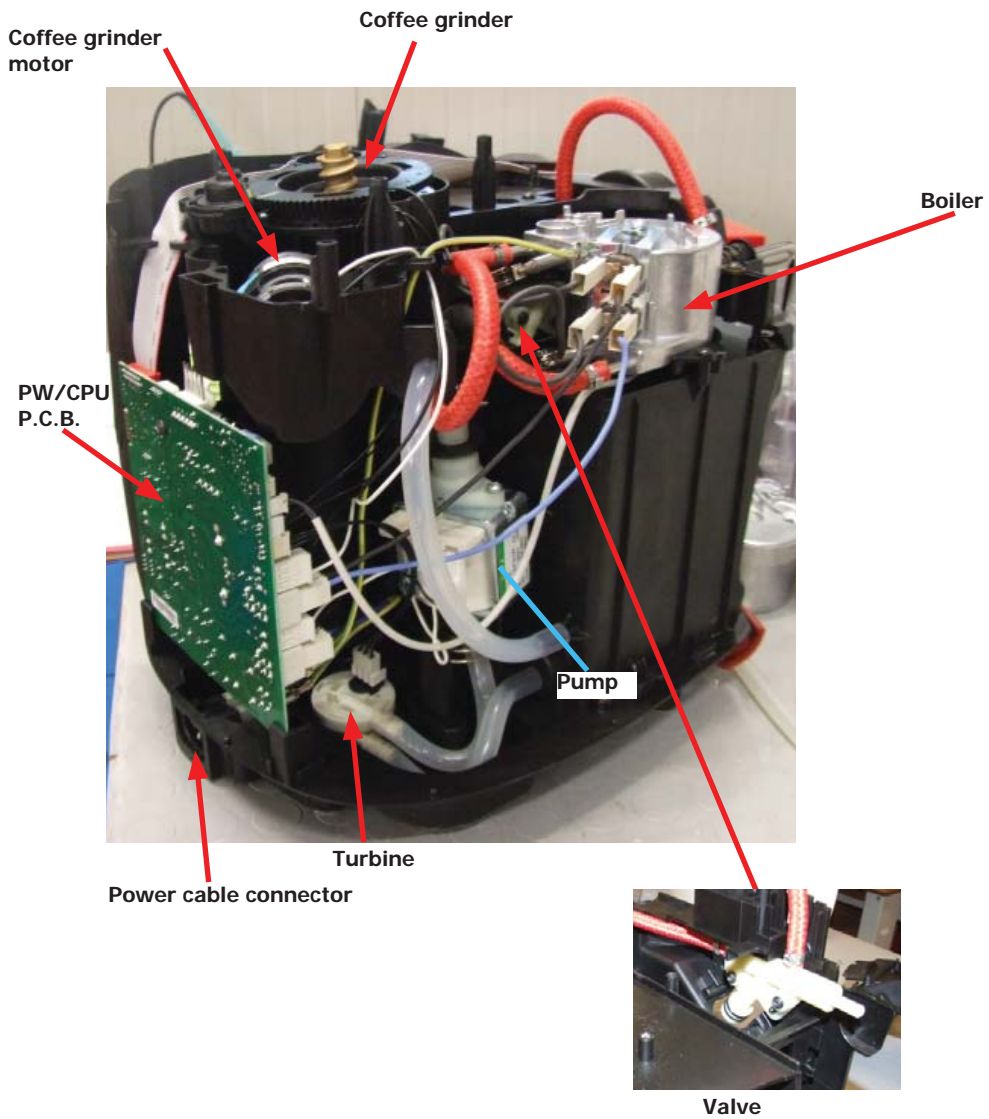

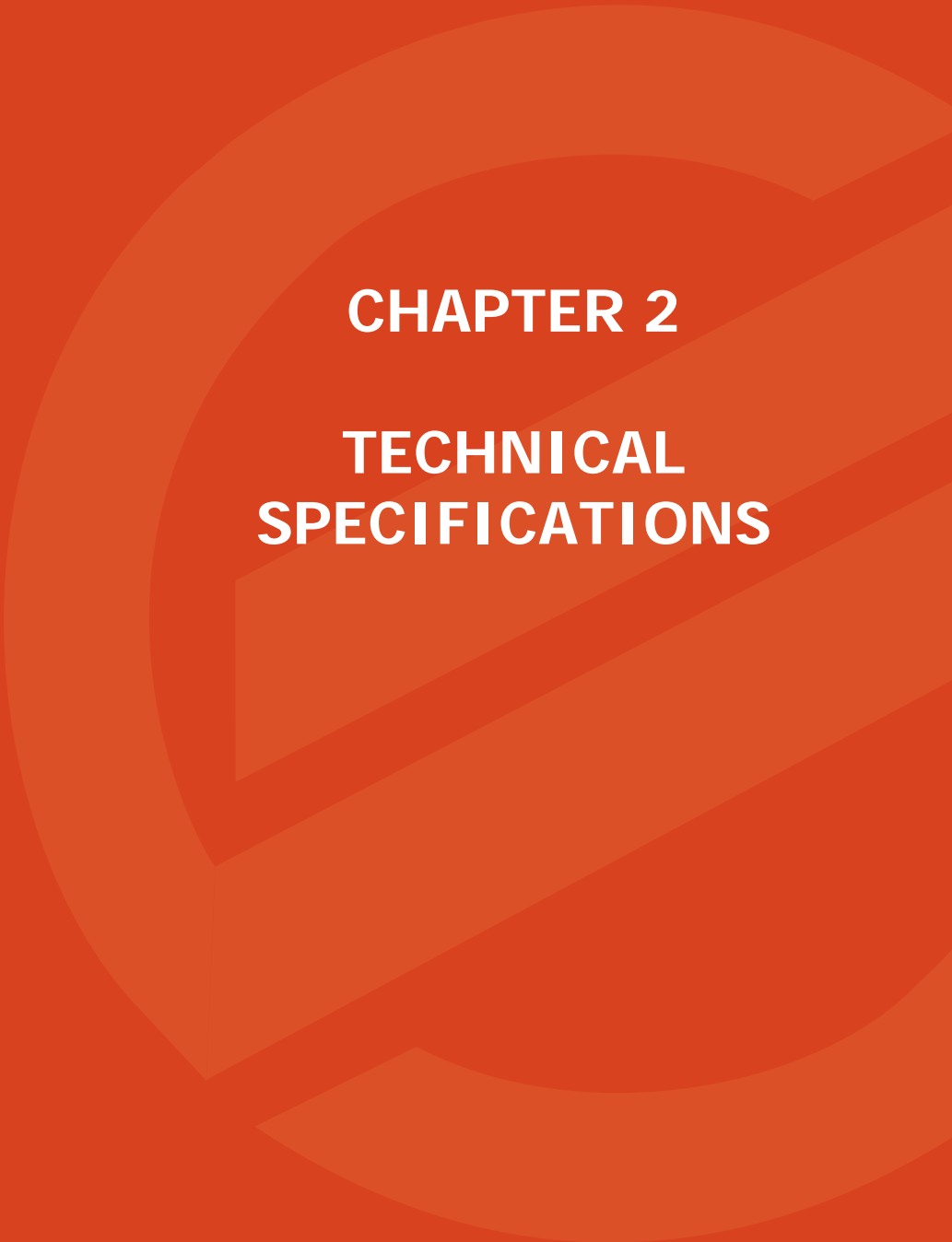

CHAPTER 2

TECHNICAL SPECIFICATIONS

2.1. Technical specifications

Power supply and output:	230 V~ 50/60 Hz 1500 W - 120 V~ 60 Hz 1500 W - 100 V~ 50/60 Hz 1300 W
Temperature monitoring:	Variable resistor sensor (NTC) - transmits the value to the electronic P.C.B.
Safety system:	2 manual reset or one-shot thermostats (175°C)
Coffee heat exchanger output: Stainless steel	(230/120 V~) 1300 W - (100 V~) 1100 W for coffee, hot water and steam dispensing
Gear motor:	33VC with 2 rotation directions; power supply 24VC
Pump:	Ulka with reciprocating piston and 100°C cutout 48 W, 230 V, 50 Hz, Type EP5 approx. 13-15 bar 120 V, 60 Hz 100 V, 50/60 Hz
Overpressure valve:	Opens at approx. 16-18 bar
Water filter:	In tank
Coffee grinder:	Direct current motor with flat ceramic grinders
Hot water/steam valve	Presblock
Automatic dosage	Dose adjustment controlled by the electronic system
Power consumption:	During the heating phase - approx. 5.6 A
Dimensions: W x H x D in mm:	295x325x420
Weight:	6.9 kg
Water tank capacity:	1.0 litres
Coffee container capacity	185 g coffee beans
Coffee dreg drawer capacity	08
Heat exchanger capacity:	Approx. 10 cc
Water circuit filling time:	Approx. 15 seconds for first filling cycle
Heating time:	Approx. 45 seconds
Dispensing temperature:	Approx. 84 ± 4°C
Grinding time:	Approx. 8-10 seconds

2.2. Machine parameters and performance

AMOUNT OF PRODUCT	Minimum amount (Puls.)	Default amount (Puls.)	Maximum amount (Puls.)	Programm. by the user	Programm. by Production/Service department
Espresso	70	165	600	Yes	No
Medium coffee	No	No	No	No	No
Large coffee	70	440	600	Yes	No
Pre-ground	No				
Hot water	Continues until the water supply has been exhausted (fill circuit status)				
Steam for frother	Continues until the water supply has been exhausted (fill circuit status)				
Steam for Milk-Island	No				

02 TECHNICAL SPECIFICATIONS

XSMALL

RINSE	Initial rinse	Final rinse
When performed	When the coffee maker is activated When the boiler temperature is $\leq 50^{\circ}\text{C}$	When the machine is switched off electronically, manually or automatically after 60', if at least one coffee has been dispensed, before switching off
No. of pulses	180	80
Stopping option	Yes, by pressing any key	Yes, by pressing any key
User disable option	No	No
Production/Service department disable option	No	No
No. of pulses user adjustment option	No	No
No. of pulses Production/Service department adjustment option	No	No
Pulse range (Min. - Max.)	No	No

WATER HARDNESS

CANNOT BE SET

DREGS DRAWER	Description and values
Time-out for dreg drawer	5 sec.
Empty dreg drawer alarm after (double coffee is the last product dispensed)	8 lots of dregs (9 lots of dregs)
Warning to empty dreg drawer after	No
Reset dregs counter	Every time the dreg drawer is removed for at least 5 seconds, even if the "empty dregs" alarm has not been activated

POWER/OFF	Description and values
Inlet time (min. - max.)	60 minutes
Inlet time (default)	No
Inlet time prog. by the user	No
Inlet time prog. by Production/Service department	No

WATER TANK	Description
Level sensor	No
Water reserve (pulses) with water filter	No
Water reserve (pulses) with no water filter	No
Water reserve modifiable by Production/Service departments	No
"Fill tank" alarm	No
"No tray" alarm	No
Water mains	No



CHAPTER 3



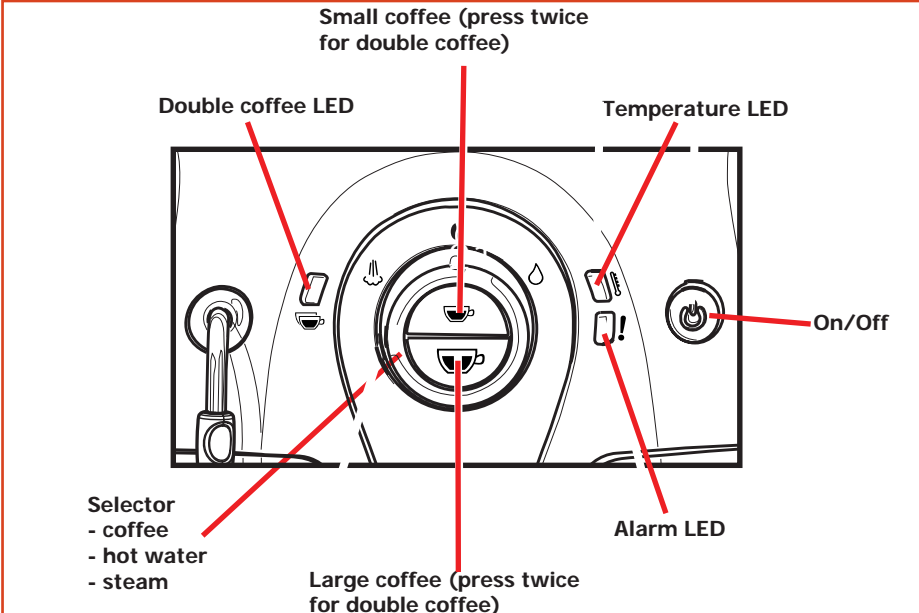

BRIEF INSTRUCTIONS







3.1. Customer and programming menu



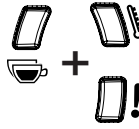

The diagram shows the front panel of the coffee machine with the following components labeled:

- Double coffee LED**: Located above the coffee selector.
- Temperature LED**: Located above the hot water/steam selector.
- On/Off**: A power button on the right side.
- Alarm LED**: A warning light on the right side.
- Selector**: A rotary switch with three positions: coffee, hot water, and steam.
- Small coffee (press twice for double coffee)**: A button above the coffee selector.
- Large coffee (press twice for double coffee)**: A button below the coffee selector.

Indications	Causes	Solutions
Fixed 	Machine at correct temperature - for coffee dispensing - for hot water dispensing - for steam dispensing	
Blinks slowly 	Machine in pre-heating phase for coffee, hot water and steam dispensing.	
Blinks quickly 	Machine overheated; the machine cannot dispense coffee in this mode.	The water must be drained out into a recipient by turning the selector clockwise to the "☹" point, until the green correct temperature LED remains lit in a fixed manner. The flow of water dispensed should then be stopped.
 Blinks slowly	The machine is being programmed with the coffee cup fill level	
 Fixed	Machine dispensing coffee	

Indications	Causes	Solutions
Fixed 	Coffee bean container empty Dreg drawer full	Fill the coffee bean tank. Empty the dreg drawer while the machine is switched on. If the drawer is emptied before the indication appears and the drawer remains out of position for at least 5 seconds, the dregs counter will still be reset.
Blinks quickly 	Water circuit drain	Fill the tank with fresh drinking water and fill the water circuit of the machine by turning the selector to the "☉" point; wait for a continuous jet of water to come out of the steam hose.
Blinks slowly 	Brewing unit not present Dreg drawer not present Service hatch open Valve position NOT suitable for machine operation	To stop the red blinking light, make sure that all components are inserted or closed correctly.
Blinking in an anti-clockwise sequence (cyclically) 	The machine is performing its rinse / automatic cleaning cycle - When the machine is switched on (the boiler is cold) - After filling the circuit (the boiler is cold) - Before the machine enters Standby mode (if it has dispensed a coffee) - During the shutdown phase, after the ON/OFF key has been pressed (if the machine has dispensed a coffee)	The machine ends the cycle automatically. The cycle may be stopped by pressing one of the two coffee keys.
Blinking simultaneously 	The machine is experiencing a fault and will not dispense coffee, water or steam	Switch the machine off, wait for 30 seconds and switch it back on again. Repeat 2 or 3 times. If the machine does not start, enter test mode.
Blinking in alternating fashion 	The brewing unit has experienced a fault	Try to carry out a coffee dispensing cycle again.

3.2. Operation, cleaning and maintenance

Operating the machine		
1	Fill the water tank	
2	Fill the coffee bean container	
3	Switch on the appliance	
4	Fill the circuit	Place a recipient underneath the steam hose and turn the selector towards the “  ” symbol; wait until the LED  stops blinking.
5	Press the coffee key	Press once for one coffee; twice for two coffees.

CLEANING AND TECHNICAL SERVICING		
A	Empty the coffee dreg drawer	When indicated
B	Empty the drip tray	As necessary or when indicated
C	Clean the water tank	Weekly
D	Clean the coffee bean container	As necessary
E	Clean the casing	As necessary
F	Clean the brewing unit	Every time the coffee bean container is filled, or weekly, or
	Lubricate the brewing unit	Once a month or every 500 dispensing procedures
	Clean the unit housing	Weekly
H	Perform descaling	Every 1 or 2 months, or when you notice a reduction in the water flow rate

Descaling cycle frequency			
Hardness	Water hardness	Without limescale filter	With limescale filter
1	Soft water (up to 7°dH)	Approx. every 3 months / 120 litres	Approx. every 6 months / 240 litres
2	Medium water (7° - 14°dH)	Approx. every 2 months / 90 litres	Approx. every 4 months / 180 litres
3	Hard water (15° - 21°dH)	Approx. every 6 weeks or 60 litres	Approx. every 3 months / 120 litres
4	Very hard water (over 21°dH)	Approx. every 4 weeks or 30 litres	Approx. every 6 weeks or 60 litres



CHAPTER 4

OPERATING LOGIC

4.1. Water circuit

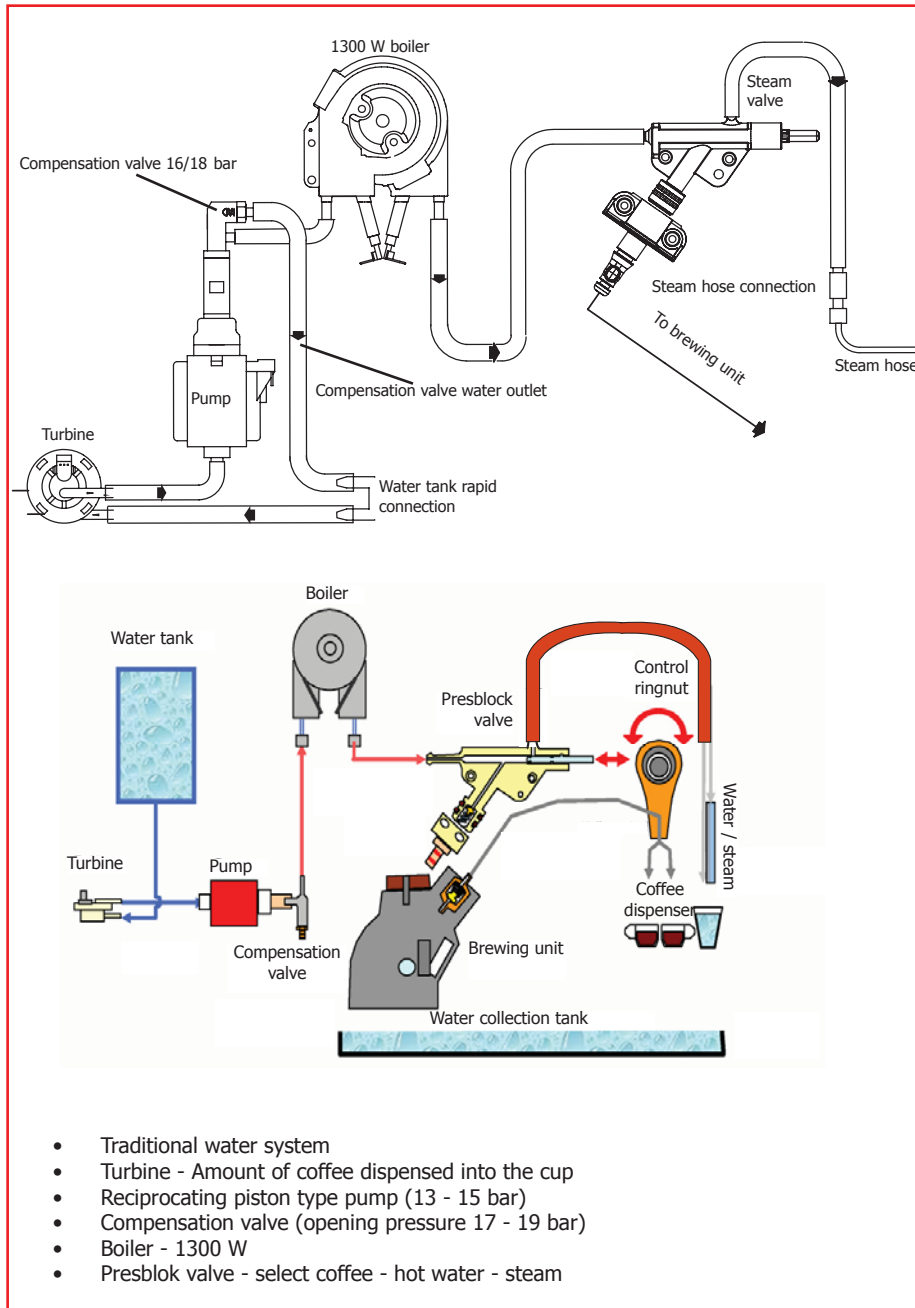

4.2. Control ringnut and valve

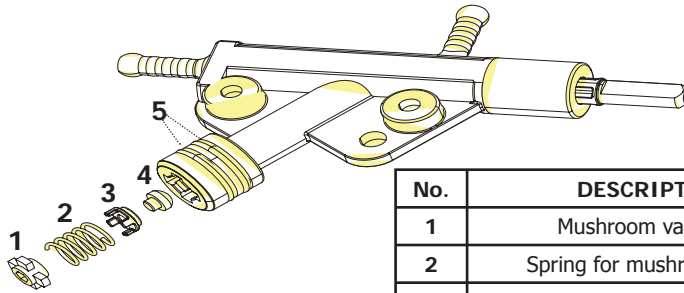

No.	DESCRIPTION
1	Mushroom valve cap
2	Spring for mushroom valve
3	Mushroom valve support
4	Mushroom valve
5	Sealing OR

When dispensing coffee the mushroom valve opens at 4 bar +/- 0.5

Manual opening when dispensing water

Manual opening when dispensing steam

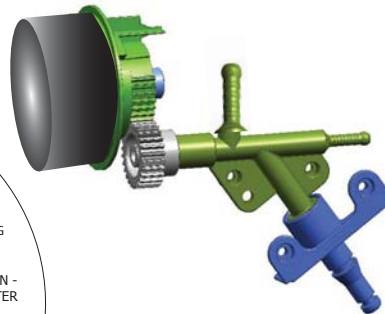
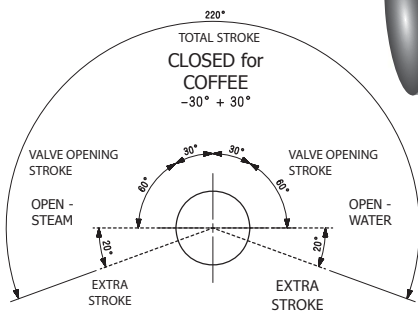

4.3. Coffee cycle operating diagram

Main switch ON	START		STOP
Time			
Coffee grinder		Pulses (Dosage)	
Heating	approx. 45 secs.		
Pump		*	Pump operation (turbine pulses) in accordance with the amount of product selected.
Brewing unit gear motor	↓ ↑	↑	↓ ↑
Status	Heating	Ready	Coffee cycle

Notes: * Only with Pre-brewing



Single microswitch gear motor

Switching on

When the machine is switched on, the gear motor repositions itself as follows:

- It acts on microswitch 1 (see following section).
- The gear motor changes its rotation direction and moves upwards again by approx. 1-2 mm.
- The boiler begins to heat water for approx. 45 seconds. It absorbs all the available heating power in order to reach the optimal temperature. The temperature will then remain at a constant level.

Coffee cycle

1. The coffee grinder starts the grinding process (controlled by pulses generated by a sensor).
2. The gear motor (brewing unit) moves to the dispensing position.
3. Preliminary dispensing phase (short pump activity, short pause).
4. Product dispensing (the pump operation period is defined by the amount of product dispensed).
5. The gear motor moves to its home position (the dregs are expelled automatically).

4.4. Single microswitch

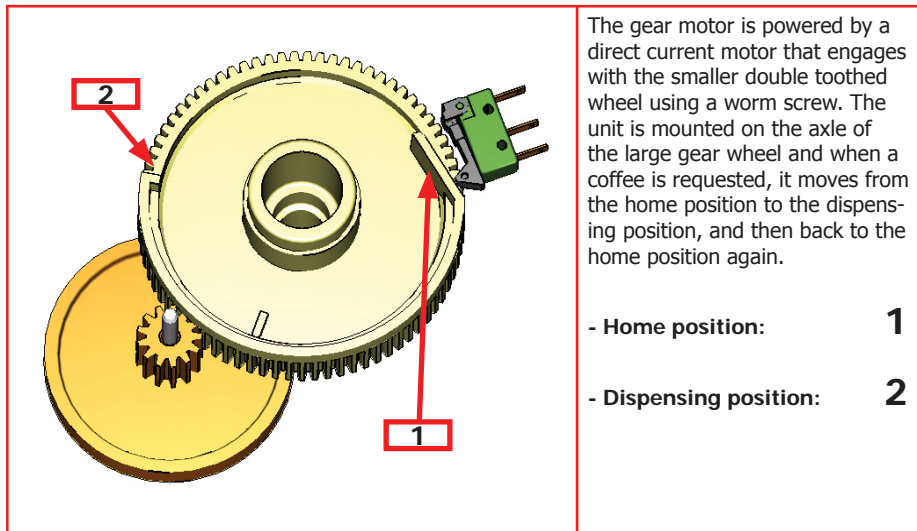

The gear motor is powered by a direct current motor that engages with the smaller double toothed wheel using a worm screw. The unit is mounted on the axle of the large gear wheel and when a coffee is requested, it moves from the home position to the dispensing position, and then back to the home position again.

- Home position: 1
- Dispensing position: 2

4.5. Temperature sensor (adjustment)

Temp. (° C)	R nom (kΩ)	ΔR (+/- %)
20	61,465	8,6
50	17,599	5,9
75	7,214	4,1
80	6,121	3,7
85	5,213	3,4
90	4,459	3,1
100	3,3	2,5
125	1,653	3,9
150	0,893	5,1

Temperature sensor

An NTC is used as a temperature sensor; in the event of overheating this reduces resistor consumption.

The electronic system detects the current boiler temperature from the drop in voltage and adjusts it accordingly.

Resistor values: see table

4.6. Coffee grinder function

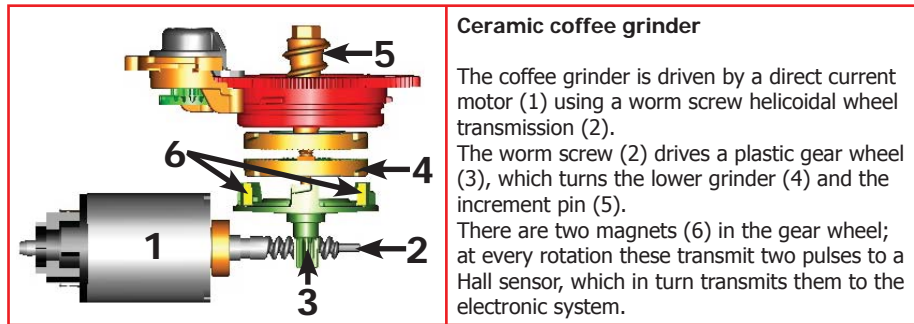

4.7. Low bean level detection, dose quantity adjustment, coffee grinder blocked

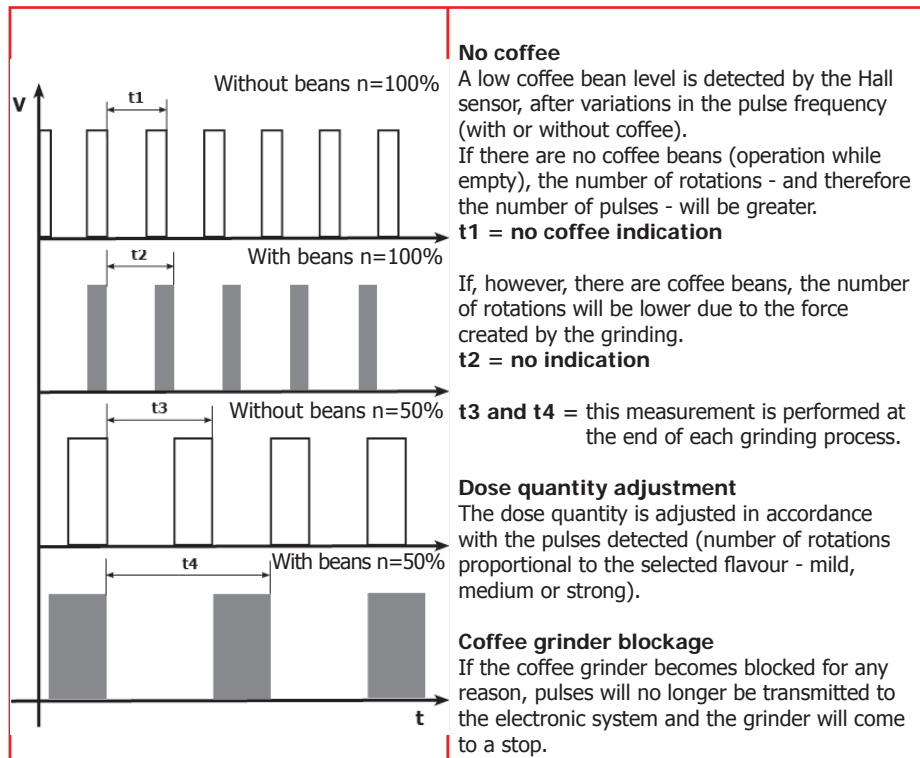

4.8 Dose self-learning

The aim of this modification process is to ensure that, with an algorithm based on three pieces of information (listed below) detected by the machine P.C.B., the average dose is adjusted automatically (SELF-LEARNING).

1. Number of coffee grinder pulses taking place during the grinding cycle
2. Max. average value of the power consumed by the gear motor during the coffee brewing cycle
3. Flavour selected by the user

The algorithm compares the maximum average value of the power consumed by the unit with the value listed in the table for the selected flavour, in order to calculate the new grinding pulse value for the next coffee produced.

If the value of the power consumed by the gear motor is lower than the value of the min. current, the grinding pulses will be increased by 2.

If the value of the power consumed by the gear motor is greater than the value of the maximum current, the grinding pulses will be decreased by 4.

If the "pre-ground" flavour is selected by the user, no modification will be made.

Min. current (mA)	Max. current (mA)	Flavour (pluses)
200	300	Mild (- 10% of the average value)
301	450	Average (nominal)
451	600	Strong (+ 10% of the average value)
-	-	pre-ground

If the value of the power consumed by the gear motor falls within the "overwork" interval, the grinding pulses will be decreased by 10 and the product will be dispensed.

If the value of the power consumed by the gear motor falls within the "expulsion" interval, the grinding pulses will be decreased by 10 and the pad will be dispensed.

Min. current (mA)	Max. current (mA)	Flavour (pluses)
800	1000	Overwork
1001	- -	Pad expulsion





CHAPTER 5

TROUBLESHOOTING

5.1. Test mode





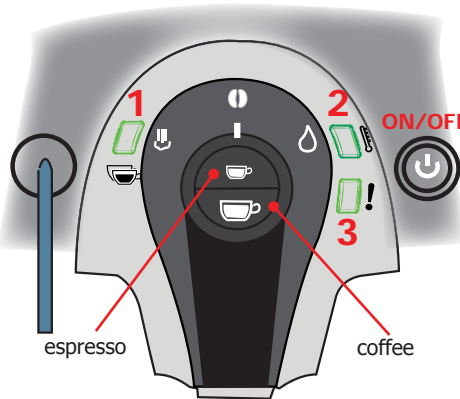

To enter TEST MODE, proceed as follows:
 MAKE SURE THE MACHINE IS UNPLUGGED.















- Turn the selector to the water position  and press and hold the espresso coffee key  while you plug the machine in.
- Confirmation that the machine is in TEST MODE is signalled by LEDs 1, 2 and 3 lighting up in a cyclical manner.
 Release the espresso key; LEDs 1 and 2 will remain lit.



There are four **LEVELS** of checking (to move to a higher level, press the **(on/off)** key

- L0** MICROSWITCHES OPERATIONAL CHECK (unit, dreg drawer, hatch)
- L1** BREWING UNIT OPERATIONAL CHECK (power consumption and stroke limit microswitch)
- L2** PUMP AND TURBINE OPERATIONAL CHECK
- L3** BOILER AND COFFEE GRINDER OPERATIONAL CHECK

lev.	pos. selector	LED	key	function	notes
L0 Operational check - microswitches	☐	 ON			
		 ON			
		OFF		Microswitch: dreg drawer unit hatch	
	☐ OR ☐	 blinks once		insert unit	When the unit is removed and replaced, wait for at least 5 sec.
		 blinks once		insert dreg drawer	Always insert the components in this sequence
		 blinks once		close hatch	
	☐	☐		  ON	check keys
PRESS THE ON/OFF KEY TO ACCESS THE NEXT LEVEL UP					

lev.	pos. selector	LED	key	function	notes	
L1 Operational check - brewing unit		 ON		brewing unit microswitch	Gear motor rises (brewing unit in work position)	
		 ON		brewing unit microswitch	Gear motor falls (brewing unit in home position)	
		 OFF			power consumption of the unit in mA	OK
		 Blinks				Between 200 and 300 mA OK with unit inserted
		 ON				KO over 300 mA
PRESS THE ON/OFF KEY TO ACCESS THE NEXT LEVEL UP						
L2 Operational check - pump and turbine		 Blinks		pump operation	Make water come out of the steam hose	
				turbine operation	Each blink corresponds to one turbine rotation	
				coffee pipe operation	Return to L1 and switch the unit to Work, return to L2 and make water come out of the dispenser	
PRESS THE ON/OFF KEY TO ACCESS THE NEXT LEVEL UP						
L3 Operational check - boiler/coffee grinder		 Blinks		power consumption of the boiler	Use an ammeter to check the power consumption is between 5.3 and 6.1 mA	
				coffee grinder operation		
				coffee grinder sensor	Each blink corresponds to one coffee grinder rotation	

5.2. Draining the boiler (Steam Out)

To drain the boiler, proceed as follows:

MACHINE UNPLUGGED

- Turn the selector to the water position  , press and hold the large coffee key and plug the machine in.
- The three LEDs light up and remain lit.
- Release the large coffee key; the LEDs will begin to blink in an anti-clockwise cycle and boiler draining will commence (remember to place a recipient underneath the steam hose).
- When the draining process is complete, the double coffee and temperature LEDs will remain lit.
- Unplug the machine to end this procedure.
- Press on/off; the coffee maker will begin filling the circuit (red LED 3 blinks quickly).

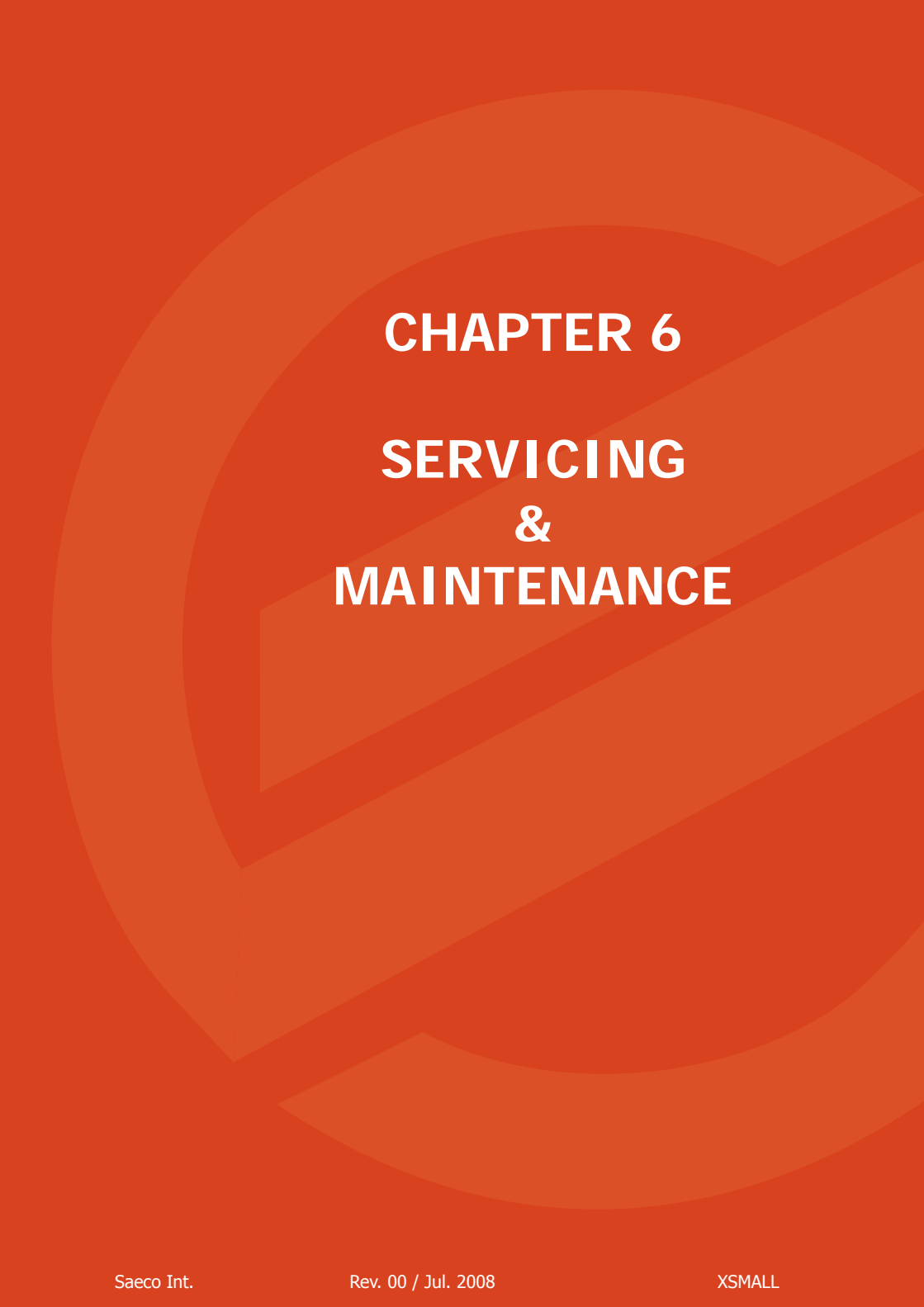

CHAPTER 6

**SERVICING
&
MAINTENANCE**

6.1. Repair schedule

	Action
1	Visual inspection (transport damage)
2	Machine data check (rating plate)
3	Operational check / problem analysis
4	Opening machine
5	Visual inspection
6	Operational tests
7	Repairing the faults encountered
8	Checking any modifications (view info, new sw, etc.)
9	Service activities in accordance with the operating schedule
10	Internal cleaning
11	Operational test while the appliance is open
12	Assembly
13	Final inspection test
14	Draining the circuit (in winter)
15	External cleaning
16	Lubricating the brewing unit with suitable grease
17	Insulation test HG 701 (dielectric)
18	Documentation

6.2. Service schedule

S = Replacement
TR = Noise test

P= Cleaning
D = Descaling

ES = Visual inspection
R = Adjustment

Component	Action	Support/tool
Water filter	P/S	
Water tank lip seal	S	
Boiler pin O-ring	S	
Brewing unit	P/ES	Grease solvent / Grease
Hoses, attachments and Oetiker clamps	ES	
Pump	ES/TR	
Gear motor	TR/ES	
Coffee grinder	P/R	Vacuum cleaner / brush
Water circuit	D	Saeco descaler
Hot water/steam valve	ES/S	

6.3. Final test

Test	Procedure	Support/ tool	Standard	Tolerance
Espresso	2-3 Espressos for adjustment purposes	Measuring beaker	Same amount	15%
Coffee	2-3 Coffees for adjustment purposes	Measuring beaker	Same amount	15%
Noise			Standard	
Amount of "crema"	Blow into the cup until the "crema" separates		The "crema" should come together again to form a complete layer	
"Crema" colour			Hazel brown	
Temperature	Reading taken while dispensing	Thermometer	84 °C	± 4 °C
Grinding level	Check the grain size of the ground coffee			
Hot water	Dispense water			
Steam	Dispense steam			
Dreg drawer missing indication	Remove the dreg drawer		Dreg drawer missing indication	
Low bean level indication	Start brewing a coffee while the coffee bean container is empty		Low bean level indication	

CHAPTER 7

DISASSEMBLY

7.1. Disassembling the outer elements

	<p style="text-align: center;">Disassembling the Top cover</p> <p>1/2) Remove the dreg drawer, water tank, mushroom finger protection device on the coffee container lid and coffee container, then loosen the screws shown.</p> <p>3/4) Slide out the steam hose protection, lift the cover at the rear by pressing down gently on the cooling vents to help detach the anchoring tabs, then pull it away from the steam hose, taking care not to scratch it.</p> 
--	---

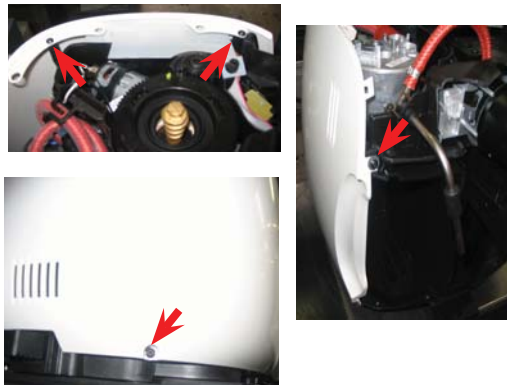
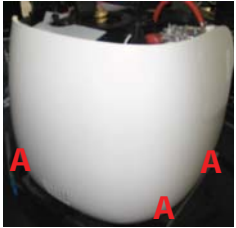
	<p style="text-align: center;">Disassembling the side cover</p> <p>Loosen the screws shown and slide out the side cover; be careful of the protrusions (A) on the base.</p> 
---	---

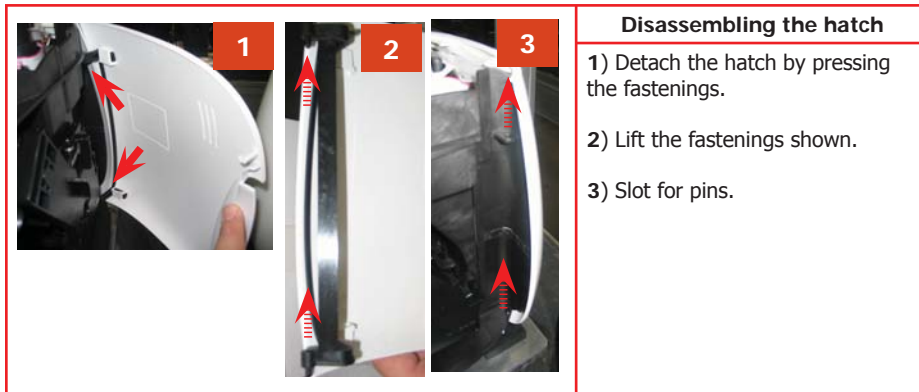

7.2. Disassembling the electronics

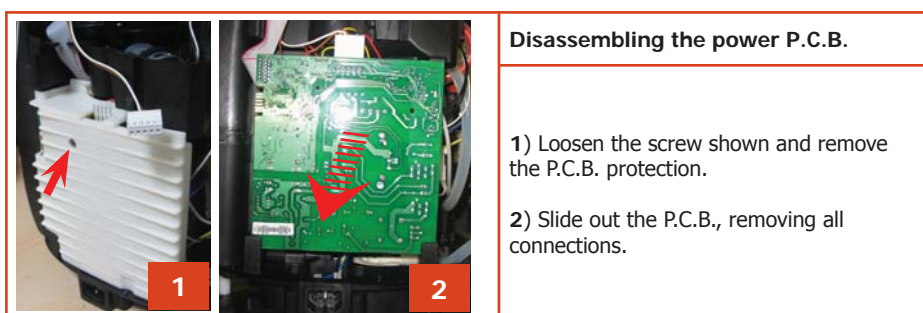

7.3. Disassembling the control knob and coffee keys

	Disassembling the Top cover
	<p data-bbox="687 622 1251 696">To remove the coffee keys from the control keypad, detach them from the anchoring device on the back of it and take them out.</p> <p data-bbox="687 880 1198 904">To remove the knob, simply slide it out of its position.</p>

7.4. Disassembling the boiler pin

	Disassembling the boiler pin
	<p data-bbox="874 1485 1270 1536">1) Loosen the screws shown and remove the boiler pin.</p>

7.5. Gear motor

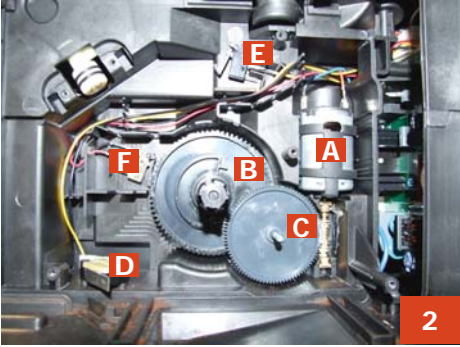
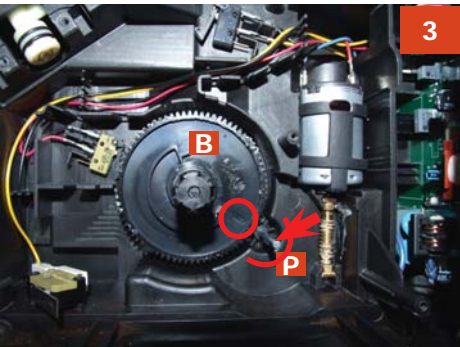
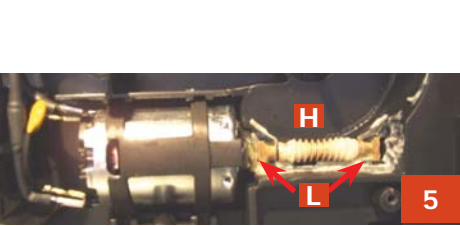
	Gear motor
 <p data-bbox="422 763 486 808">1</p>	
 <p data-bbox="715 1122 754 1167">2</p>	<p data-bbox="791 651 1206 725">1) Loosen the screws holding the boiler pin in place, remove it and loosen the other screws shown.</p> <p data-bbox="791 831 1158 882">2) The following are located inside the compartment protected by the casing:</p> <ul data-bbox="791 887 1190 1182" style="list-style-type: none"> - Electric motor (A) with gears (B) and (C) for transmission and timing of the brewing unit. - Dreg drawer present microswitch (D). - Brewing unit present microswitch (E). - Microswitch (F) intercepting the brewing unit home and dispensing phases. - Remove the gear (C) that meshes with the motor transmission shaft. - Remove the large gear (B). - Remove the motor (A), complete with transmission shaft.
 <p data-bbox="715 1189 754 1234">3</p>	<p data-bbox="791 1263 1206 1337">3) Replace the gear (B), making sure that the imprint of the arrow is aligned with the opening containing the pin (P).</p>
 <p data-bbox="715 1718 754 1762">5</p>	<p data-bbox="791 1547 1174 1644">4) When replacing the motor and the transmission shaft, make sure the guide runners (L) are in the right position. Grease the shaft thoroughly and evenly.</p>

7.6. Disassembling the boiler

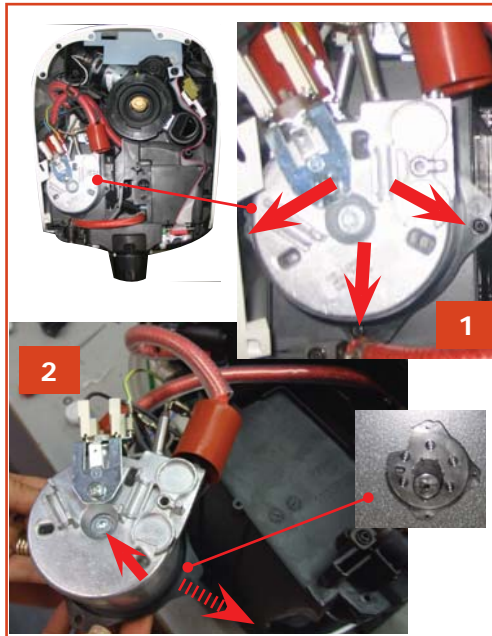

1) Loosen the screws shown.

2) Loosen the screw and remove the plastic support.
Disconnect the hoses and the connections.

7.7. Disassembling the valve

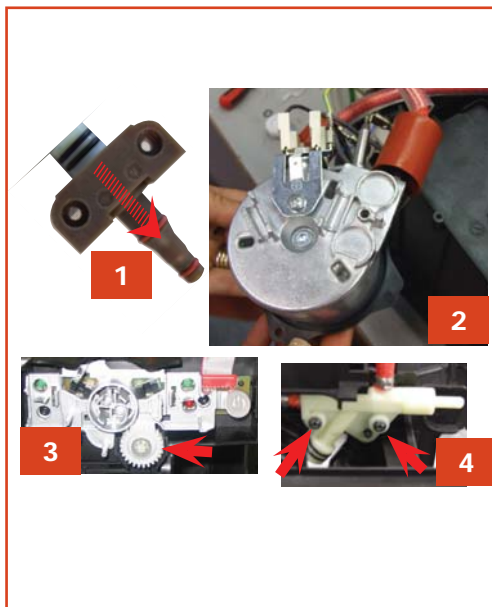

1) Remove the boiler pin.

2) Remove the boiler.

3) Remove the gear.

4) Loosen the screws shown.

7.8. Disassembling the pump and turbine



Slide out the support as shown.

Remove connection **1**, slide out the silicone hoses.

To prevent annoying vibrations when reassembling the pump, take extra care when positioning spring **2**.

At this point, the turbine may also be removed from its recess.

7.10. Fitting and removing OETIKER clamps

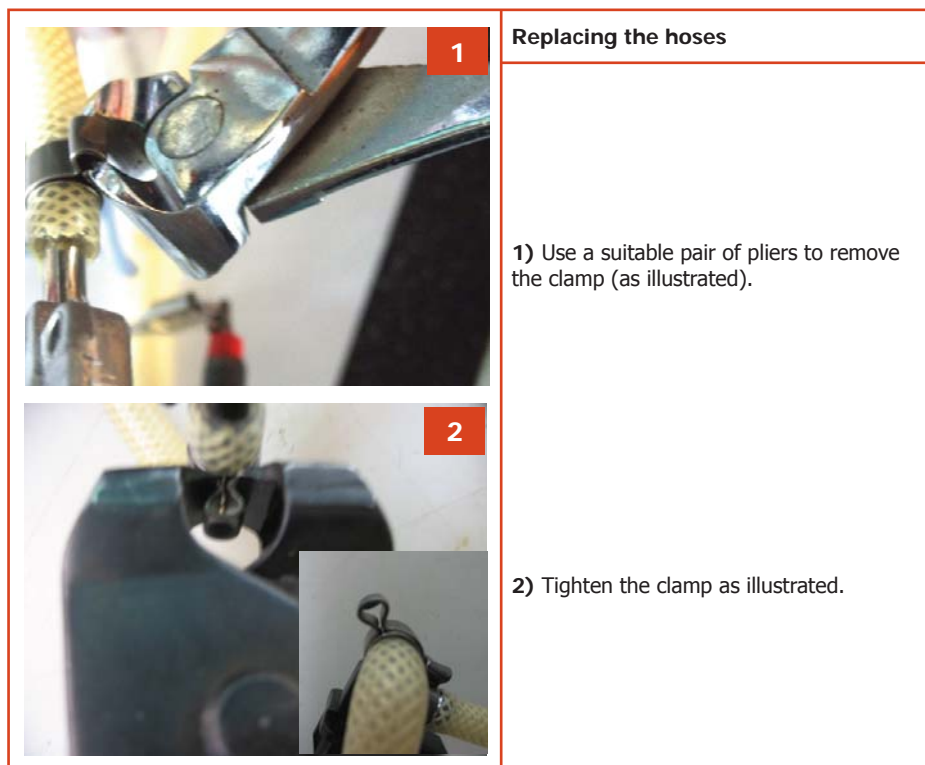
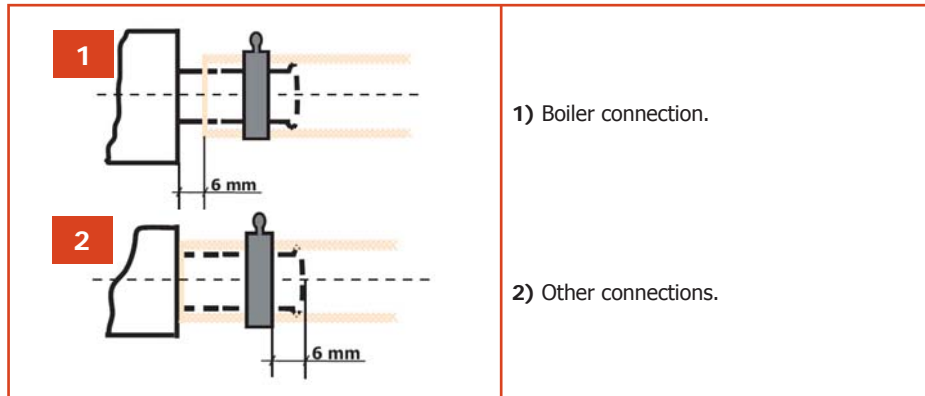

7.11. Disassembling the coffee grinder

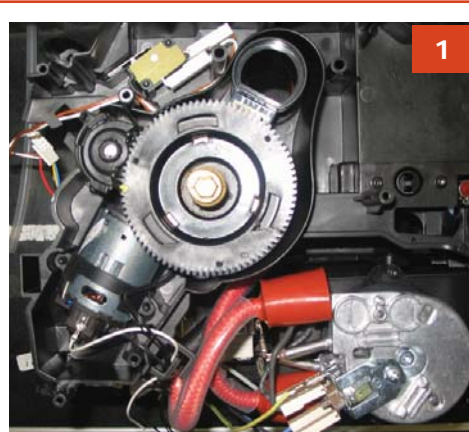

1) To remove the coffee grinder, simply slide it out and remove its connections.

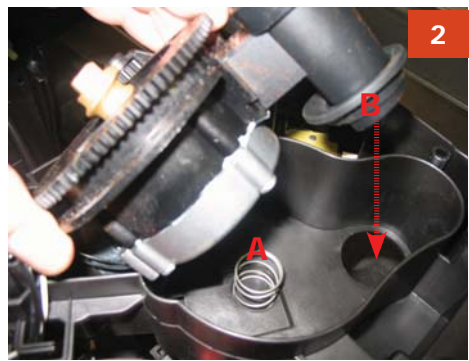

2) When replacing it, make sure the spring (A) and the coffee pipe (B) are positioned correctly.

7.12. Grinder adjustment/assembly and disassembly

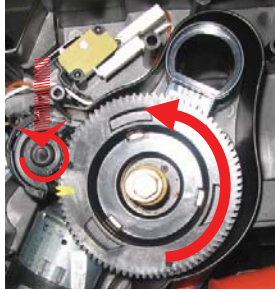

1



2



3

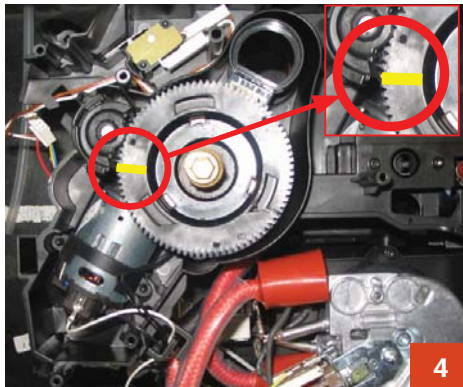

4

1) To remove the upper grinder support, use a hex key to exert pressure, turning it clockwise in order to release the grinder support from the bayonet coupling.

2) To remove the grinder from the upper support, turn it anti-clockwise until it detaches from the bayonet coupling.

3) To remove the lower grinder, keep the increment pin (A) locked in position and turn the grinder anti-clockwise, until it detaches from the bayonet coupling.

4) When refitting the upper grinder support, make sure you reposition it so that the mark is as illustrated in the photo.

CHAPTER 8

NOTES

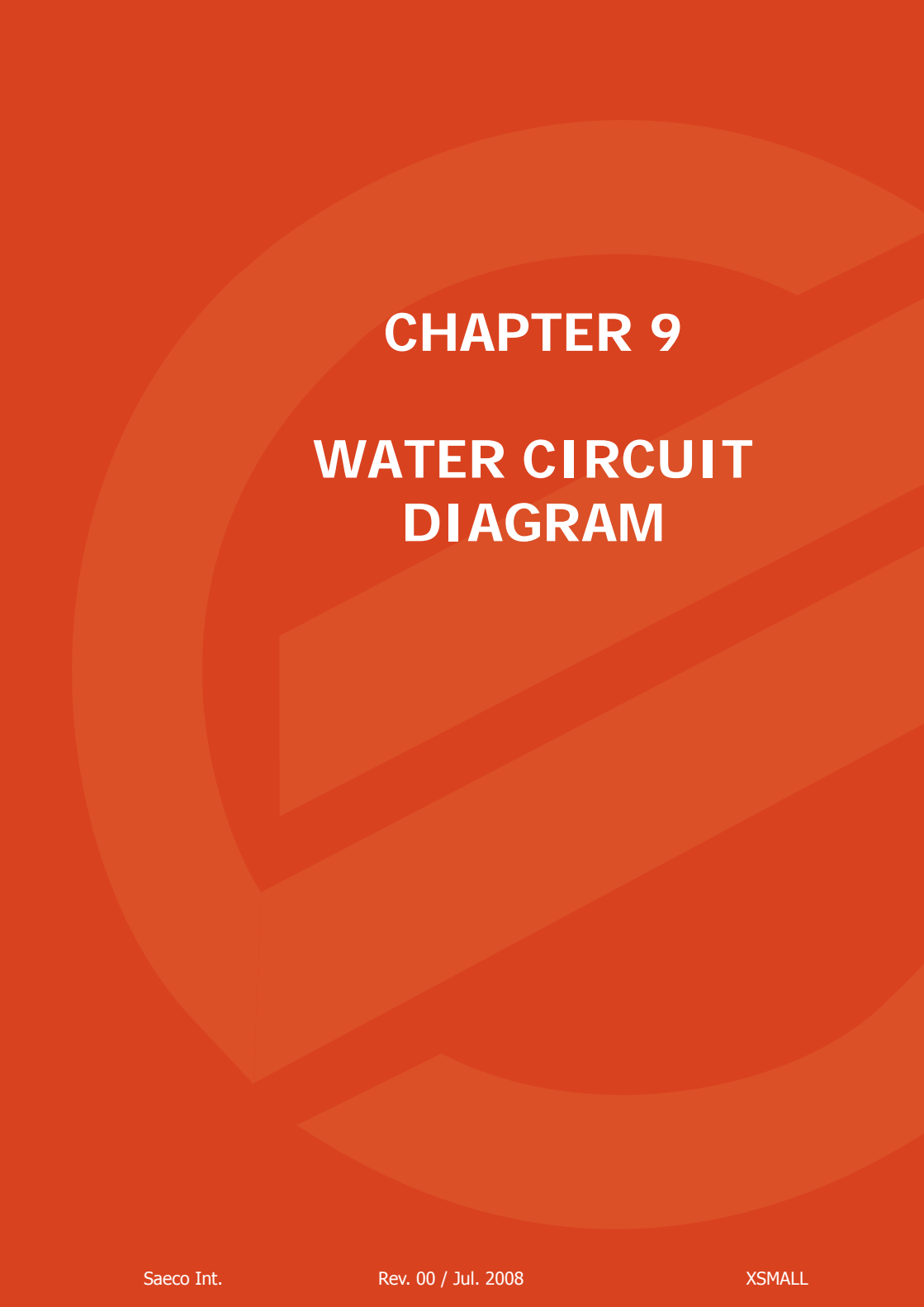

CHAPTER 9

WATER CIRCUIT DIAGRAM

9.1. Water circuit diagram

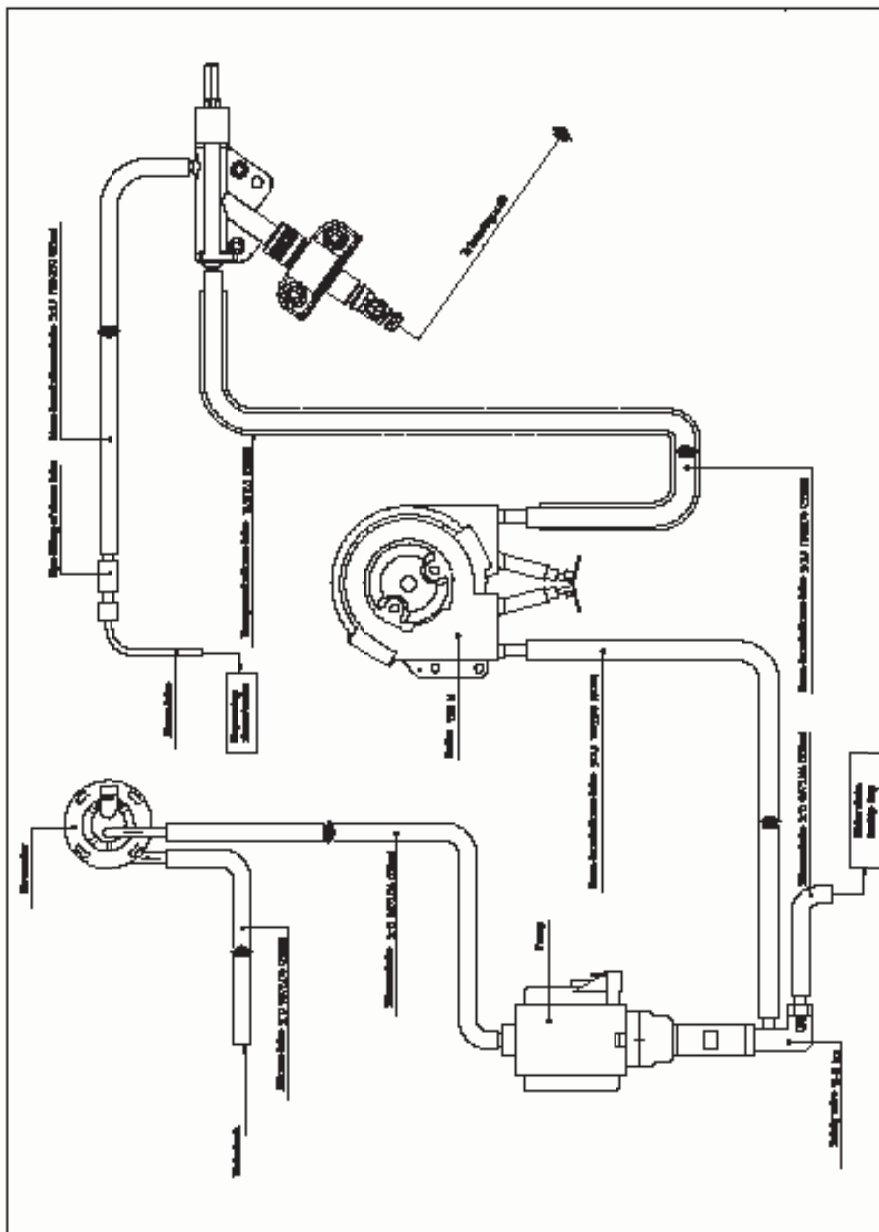

CHAPTER 10

ELECTRICAL DIAGRAM

