

Service Service Service

Intelia - Intuita



Service Manual

Rev. 04 November 2013

Table of contents	Page	Table of contents	Page
1. Introduction	4.6	Low bean level detection, dose quantity adjustment, coffee grinder blocked	
1.1. Documentation required	1	4.7. Dose self-learning (SAS)	6
1.2. Tools and equipment required	1	4.8. Water level detection (water tank)	7
1.3. Material	1	4.9. Descaling request	7
1.4. Safety warnings	1	4.10. Water filter	8
1.5. Service Policy	2	4.11. Intelia Cappuccino milk carafe	8
1.6.1. External machine parts	3		
1.6.2. Internal machine parts	4	5. Troubleshooting	
		5.1.1. Intelia Cappuccino test mode	1
2. Technical specifications		5.1.2. Intelia Focus and Class Test mode	6
2.1. Technical specifications	1	5.1.3. Intelia Latte test mode	11
2.2. Specification for the measurement of the coffee products temperature	2	5.1.4. Intuita test mode	16
2.3. Machine parameters and performance	3	5.2. Error messages	22
3. User instructions		6. Standard checks	
3.1. Intelia Cappuccino customer and programming menu	1	6.1. Repair schedule	1
3.2. Intelia Latte customer and programming menu	3	6.2. Service schedule	1
3.3. Intelia Focus and Class customer and programming menu	6	6.3. Final test	2
3.4. Intuita customer and programming menu	8		
3.5. Operation, cleaning and maintenance	10	7. Disassembly	
		7.1. Intelia Cappuccino outer Shell	1
4. Operating logic		7.2. Intellia Class and Focus outer Shell	2
4.1. Water circuit	1	7.3. Coffee grinder	2
4.2. Coffee cycle	3	7.4. Grinder blades	3
4.3. Single microswitch	4	7.5. Coffee grinder adjustment	4
4.4. Temperature sensor	4	7.6. Intelia Cappuccino three-way solenoid valve	4
4.5. Coffee grinder	5	7.7. Intelia Class and Focus two-way solenoid valve	5
		7.8. Two-way solenoid valve (V2)	5
		7.9. Intelia Cappuccino carafe fitting body	5

All parts of this document are the property of Saeco International Group.

All rights reserved. This document and all the information herein is provided without liability deriving from any errors or omissions. Furthermore, no part may be reproduced, used or collected, except where express authorisation has been provided in writing or through a contractual agreement.

Table of contents		Page
7.10	Pump	6
7.11.	Flow-meter	6
7.12.	Power board	6
7.13.	Water sensor control board	6
7.14.	Gear motor	7
7.15.	Boiler	9
7.16.	Dispenser assembly	9
7.17.	Valve disassembly	9
7.18.	Control board and display	10
7.19.	Fitting and removing Oetiker clamps	11
8.	Notes	
9.	Water circuit diagram	
10	Electrical diagram	



CHAPTER 1

INTRODUCTION

1.1 Documentation required

The following documentation is needed for repair procedures:

- Instruction booklet for specific model
- Technical documentation for specific model (diagrams, exploded view, symptom cure and service manual)

1.2 Tools and equipment required

As well as the standard equipment, the following is required:

Qty.	Description	Notes
1	Screwdriver	Torx T 8 - T 10 - T 20
1	Pliers for Oetiker clamps	
1	CC -A - Vdc tester	
1	Digital thermometer	Scale limit > 150°C
1	SSC (Saeco Service Center)	Programmer (for programming and diagnostics mode)

1.3 Material

Description	Notes
Thermal paste	Heating element > 200°C
Descaler	Saeco descaler
Grease solvent	Personal choice
Silicone grease	Safe to use with food

1.4 Safety warnings

We recommend you consult the technical manual of the machine before performing any maintenance work.

Observe all applicable standards relating to the repair of electrical appliances.

Always disconnect the power plug from the mains before beginning repair work.

Simply turning off the main machine power switch is not an adequate safety precaution.

This domestic appliance is rated as insulation class I.

On completion of the repair work, insulation and dielectric rigidity tests must be performed.

1.5 Service POLICY grid as used for coffee machine

For IN WARRANTY repairs is mandatory to use the single components (not the assembly) available in the exploded views of the coffee machines or of the specific components. If you find the information "SEE THE EXPLODED VIEW E....." in the assembly description field, it means that the single components of the assembly are available in the other pages of the exploded view. It's possible to use the assembly only if there is a specific Symptom Cure that include this possibility or when the single components are not available for the order.

List of principal assembly present in all our coffee machines

Components	Assembly use	Single components available
COFFEE GRINDER	<u>Only for OOW repairs</u>	YES , to consult the specific exploded-view of the machine or of the Coffee Grinder on website
BREWING UNIT	<u>Only for OOW repairs</u>	YES , to consult the specific exploded-view of the machine or of the Brewing unit on website
BOILER	<u>Only for OOW repairs</u>	YES , to consult the specific exploded-view of the machine on website
GEAR MOTOR	<u>Only for OOW repairs</u>	YES , to consult the specific exploded-view of the machine on website
FILTER HOLDER	<u>Only for OOW repairs</u>	YES , to consult the specific exploded-view of the machine on website
MILK CARAFE	<u>Only for OOW repairs</u>	YES , to consult the specific exploded-view of the machine on website
THERMAL CARAFE	<u>Only for OOW repairs</u>	YES , to consult the specific exploded-view of the Thermal Carafe on website
MILK ISLAND	<u>Only for OOW repairs</u>	YES , to consult the specific exploded-view of the Milk Island on website

1.6.1 External machine parts

Intelcia Cappuccino

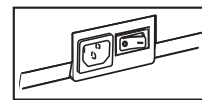
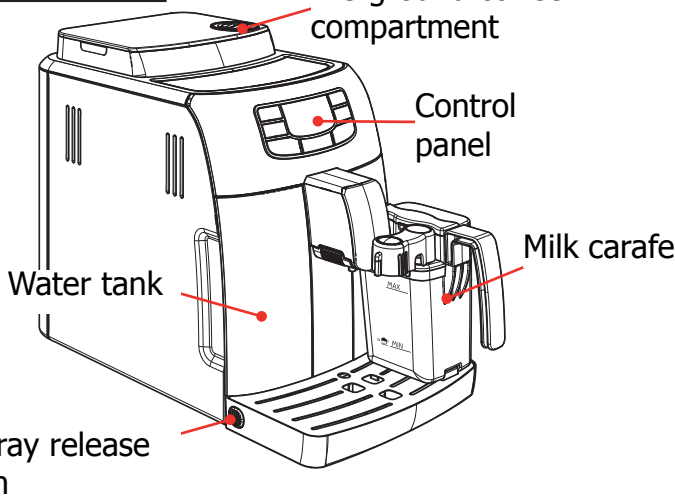
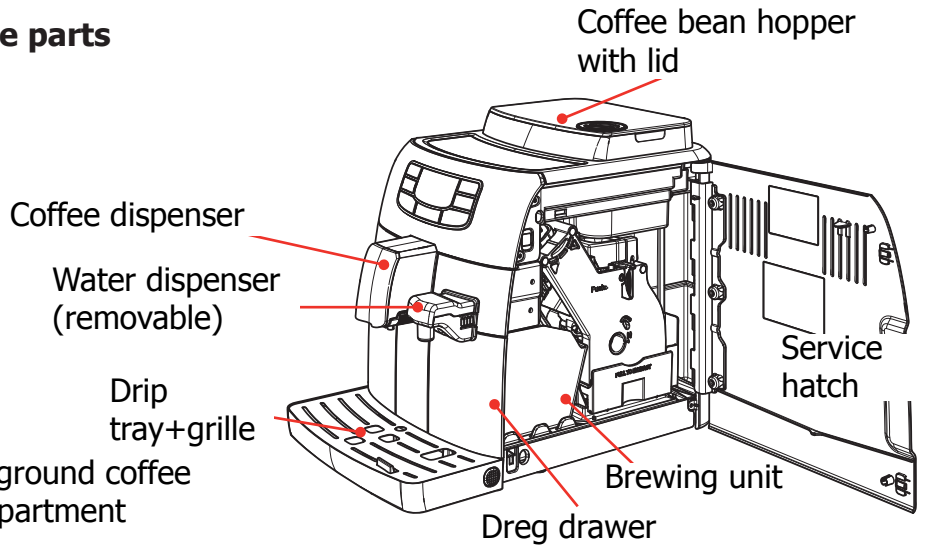
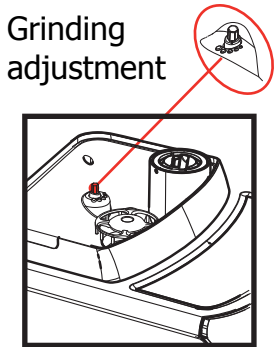

Power cable socket and main switch

- Espresso dispensing button
- Long espresso dispensing button
- Hot water/steam selection button

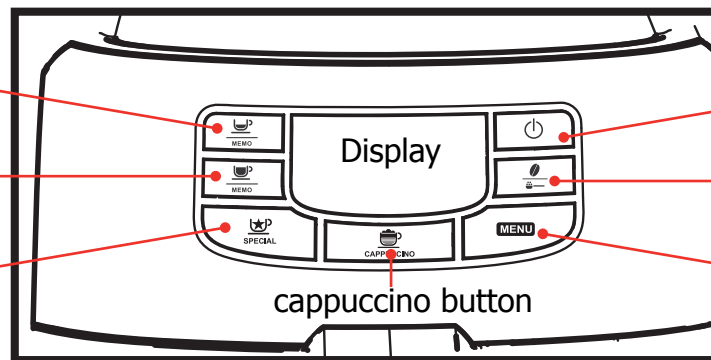

- ON/OFF button
- Aroma / Pre-ground button
- MENU button

Intelcia Latte

- Espresso coffee brew button
- Long espresso brew button
- "Aroma" - Pre-ground coffee button
- "MENU" button

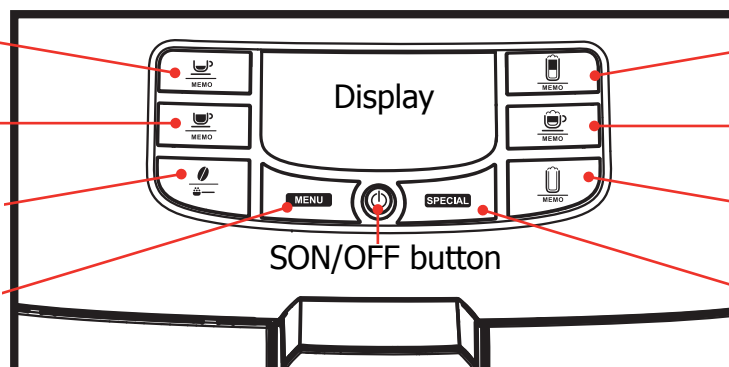

- Latte Macchiato brew button
- Cappuccino brew button
- Hot Milk brew button
- Special beverages selection button

Intelial Class e Focus

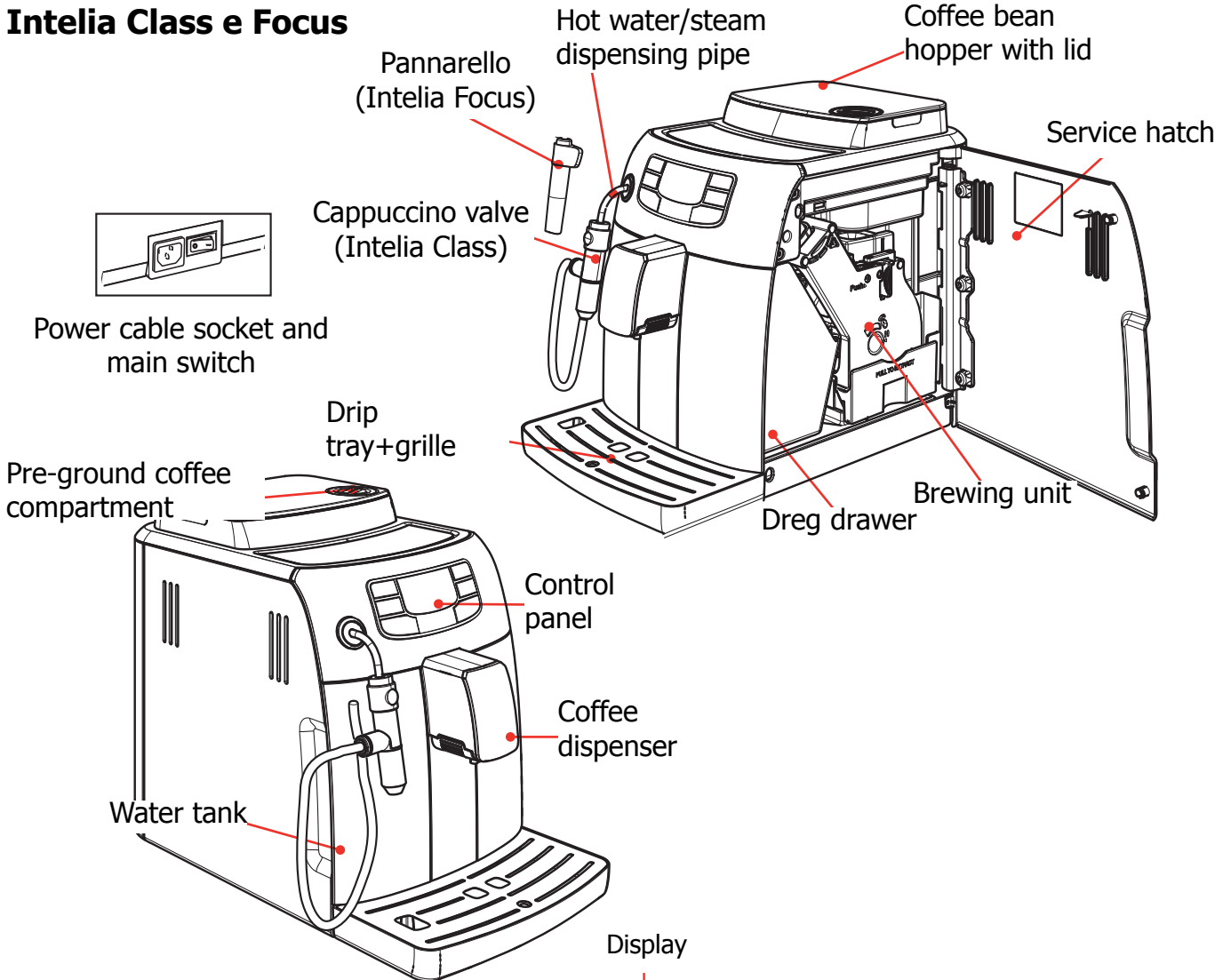

Espresso dispensing button

Long espresso dispensing button

Hot water/steam selection button

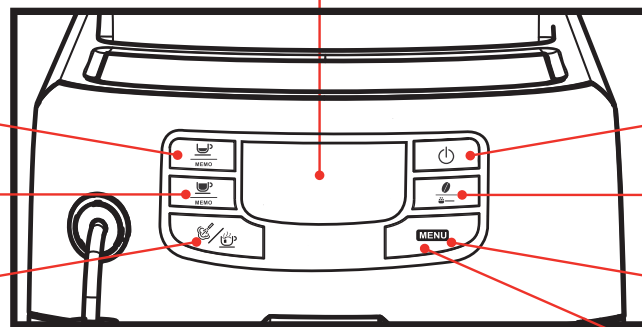

ON/OFF button

Aroma / Pre-ground button

MENU button

DESCALING button

Intelial Focus

Intuita

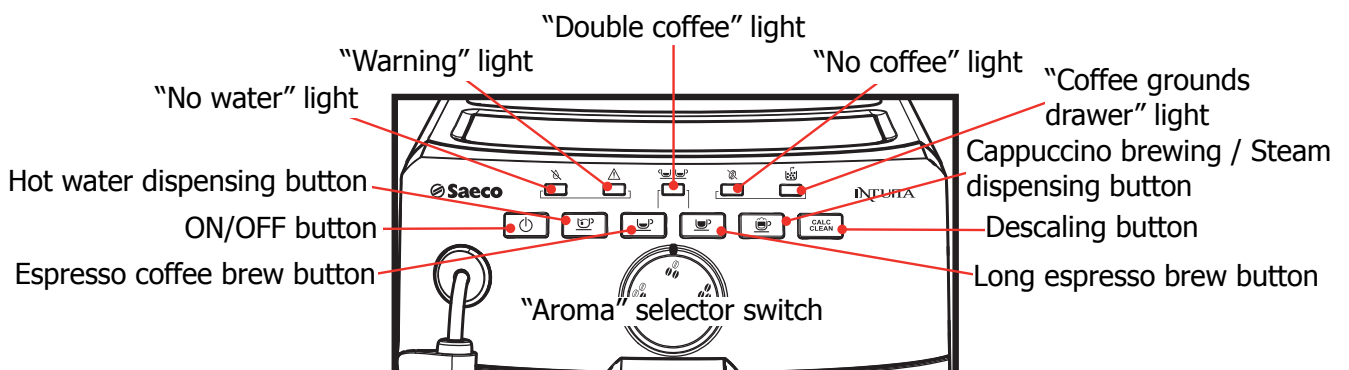

1.6.2 Internal machine parts

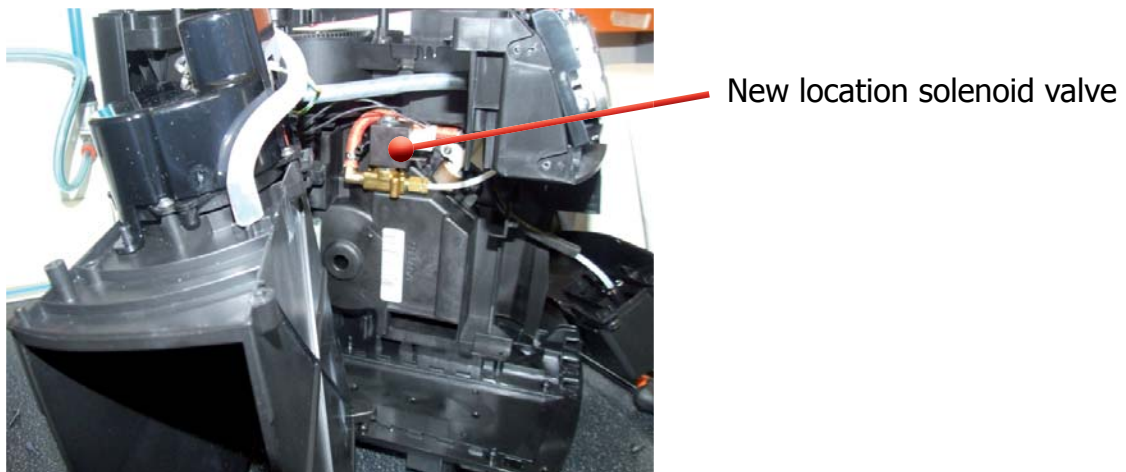
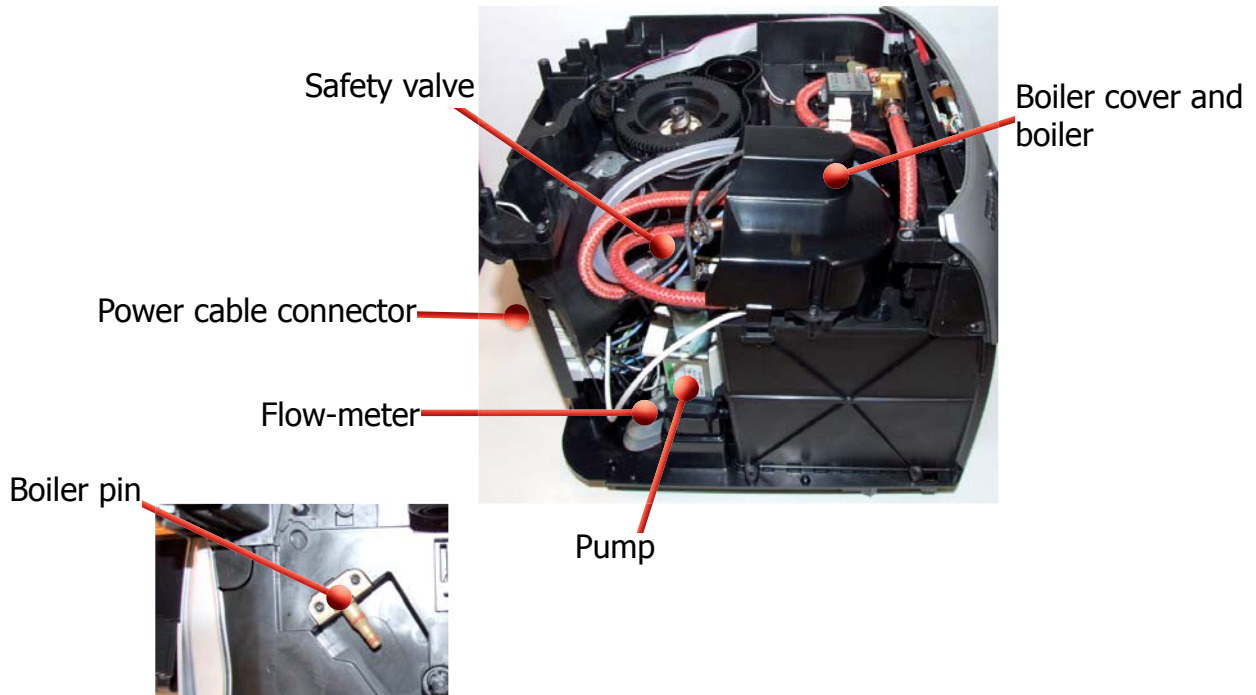
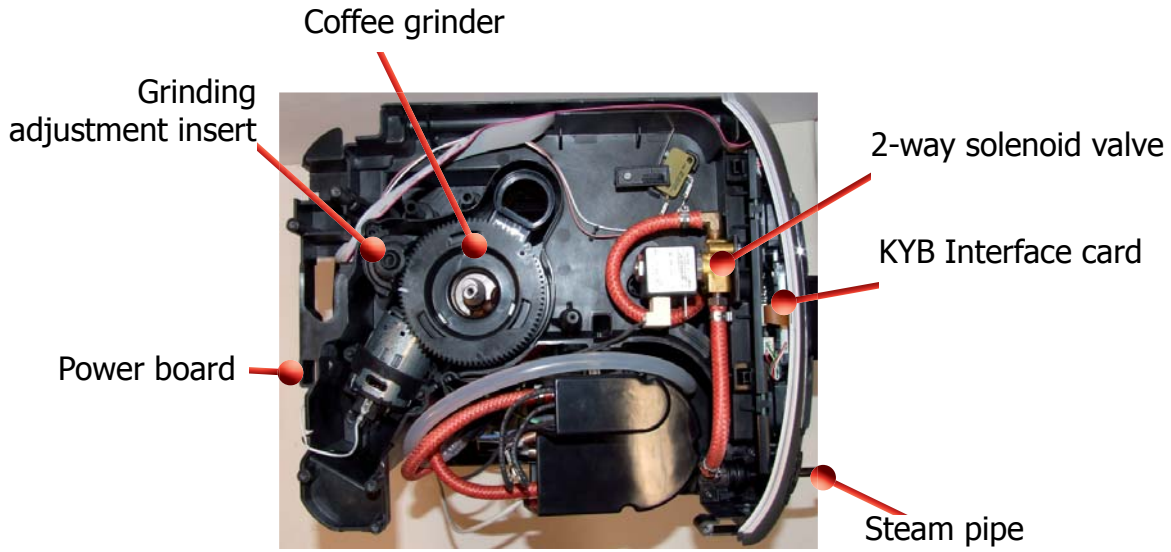



CHAPTER 2

TECHNICAL SPECIFICATIONS

2.1. Technical specifications

Power supply and output:	240 V~ 50 Hz 1850 W - 230 V~ 50/60 Hz 1850 W 120 V~ 60 Hz 1500 W - 100 V~ 50/60 Hz 1300 W
Temperature monitoring:	(NTC) variable resistor sensor - transmits the value to the electronic card
Safety system:	2 thermostats at 190°C one shot
Coffee heat exchanger output: Stainless steel	(230 V~) 1900 W for coffee, hot water and steam dispensing
Steam heat exchanger output: Stainless steel	As above
Gear motor:	2 rotation directions; power supply 24VC
Pump:	Ulka Type EP5/S GW approx. 13-15 bar with reciprocating piston and thermal switch 100°C 48 W, 230V, 50 Hz, 120V, 60Hz 100V, 50/60 Hz
Overpressure valve:	Opening at approx. 16-18 bar
Water filter:	In tank
Coffee grinder:	Direct current motor with flat ceramic grinder blades
Automatic dosage:	Dose adjustment controlled by the electronic system
Power consumption:	During heating phase- approx. 5.6 A
Dimensions: W x H x D in mm:	256x340x440
Weight:	9 kg
Water tank capacity:	1.5 l
Coffee bean hopper capacity:	300 g. of coffee beans
Dreg drawer capacity:	10
Heat exchanger capacity:	10 (11 if after 9 dregs you dispense a double espresso)
Water circuit filling time:	Approx. 15 sec Max. on first filling cycle
Heating time:	Approx. 45 sec.
Grinding time:	Approx. 8-10 sec.

2.2. Specification for the measurement of the coffee products temperature.

The temperature is influenced by the flow from the dispenser and stratification of temperatures in the glass. In order to consider these phenomena and to introduce measures that allow comparisons in controlled conditions, below guidelines must be followed:

Conditions:

- a) Water temperature in tank: 23°C (+/-2°C).
- b) It must be used a plastic cup (see picture N°1).
- c) It must be used a thermocouple thermometer (e.g. type K - see picture N°2).
- d) The coffee machine is tested without any change of parameters or calibrations, which may affect the temperature of products, so the measurement of temperature must be done with machine in default factory setting.

Procedure:

1. The temperature must be measured in the cup, immediately after dispensing. Cup has to be placed on a non-metal surface using a thermocouple thermometer.
2. The temperature in the cup is measured by immersing the probe of the thermometer up to touch the bottom. The probe then must be moved in a circular motion for 5/6 rotations. At the of the rotations, stop in the center of the cup.
3. The highest temperature measured during the rotations is the value we are searching for, and that must be reported;
4. Test measurement: from end of dispensing to the end of rotations must be completed within 12 seconds.

Limits of acceptability

The acceptance limits are divided by features and products and are the following:

Espresso Coffee Italy Q.ty 25/40 gr.

Temperature of 1st product 69°C ≤ 85°C

Temperature of 2nd product 72°C ≤ 85°C

Coffee Q.ty 70/120 gr.

Temperature of 1st product 69°C ≤ 85°C

Temperature of 2nd product 72°C ≤ 85°C



2.3. Machine parameters and performance

PRODUCT QUANTITY	Minimum quantity (Puls.)	Default quantity (Puls.)	Maximum quantity (Puls.)	User programmable	Programm. by Production / Service
Espresso	50	165	600	Yes	No
Long coffee	70	440	600	Yes	No
Pre-ground	No				
Hot water	Continues until the water supply has been exhausted (capacitive sensor)				
Steam pannarello (frother)	Continues until the water supply has been exhausted (capacitive sensor)				

RINSE	Initial rinse	Final rinse
When performed	When the machine is switched on and the boiler temperature is $\leq 50^{\circ}\text{C}$	When the machine is switched off electronically, manually or automatically after 30', if at least one coffee has been dispensed, before switching off
No. of pulses	180	80
Stopping option	Yes, by pressing any key	Yes, by pressing any key
User disable option	No	No
Production/Service department disable option	No	No
No. of pulses user adjustment option	No	No
No. of pulses Production/Service department adjustment option	No	No
Pulse range (Min. – Max.)	No	No

Descaling cycle frequency			
Hardness	Water hardness	Without water filter	With water filter
1	Soft (up to 7°dH)	240 litres (480,000 pulses)	480 litres (960,000 pulses)
2	Medium (7° - 14°dH)	120 litres (240,000 pulses)	240 litres (480,000 pulses)
3	Hard (15° - 21°dH)	60 litres (120,000 pulses)	120 litres (240,000 pulses)
4	Very hard (over 21°dH)	30 litres (60,000 pulses)	60 litres (120,000 pulses)

The default water hardness level is 4. Each litre of water corresponds to approximately 2,000 pulses.

In the machines where is not possible change the water hardness the default hardness level is 3.

INTELIA	02 TECHNICAL SPECIFICATIONS
DREG DRAWER	Description and values
Time-out for dreg drawer	5 sec.
Reset dreg counter	Dreg emptying alarm, if the dreg drawer is removed for more than 5 seconds.

STANDBY	Description and values
Inlet time (default)	30 minutes
Inlet time programmed by Production/Service	Yes
Boiler temperature during Standby	Boiler OFF

WATER TANK	Description
Water reserve (pulses) with water filter	200
Water reserve (pulses) with no water filter	200
Water reserve modifiable by Production/Service departments	No
"Fill tank" alarm	Yes
"No tray" alarm	Yes (Fill tank)
Water mains	No



CHAPTER 3

USER INSTRUCTIONS

3.1. Intelia Cappuccino customer and programming menu

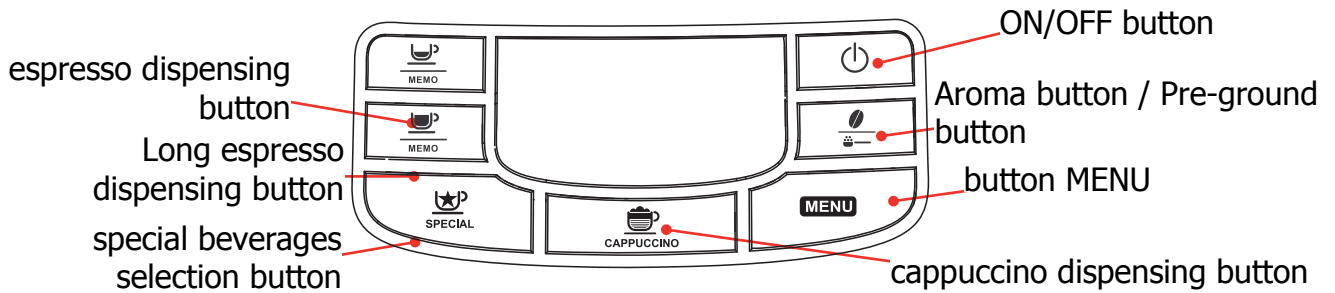

Machine ready signals (**GREEN**)

	Machine at correct temperature - for coffee bean dispensing - for hot water dispensing		Machine dispensing 1 espresso
	Machine at correct temperature - for ground bean dispensing (pre-ground)		Machine dispensing 1 coffee
	Hot water or hot milk selection		Machine dispensing 2 espresso
	Hot water dispensing		Machine dispensing 2 coffees
	Dispensing hot milk		The machine is being programmed with the coffee cup fill level
	Machine dispensing milk during the preparation of cappuccino		The machine is being programmed with the amount of milk to be dispensed to prepare cappuccino
	Machine dispensing coffee during the preparation of cappuccino		The machine is being programmed with the amount of coffee to be dispensed to prepare cappuccino

Notice signals (**ORANGE**)

	Machine in pre-heating phase for coffee, hot water and steam dispensing		Brewing unit resetting during appliance reset
	The appliance is rinsing, wait until end of operation		Fill the coffee bean container and start the dispensing cycle
	The machine signals that the "INTENZA+" filter must be replaced		Proceed to load the circuit
	If this screen appears after you switch the machine on, it means that you must run a descaling cycle. Press "MEMO" to access the descaling menu and consult the relative paragraph. Press "ON/OFF" to continue using the machine.		

Alarm signals (**RED**)

Close the service door.



Insert the dreg drawer.



No beans inside the coffee container.
After filling the container, the cycle can be restarted.



Empty the dreg drawer and the drip tray.



The Brewing Unit must be inserted in the machine.



Fill water tank.



Insert the drip tray as far as it will go.



Switch the machine off, wait for 30 seconds and switch it back on again. Repeat 2 or 3 times.
If the machine does NOT start, contact the service center.

MENU (commands and programming)

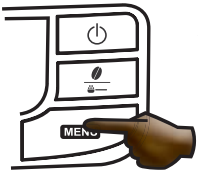

You can access the programming menu only when the machine is on.
Press the menu button to access programming.

**Coffee temperature:**

This function allows the coffee dispensing temperature to be adjusted.

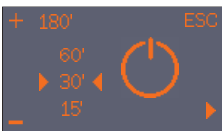
**Timer (stand-by)**

This function lets you adjust the time for switching to Stand By after the last dispensing.

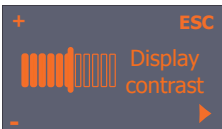
**Contrast**

This function lets you adjust the display contrast for better viewing of the messages.

**Water hardness**

This function lets you adjust the water hardness so that machine maintenance is managed better:

1 = very soft water 2= soft water 3 = hard water 4 = very hard water

**"INTENZA+" water filter**

This function lets you manage the "INTENZA+" water filter.
For details see the paragraph concerning the filter management.

**Descaling Cycle**

This function lets you execute a descaling cycle.

**Factory settings**

This function allows the factory values to be reset.

3.2. Intelia Latte customer and programming menu

Espresso coffee brew button
 Long espresso brew button
 "Aroma" - Pre-ground coffee button
 "MENU" button

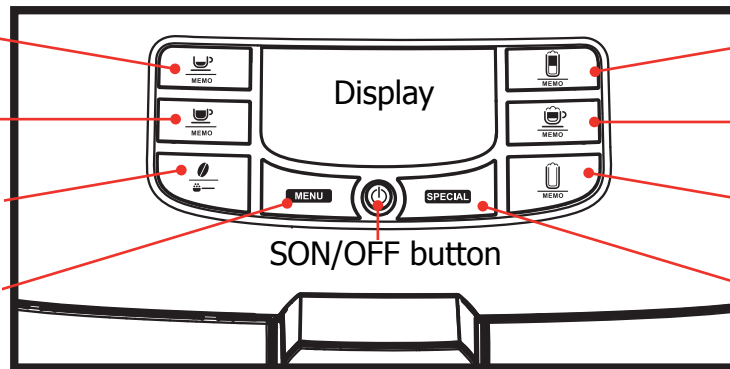

Latte Macchiato brew button
 Cappuccino brew button
 Hot Milk brew button
 Special beverages selection button

Ready signals (Green Colour)



The machine is ready to brew coffee.

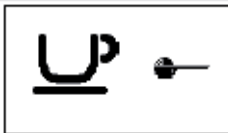

The machine is ready for brewing coffee by using preground coffee.



The machine is brewing 1 cup of espresso coffee.



The machine is brewing 1 cup of long espresso.



The machine is brewing 2 cups of espresso coffee.



The machine is brewing 2 cups of long espresso.

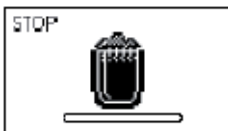

Hot milk brewing.



Milk dispensing phase during cappuccino preparation.



Coffee brewing phase during cappuccino preparation.

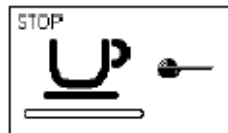

The machine is brewing 1 cup of espresso coffee by using ground coffee.



Milk dispensing phase during the preparation of the Latte Macchiato.



Coffee brewing phase during the preparation of the Latte Macchiato.



The machine is programming the amount of coffee to be brewed.



The machine is programming the amount of milk to be dispensed in order to prepare a cappuccino.



The machine is programming the amount of coffee to be brewed in order to prepare a cappuccino.



The machine is programming the amount of milk to be dispensed in order to prepare a hot milk.



The machine is programming the amount of milk to be dispensed in order to prepare a Latte Macchiato.

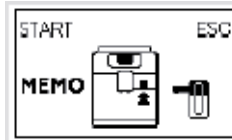

Insert the milk carafe and press the "MEMO" button to start the brewing and save. Press "MEMO" to exit.



The machine is programming the amount of coffee to be brewed in order to prepare a Latte Macchiato.



Brewing of a cup of "LIGHT ESPRESSO".



Brewing of a cup of "AMERICANO".



Hot water dispensing.



Brewing of a cup of "BABY CAPPUCCINO".

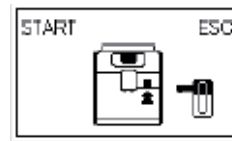

Insert the milk carafe and press the "MEMO" button to start the brewing. Press "MEMO" to exit.



Insert the water dispensing spout and press the "MEMO" button to start the dispensing. Press "MEMO" to exit.

Warning signals (Yellow Colour)

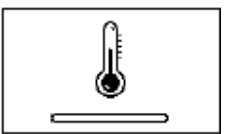

The machine is warming up to brew coffee and other products and to dispense hot water.

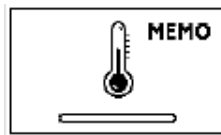

The machine is warming up to brew a product that is currently being programmed.



The Brew Group is being reset due to machine reset.

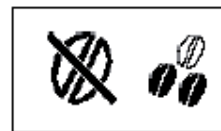

The machine is performing the rinse cycle. Wait until the machine stops the operation.



Prime the circuit.

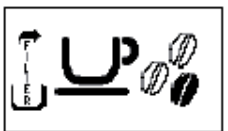

The machine needs the "INTENZA+" filter to be replaced.

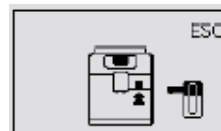

The machine reminds you to insert the carafe before going on with the descaling cycle.

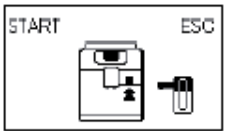

Insert the milk carafe and press the "MEMO" button to clean the carafe. Press "MEMO" to exit.

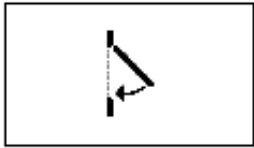

If this page is displayed after starting the machine, this means that the descaling cycle is needed. Press the "MEMO" button to enter the descaling menu and refer to the relevant section. Press the "MEMO" button to go on using the machine. Please bear in mind that failure to descale your machine will prevent it from working properly. Repair is not covered by warranty.

Warning signals (Read Colour)

Close the service door



Insert the coffee grounds drawer.



No coffee beans in the coffee bean hopper. After refilling the hopper, the cycle can be restarted.

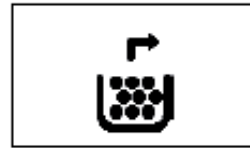

Empty the coffee grounds drawer and the liquid recovery tray.



The Brew Group must be inserted into the machine.



Fill the water tank.

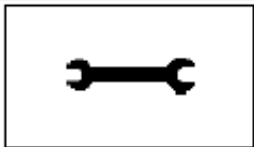

Turn off the machine. After 30 seconds, turn it on again. Try this 2 or 3 times.

If the machine does not start, contact the consumer care help line at the phone number listed on the last page of this document.



Insert the drip tray until it locks into place.

3.3. Intelia Focus and Class customer and programming menu

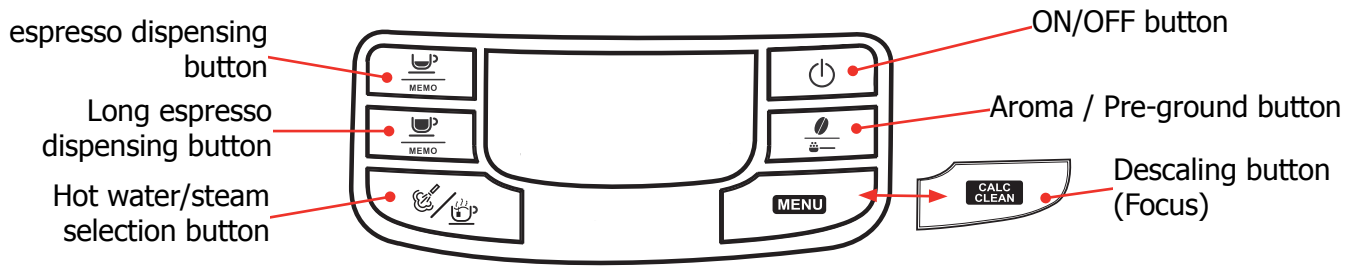

Machine ready signals (**GREEN**)

	Machine at correct temperature - for coffee bean dispensing - for hot water dispensing		Machine in phase for dispensing 1 cup of espresso
	Machine at correct temperature - for pre-ground coffee dispensing		Machine in phase for dispensing 1 cup of espresso
	Hot water /steam selection		Machine in phase for dispensing 2 cups of espresso
	Water dispense pipe (spout)		Machine in phase for dispensing 2 cups of espresso
	Steam/water dispensing		The machine is being programmed with the coffee cup fill level

Notice signals (**ORANGE**)

	Machine in pre-heating phase for coffee, hot water and steam dispensing		Brewing unit resetting during appliance reset
	The appliance is rinsing - wait until end of operation		Fill the coffee bean container and start the dispensing cycle
	The machine signals that the "INTENZA+" filter must be replaced		Proceed to load the circuit

If this screen appears after you switch the machine on, it means that you must execute a descaling cycle.

Press "MEMO" to access the descaling menu and consult the relative paragraph.
Press "ON/OFF" to continue using the machine.



Alarm signals (**RED**)

Close the service door.



Insert the dreg drawer.



No beans inside the coffee container.
After filling the container, the cycle can be restarted.



Empty the dreg drawer and the drip tray.



The Brewing Unit must be inserted in the machine.



Fill water tank.

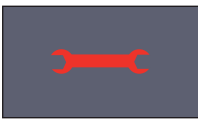

Switch the machine off, wait for 30 seconds. Repeat 2 or 3 times.
If the machine does NOT start, remove brewing unit, clean it, grease it and re-insert.
If the problem persists contact the service center.

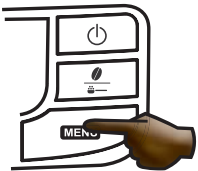
MENU (commands and programming)

The programming menu can be accessed only when the machine is switched on.
Press the menu button to access the programming menu.

**Coffee temperature (only Class)**

This function allows the coffee dispensing temperature to be adjusted.

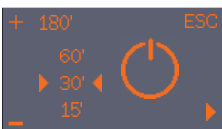
**Timer (stand-by) (only Class)**

This function lets you adjust the time for switching to Stand By after the last dispensing.

**Contrast (only Class)**

This function lets you adjust the display contrast for better viewing of the messages.

**Water hardness (Focus and Class)**

This function lets you adjust the water hardness so that machine maintenance is managed better:

1 = very soft water 2 = soft water 3 = hard water 4 = very hard water

**"INTENZA+" water filter (Focus and Class)**

This function lets you manage the "INTENZA+" water filter.

For details see the paragraph concerning the filter management.

**Descaling Cycle (Focus and Class)**

This function lets you execute a descaling cycle.

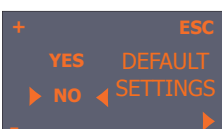
**Factory settings (only Class)**

This function allows the factory values to be reset.

3.4. Intuita customer and programming menu

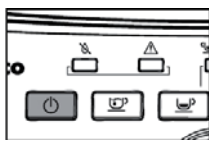
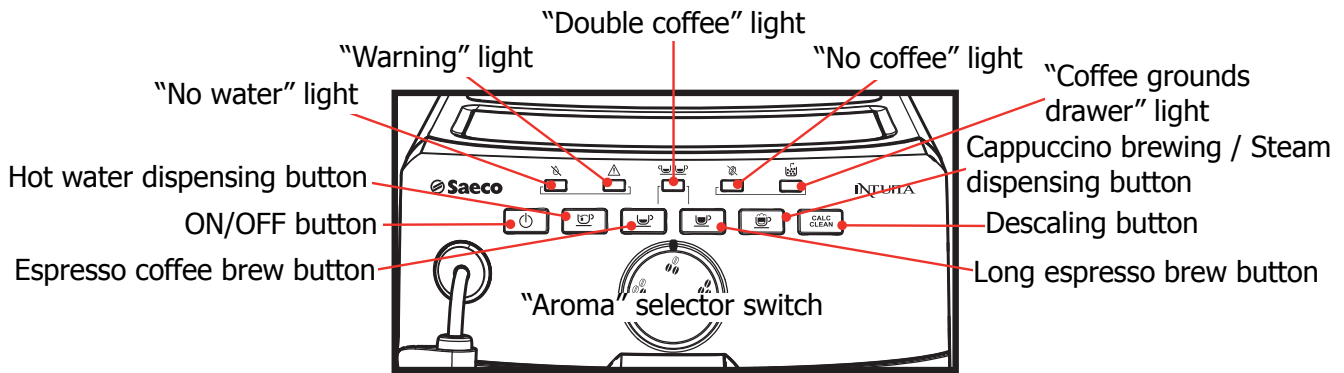

BLINKING
Machine in Stand-by.

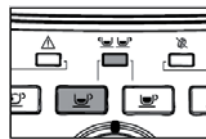

STEADY ON
The machine is brewing 2 cups of espresso coffee.

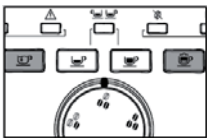

BLINKING
The machine is performing the rinse cycle.

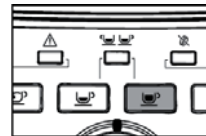

STEADY ON
The machine is brewing 1 cup of coffee.

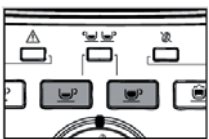

BLINKING
The machine is in the warm-up phase.

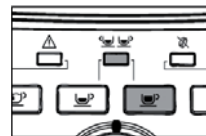

STEADY ON
The machine is brewing 2 cups of coffee.

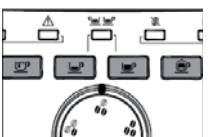

STEADY ON
The machine is ready for use.

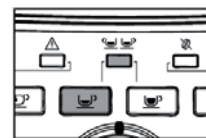

BLINKING
The machine is reprogramming the amount of coffee necessary to brew a cup of espresso coffee.

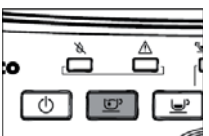

STEADY ON
Hot water is being dispensed.

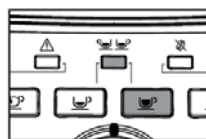

BLINKING
The machine is reprogramming the amount of coffee necessary to brew a cup of coffee.

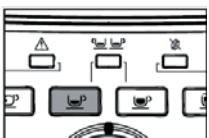

STEADY ON
The machine is brewing 1 cup of espresso coffee.

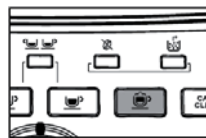

STEADY ON
Steam is being dispensed.

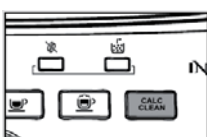

STEADY ON
The machine needs a descaling cycle. Please bear in mind that failure to descale your machine will prevent it from working properly. Repair is not covered by warranty.

Alarm signals

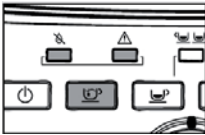

BLINKING
Prime the circuit.

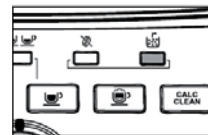

BLINKING
Insert the coffee grounds drawer.

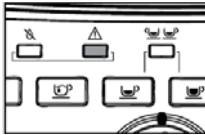

BLINKING
Close the service door. The Brew Group must be inserted into the machine.

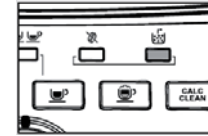

FAST BLINKING
Empty the coffee grounds drawer and the liquid recovery tray.

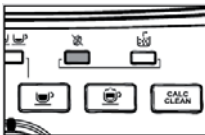

STEADY ON
No coffee beans in the coffee bean hopper. After refilling the hopper, the cycle can be restarted.

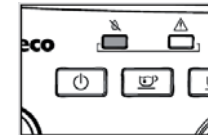

STEADY ON
Fill the water tank.

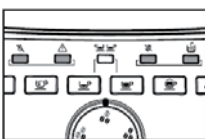

BLINKING
Turn off the coffee machine. After 30 seconds, turn it on again. Try this 2 or 3 times. If the machine does not start, contact the consumer care help line at the phone number listed on the last page of this document.

3.5. Operation, cleaning and maintenance

Operating the machine		
1	Fill water tank	
2	Fill the coffee bean hopper	
3	Switch on the appliance	
4	Press the button to start the appliance	
5	Heating	When the heating phase begins, wait for it to finish
6	Rinse	Carry out a rinse cycle for the internal circuits
7	Machine ready	The machine is ready to dispense beverages

CLEANING AND TECHNICAL SERVICING		
A	Empty the dregs drawer	When indicated
B	Empty the drip tray	As necessary
C	Clean the water tank	Weekly
D	Clean the coffee bean hopper	As necessary
E	Clean the casing	As necessary
F	Clean the brewing unit	Every time the coffee bean hopper is filled or weekly
	Lubricate the brewing unit	After 500 dispensing cycles or when the grease is no longer present on the brewing unit
	Clean the unit housing	Weekly
H	Descaling	When indicated

Descaling cycle frequency			
Hardness	Water hardness	Without water filter	With water filter
1	Soft (up to 7°dH)	240 litres (480,000 pulses)	480 litres (960,000 pulses)
2	Medium (7° - 14°dH)	120 litres (240,000 pulses)	240 litres (480,000 pulses)
3	Hard (15° - 21°dH)	60 litres (120,000 pulses)	120 litres (240,000 pulses)
4	Very hard (over 21°dH)	30 litres (60,000 pulses)	60 litres (120,000 pulses)

The default water hardness level is 4. Each litre of water corresponds to approximately 2,000 pulses.

In the machines where is not possible change the water hardness the default hardness level is 3.



CHAPTER 4

OPERATING LOGIC

4.1. Water circuit

Intelcia Cappuccino

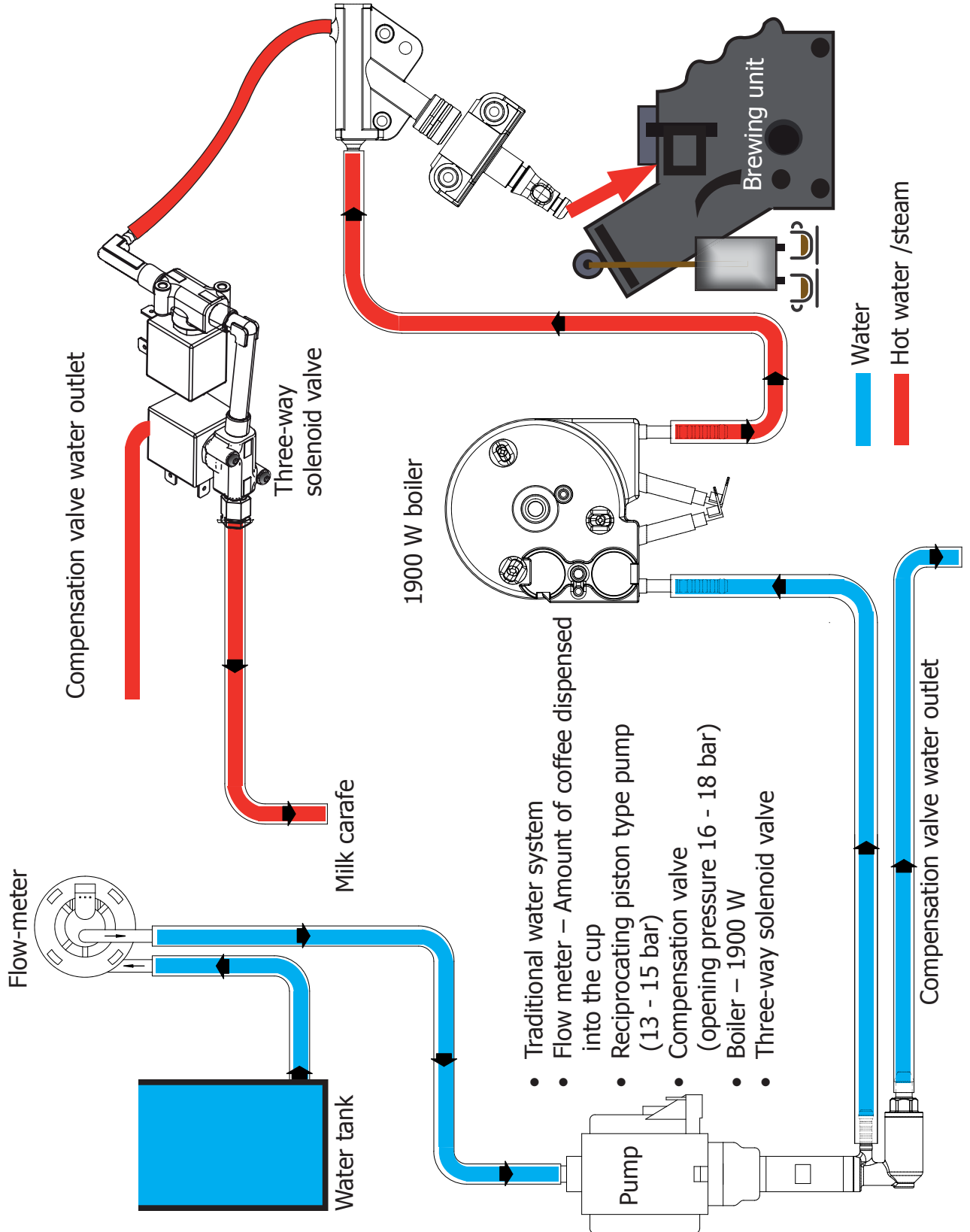

Intelial Cappuccino V2

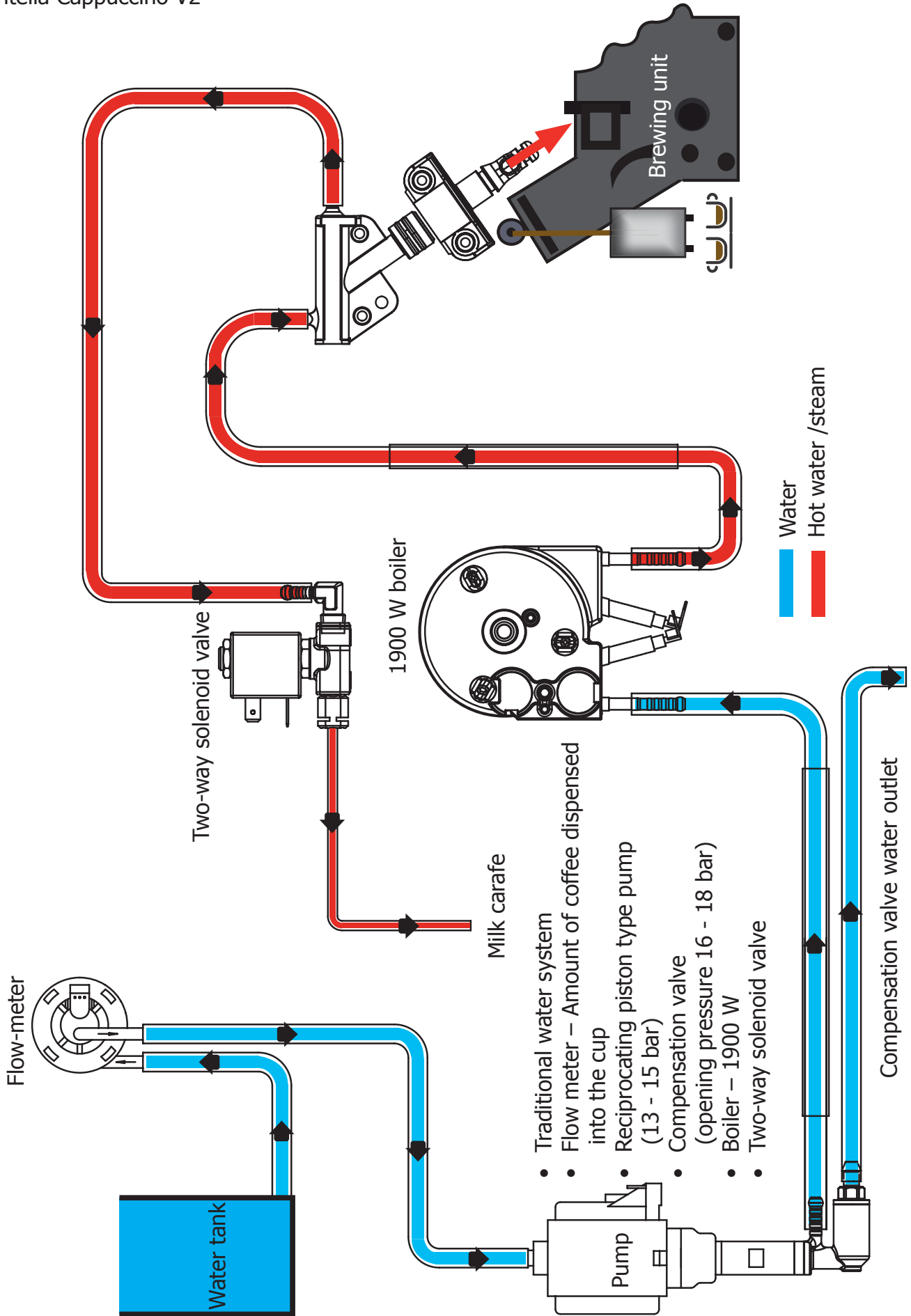

Intelia Focus e Class

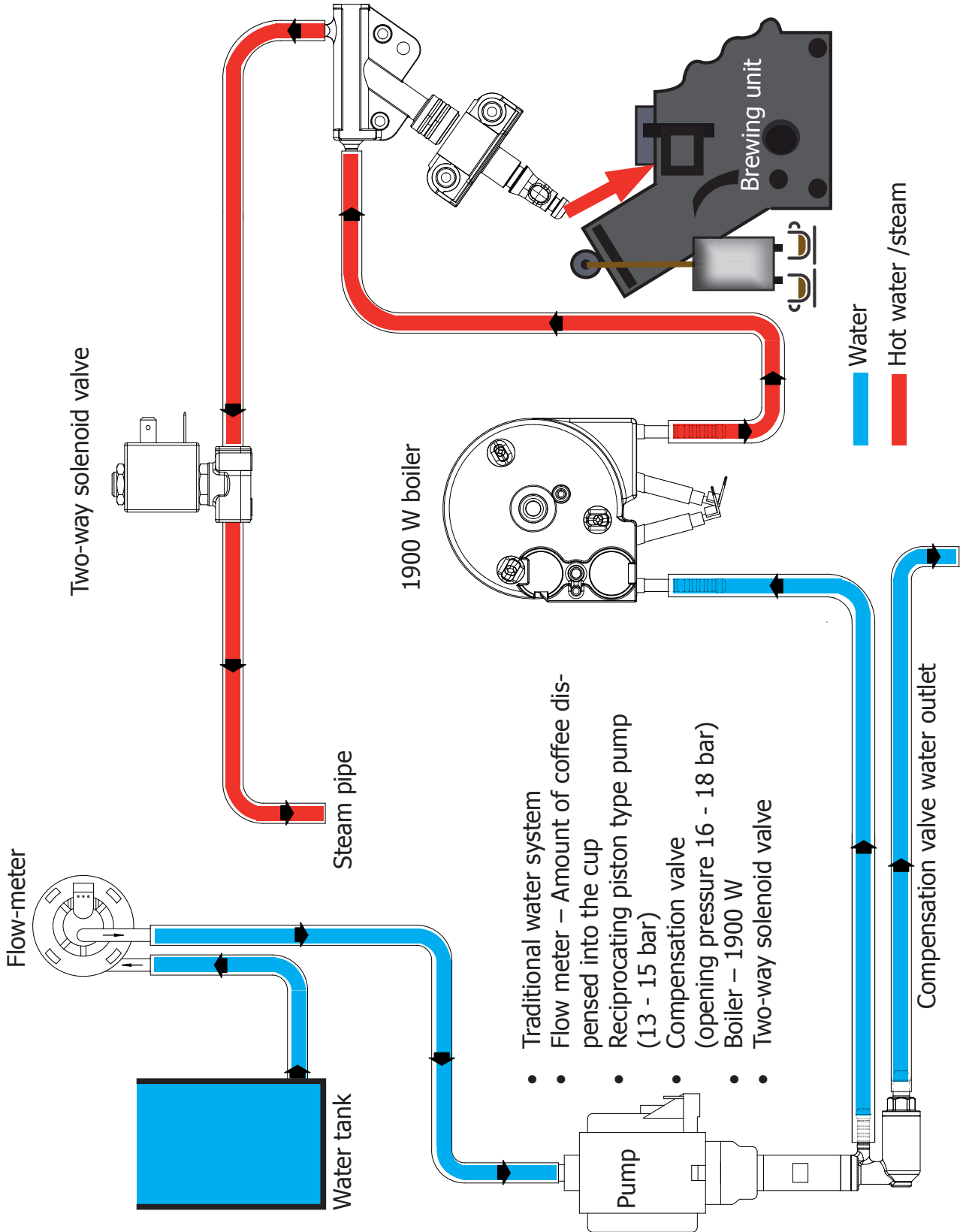

- Traditional water system
- Flow meter – Amount of coffee dispensed into the cup
- Reciprocating piston type pump (13 - 15 bar)
- Compensation valve (opening pressure 16 - 18 bar)
- Boiler – 1900 W
- Two-way solenoid valve

4.2. Coffee cycle

Main switch ON	START		STOP
Time			
Coffee grinder			Pulses (Dosage)
Heating	approx. 45 sec.		
Pump			Pump operation (flow meter pulses) in accordance with the amount of product selected.
Brewing unit gear motor			*
Status	Heating	Ready	Coffee cycle

Notes: * Only with Pre-brewing



Single microswitch gear motor

Switching on

When the machine is switched on, the gear motor repositions itself as follows:

- It acts on microswitch 1 (see following chapter).
- The gear motor changes its rotation direction and moves upwards again by approx. 1-2 mm.
- The boiler begins to heat the water for approx. 45 sec., at full power, in order to reach the optimal temperature. The temperature will then remain at a constant level.

Coffee cycle

1. The coffee grinder starts the grinding process (controlled by pulses generated by a sensor).
2. The gear motor (brewing unit) moves to the brewing position.
3. Preliminary dispensing phase (short pump activity, short pause).
4. Product dispensing (the pump operation period is defined by the amount of product dispensed).
5. The gear motor moves to its home position (the dregs are expelled automatically).

4.3. Single microswitch

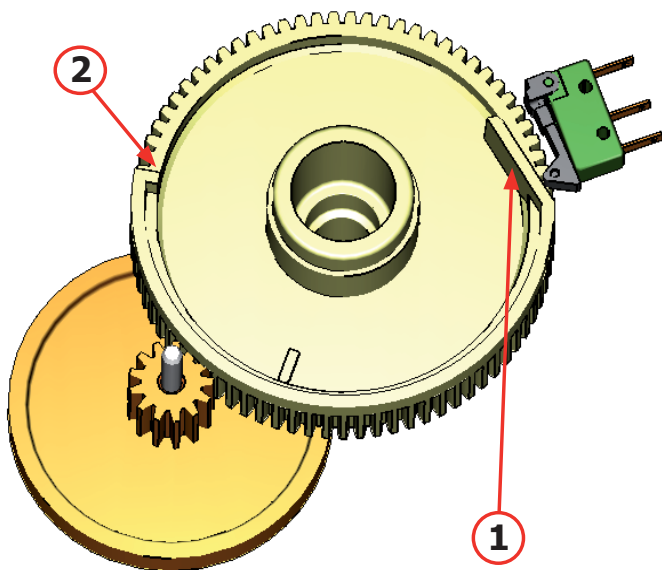

The gear motor is powered by a direct current motor that engages with the smaller double toothed wheel using a worm screw. The unit is mounted on the axle of the large gear wheel and when a coffee is requested, it moves from the standby position to the dispensing position, and then back to the standby position again.

- **Standby position: 1**

- **Dispensing position: 2**

4.4. Temperature sensor (adjustment)

Temp. (°C)	R nom (kΩ)	ΔR (+/- %)
20	61.465	8.6
50	17.599	5.9
75	7.214	4.1
80	6.121	3.7
85	5.213	3.4
90	4.459	3.1
100	3.3	2.5
125	1.653	3.9
150	0.893	5.1

An NTC is used as a temperature sensor; in the event of overheating this reduces boiler element power consumption.

The electronic system detects the current boiler temperature from the drop in voltage of the sensor and adjusts it accordingly.

Heating element values and corresponding temperatures: see table.

4.5. Coffee grinder

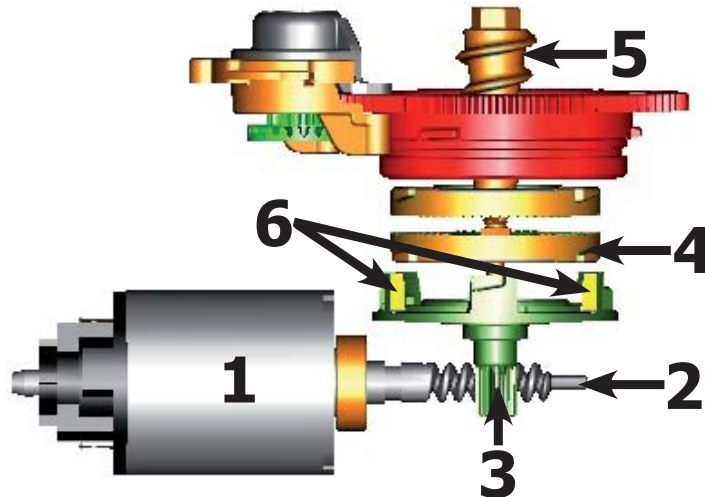

The coffee grinder is driven by a direct current motor (1) using a worm screw helicoidal wheel transmission (2).

The worm screw (2) drives a plastic gear wheel (3), which turns the lower grinder (4) and the increment pin (5)

There are two magnets (6) in the gear wheel; at every rotation these induce two pulses to a Hall sensor, which in turn transmits them to the electronic system.

4.6. Low bean level detection, dose quantity adjustment, coffee grinder blocked

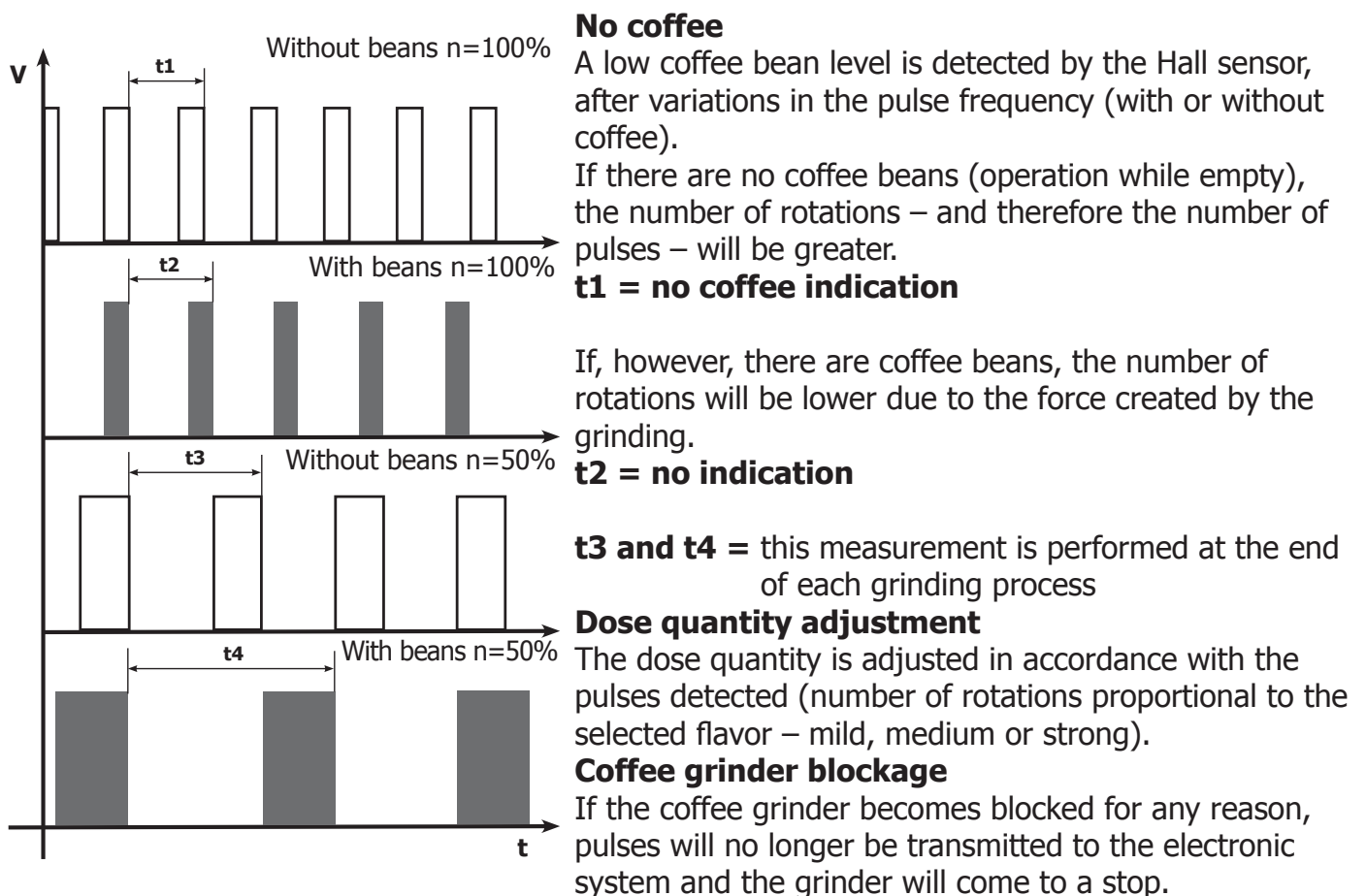

4.7. Dose self-learning (SAS)

The aim of this function is to automatically regulate the average dose of ground coffee (SELF-LEARNING); this takes place with an algorithm based on three pieces of data that the machine receives via the card:

1. Number of coffee grinder pulses during the grinding cycle.
2. Max. average value of the power consumed by the gear motor during the coffee brewing cycle.
3. Aroma selected by the user.

The algorithm compares the maximum average value of the power consumed by the gear motor with the value listed in the table for the selected aroma, in order to calculate the new grinding pulse value for the next coffee produced.

If the power consumption value is less than the minimum current value, the grinding pulses will be increased by 2.

If the power consumption value is greater than the maximum current value, the grinding pulses will be decreased by 4.

If the power consumption value falls within the "over-torque" interval, the product will be dispensed and the grinding pulses will be decreased by 10.

If the power consumption value falls within the "abort cycle" interval, the dreg will be expelled and the grinding pulses will be decreased by 10.

If the "pre-ground" flavour is selected by the user, no modification will be made.

This guarantees that, regardless of the coffee type used, the grinding level setting and the wear on the grinders, the ground coffee dose always remains constant.

Setting/Status		Power consumption in mA	Pulses corrected in the next grinding process	
			In the event of absorption above the range	In the event of absorption below the range
A	Mild aroma	200 - 300 mA	- 4	+2
B	Medium Aroma	301 - 450 mA	- 4	+2
C	Strong Aroma	451 - 600 mA	- 4	+2
D	Over-limit	601 - 800 mA	- 4	
E	Overwork	801 - 1000 mA	- 10	
F	Dreg expulsion	> 1000 mA	- 10	

Important:

For perfect operation, machine adjustment should take place in the area of the fields highlighted in green (A, B, C). When the type or brand of coffee is changed, there may be variations in the size of the beans and their stickiness or roasting level. This leads to variations in power consumption (mA), with resulting excessive or insufficient doses (until the necessary adjustments have been made to compensate for this change).

Caution: In the case of excessive dosage, powder may be expelled into the dreg drawer. This is not a fault, but can occur during preliminary operation or after a service.

4.8. Water level detection (water tank)

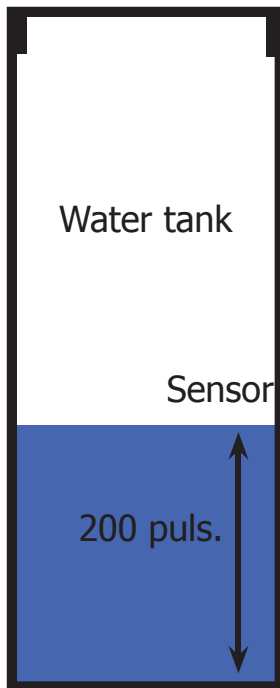

“Water low” message (water reserve)

Function:

The water level is monitored by a capacitive sensor, located one third of the way up the water tank wall.

If the electronics assembly detects, by means of the sensor, that the amount of water in the tank has dropped below the above mentioned level, a water reserve remains available for the dispensing process underway (this will cover 200 flow meter pulses).

The product dispensing process will then come to an end.

If a dispensing cycle ends after the sensor has been triggered (in the reserve) then the display “Water low” continues to be displayed during the following dispensing cycle.

4.9. Descaling request

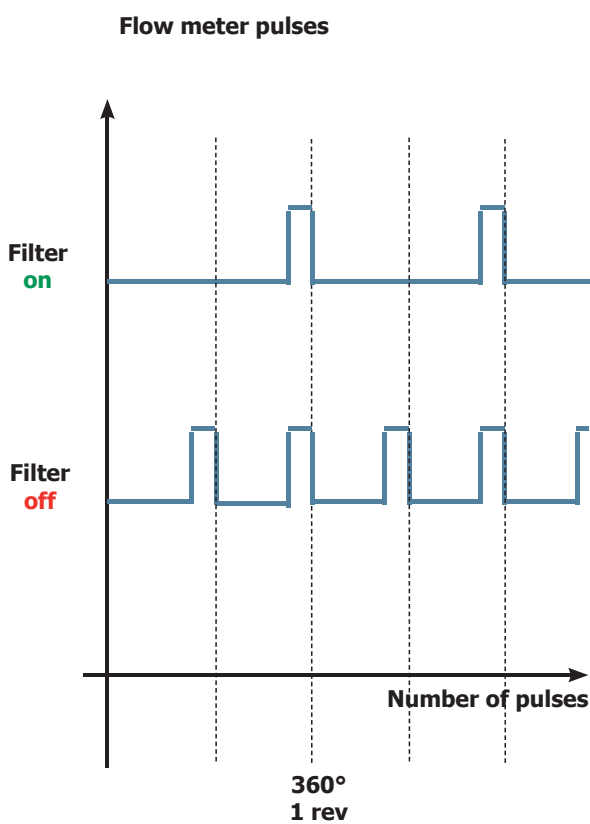

“Descaling” – message with water filter inserted

(appliances with display only)

The water hardness is set on the basis of the regional water hardness analysis (1, 2, 3, 4).

Filter off:

If the function is turned off the electronics assembly monitors the flow meter pulses, recording one pulse each turn.

Filter on:

If the function is turned on the electronics assembly monitors the flow meter pulses, recording one pulse every two turns.

“Change water filter” message

The electronics assembly uses the flow meter impulses to keep track of the amount of water which has flowed through; after the specified amount (set in accordance with the water hardness level), the “Replace filter” message appears.

4.10. Water filter

Water filter

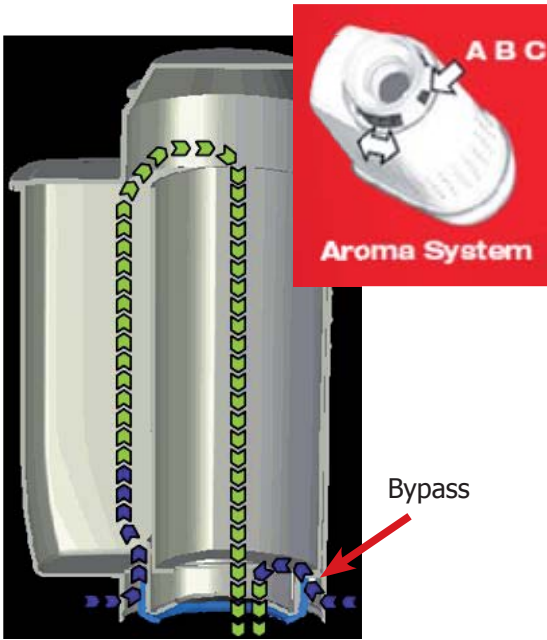

Function:

- Reduced limescale deposits which take longer to form.
- Improved water quality.
- Improved taste due to the ideal water hardness.

Life span / descaling performance:

- - 10 ° dH
- 60 litres
- 2 months

To achieve the best possible operating mode consistency over the total life span, the water is channelled using a 3-stage bypass (A, B, C) depending on the degree of hardness. See small image.

4.11. Intelia Cappuccino milk carafe



- 1) Steam input
- 2) Cappuccino maker
- 3) Bring the cappuccino maker into dispensing position before inserting the carafe in its seat
- 4) Milk tank

Emulsion chamber

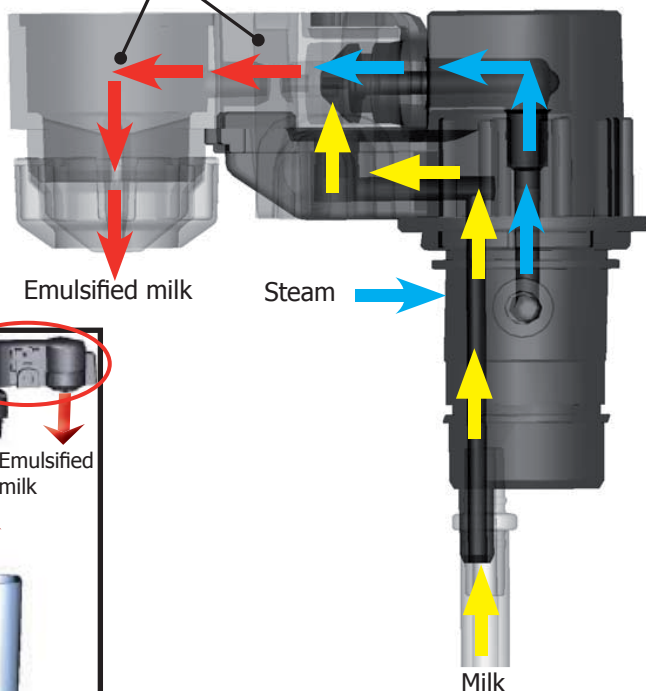

The steam passes through the pipe creating a sucking effect that pulls the milk upwards

The milk is heated by the steam and taken towards the emulsion chamber where it is mixed with air and transformed into foam

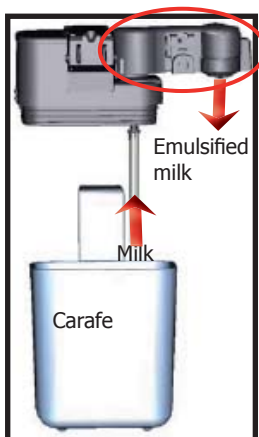



CHAPTER 5

TROUBLESHOOTING

5.1.1. Intelia Cappuccino test mode

To enter Test Mode

1. Hold down the buttons Espresso and Menu.
2. Turn on the main switch at the rear of the machine

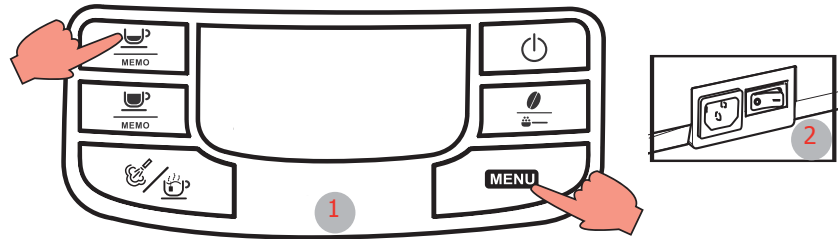

Entry into Test Mode results in a screen divided into sections, as illustrated in the diagram below.

Firmware Software version



Shows the version of the firmware loaded and the internal checksum (it gives univocal traceability)

Press STAND_BY "⏻" to move to the next screen

Operational check – keys



Initial status



The letter next to it changes from N to Y when only one button is pressed. By pressing buttons 1, 3, 4, 6 the display color changes from GREEN to RED. By pressing buttons 2, 5 and 7 the display color changes from GREEN to YELLOW.



Button 4 must be pressed at the end only once, since pressing it moves on to the next page.

ERROR condition:

The letters do not change from N to Y or are always Y, in this case check the flat communication cable with the Control Board/Power Board, if it does not change color check the cable JP4 too.

Press STAND_BY "⏻" to move to the next screen

Operational check microswitches and sensors

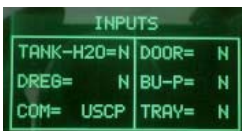

Initial status.

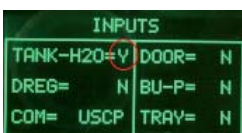

Insert full water tank

The TANK-H20 indicator must change from "N" to "Y"

ERROR Condition:

If the indication does not change, check the capacitive sensor and relative wiring (JP23).

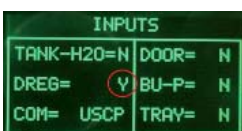

Insert the dreg drawer

The DREG indicator must change from "N" to "Y"

ERROR Condition:

If the indication does not change, check the microswitch on the dreg drawer and relative wiring (JP16).

INPUTS	
TANK-H2O= Y	DOOR= Y
DREG= Y	BU-P= N
COM= USCP	TRAY= N

Close the side door (the dreg drawer must already be in position)
The DOOR indicator must change from "N" to "Y"

ERROR condition:

If the indication does not change, check the Microswitch on the hatch and relative wiring (JP14), make sure that the dreg drawer is correctly in position.

INPUTS	
TANK-H2O= Y	DOOR= Y
DREG= Y	BU-P= Y
COM= USCP	TRAY= N

Insert the brewing unit

The BU-P indicator must change from "N" to "Y"

ERROR Condition:

If the indication does not change, check the brewing unit microswitch and relative wiring (JP16).

INPUTS	
TANK-H2O= Y	DOOR= Y
DREG= Y	BU-P= Y
COM= USCP	TRAY= Y

Insert the dreg drawer

The TRAY indicator must change from "N" to "Y"

ERROR Condition:

If the indication does not change, check the brewing unit microswitch and relative wiring (JP4).

INPUTS	
TANK-H2O= Y	DOOR= Y
DREG= Y	BU-P= Y
COM= USCP	TRAY= N

The COM indicator must be left on USCP.

Press STAND_BY "  " to move to the next screen

Operational check - milk inputs

INPUTS MILK	
CARAFE= N	TAP= N

Initial status

INPUTS MILK	
CARAFE= Y	TAP= N

Insert the Carafe

The CARAFE indicator must change from "N" to "Y"

ERROR Condition:

If the indication does not change, check the brewing unit microswitch and relative wiring (JP25).

INPUTS MILK	
CARAFE= N	TAP= Y

Insert the Water Coupling

The TAP indicator must change from "N" to "Y"

ERROR Condition:

If the indication does not change, check the brewing unit microswitch and relative wiring (JP25).

Press STAND_BY "  " to move to the next screen

Operational check – brewing unit

BU PAGE	
WORK= N	CUR= 0
HOME= N	

Initial status



Press the ESPRESSO button to move the unit to Work position. When the unit is in position, the WORK indication changes from "N" to "Y", the absorption current must be less than 200mA without the brewing unit on, and less than 300mA with the brewing unit on.



The WORK indicator remains permanently on "N"

ERROR condition:

The WORK indicator changes, and remains permanently on "N", while the backlight changes from green to red; check the microswitch, unit motor (this may be blocked) and lastly the wiring JP16 and JP14.



ERROR condition:

(without brewing unit):

If the absorbed current exceeds 200 mA the display turns red, check the gears on the motor and the motor housing in its seat.



ERROR condition:

(with brewing unit):

If the absorbed current exceeds 300 mA the display turns red, check the brewing unit, the gears on the motor and the motor housing in its seat.



Press the COFFEE button to shift the unit into Home position. When the unit reaches HOME position the indication changes from "N" to "Y", the absorption current must be less than 200mA without the unit or less than 300 mA with the unit on.



The HOME indicator remains permanently on "N"

ERROR condition:

The HOME indicator changes, and remains permanently on "N", while the display changes from green to red; check the microswitch, unit motor (this may be blocked) and lastly the wiring JP16 and JP14.



ERROR condition:

(without brewing unit):

If the absorbed current exceeds 200 mA the display turns red, check the gears on the motor and the motor housing in its seat.



ERROR condition:

(with brewing unit):

If the absorbed current exceeds 300 mA the display turns red, check the brewing unit, the gears on the motor and the motor housing in its seat.

Press STAND_BY "  " to move to the next screen

Operational check - solenoid valves and pump

EV	PUMP
EV1= OFF	IMP= 0
EV2= OFF	L/H= 0

Initial Status



If the following screen appears it means that the dreg drawer is not correctly inserted, or that the side door is not completely closed. The screen will disappear only after the drawer has been inserted or the door closed.

EV	PUMP
EV1= ON	IMP= 0
EV2= OFF	L/H= 0

Press the ESPRESSO button to activate solenoid valve EV1 (2-way, normally closed).

The solenoid valve is activated and the indication to the right of EV1 changes from "OFF" to "ON".

EV	PUMP
EV1= OFF	IMP= 0
EV2= ON	L/H= 0

Press the COFFEE button to activate solenoid valve EV2 (3-way, normally open).

The solenoid valve is activated and the indication to the right of EV2 changes from "OFF" to "ON".

EV	PUMP
EV1= ON	IMP= 106
EV2= ON	L/H= 16

Press the AROMA button to activate solenoid valve EV2 (3-way, normally open).

The water is dispensed from the steam pipe. IMP indicates an increasing number of pulses. L/H must be between 10 and 18.

EV	PUMP
EV1= ON	IMP= 0
EV2= ON	L/H= 0

ERROR:

The pulses remain at 0, the display turns red, this means there is an error in the water circuit. If water is coming out of the coupling, it means there is an error in the flow meter or in its wiring in the Control Board/Power Board (JP5). If no water is coming out, check the pump, the connected water circuit, or the pump wiring (JP24).

New version with a solenoid valve

EV	PUMP
EV1= ON	IMP= 0
EV2= OFF	L/H= 0

Press the ESPRESSO button to activate solenoid valve EV1.

The solenoid valve is activated and the indication to the right of EV1 changes from "OFF" to "ON".

EV	PUMP
EV1= ON	IMP= 0
EV2= OFF	L/H= 0

ERROR:

The pulses remain at 0, the display turns red, this means there is an error in the water circuit. If water is coming out of the coupling, it means there is an error in the flow meter or in its wiring in the Control Board/Power Board (JP5). If no water is coming out, check the pump, the connected water circuit, or the pump wiring (JP24).

Press STAND_BY "  " to move to the next screen

Operational check - coffee grinder and boiler

HEATER	GRINDER
OFF 30	0
	0 15

Initial status

HEATER	GRINDER
41	28
	0 90 17

Press Aroma to switch on the grinder

The coffee grinder starts to spin and the number of pulses is indicated by the number circled in red, the other numbers have no significance for this test.

HEATER	GRINDER
OFF 30	0 0 15

ERROR:

If the number remains 0, the display turns red, and the motor is running, the problem lies in the Hall sensors, or their wiring, or in the Control Board/Power Board input (JP2). If the motor does not run, the problem may lie in the chain (JP8), the coffee grinder wiring or the actual coffee grinder.

HEATER	GRINDER
OFF 30	0 0 15

Temperature control

The circled number expresses the boiler temperature in degrees centigrade.

HEATER	GRINDER
75 SHORT	0 0 90 18

ERROR:

If the HEATER indicator shows the word "SHORT", this means that the NTC temperature sensor is in short circuit and the display turns from green to red. In this case, check the wiring of the NTC or the Control Board/Power Board (JP13).

HEATER	GRINDER
123 OPEN	40 38 90 18

ERROR:

If the HEATER indicator shows the word "OPEN", this means that the NTC temperature sensor is disconnected, the display turns from green to red.

In this case, check the continuity of the NTC wiring and check the connection to the Control Board/Power Board (JP13).

Press the COFFEE button to activate the Boiler

The indicator changes from "OFF" to "ON" and shortly after the temperature indicator should start to increase, and any ammeter at the technician's disposal on the counter must display an absorption of approximately 8 Ampere with 230 volt.

HEATER	GRINDER
ON 49	40 15 14

ERROR:

If the temperature is not absorbed check the boiler resistor, relative wiring and the connection to the Control Board/Power Board input (JP19), also check the wiring on the NTC (JP13).

HEATER	GRINDER
OFF 137 TEMP>135!!	40 38 90 18

If the temperature goes above 125°C then the display turns yellow and an alarm message appears on the display.

Above this temperature the boiler is always off, avoiding the risk of dangerously high temperatures.

5.1.2. Intelia Focus and Class Test mode

To enter Test Mode

1. Hold down the Espresso and Menu buttons.
2. Switch on the main switch at the back of the machine.

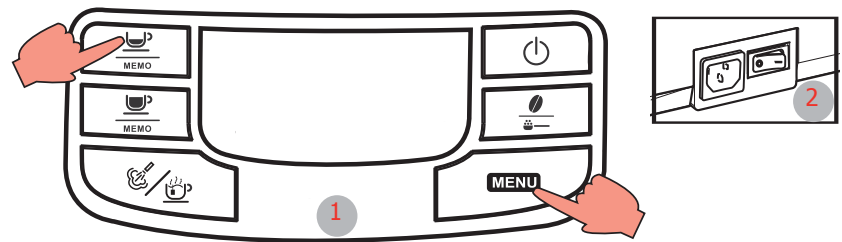

Entry into Test Mode results in a screen divided into sections, as illustrated in the diagram below.

Firmware Software version



Shows the version of the firmware loaded for Focus and Class.

Press STAND_BY "  " to move to the next screen

Operational check – keys



Initial status



The letter next to it changes from N to Y only when a button is pressed. By pressing buttons 1, 3, 4, 6 the display color changes from GREEN to RED. By pressing buttons 2, 5, the display color changes from GREEN to YELLOW. Button 4 must be pressed at the end only once as when pressed it moves to the next page.



ERROR condition:

The letters do not change from N to Y or are always Y, in this case check the flat communication cable with the power board -Power JP21, if it does not change color check the cable JP4 between the board and the display.

Press STAND_BY "  " to move to the next screen

Operational check microswitches and sensors

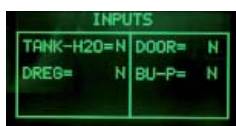

Initial status.

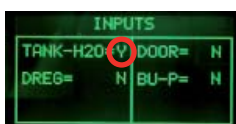

If you insert a full drip tray the TANK-H20 indicator must change from "N" to "Y".
ERROR condition:
If the indication does not change, check the capacitive sensor and relative wiring (JP23).

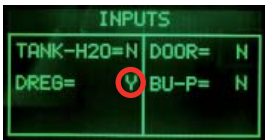

Insert grounds drawer

The DREG indicator must change from "N" to "Y"

ERROR condition:

If the indication does not change, check the microswitch on the dreg drawer and relative wiring (JP16).

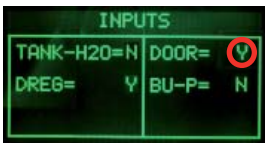

Close the side hatch (the dreg drawer must be inserted)

The DOOR indicator must change from "N" to "Y"

ERROR condition:

If the indication does not change, check the Microswitch on the hatch and relative wiring (JP14), make sure that the dreg drawer is correctly in position.

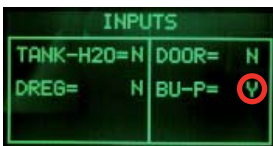

Insert the brewing unit

The BU-P indicator must change from "N" to "Y"

(this step takes 2-3 sec)

ERROR condition:

If the indication does not change, check the brewing unit microswitch and relative wiring (JP16)

Press STAND_BY "  " to move to the next screen

Operational check – brewing unit

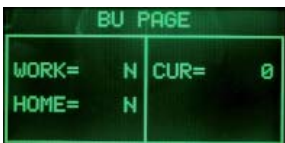

Initial status

IMPORTANT: This check can only be carried out with the dreg drawer in and the side hatch closed

Press the espresso button to move the brewing unit to the "WORK" position

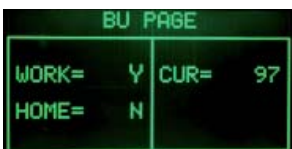

When the unit is in position, the WORK indication changes from "N" to "Y", the absorption current must be less than 200mA without the brewing unit on, and less than 300mA with the brewing unit on.

ERROR condition:

The WORK indicator always stays on "N"

ERROR:

The WORK indicator changes, and remains permanently on "N", while the display changes from green to red; check the microswitch, the motor of the gear motor (this may be blocked) and the wiring JP16.

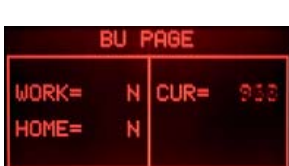

ERROR (without brewing unit):

If the absorbed current exceeds 200 mA the display turns red, check the gears on the gear motor and the motor housing in its seat.



ERROR (with brewing unit):

If the absorbed current exceeds 300 mA the display turns red, check the brewing unit, the gears on the gear motor and the motor housing in its seat.

Press the espresso button to move the brewing unit to the "HOME" position

BU PAGE	
WORK=	N CUR= 97
HOME=	Y

When the unit reaches the HOME position the indicator changes from "N" to "Y", the absorbed current, without the brewing unit, must be less than 200, and with the brewing unit less than 300 mA

ERROR condition:

The HOME indicator always stays on "N"

ERROR:

The HOME indicator changes, and remains permanently on "N", while the display changes from green to red; check the microswitch, unit motor (this may be blocked) and the wiring JP16.

BU PAGE	
WORK=	N CUR= 97
HOME=	N

BU PAGE	
WORK=	N CUR= 999
HOME=	N

ERROR (without brewing unit):

If the absorbed current exceeds 200 mA the display turns red, check the gears on the gear motor and the motor housing in its seat.

BU PAGE	
WORK=	N CUR= 999
HOME=	N

ERROR (with brewing unit):

If the absorbed current exceeds 300 mA the display turns red, check the brewing unit, the gears on the gear motor and the motor housing in its seat.

Press STAND_BY "  " to move to the next screen

Operational check - solenoid valve and pump

EV	PUMP
EV1 OFF	IMP= 0
	L/H= 0

Initial status

Press the espresso button to activate the solenoid valve

EV	PUMP
EV1 OFF	IMP= 0
CHECK DOOR	L/H= 0
AND DREGS	

If the dreg drawer is in position and the side hatch closed, the EV cannot be done. If it is not in the right position, a warning message is shown on the display, which turns yellow.

EV	PUMP
EV1 ON	IMP= 0
	L/H= 0

The indication next to EV1 changes from "OFF" to "ON". You can hear the "click" of the solenoid valve.

EV	PUMP
EV1 ON	IMP= 69
	L/H= 13

Press the aroma button to activate the pump

The water is dispensed from the steam pipe IMP indicates an increasing number of pulses. L/H must be between 10 and 18.

EV	PUMP
EV1 ON	IMP= 0
	L/H= 0

ERROR: The back-lit green display changes to red and the pulse remains 0 even if water comes out of the steam pipe, check the wiring on the flow meter (JP5). If water does not come out of the steam pipe, check the pump and the pump wiring (JP24).

EV	PUMP
EV1 ON	IMP= 0
	L/H= 0

ERROR: If L / H is 0 or very low, the solenoid valve does not open. Check the solenoid valve and the wiring (JP3).

Press STAND_BY "  " to move to the next screen

Operational check - coffee grinder and boiler

HEATER	GRINDER
OFF 30	0 0 15

Initial Status

Press the aroma button to activate the coffee grinder

HEATER	GRINDER
41	25 0 90 17

The coffee grinder starts to spin and the number of pulses is indicated by the number circled in red, the other numbers have no significance for this test.

HEATER	GRINDER
OFF 30	0 0 15

ERROR:

If the number remains 0, the display changes to red, and the motor runs, the problem lies in the Hall sensors, or their wiring, or in the CPU/POWER input (JP2). If the motor does not run, the problem may lie in the chain (JP8), the coffee grinder wiring or the actual coffee grinder.

Temperature control

HEATER	GRINDER
30	0 0 15

The circled number expresses the boiler temperature in degrees centigrade.

HEATER	GRINDER
76 SHORT	0 0 90 18

ERROR:

If the HEATER indicator shows the word "SHORT", this means that the NTC temperature sensor is in short circuit. The display changes from green to red: in this case check the wiring on the NTC or the CPU/POWER inlet (JP13).

HEATER	GRINDER
123 OPEN	40 38 90 18

ERROR:

If the HEATER indicator displays the word "OPEN", this means that the NTC temperature sensor is disconnected; the display changes from green to red; in this case check the continuity of the NTC wiring, and check the connection to the CPU/POWER in (JP13).

Press the espresso button to activate the boiler

HEATER	GRINDER
ON 49	40 15 14

The indicator changes from "OFF" to "ON" and shortly after the temperature indicator should start to increase, and the ammeter on the counter must display an absorption of approximately 8 Ampere with 230 volt.

HEATER	GRINDER
OFF 137 TEMP>135!!	40 38 90 18

There is a further check to carry out if the temperature goes above 125°C then the display changes to yellow and an alarm message appears on the display. Above this temperature the boiler is always off, avoiding the risk of dangerously high temperatures.

ERROR:

If the temperature is not absorbed check the boiler resistor, relative wiring and the connection to the CPU/POWER in (JP19), also check the wiring on the NTC (JP13).

SteamOut

To enter Test Mode

1. Hold down the Espresso and Menu buttons
2. Switch on the main switch at the back of the machine

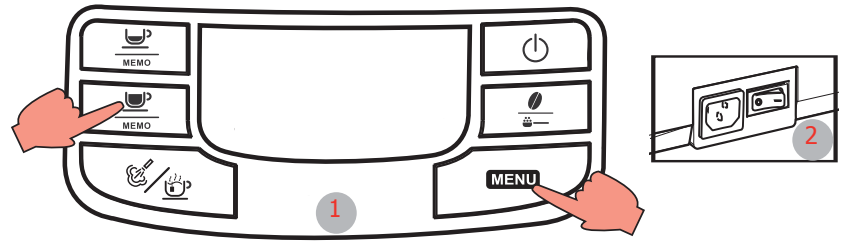

This procedure is carried out whenever you need to completely empty the residual water from the boiler.

It is recommended to carry out the SteamOut when the machine is used in places where the temperature could freeze the water inside the machine



When the machine is switched on the procedure starts; the display changes to yellow and the word "ON" indicates that the procedure is running. During the procedure the 2-way solenoid valve remains open and the steam is discharged.

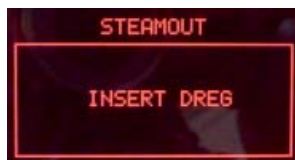

Caution!!!

If the dreg drawer is not fully in, the machine will ask you to insert it, this must be done otherwise the 2- and 3-way solenoid valves are not powered.



Caution!!!

If the side hatch opens, the machine warns you to close it, the hatch must be closed otherwise the 2- and 3-way solenoid valves will not be powered.



When the procedure is completed, the message "COMPLETE" appears on the display, the solenoid valves close automatically and the machine may be switched off.

5.1.3. Test Mode Intelia latte

To enter Test Mode

- Hold down the Espresso and Milk buttons.
- Switch on the main switch at the back of the machine.

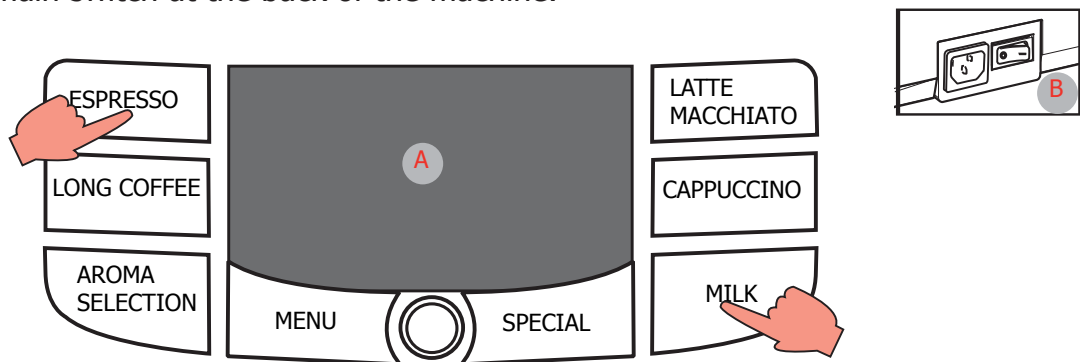

Firmware Software version



Shows the version of the firmware loaded.

Press STAND_BY "  " to move to the next screen

Operational check – keys



Initial status



The letter next to it changes from N to Y only when a button is pressed.

By pressing buttons 1, the display color changes from GREEN to RED.

By pressing buttons 2, the display color changes from GREEN to YELLOW.

By pressing buttons 3,4,5,6,7,8,9, the display color is GREEN.

Button 4 must be pressed at the end only once as when pressed it moves to the next page.

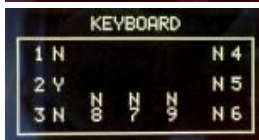

ERROR condition:

The letters do not change from N to Y or are always Y, in this case check the flat communication cable with the power board -Power JP21, if it does not change color check the cable JP4 between the board and the display.

Press STAND_BY "  " to move to the next screen

Operational check - microswitches and sensors

INPUTS			
TANK-H2O=N	DOOR=	N	
DREG=	N	BU-P=	N
COM=	USCP	TRAY=	N

Initial status

INPUTS			
TANK-H2O=	Y	DOOR=	N
DREG=	N	BU-P=	N
COM=	USCP	TRAY=	N

If you insert a full drip tray the TANK-H2O indicator must change from "N" to "Y".

ERROR condition:

If the indication does not change, check the capacitive sensor and relative wiring (JP23).

INPUTS			
TANK-H2O=N	DOOR=	N	
DREG=	Y	BU-P=	N
COM=	USCP	TRAY=	N

Insert grounds drawer

The DREG indicator must change from "N" to "Y"

ERROR condition:

If the indication does not change, check the microswitch on the dreg drawer and relative wiring (JP16).

INPUTS			
TANK-H2O=Y	DOOR=	Y	
DREG=	Y	BU-P=	N
COM=	USCP	TRAY=	N

Close the side hatch (the dreg drawer must be inserted)

The DOOR indicator must change from "N" to "Y"

ERROR condition:

If the indication does not change, check the Microswitch on the hatch and relative wiring (JP14), make sure that the dreg drawer is correctly in position.

INPUTS			
TANK-H2O=Y	DOOR=	Y	
DREG=	Y	BU-P=	Y
COM=	USCP	TRAY=	N

Insert the brewing unit

The BU-P indicator must change from "N" to "Y"

(this step takes 2-3 sec)

ERROR condition:

If the indication does not change, check the brewing unit microswitch and relative wiring (JP16)

INPUTS			
TANK-H2O=Y	DOOR=	Y	
DREG=	Y	BU-P=	Y
COM=	USCP	TRAY=	Y

Insert the brewing unit

The TRAY indicator must change from "N" to "Y"

ERROR condition:

If the indication does not change, check the brewing unit microswitch and relative wiring (JP04)

INPUTS			
TANK-H2O=Y	DOOR=	Y	
DREG=	Y	BU-P=	Y
COM=	USCP	TRAY=	N

Press STAND_BY "  " to move to the next screen

Operational check - impuls Milk

INPUTS MILK			
CARAFE=	N	TAP=	N

NOT USED

Operational check – brewing unit



Initial status

IMPORTANT: This check can only be carried out with the dreg drawer in and the side hatch closed



Press the espresso button to move the brewing unit to the "WORK" position

When the unit is in position, the WORK indication changes from "N" to "Y", the absorption current must be less than 200mA without the brewing unit on, and less than 300mA with the brewing unit on.

ERROR condition:

The WORK indicator always stays on "N"

ERROR:

The WORK indicator changes, and remains permanently on "N", while the display changes from green to red; check the microswitch, the motor of the gear motor (this may be blocked) and the wiring JP16.



ERROR (without brewing unit):

If the absorbed current exceeds 200 mA the display turns red, check the gears on the gear motor and the motor housing in its seat.



ERROR (with brewing unit):

If the absorbed current exceeds 300 mA the display turns red, check the brewing unit, the gears on the gear motor and the motor housing in its seat.



Press the coffee button to move the brewing unit to the "HOME" position

When the unit reaches the HOME position the indicator changes from "N" to "Y", the absorbed current, without the brewing unit, must be less than 200, and with the brewing unit less than 300 mA

ERROR condition:

The HOME indicator always stays on "N"

ERROR:

The HOME indicator changes, and remains permanently on "N", while the display changes from green to red; check the microswitch, unit motor (this may be blocked) and the wiring JP16.



ERROR (without brewing unit):

If the absorbed current exceeds 200 mA the display turns red, check the gears on the gear motor and the motor housing in its seat.



ERROR (with brewing unit):

If the absorbed current exceeds 300 mA the display turns red, check the brewing unit, the gears on the gear motor and the motor housing in its seat.

Press STAND_BY "  " to move to the next screen

Operational check - solenoid valve and pump

EV	PUMP
EV1= OFF	IMP= 0
EV2= OFF	L/H= 0

Initial status



If the dreg drawer is in position and the side hatch closed, the EV cannot be done. If it is not in the right position, a warning message is shown on the display, which turns yellow.

EV	PUMP
EV1= ON	IMP= 0
EV2= OFF	L/H= 0

Press the espresso button to activate the solenoid valve

The indication next to EV1 changes from "OFF" to "ON". You can hear the "click" of the solenoid valve.

EV	PUMP
EV1= OFF	IMP= 0
EV2= ON	L/H= 0

Press the coffee button to activate the solenoid valve

The indication next to EV2 changes from "OFF" to "ON". You can hear the "click" of the solenoid valve.

EV	PUMP
EV1= ON	IMP= 106
EV2= ON	L/H= 16

Press the aroma button to activate the pump

The water is dispensed from the steam pipe IMP indicates an increasing number of pulses. L/H must be between 10 and 18.

EV	PUMP
EV1= ON	IMP= 0
EV2= ON	L/H= 0

ERROR: The back-lit green display changes to red and the pulse remains 0 even if water comes out of the steam pipe, check the wiring on the flow meter (JP5). If water does not come out of the steam pipe, check the pump and the pump wiring (JP24).

New version with a solenoid valve

EV	PUMP
EV1= ON	IMP= 0
EV2= OFF	L/H= 0

Press the ESPRESSO button to activate solenoid valve EV1.

The solenoid valve is activated and the indication to the right of EV1 changes from "OFF" to "ON".

EV	PUMP
EV1= ON	IMP= 0
EV2= OFF	L/H= 0

ERROR:

The pulses remain at 0, the display turns red, this means there is an error in the water circuit. If water is coming out of the coupling, it means there is an error in the flow meter or in its wiring in the Control Board/Power Board (JP5). If no water is coming out, check the pump, the connected water circuit, or the pump wiring (JP24).

Press STAND_BY "  " to move to the next screen

Operational check - coffee grinder and boiler

HEATER	GRINDER
31	0
	90 17

Initial Status

HEATER	GRINDER
41	25
	90 17

Press the aroma button to activate the coffee grinder

The coffee grinder starts to spin and the number of pulses is indicated by the number circled in red, the other numbers have no significance for this test.

HEATER	GRINDER
OFF 30	0
	15

ERROR:

If the number remains 0, the display changes to red, and the motor runs, the problem lies in the Hall sensors, or their wiring, or in the CPU/POWER input (JP2). If the motor does not run, the problem may lie in the chain (JP8), the coffee grinder wiring or the actual coffee grinder.

HEATER	GRINDER
OFF 30	0
	15

Temperature control

The circled number expresses the boiler temperature in degrees centigrade.

HEATER	GRINDER
36 SHORT	0
	90 18

ERROR:

If the HEATER indicator shows the word "SHORT", this means that the NTC temperature sensor is in short circuit. The display changes from green to red; in this case check the wiring on the NTC or the CPU/POWER inlet (JP13).

HEATER	GRINDER
127 OPEN	40
	90 18

ERROR:

If the HEATER indicator displays the word "OPEN", this means that the NTC temperature sensor is disconnected; the display changes from green to red; in this case check the continuity of the NTC wiring, and check the connection to the CPU/POWER in (JP13).

HEATER	GRINDER
ON 49	40
	15 14

Press the coffee button to activate the boiler

The indicator changes from "OFF" to "ON" and shortly after the temperature indicator should start to increase, and the ammeter on the counter must display an absorption of approximately 8 Ampere with 230 volt.

HEATER	GRINDER
OFF 137 TEMP>135!!	40
	90 18

There is a further check to carry out if the temperature goes above 125°C then the display changes to yellow and an alarm message appears on the display. Above this temperature the boiler is always off, avoiding the risk of dangerously high temperatures.

ERROR:

If the temperature is not absorbed check the boiler resistor, relative wiring and the connection to the CPU/POWER in (JP19), also check the wiring on the NTC (JP13).

5.1.4. Intuita

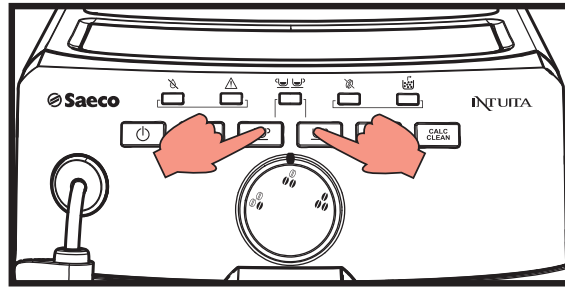

To enter Test Mode

The machine enters in test mode by pushing the ESPRESSO and COFFEE buttons and then turning ON the AC power.

As long as the buttons are pressed the machine shows LED Double Service flashing.

When the buttons are released the machine passes to the first level of the test.

There are 6 different level, in each level the coffee-machine can execute different commands

Level 0: The machine tests the LED:

- a) Turn ON every LED
- b) Turn OFF every LED
- c) Sequence turn ON every LED

Level 1: The machine tests the buttons:

- a) Button Hot Water
- b) Button Espresso
- c) Button Coffee
- d) Button Steam
- e) Button Calc Clean

Level 2: The machine tests the other input signals:

- a) Capacitive sensor in water tank
- b) Switch door close / open
- c) Switch brewing unit presence
- d) Switch dump box presence

Level 3: The machine tests the aroma trimmer:

- a) Aroma position 1 bean
- b) Aroma position 2 beans
- c) Aroma position 3 beans

Level 4: The machine tests the water circuit:

- a) EV
- b) Pump (plus flux meter)
- c) Brewing unit moves to work
- d) Brewing unit moves to home

Level 5: The machine tests the coffee powder circuit:

- a) Heater (plus NTC sensor)
- b) Grinder (plus rotation pick up)

The user can switch the level by pressing the ON/OFF button, the machine shows the level of the test:

- a) Level 1: LED No Water
- b) Level 2: LED No Water, LED Error
- c) Level 3: LED No Water, LED Error, LED Double
- d) Level 4: LED No Water, LED Error, LED Double, LED No Beans
- e) Level 5: LED No Water, LED Error, LED Double, LED No Beans, LED Dump Box

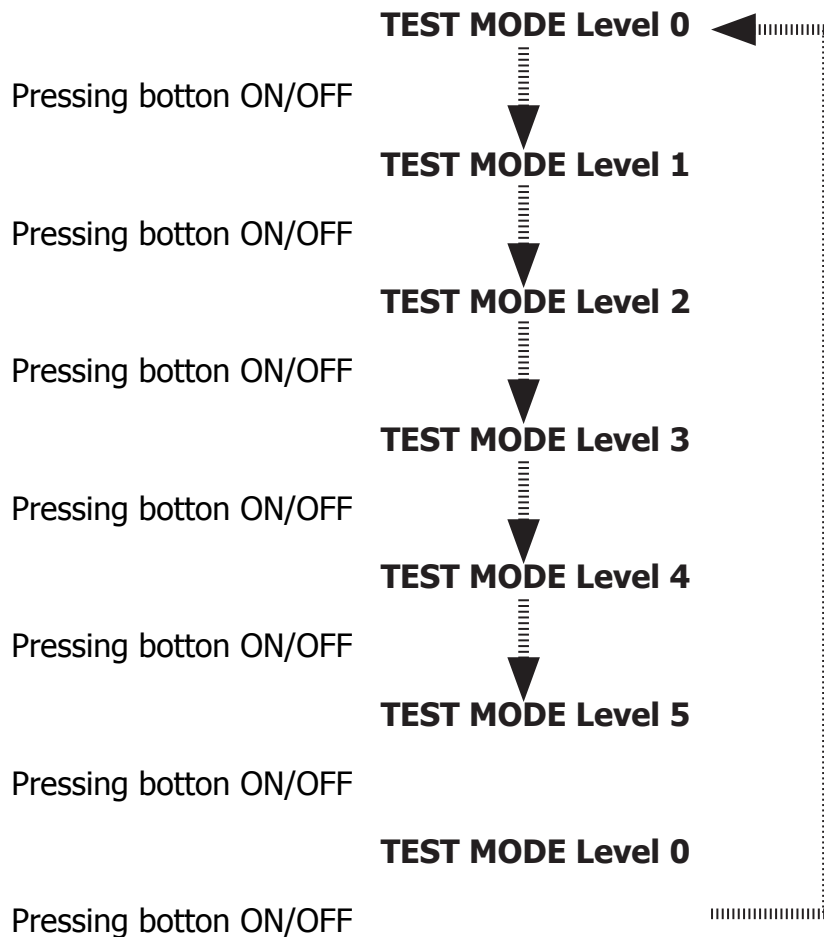

Level 0 (LED)**Description :**

Verify keyboard LED

Action :

LED ON/OFF always blink during the test.

The others LED blink once, then only one LED is ON starting from No Water, Error, Double, No Beans, Dump Box, Calc Clean, Steam, Coffee, Espresso, Hot Water.

The sequence is always repeated.

Note

LED	COLOR
No Water	RED
Error	RED
Double	GREEN
No Beans	RED
Dump Box	RED
Calc Clean	YELLOW
Steam	GREEN
Coffee	GREEN
Espresso	GREEN
Hot Water	GREEN
ON/OFF	RED

Pressing ON/OFF button moves to next level

On ERROR verify:

Cable connection

Power supply

Driver 74HC595 presence and welding

Driver 74HC595 orientation

LED presence and welding

LED orientation

Polarization resistor presence and welding

Level 1 (Buttons) [LED No Water ON]**Description:**

Verify the keyboard buttons (each button has a rear LED)

Action:

Pressing the button where the rear LED is ON changes the LED OFF, follow the moving LED

If you are not able to turn the LED OFF detects an error condition over the button switch

Start condition

All LED are OFF

Pressing ON/OFF button moves to next level

On ERROR verify:

Cable connection

Power supply

Push button presence and welding

Level 2 (switch) [LED No Water + Error ON]**Description:**

Verify the security switch connection

Action:

Mechanical move the switch and verify the relative electrical feedback

Start condition (no water tank, no BU, no dump box, door open)

All LED are blinking (because every switch is OFF)

Closing every switch turns ON the LED

Switch	LED
Water presence	hot water
BU presence	espresso
Door open	coffee
Dump box	steam

Press ON/OFF button moves to next level

On ERROR verify:

Cable connection

Power supply

Level 3 (Aroma trimmer) [LED No Water + Error + Double ON]**Description:**

Verify the aroma trimmer

Action:

Rotate aroma trimmer, 3 position 3 LED

Start condition none

Aroma	LED
1 bean	hot water
2 beans	hot water + espresso
3 beans	hot water + espresso + coffee

Press ON/OFF button moves to next level

On ERROR verify:

Cable connection

Power supply

Level 4 (Water Circuit) [LED No Water + Error + Double + No Beans ON]**Description:**

Verify the water circuit component: flux meter, pump, electro valve, brewing unit

Action:

Turn on and off actuators along water and coffee beverage circuit.

Start condition (water tank full, BU, dump box, door closed)

LED	ON/OFF	Hot water	Espresso	Coffee	Steam	Calc clean
OK	OFF	OFF	OFF	OFF	OFF	OFF

Press one time Hot Water button to open electro valve

LED	ON/OFF	Hot water	Espresso	Coffee	Steam	Calc clean
OK		ON				

Press Espresso button to turn on pump

LED	ON/OFF	Hot water	Espresso	Coffee	Steam	Calc clean
During the test			BLINK			OFF
OK			ON			OFF
ERROR (no flux meter feedback)			ON			ON

Press one time Hot Water button to close electro valve

LED	ON/OFF	Hot water	Espresso	Coffee	Steam	Calc clean
OK		OFF				

Move BU to work position. Press Coffee button to move BU to work position

LED	ON/OFF	Hot water	Espresso	Coffee	Steam	Calc clean
During the test				BLINK		OFF
OK				ON		OFF
Work position not reached				ON		ON
Overcurrent (with or without BU)				ON		BLINK

Move BU to home position. Press Steam button to move BU to home position

LED	ON/OFF	Hot water	Espresso	Coffee	Steam	Calc clean
During test					BLINK	OFF
OK					ON	OFF
Home position not reached					ON	ON
Overcurrent (with or without BU)					ON	BLINK

Move BU to rest position. Press Calc Clean button to move BU to rest position

LED	ON/OFF	Hot water	Espresso	Coffee	Steam	Calc clean
OK				BLINK	BLINK	

Press ON/OFF button moves to next level

On ERROR verify:

Cable connection

Power supply

Level 5 (Grinder & Heater)**[LED No Water + Error + Double + No Beans + Dump Box ON]****Description:**

Verify temperature increase in the heater and grinder rotation

Action:

Turn on and off actuators

Start condition (water tank full, BU, dump box, door close)

LED	ON/OFF	Hot water	Espresso	Coffee	Steam	Calc clean
OK	OFF	OFF	OFF	OFF	OFF	OFF

Press once Hot Water button to check heater NTC sensor

LED	ON/OFF	Hot water	Espresso	Coffee	Steam	Calc clean
During the test		BLINK				OFF
OK		ON				OFF
ERROR NTC open or short circuit		ON				ON

Press Espresso button to check heater power on (you need current sense / measure)

LED	ON/OFF	Hot water	Espresso	Coffee	Steam	Calc clean
OK CURRENT SENSE > 1 A			ON			OFF
Heater already hot						BLINK
ERROR CURRENT SENSE > 1 A			ON			OFF

Press Coffee button to check grinder rotation

LED	ON/OFF	Hot water	Espresso	Coffee	Steam	Calc clean
During the test				BLINK		OFF
OK				ON		OFF
No grinder rotation				ON		ON

Press ON/OFF button moves to next level (level 0)

On ERROR verify:

Cable connection

Power supply

5.2. Error codes

ERROR CODES	DESCRIPTION
01	The coffee grinder is blocked (grinder blades jammed or sensor not reading properly)
03	The brewing unit is blocked in work position (microswitch not released in up position after 3", torque error trying to move down, descent time out exceeded)
04	The brewing unit is blocked in home position (microswitch not released in down position after 3", torque error trying to move up, ascent time out exceeded)
05	Water circuit / flow meter problems (water circuit blocked or no flow meter signal)
10	Boiler temperature sensor short circuited
11	Boiler temperature sensor open circuit
14	The boiler temperature has exceeded the maximum allowed value (165°C)
15	The boiler temperature has not increased by x°C in y sec (boiler power supply disconnected, incorrect boiler fitted must be a 1300W boiler, partial power supply to boiler, cut out thermostat tripped)
19	Mains voltage trouble



CHAPTER 6

STANDARD CHECKS

6.1. Repair schedule

	Action
1	Visual inspection (transport damage)
2	Machine data check (rating plate)
3	Operational check / problem analysis
4	Opening machine
5	Visual inspection
6	Operational tests
7	Repairing the faults encountered
8	Checking any modifications (view Symptom Cure, new software, etc.)
9	Service activities in accordance with the operating schedule
10	Internal cleaning
11	Operational test while the appliance is open
12	Assembly
13	Final inspection test
14	Draining the circuit (in winter)
15	External cleaning
16	Lubricating the brewing unit with suitable grease
17	Insulation test HG 701 (dielectric)
18	Documentation

6.2. Service schedule

S Replacement

ES Visual inspection

D Descaling

P Cleaning

TR Noise test

R Adjustment

Component	Action	Support/tool
Water filter	P/S	
Water tank lip seal	S	
Boiler pin O-ring	S	
Brewing unit	ES/P	Grease solvent / Grease
Hoses, attachments and Oetiker clamps	ES	
Pump	ES/TR	
Gear motor	ES/TR	
Coffee grinder	P/R	Vacuum cleaner / brush
Water circuit	D	Saeco descaler
Hot water/steam valve	ES/S	

6.3. Final test

Test	Procedure	Support/ tool	Standard	Tolerance
Espresso	2-3 Espressos for adjustment purposes	Measuring scoop	Same amount	15%
Coffee	2-3 Coffees for adjustment purposes	Measuring scoop	Same amount	15%
Noise			Standard	
Amount of cream	Blow into the cup until the cream separates		The cream should come together again to form a complete layer	
Cream colour			Hazel brown	
Temperature	Reading taken while dispensing	Thermometer	84 °C	± 4 °C
Grinding level	Check the grain size of the ground coffee			
Hot water	Dispense water			
Steam	Dispense steam			
Dreg drawer missing indication	Remove the dreg drawer		Dreg drawer missing indication	
Low bean level indication	Start brewing a coffee while the coffee bean hopper is empty		Low bean level indication	



CHAPTER 7

DISASSEMBLY

7.1. Intelia Cappuccino outer Shell

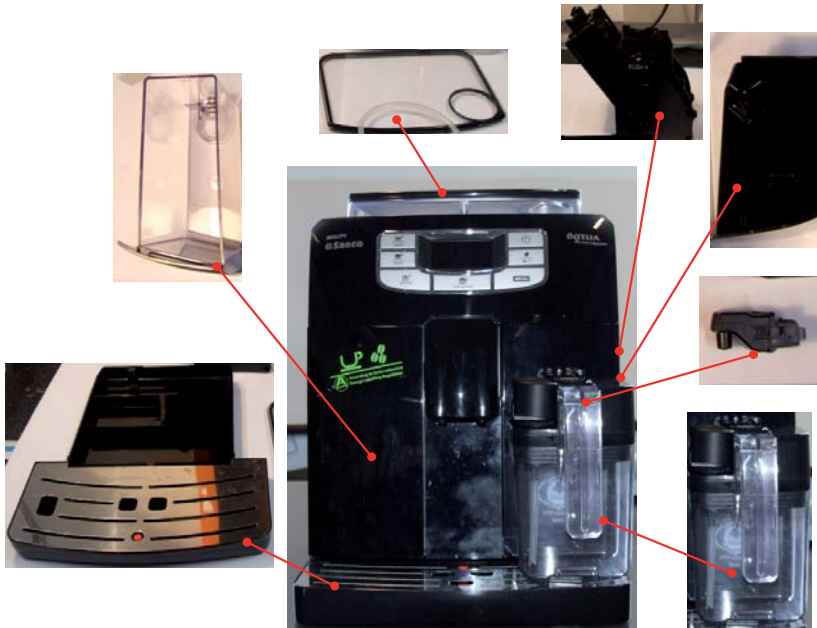

Remove the water tank, coffee container cover, drip tray, brewer/dreg drawer, brewing unit, carafe or hot water dispenser.



Unscrew the screws shown and remove the finger protection.

Lift the top cover.

Unscrew the screws shown and slide out the left side body.

Slide out the hatch.

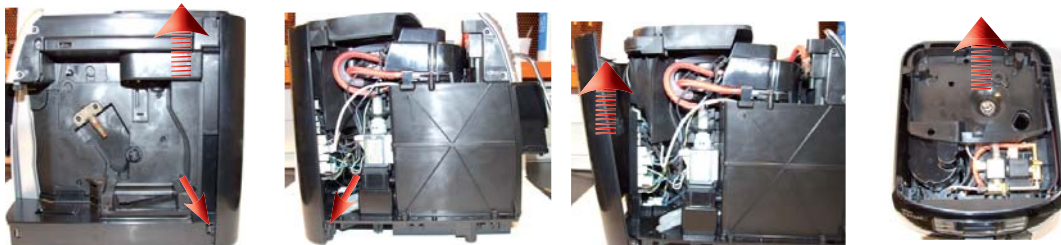

Loosen the screws as illustrated, slide out the rear body and the sound insulating cover of the coffee grinder.

7.2. Intellia Class and Focus outer Shell



Remove the water tank, coffee container cover, drip tray, brew drawer, brewing unit, cappuccino maker or pannarello.



Unscrew the marked screws and remove the finger protection.

Raise the top cover.

Loosen the screws as illustrated and remove the left side body.

Slide out the hatch.



Loosen the screws as illustrated, slide out the rear body and the sound insulating cover of the coffee grinder.

7.3. Coffee grinder

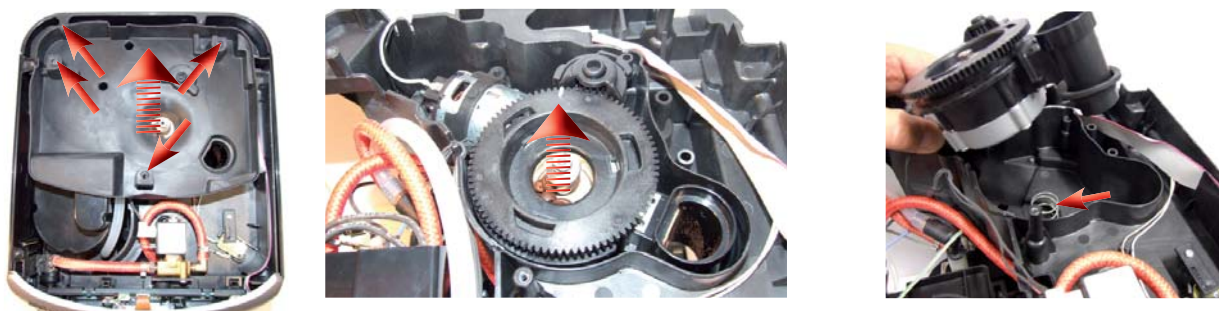

Loosen the screws as illustrated and remove the sound insulating cover. Raise the coffee grinder and remove the connections.

When reassembling the coffee grinder, make sure the spring is repositioned correctly (see photo).

7.4. Grinder blades

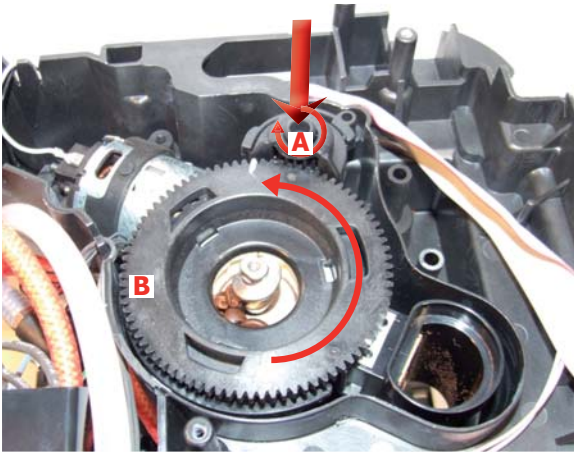

To extract the top support of the appliance, press on the grinding adjustment spindle (A) and turn the support anticlockwise until it unhooks.

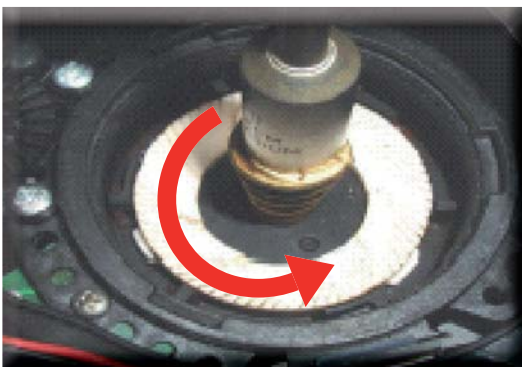

Turn the grinder blades anticlockwise out of the support.

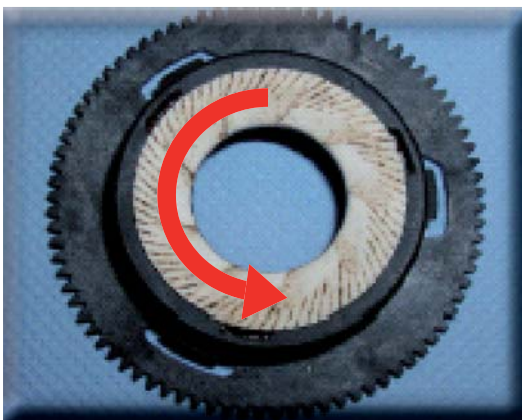

Turn the grinder blades clockwise out of the support. The bayonet connections can be accessed from the rear.

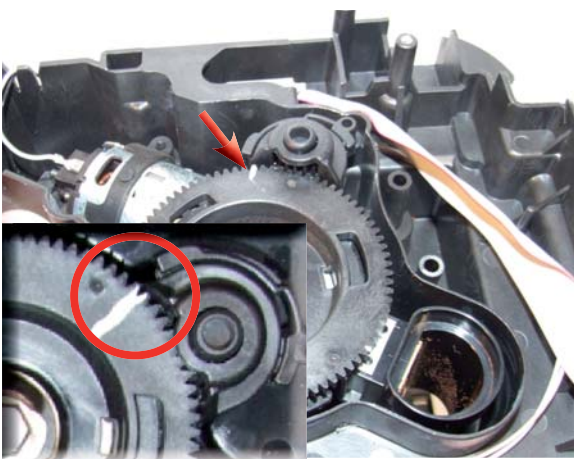

For a standard adjustment, both markings must be aligned.

7.5. Coffee grinder adjustment

The grinding adjustment can be set by the user (only with the coffee grinder in operation) by pressing and turning (only by one click at a time) the insert inside the coffee bean hopper with the aid of the wrench supplied.

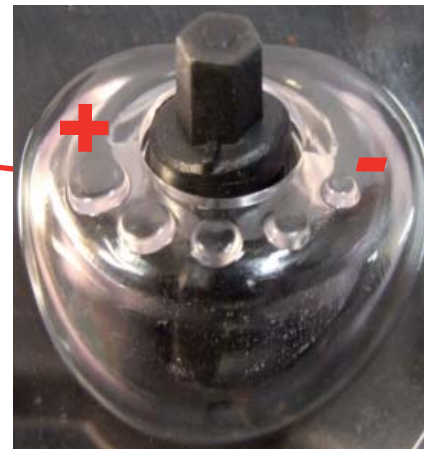

Adjustment by a service center

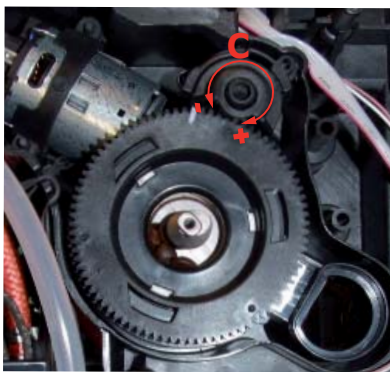

To adjust grinding further, the engineer can work directly on the coffee grinder by pressing and turning the ring nut (C) shown. (clockwise + to increase the particle size of the coffee and anticlockwise - to decrease it).

If there are any remains of coffee powder between the two grinding blades it is recommended to tighten by max. two marks at a time.

Lastly, move the arrow (A) on the adjustment knob to the center of the adjustment dots on the cover (B).

7.6. Intelia Cappuccino three-way solenoid valve

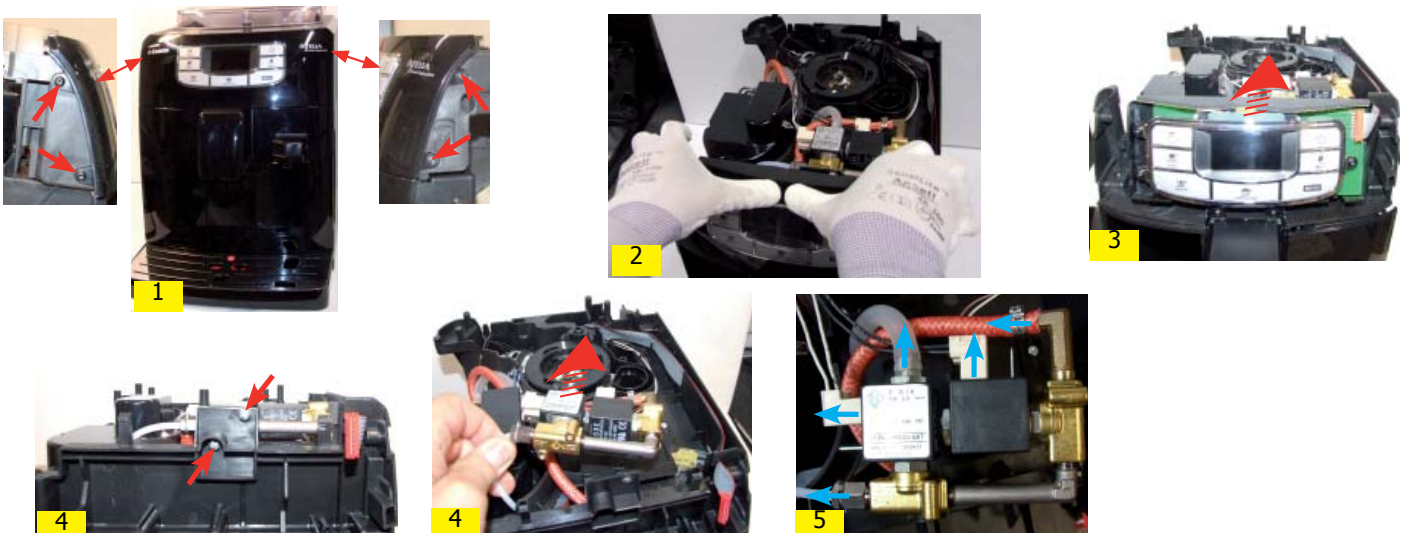

- 1) Loosen the screws highlighted
- 2) Remove the front plate, pressing it in the center and pulling the side walls outward
- 3) Remove the board support assembly
- 4) Loosen the screws holding the solenoid valve to the upper plate
- 5) Disconnect all electrical and water circuit connections

7.7. Intelia Class and Focus two-way solenoid valve

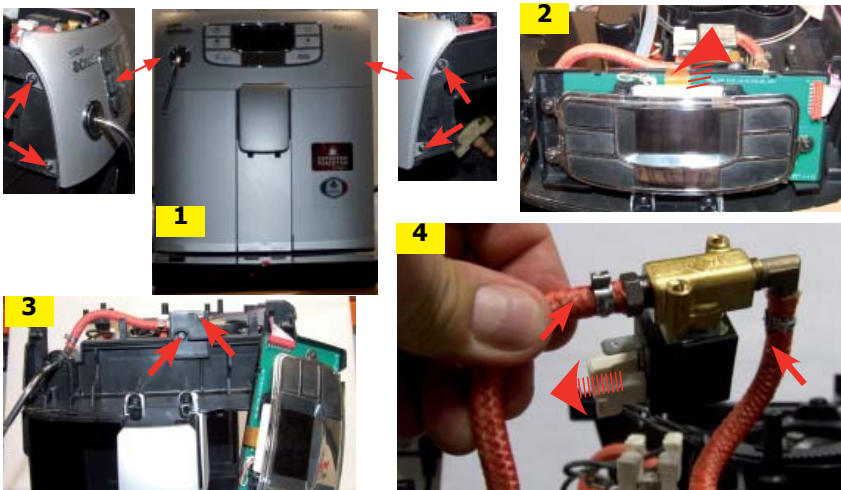

- 1) Loosen the screws highlighted.
- 2) Remove the card support assembly.
- 3) Loosen the screws holding the solenoid valve to the upper plate.
- 4) Disconnect all electrical and water circuit connections.

7.8. Two-way solenoid valve (V2)



Loosen the screws highlighted and the remove the front cover panel.

Remove the lid of the dispenser with the aid of a screwdriver



Loosen the screws as illustrated and release the insert in the bottom of the body to obtain easy access for valve disassembly

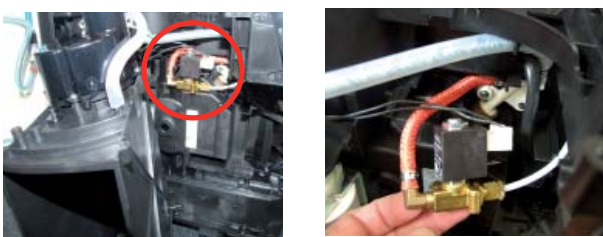

Disconnect all electrical and water circuit connections.

7.9. Intelia Cappuccino carafe fitting body

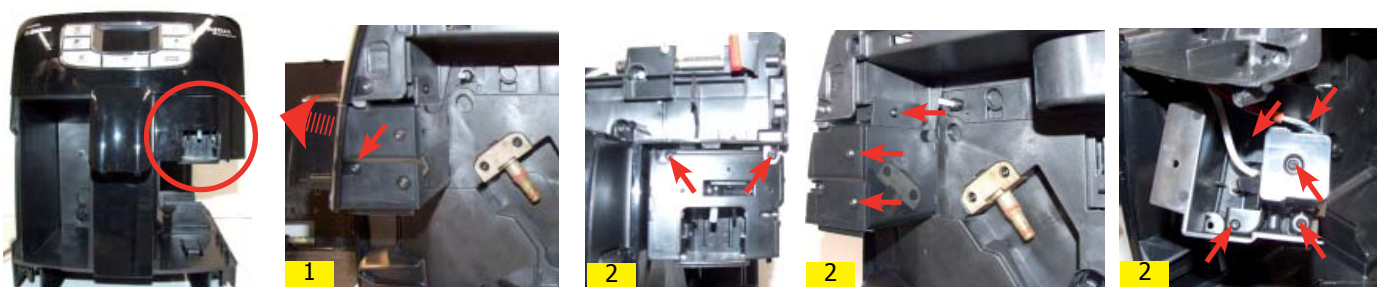



- 1) Loosen the screws holding the front cover of the carafe fitting body and release it from its seat
- 2) Loosen the screws as illustrated
- 3) Remove carafe presence sensors
- 4) Remove carafe fitting Teflon pipe

7.10. Pump

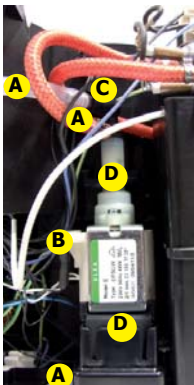

Disconnect the water circuit connections (A) and electrical connections (B), loosen the safety valve (C) and slide the pump off the brackets (D).

7.11. Flow-meter



Lift the flow meter out of the casing assembly and remove the electrical and water circuit connections.

7.12. Control board

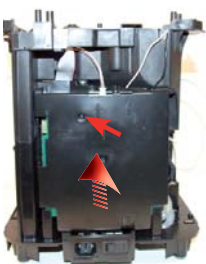

Loosen the screws as illustrated, slide out the electrical connection and remove the card guard.



Slide the card off the support and disconnect the electrical connections.

7.13. Water sensor control board

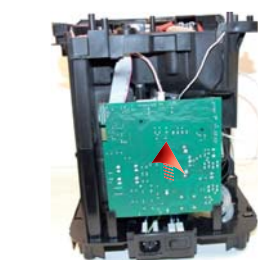

Slide the card off the support.

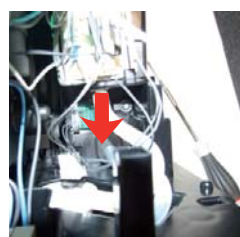

Slide out the pipe connecting the flow meter to the pump.



Loosen the screw as illustrated and remove the capacitive sensor glued to the seat.

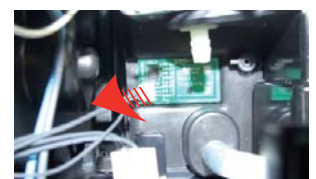

7.14. Gear motor

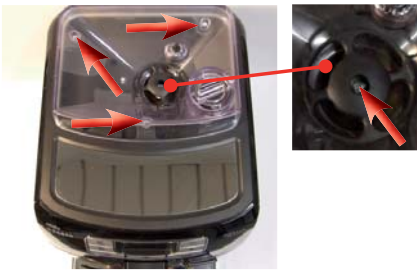

Unscrew the screws shown and remove the finger protection.



Lift the top cover.

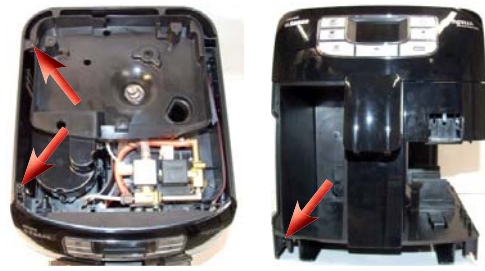

Unscrew the screws shown and slide out the left side body.



Unscrew the screws as illustrated and remove the front panel to access the screws which fix the dispenser cover into place.

Slide out the fork as illustrated.

Only for Intelia Cappuccino remove the plug body along with pitcher

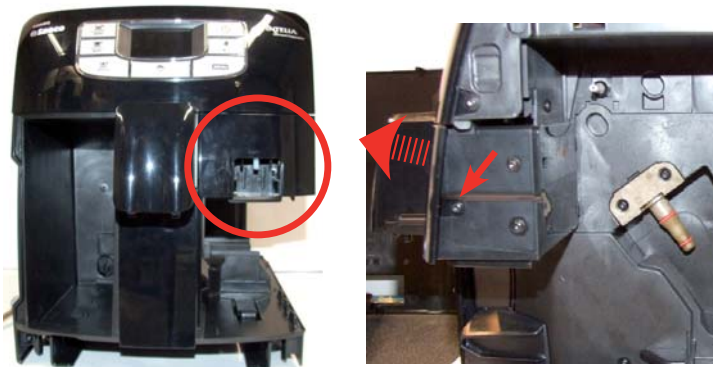

Unscrew the screws in the front cover and lift it off the milk jug plug body from the place

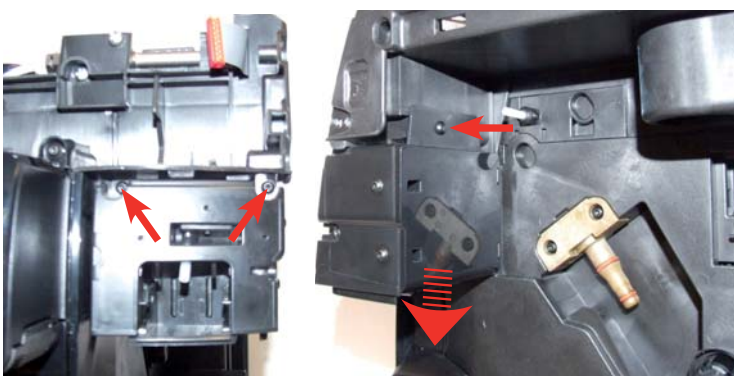

Unscrew the screws (highlighted) and release the milk jug plug body assembly

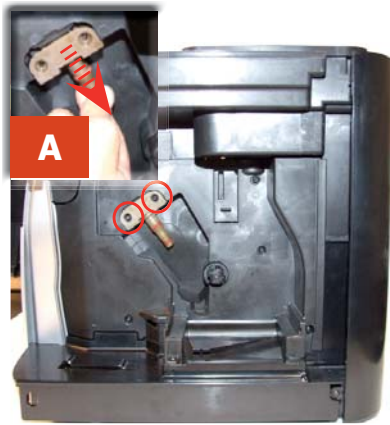

Loosen the screws as illustrated and remove the boiler pin (A).

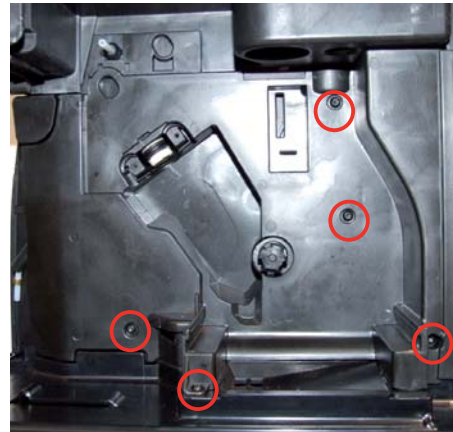

Loosen the screws as illustrated and remove the gear motor cover.

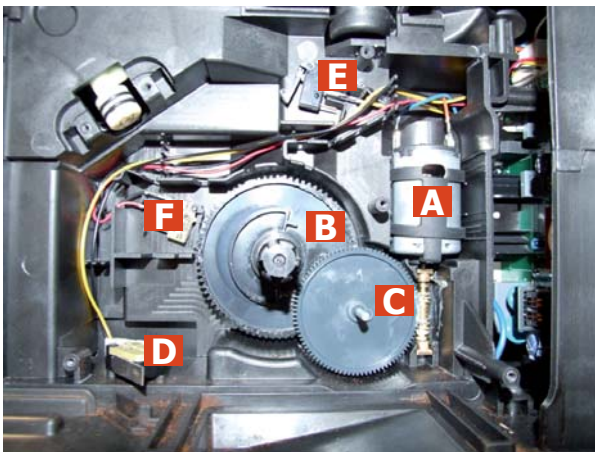

The following are located inside the compartment protected by the casing:

- Electric motor (A) with gears (B) and (C) for transmission and timing of the dispenser.
- Dreg drawer presence sensor (D).
- Brewing unit present microswitch (E).
- Microswitch (F) detecting brewing unit home and work positions.
- Remove the gear (C) that meshes with the motor transmission shaft.
- Remove the large gear (B).
- Remove the motor (A), complete with transmission shaft.

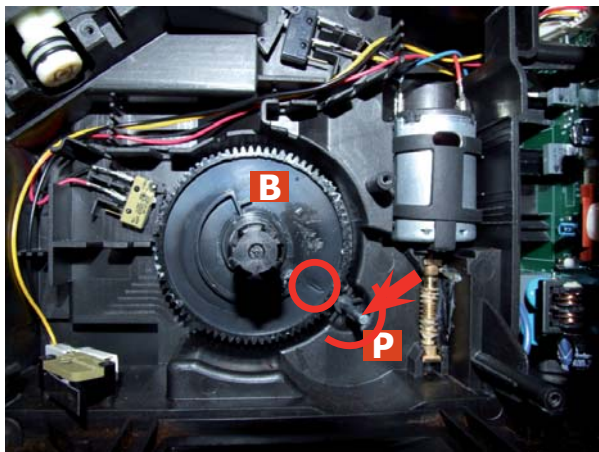

Replace the gear (B), making sure that the imprint of the arrow is aligned with the opening containing the pin (P).



When replacing the motor and the transmission shaft, make sure the guide runners (L) are in the right position.

Grease the shaft thoroughly and evenly.

7.15. Boiler

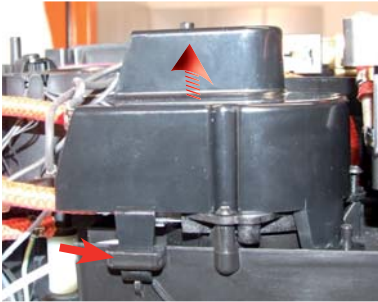

Release the boiler cover and take it off.



Unscrew the marked screw and disconnect the electrical and water circuit connections.

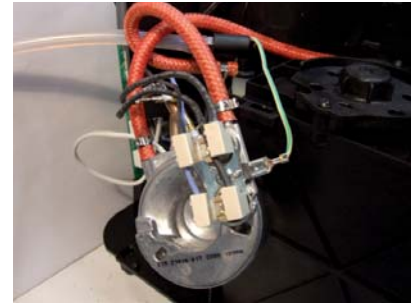

7.16. Dispenser assembly

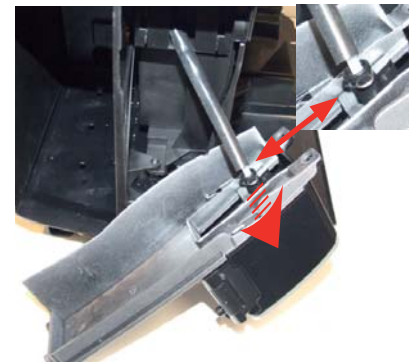

Loosen the screws as illustrated and remove the front panel to access the screws which fix the dispenser cover into place.

Slide out the fork as illustrated.



Press the hooks as illustrated and slide out the dispenser assembly.

7.17. Valve disassembly

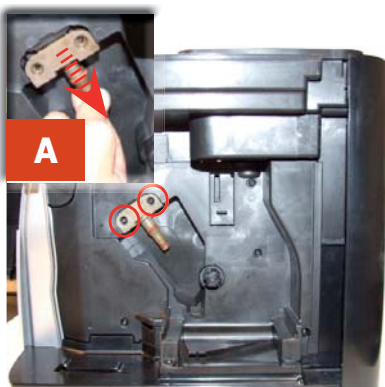

Loosen the screws as illustrated and remove the boiler pin (A)



Loosen the screws as illustrated and remove the front panel to access the screws which fix the dispenser cover into place



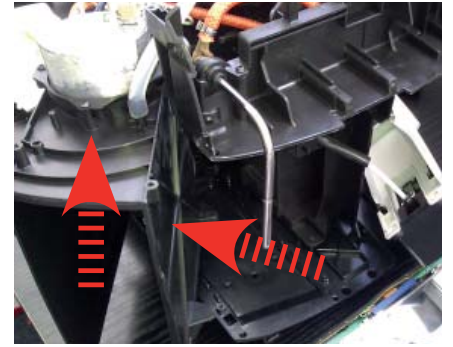
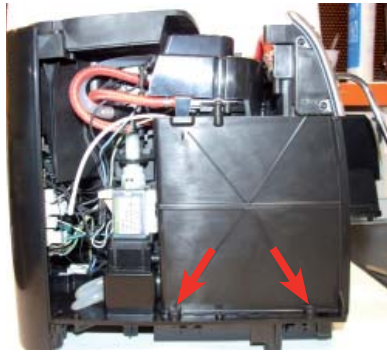

Loosen the screws as illustrated and release the insert in the bottom of the body to obtain easy access for valve disassembly

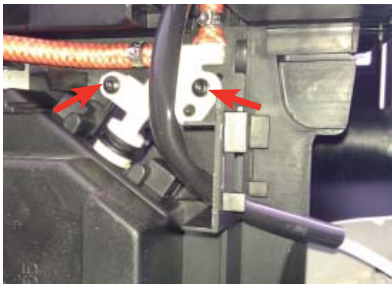

Loosen the screws as illustrated, remove the hydraulic connections and take out the valve

7.18. Control board and display



Loosen the screws as illustrated and remove the front panel.



Disconnect the electrical connections and unhook the card support.



Loosen the screws as illustrated.



Remove the frame from the keypad and the display.



Loosen the screws as illustrated.

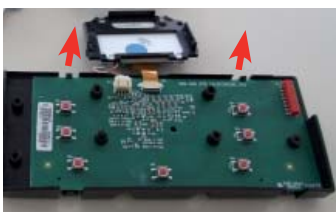

Remove the electrical connections between the card and the display and release the card from the support.

7.19. Fitting and removing Oetiker clamps

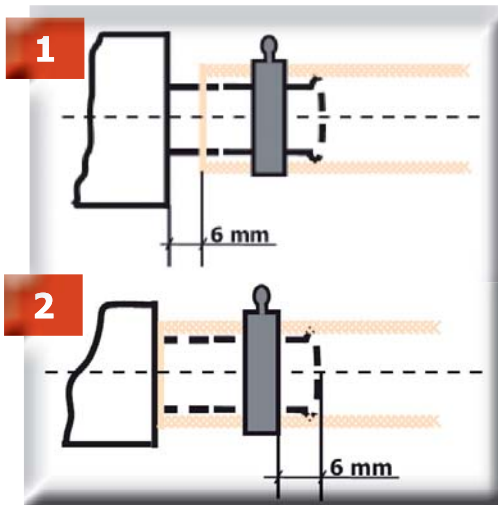

1) Boiler connection.

2) Other connections.

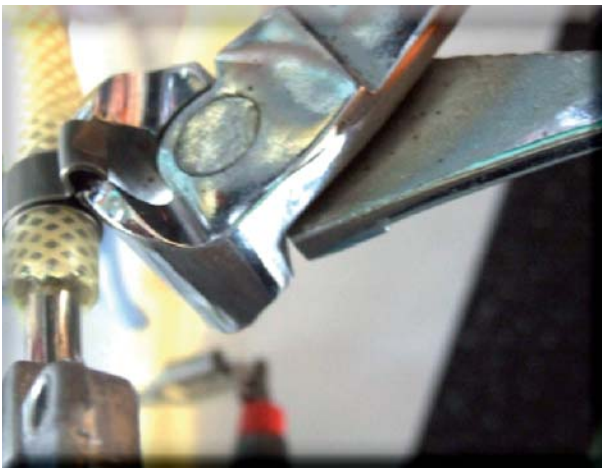

Use a suitable pair of pliers to remove the clamp (as illustrated).



Tighten the clamp as illustrated.



CHAPTER 8

NOTES



CHAPTER 9

WATER CIRCUIT DIAGRAM

Intelia Cappuccino

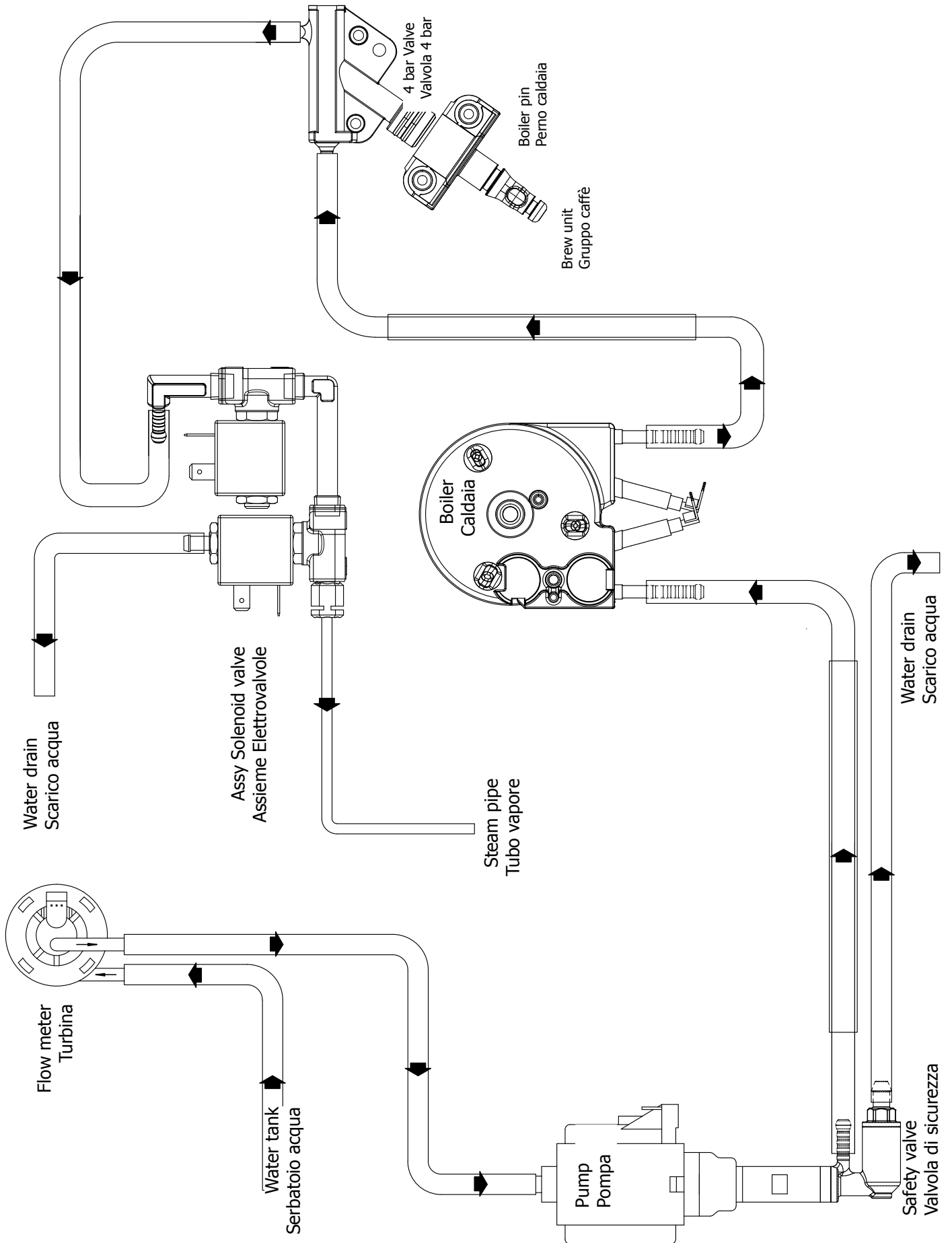

Intelcia Focus - Class - Latte and Intuita

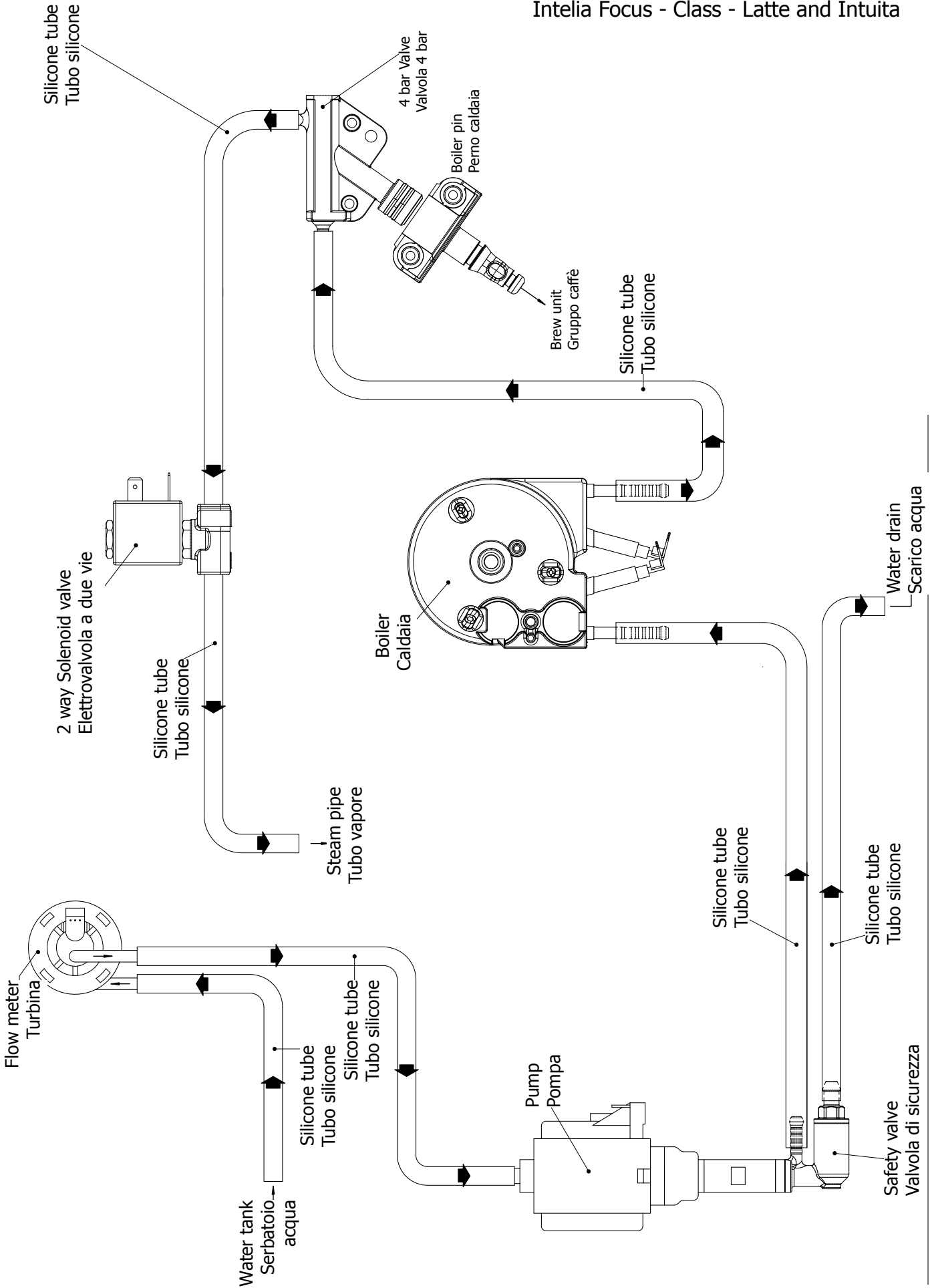



CHAPTER 10

ELECTRICAL DIAGRAM

Intelcia Focus - Class - Latte and intuita

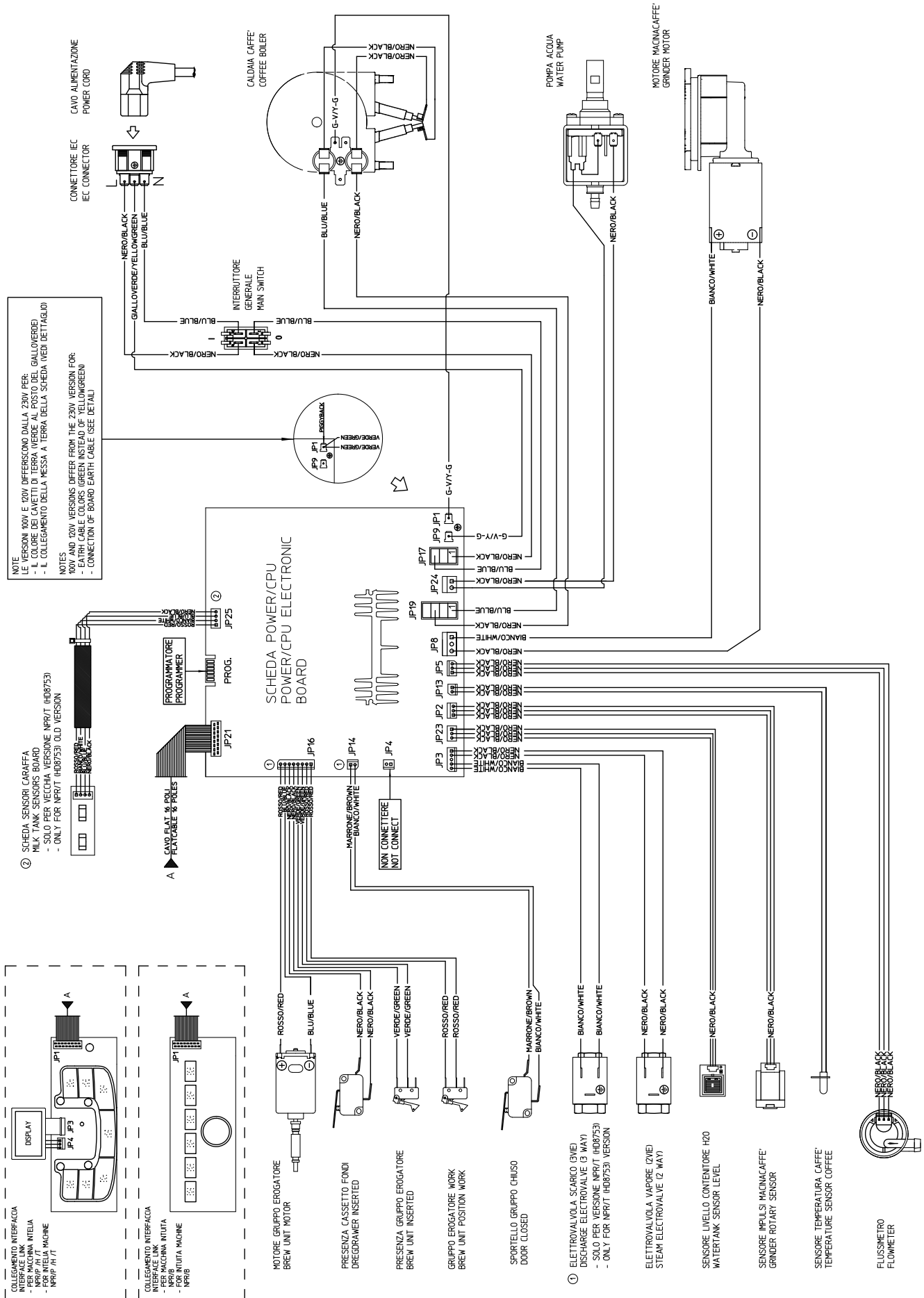

Intelial Focus - Class - Latte and intuita V2

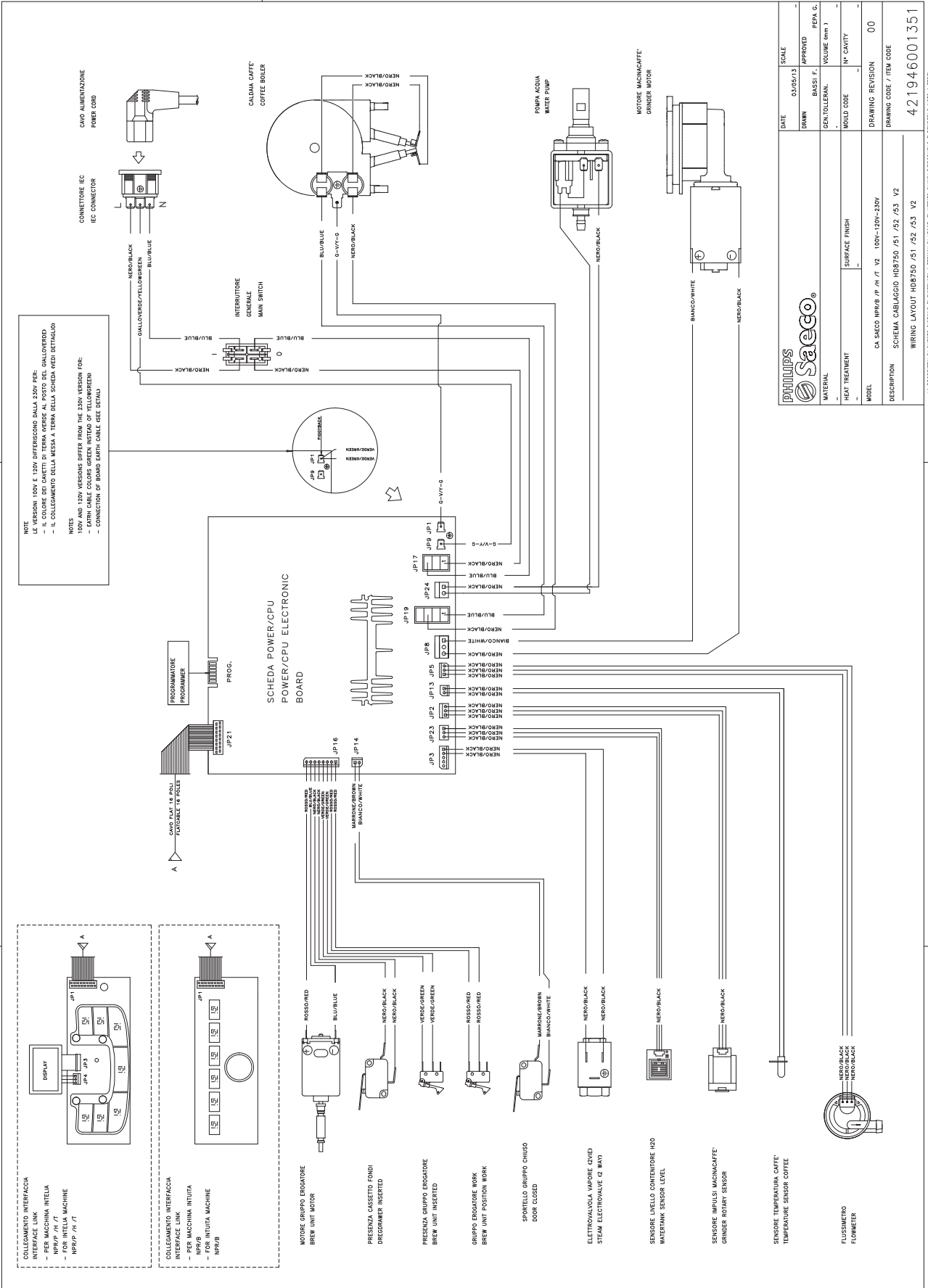

DATE	05/25/13	SCALE	00
APPROVED	DA S. F.	APPROVED	REDA G.
DESIGNER	DA S. F.	DESIGNER	REDA G.
MATERIAL	DA S. F.	MATERIAL	REDA G.
HEAT TREATMENT	DA S. F.	HEAT TREATMENT	REDA G.
MODEL	DA S. F.	MODEL	REDA G.
DESCRIPTION	DA S. F.	DESCRIPTION	REDA G.
DRAWING CODE / ITEM CODE	421946001351	DRAWING CODE / ITEM CODE	421946001351

A2
UNI 934-96

VALIDO PER PRODUZIONE
MATERIAL REV. 00

WIRING DIAGRAM

WIRING DIAGRAM