

Service Service Service

Intelia - Intuita



Service Manual

Rev. 06 November 2015

| Table of contents | Page | Table of contents | Page |
|--|------|--|------|
| 1. Introduction | 4.6 | Low bean level detection, dose quantity adjustment, coffee grinder blocked | |
| 1.1. Documentation required | 1 | 4.7. Dose self-learning (SAS) | 6 |
| 1.2. Tools and equipment required | 1 | 4.8. Water level detection (water tank) | 7 |
| 1.3. Material | 1 | 4.9. Descaling request | 7 |
| 1.4. Safety warnings | 1 | 4.10. Water filter | 8 |
| 1.5. Service Policy | 2 | 4.11. Intelia Cappuccino milk carafe | 8 |
| 1.6.1. External machine parts | 3 | | |
| 1.6.2. Internal machine parts | 4 | 5. Troubleshooting | |
| | | 5.1.1. Intelia Cappuccino test mode | 1 |
| 2. Technical specifications | | 5.1.2. Intelia Focus and Class Test mode | 6 |
| 2.1. Technical specifications | 1 | 5.1.3. Intelia Latte test mode | 11 |
| 2.2. Specification for the measurement of the coffee products temperature | 2 | 5.1.4. Intuita test mode | 16 |
| 2.3.1. Specification for the measurement of the Milk products temperature. | 3 | 5.2. Error messages | 22 |
| 2.3. Machine parameters and performance | 5 | 6. Servicing and maintenance | |
| | | 6.1. Repair flow | 1 |
| 3. User instructions | | 7. Disassembly | |
| 3.1. Intelia Cappuccino customer and programming menu | 1 | 7.1. Intelia Cappuccino outer Shell | 1 |
| 3.2. Intelia Latte customer and programming menu | 3 | 7.2. Intellia Class and Focus outer Shell | 2 |
| 3.3. Intelia Focus and Class customer and programming menu | 6 | 7.3. Coffee grinder | 2 |
| 3.4. Intuita customer and programming menu | 8 | 7.4. Grinder blades | 3 |
| 3.5. Operation, cleaning and maintenance | 10 | 7.5. Coffee grinder adjustment | 4 |
| 4. Operating logic | | 7.6. Intelia Cappuccino three-way solenoid valve | 4 |
| 4.1. Water circuit | 1 | 7.7. Intelia Class and Focus two-way solenoid valve | 5 |
| 4.2. Coffee cycle | 3 | 7.8. Two-way solenoid valve (V2) | 5 |
| 4.3. Single microswitch | 4 | 7.9. Intelia Cappuccino carafe fitting body | 5 |
| 4.4. Temperature sensor | 4 | | |
| 4.5. Coffee grinder | 5 | | |

All parts of this document are the property of Saeco International Group.

All rights reserved. This document and all the information herein is provided without liability deriving from any errors or omissions. Furthermore, no part may be reproduced, used or collected, except where express authorisation has been provided in writing or through a contractual agreement.

| Table of contents | | Page |
|-------------------|-------------------------------------|------|
| 7.10 | Pump | 6 |
| 7.11. | Flow-meter | 6 |
| 7.12. | Power board | 6 |
| 7.13. | Water sensor control board | 6 |
| 7.14. | Gear motor | 7 |
| 7.15. | Boiler | 9 |
| 7.16. | Dispenser assembly | 9 |
| 7.17. | Valve disassembly | 9 |
| 7.18. | Control board and display | 10 |
| 7.19. | Fitting and removing Oetiker clamps | 11 |

8. Notes

9. Water circuit diagram

10 Electrical diagram

| MODIFICATIONS TO SERVICE MANUAL | | | | |
|--|----------------|----------------|---|---|
| From Rev. | To Rev. | Chapter | Inserted | Modified |
| REV.05 | REV.06 | 01 | | 1.4 Safety warnings |
| | | 02 | | 2.2 Specification for the measurement of the coffee products temperature. |
| | | 02 | 2.2.1 Specification for the measurement of the Milk products temperature. | |
| | | 06 | | 6.1 Repair flow |



CHAPTER 1

INTRODUCTION

1.1 Documentation required

The following documentation is needed for repair procedures:

- Instruction booklet for specific model
- Technical documentation for specific model (diagrams, exploded view, symptom cure and service manual)

1.2 Tools and equipment required

As well as the standard equipment, the following is required:

| Qty. | Description | Notes |
|------|----------------------------|--|
| 1 | Screwdriver | Torx T 8 - T 10 - T 20 |
| 1 | Pliers for Oetiker clamps | |
| 1 | CC -A - Vdc tester | |
| 1 | Digital thermometer | Scale limit > 150°C |
| 1 | SSC (Saeco Service Center) | Programmer (for programming and diagnostics mode) |

1.3 Material

| Description | Notes |
|-----------------|-------------------------|
| Thermal paste | Heating element > 200°C |
| Descaler | Saeco descaler |
| Grease solvent | Personal choice |
| Silicone grease | Safe to use with food |

1.4 Safety warnings

We recommend you consult the technical manual of the machine before performing any maintenance work.

Observe all applicable standards relating to the repair of electrical appliances.

Always disconnect the power plug from the mains before beginning repair work.



Simply turning off the main machine power switch is not an adequate safety precaution. This domestic appliance is rated as insulation class I.

On completion of the repair work, insulation and dielectric rigidity tests must be performed.



Disassembling the machine, the operator must pay attention to hot and under pressure parts: boiler, pin-boiler, valves, dispensing, steam tube, brew unit, connections and pipes to avoid burns. Please refer to specific hydraulic circuit (Image1) to know the parts in detail.



The machine hydraulic circuit can reach maximum pressure of 16/18 bar.

To operate in safety condition is recommended to perform the Steam Out procedure in order to remove the pressure and hot water inside the hydraulic circuit.

When the machine arrives at the Service Center in descaling mode interrupted, or making Descaling, be very careful not to come into contact with the Descaler.

After the product has been repaired, it should function properly and has to meet the safety requirements and legal regulations as officially laid down at this moment

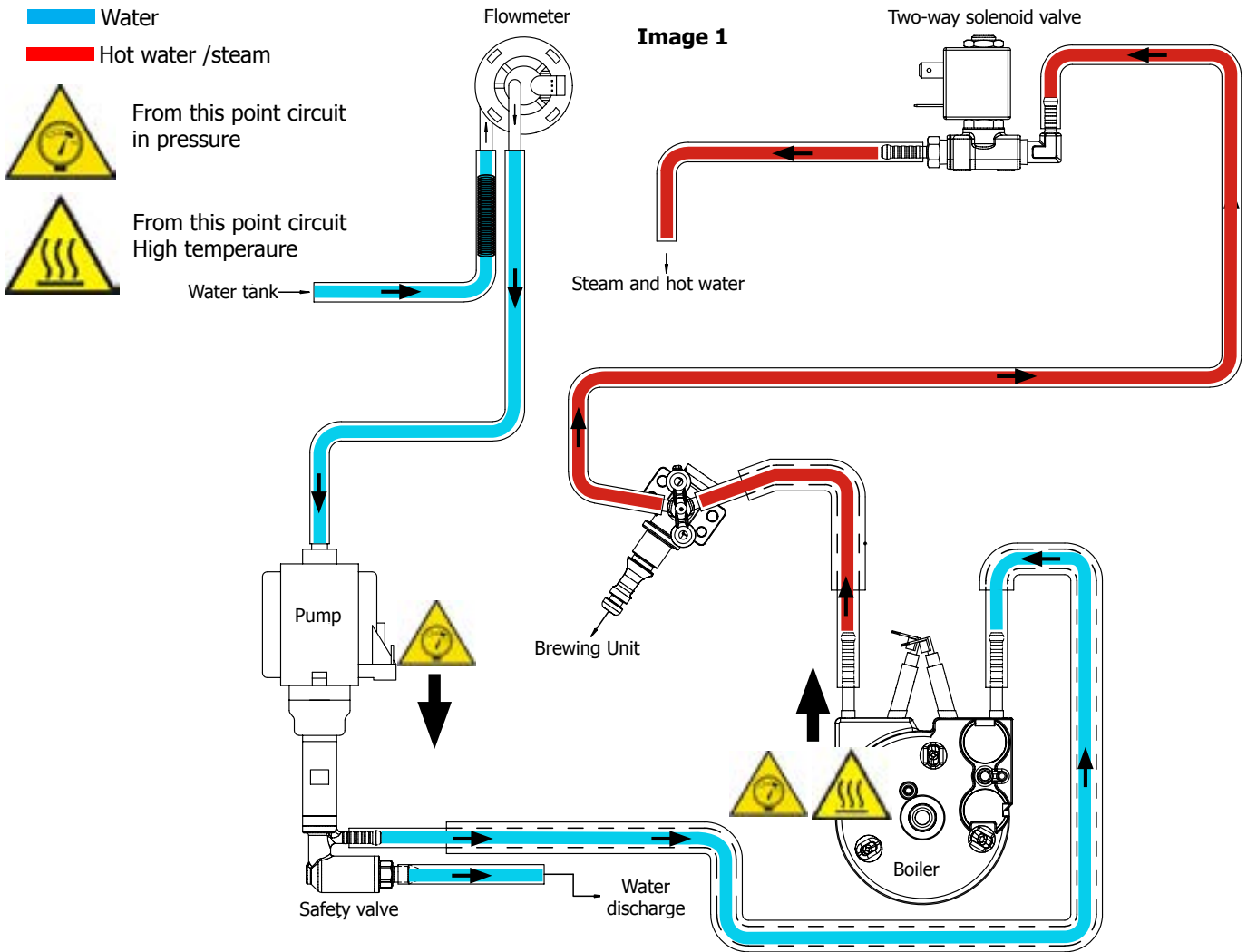

1.5 Service POLICY grid as used for coffee machine

FOR IN WARRANTY repairs is recommended to use when and where possible the single components, available in the exploded views of the coffee machines or of the specific components. If you find the information "SEE THE EXPLODED VIEW E....." in the assembly description field, it means that the single components of the assembly are available in the other pages of the exploded view. It's possible to use the assembly only if there is a specific Symptom Cure that include this possibility or when the single components are not available for the order.

List of principal assembly present in all our coffee machines

| Components | Assembly use | Single components available |
|-----------------------|-----------------------------|---|
| COFFEE GRINDER | <u>Only for OOW repairs</u> | YES , to consult the specific exploded-view of the machine or of the Coffee Grinder on website |
| BREWING UNIT | <u>Only for OOW repairs</u> | YES , to consult the specific exploded-view of the machine or of the Brewing unit on website |
| BOILER | <u>Only for OOW repairs</u> | YES , to consult the specific exploded-view of the machine on website |
| GEAR MOTOR | <u>Only for OOW repairs</u> | YES , to consult the specific exploded-view of the machine on website |
| FILTER HOLDER | <u>Only for OOW repairs</u> | YES , to consult the specific exploded-view of the machine on website |
| MILK CARAFE | <u>Only for OOW repairs</u> | YES , to consult the specific exploded-view of the machine on website |
| THERMAL CARAFE | <u>Only for OOW repairs</u> | YES , to consult the specific exploded-view of the Thermal Carafe on website |
| MILK ISLAND | <u>Only for OOW repairs</u> | YES , to consult the specific exploded-view of the Milk Island on website |

1.6.1 External machine parts

Intelia Cappuccino

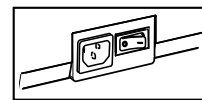
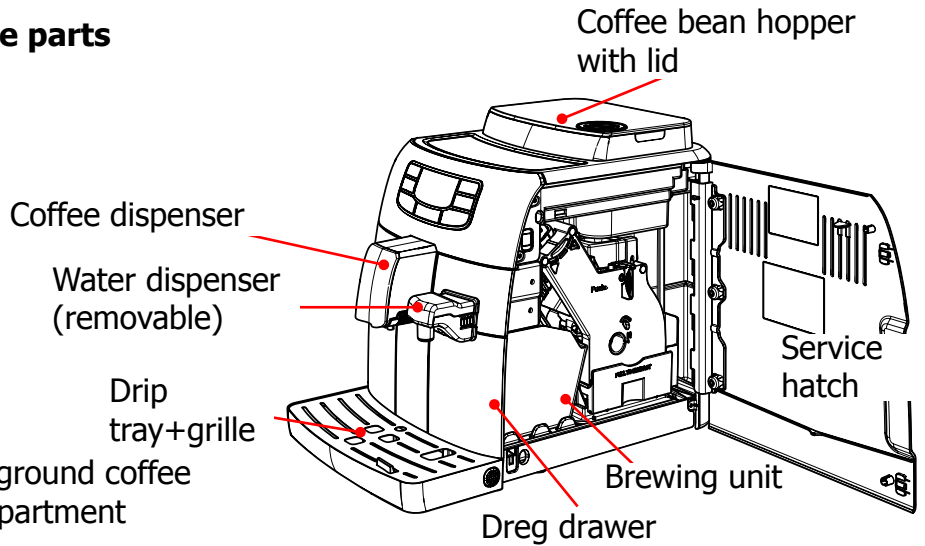
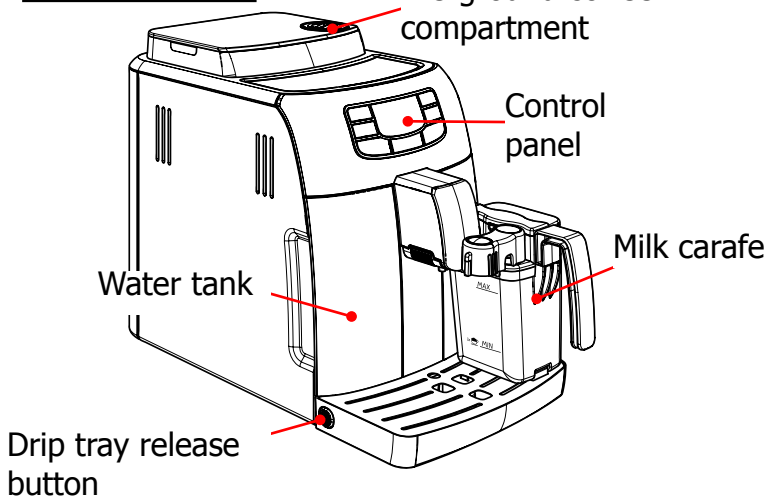
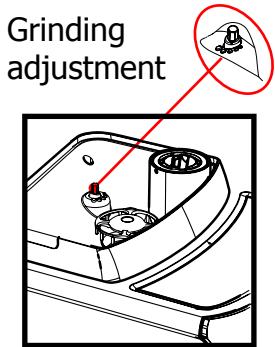

Power cable socket and main switch

- Espresso dispensing button
- Long espresso dispensing button
- Hot water/steam selection button

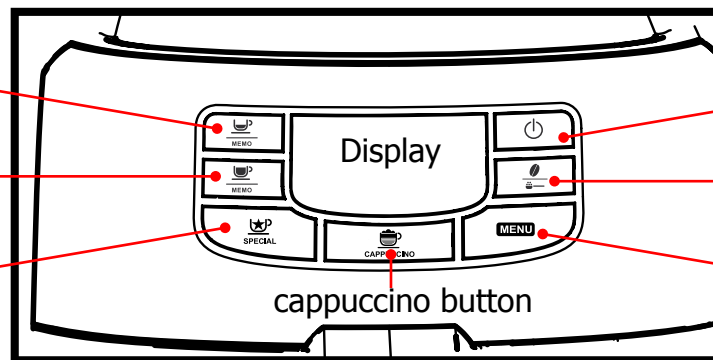

- ON/OFF button
- Aroma / Pre-ground button
- MENU button

Intelia Latte

- Espresso coffee brew button
- Long espresso brew button
- "Aroma" - Pre-ground coffee button
- "MENU" button

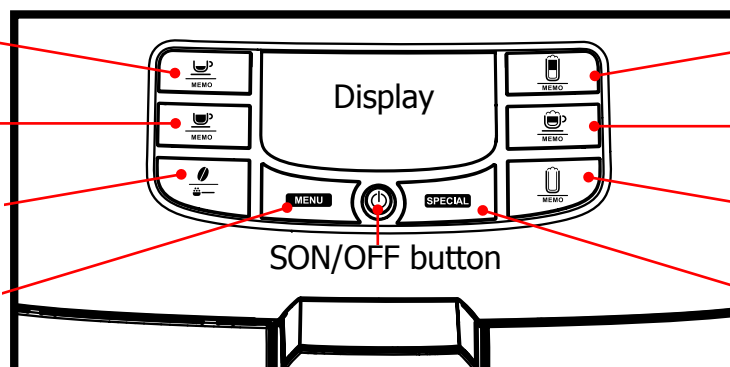

- Latte Macchiato brew button
- Cappuccino brew button
- Hot Milk brew button
- Special beverages selection button

Intelia Class e Focus

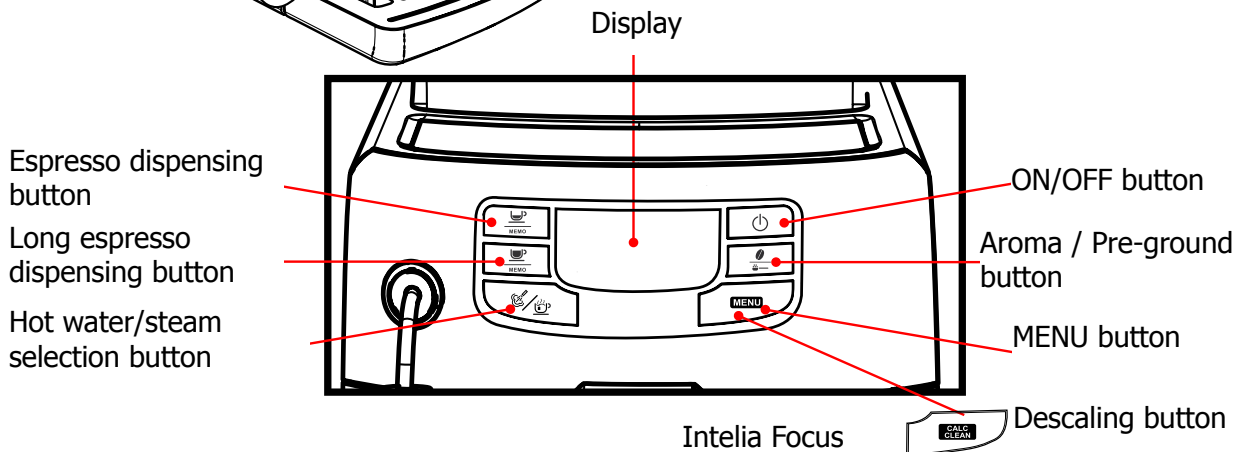
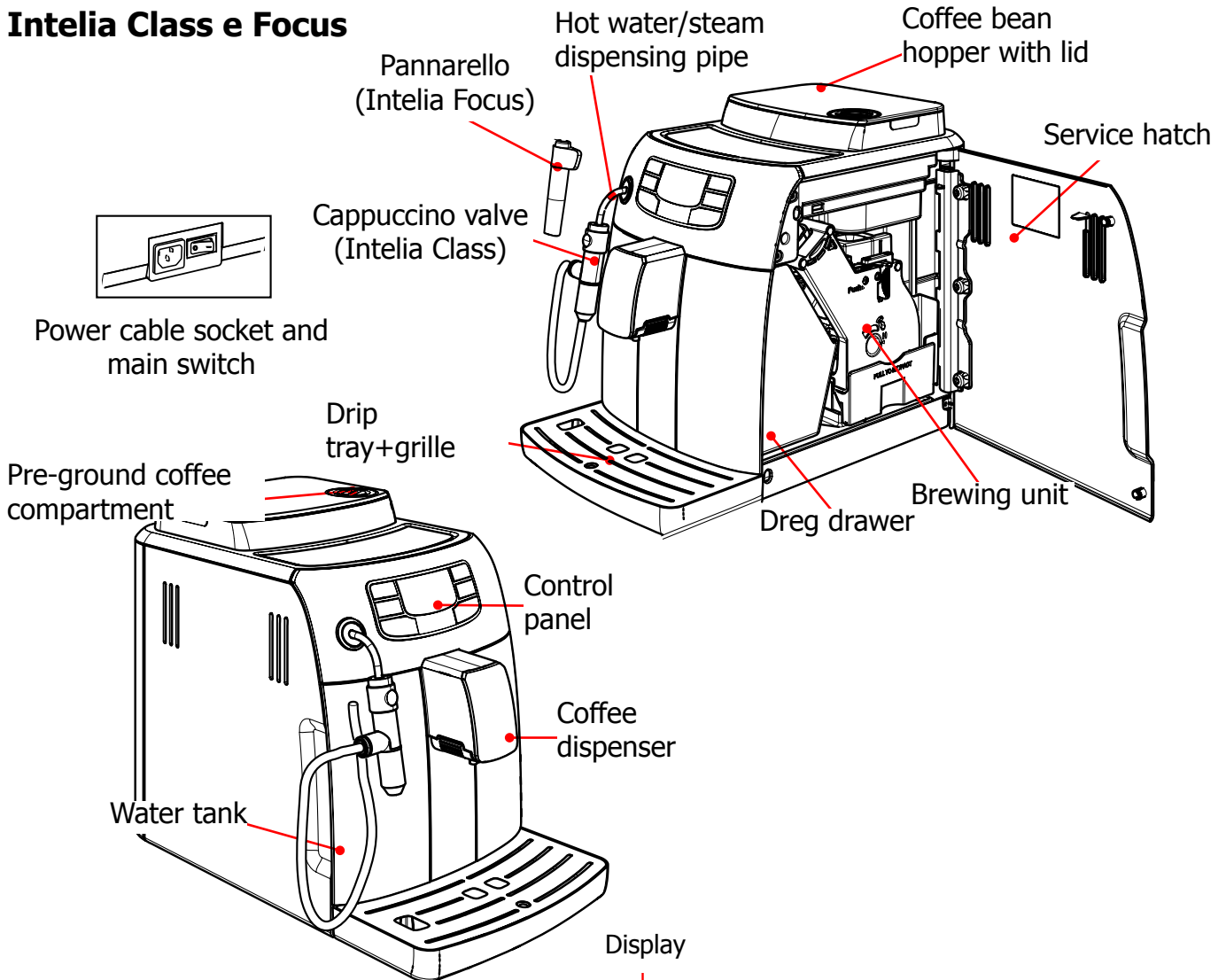

Intuita

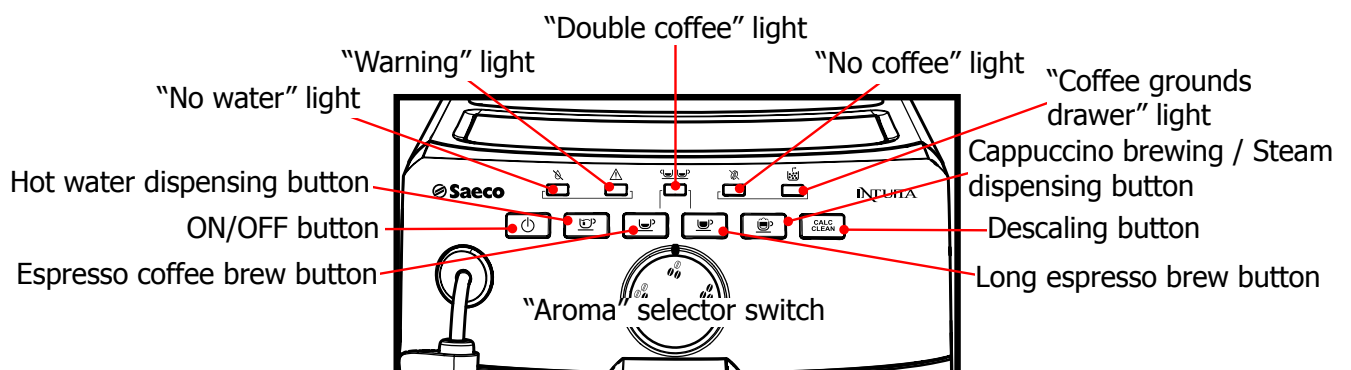

1.6.2 Internal machine parts

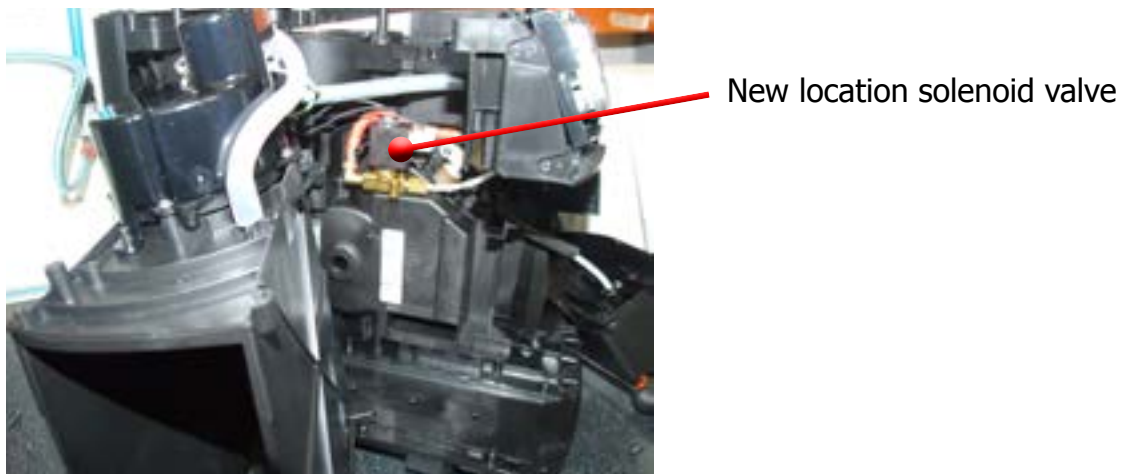
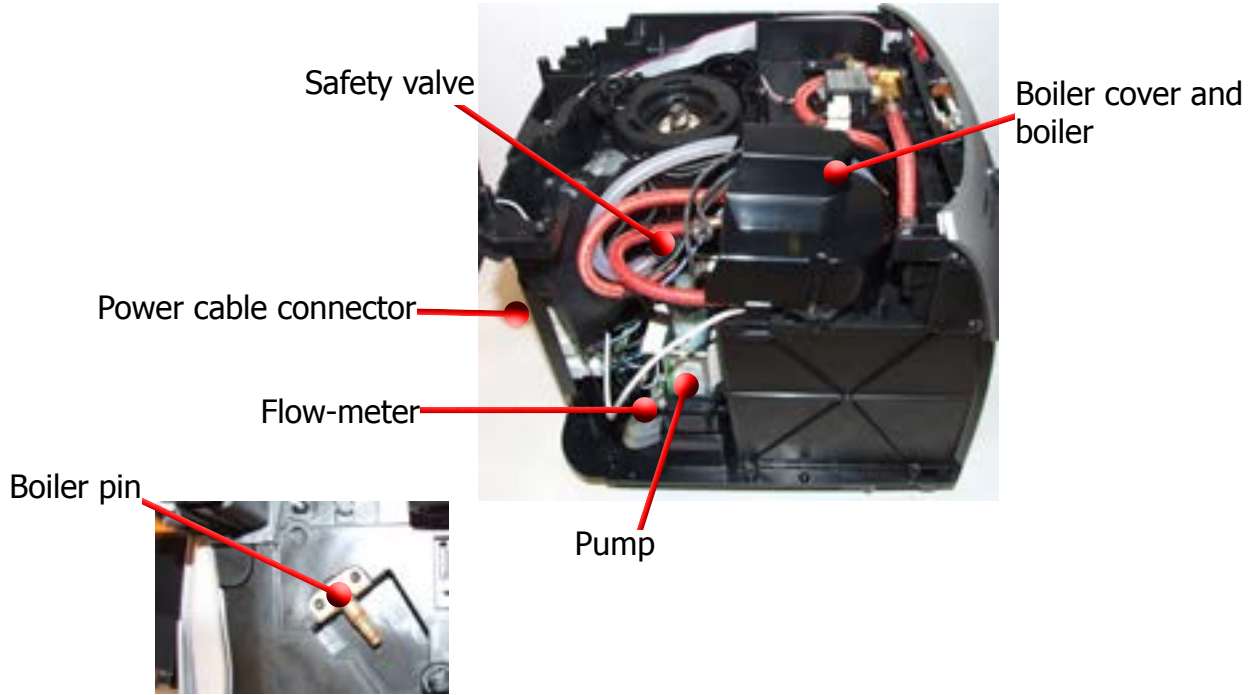
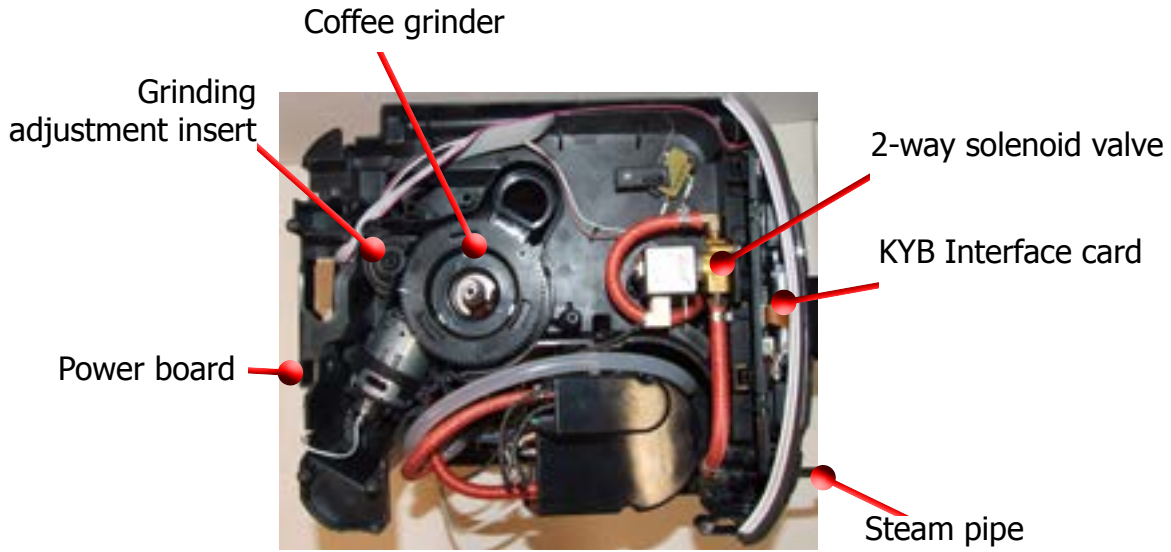



CHAPTER 2

TECHNICAL SPECIFICATIONS

2.1. Technical specifications

| | |
|--|--|
| Power supply and output: | 240 V~ 50 Hz 1850 W - 230 V~ 50/60 Hz 1850 W 120 V~ 60 Hz 1500 W - 100 V~ 50/60 Hz 1300 W |
| Temperature monitoring: | (NTC) variable resistor sensor - transmits the value to the electronic card |
| Safety system: | 2 thermostats at 190°C one shot |
| Coffee heat exchanger output: Stainless steel | (230 V~) 1900 W for coffee, hot water and steam dispensing |
| Steam heat exchanger output: Stainless steel | As above |
| Gear motor: | 2 rotation directions; power supply 24VC |
| Pump: | Ulka Type EP5/S GW approx. 13-15 bar with reciprocating piston and thermal switch 100°C 48 W, 230V, 50 Hz, 120V, 60Hz 100V, 50/60 Hz |
| Overpressure valve: | Opening at approx. 16-18 bar |
| Water filter: | In tank |
| Coffee grinder: | Direct current motor with flat ceramic grinder blades |
| Automatic dosage: | Dose adjustment controlled by the electronic system |
| Power consumption: | During heating phase- approx. 5.6 A |
| Dimensions: W x H x D in mm: | 256x340x440 (data may vary depending on the model) |
| Weight: | 9 kg |
| Water tank capacity: | 1.5 l |
| Coffee bean hopper capacity: | 300 g. of coffee beans |
| Dreg drawer capacity: | 10 |
| Heat exchanger capacity: | 10 (11 if after 9 dregs you dispense a double espresso) |
| Water circuit filling time: | Approx. 15 sec Max. on first filling cycle |
| Heating time: | Approx. 45 sec. |
| Grinding time: | Approx. 8-10 sec. |

2.2. Specification for the measurement of the coffee products temperature.

The temperature is influenced by the flow from the dispenser and stratification of temperatures in the glass. In order to consider these phenomena and to introduce measures that allow comparisons in controlled conditions, below guidelines must be followed:

Conditions:

- Water temperature in tank: 23°C (+/-2°C).
- It must be used a plastic cup (see picture N°1).
- It must be used a thermocouple thermometer (e.g. type K - see picture N°2).
- The coffee machine is tested without any change of parameters or calibrations, which may affect the temperature of products, so the measurement of temperature must be done with machine in default factory setting.

Procedure:

- The temperature must be measured in the cup, immediately after dispensing. Cup has to be placed on a non-metal surface using a thermocouple thermometer (Picture 1).
- The temperature in the cup is measured by immersing the probe of the thermometer up to touch the bottom. The probe then must be moved in a circular motion for 5/6 rotations. At the of the rotations, stop in the center of the cup (Picture 2).
- The highest temperature measured during the rotations is the value we are searching for, and that must be reported;
- Test measurement: from end of dispensing to the end of rotations must be completed within 12 seconds.
- the distance of the probe from the bottom of the glass is a function of the quantity of coffee dispensed: 10mm for 35gr - 17mm for 60gr - 35mm for 120gr and superior (Picture 3).

Limits of acceptability

The acceptance limits are divided by features and products and are the following:

Espresso Coffee Italy Q.ty 25/40 gr.

Temperature of 1st product 69°C ≤ 85°C
Temperature of 2nd product 72°C ≤ 85°C

Coffee Q.ty 70/120 gr.

Temperature of 1st product 69°C ≤ 85°C
Temperature of 2nd product 72°C ≤ 85°C

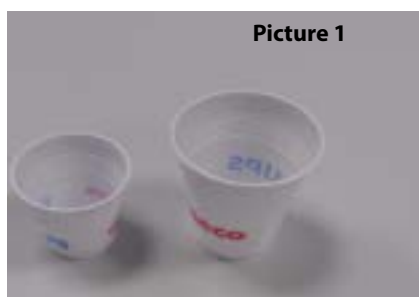

Picture 1



Picture 2

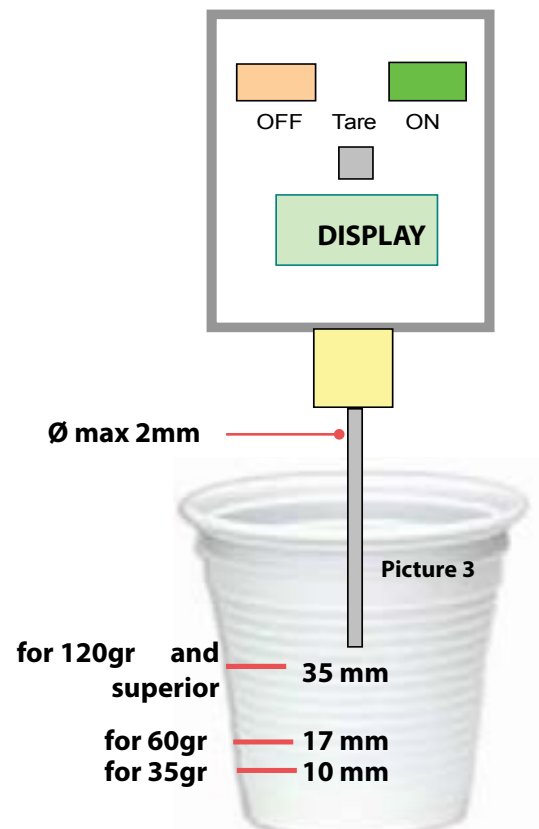

2.2.1. Specification for the measurement of the Milk products temperature.

Milk evaluation

To carry out the test, a partially skimmed UHT milk with a percentage of grease between 1.5-1.8% at a refrigerator temperature T_{refr} . (between 4 to 10°C) must be used.

The milk product must be checked on a beaker of 250 ml of capability and with an inner diameter of 70mm, brewing 100gr of product.

Parameters to be respected:

The parameters to be respected are: milk temperature and height of the cream. Each of these parameters, however, must be evaluated depending on the type of system used for the production of hot milk. Actually three types of devices are present on the appliances:

- Manual system (pannarello)
- Semi-Automatic system (cappuccinatore)
- Automatic system (carafe, Pinless wonder system, etc.)

Milk temperature in the beaker:

System with Pinless Wonder: With milk at T_{refr} . (about 4-10 °C): $\rightarrow \Delta \geq 45$

how does it work:

1. The milk is heated in the first chamber of the carafe thanks to the steam.
2. Then, it is mixed with air and frothed in the middle chamber.
3. Finally, in the outlet chamber, the 'typhoon effect' perfects the milk texture by removing the large bubbles

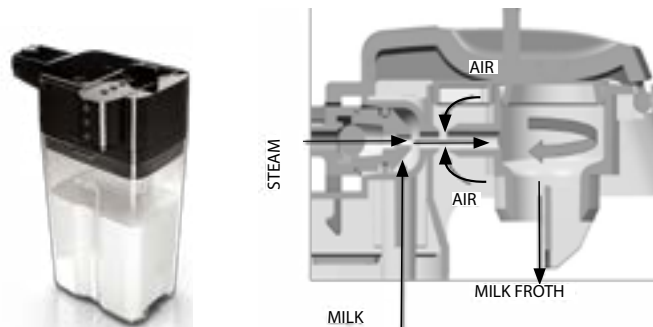

Height of the milk cream in the beaker:

Manual system (pannarello) $\geq 15\text{mm}$ on 100gr. of brewed product

Semi-automatic system (cappuccinatore) $\geq 20\text{mm}$ on 100gr. of brewed product

Automatic system: carafe, cappuccinatore, Pinless wonder e.g. (New Royal, Energica Pure, Intelia EVO latte) $\geq 20\text{mm}$ on 100gr. of brewed product

How to measure the temperature of the milk.

1. The measurement is carried out in the beaker, immediately after the end of milk brew, positioned on a non-metallic surface, using a thermocouple thermometer (eg. Type K). Stop the preparation of mixed product: at the end of milk brewing, where "One Touch product" function is present.
2. The temperature is measured by immersing the probe of the thermometer, positioning the probe inside the beaker at about 10mm from the bottom of the container, then the probe moves in a circular motion for 3-5 turns, stopping at the end, at the center of the beaker. It detects the maximum temperature reached in a time of relief between 3 to 5 seconds. It is important the mixing of milk before the measurement at 10mm from the bottom of the beaker. If the mixing is correct, temperature, for a few fractions of a second, during the measurement should not oscillate.

How to measure the milk cream.

The temperature (T_{refr} or T_{amb}) of the milk doesn't affect as much the test result on measuring the milk cream; by convection is assumed to always use milk at refrigerator temperature T_{refr} .

Manual systems (Pannarello)

Pour 100cc. of milk at T_{refr} . in a beaker of 250 ml of capacity and with a inner diameter of 70 mm; with machine in steam mode:

1. Open the steam knob to discharger water circuit for 4 sec, then close the knob.
2. Place the beaker with the frother dipped in milk, open the steam knob to maximum and start the chronometer.
3. After about 30 to 60 seconds, close the knob and check the result on milk.

Semi-automatic systems (cappuccino)

Pours milk at T_{refr} . in a container ; with the machine in steam mode:

1. Open the steam knob to discharge water circuit for 4 sec. then close the knob.
2. Insert the silicone tube in the milk container, placing a beaker of 250 ml capacity and with an inner diameter of 70 mm under the cappuccino maker and open the steam knob.
3. After having provided 100gr. of product, close the knob and check the result obtained on milk.
Note: The same applies to machines which have a steam key on the user interface and a solenoid valve in place of the steam tap.

Automatic: Carafe, Cappuccino Pinless wonder e.g.:(New Royal, Energica Pure, Intelia EVO Latte), etc..

After setting the machine to delivery of 100gr. of product:

1. Launch the "hot milk" function.
2. Collect the product in a beaker with a 250ml of capacity and with an inner diameter of 70 mm, and verify the result obtained on milk. Carry out the test using milk at a T_{refr} .

In case the machine allows modify of the emulsion through the menu, use the machine with the emulsion set to the default value.

Related to the above testing procedure derives the following table of acceptability:

| Manual, Semi-Automatic and Automatic's Milk System | |
|---|----------------------------------|
| Grams of Product | Minimun Height of the milk cream |
| ≥ 130 | ≥ 30mm |
| 120 | ≥ 25mm |
| 110 | ≥ 22mm |
| 100 | ≥ 20mm |
| 90 | ≥ 16mm |
| 80 | ≥ 13mm |
| 70 | ≥ 11mm |

NB: To verify more accurately the height of the cream, a practical expedient dictated by experience is to add to the product just delivered a small amount of coffee. The addition of coffee immediately put in evidence the surface of separation between liquid and cream.

2.3. Machine parameters and performance

| PRODUCT QUANTITY | Minimum quantity (Puls.) | Default quantity (Puls.) | Maximum quantity (Puls.) | User programmable | Programm. by Production / Service |
|-----------------------------------|---|--------------------------|--------------------------|-------------------|-----------------------------------|
| Espresso | 50 | 165 | 600 | Yes | No |
| Long coffee | 70 | 440 | 600 | Yes | No |
| Pre-ground | No | | | | |
| Hot water | Continues until the water supply has been exhausted (capacitive sensor) | | | | |
| Steam pannarello (frother) | Continues until the water supply has been exhausted (capacitive sensor) | | | | |

| RINSE | Initial rinse | Final rinse |
|---|---|---|
| When performed | When the machine is switched on and the boiler temperature is $\leq 50^{\circ}\text{C}$ | When the machine is switched off electronically, manually or automatically after 30', if at least one coffee has been dispensed, before switching off |
| No. of pulses | 180 | 80 |
| Stopping option | Yes, by pressing any key | Yes, by pressing any key |
| User disable option | No | No |
| Production/Service department disable option | No | No |
| No. of pulses user adjustment option | No | No |
| No. of pulses Production/Service department adjustment option | No | No |
| Pulse range (Min. – Max.) | No | No |

| Descaling cycle frequency | | | |
|---------------------------|------------------------|-----------------------------|-----------------------------|
| Hardness | Water hardness | Without water filter | With water filter |
| 1 | Soft (up to 7°dH) | 240 litres (480,000 pulses) | 480 litres (960,000 pulses) |
| 2 | Medium (7° - 14°dH) | 120 litres (240,000 pulses) | 240 litres (480,000 pulses) |
| 3 | Hard (15° - 21°dH) | 60 litres (120,000 pulses) | 120 litres (240,000 pulses) |
| 4 | Very hard (over 21°dH) | 30 litres (60,000 pulses) | 60 litres (120,000 pulses) |

The default water hardness level is 4. Each litre of water corresponds to approximately 2,000 pulses.

In the machines where is not possible change the water hardness the default hardness level is 3.

| DREG DRAWER | Description and values |
|---------------------------------|---|
| Time-out for dreg drawer | 5 sec. |
| Reset dreg counter | Dreg emptying alarm, if the dreg drawer is removed for more than 5 seconds. |

| STANDBY | Description and values |
|--|-------------------------------|
| Inlet time (default) | 30 minutes |
| Inlet time programmed by Production/Service | Yes |
| Boiler temperature during Standby | Boiler OFF |

| WATER TANK | Description |
|---|--------------------|
| Water reserve (pulses) with water filter | 200 |
| Water reserve (pulses) with no water filter | 200 |
| Water reserve modifiable by Production/Service departments | No |
| "Fill tank" alarm | Yes |
| "No tray" alarm | Yes (Fill tank) |
| Water mains | No |



CHAPTER 3

USER INSTRUCTIONS

3.1. Intelia Cappuccino customer and programming menu

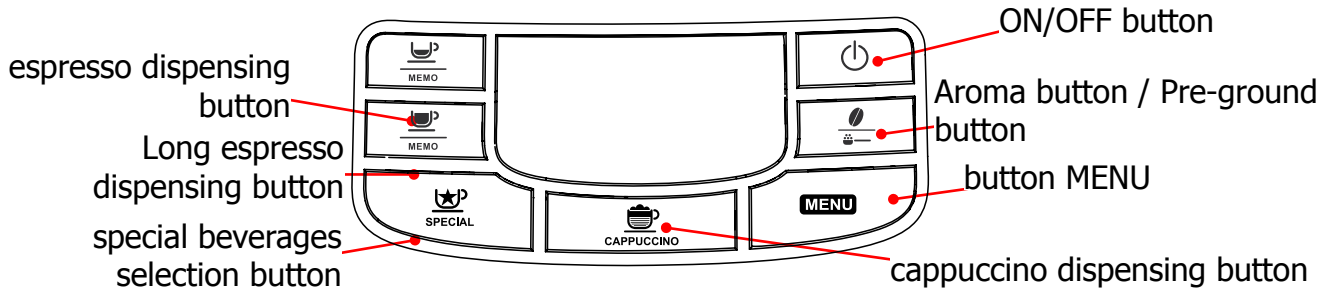

Machine ready signals (**GREEN**)

| | | | |
|--|--|--|---|
| | Machine at correct temperature - for coffee bean dispensing - for hot water dispensing | | Machine dispensing 1 espresso |
| | Machine at correct temperature - for ground bean dispensing (pre-ground) | | Machine dispensing 1 coffee |
| | Hot water or hot milk selection | | Machine dispensing 2 espresso |
| | Hot water dispensing | | Machine dispensing 2 coffees |
| | Dispensing hot milk | | The machine is being programmed with the coffee cup fill level |
| | Machine dispensing milk during the preparation of cappuccino | | The machine is being programmed with the amount of milk to be dispensed to prepare cappuccino |
| | Machine dispensing coffee during the preparation of cappuccino | | The machine is being programmed with the amount of coffee to be dispensed to prepare cappuccino |

Notice signals (**ORANGE**)

| | | | |
|--|---|--|--|
| | Machine in pre-heating phase for coffee, hot water and steam dispensing | | Brewing unit resetting during appliance reset |
| | The appliance is rinsing, wait until end of operation | | Fill the coffee bean container and start the dispensing cycle |
| | The machine signals that the "INTENZA+" filter must be replaced | | Proceed to load the circuit |

If this screen appears after you switch the machine on, it means that you must run a descaling cycle.
 Press "MEMO" to access the descaling menu and consult the relative paragraph.
 Press "ON/OFF" to continue using the machine.

Alarm signals (**RED**)

Close the service door.



Insert the dreg drawer.



No beans inside the coffee container.
After filling the container, the cycle can be restarted.



Empty the dreg drawer and the drip tray.



The Brewing Unit must be inserted in the machine.



Fill water tank.



Insert the drip tray as far as it will go.



Switch the machine off, wait for 30 seconds and switch it back on again. Repeat 2 or 3 times.
If the machine does NOT start, contact the service center.

MENU (commands and programming)

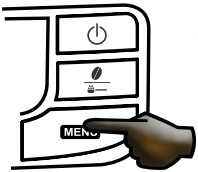

You can access the programming menu only when the machine is on.
Press the menu button to access programming.

**Coffee temperature:**

This function allows the coffee dispensing temperature to be adjusted.

**Timer (stand-by)**

This function lets you adjust the time for switching to Stand By after the last dispensing.

**Contrast**

This function lets you adjust the display contrast for better viewing of the messages.

**Water hardness**

This function lets you adjust the water hardness so that machine maintenance is managed better:

1 = very soft water 2= soft water 3 = hard water 4 = very hard water

**"INTENZA+" water filter**

This function lets you manage the "INTENZA+" water filter.
For details see the paragraph concerning the filter management.

**Descaling Cycle**

This function lets you execute a descaling cycle.

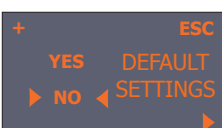
**Factory settings**

This function allows the factory values to be reset.

3.2. Intelia Latte customer and programming menu

Espresso coffee brew button
 Long espresso brew button
 "Aroma" - Pre-ground coffee button
 "MENU" button

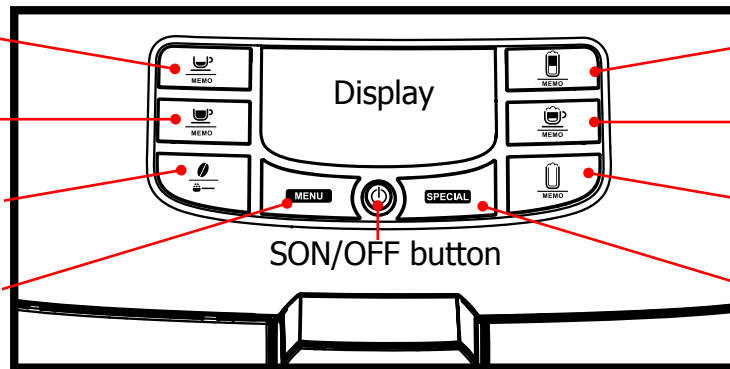

Latte Macchiato brew button
 Cappuccino brew button
 Hot Milk brew button
 Special beverages selection button

Ready signals (Green Colour)



The machine is ready to brew coffee.

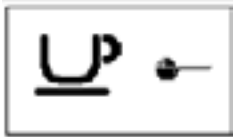

The machine is ready for brewing coffee by using preground coffee.



The machine is brewing 1 cup of espresso coffee.



The machine is brewing 1 cup of long espresso.



The machine is brewing 2 cups of espresso coffee.



The machine is brewing 2 cups of long espresso.



Hot milk brewing.



Milk dispensing phase during cappuccino preparation.



Coffee brewing phase during cappuccino preparation.

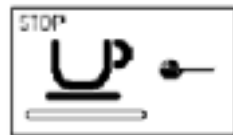

The machine is brewing 1 cup of espresso coffee by using ground coffee.



Milk dispensing phase during the preparation of the Latte Macchiato.



Coffee brewing phase during the preparation of the Latte Macchiato.



The machine is programming the amount of coffee to be brewed.



The machine is programming the amount of milk to be dispensed in order to prepare a cappuccino.



The machine is programming the amount of coffee to be brewed in order to prepare a cappuccino.



The machine is programming the amount of milk to be dispensed in order to prepare a hot milk.



The machine is programming the amount of milk to be dispensed in order to prepare a Latte Macchiato.



Insert the milk carafe and press the "MEMO" button to start the brewing and save. Press "MEMO" to exit.



The machine is programming the amount of coffee to be brewed in order to prepare a Latte Macchiato.

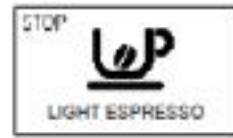

Brewing of a cup of "LIGHT ESPRESSO".



Brewing of a cup of "AMERICANO".



Hot water dispensing.



Brewing of a cup of "BABY CAPPUCCINO".

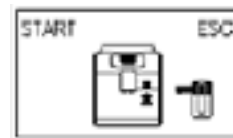

Insert the milk carafe and press the "MEMO" button to start the brewing. Press "MEMO" to exit.



Insert the water dispensing spout and press the "MEMO" button to start the dispensing. Press "MEMO" to exit.

Warning signals (Yellow Colour)



The machine is warming up to brew coffee and other products and to dispense hot water.



The machine is warming up to brew a product that is currently being programmed.



The Brew Group is being reset due to machine reset.

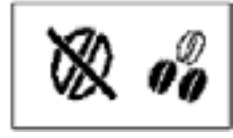

The machine is performing the rinse cycle. Wait until the machine stops the operation.



Prime the circuit.



The machine needs the "INTENZA+" filter to be replaced.



The machine reminds you to insert the carafe before going on with the descaling cycle.

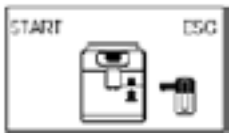

Insert the milk carafe and press the "MEMO" button to clean the carafe. Press "MEMO" to exit.

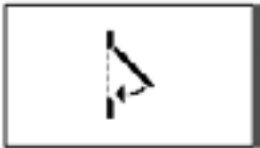

If this page is displayed after starting the machine, this means that the descaling cycle is needed. Press the "MEMO" button to enter the descaling menu and refer to the relevant section. Press the "MEMO" button to go on using the machine. Please bear in mind that failure to descale your machine will prevent it from working properly. Repair is not covered by warranty.

Warning signals (Read Colour)

Close the service door



Insert the coffee grounds drawer.



No coffee beans in the coffee bean hopper. After refilling the hopper, the cycle can be restarted.



Empty the coffee grounds drawer and the liquid recovery tray.



The Brew Group must be inserted into the machine.

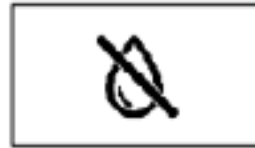

Fill the water tank.

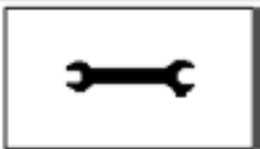

Turn off the machine. After 30 seconds, turn it on again. Try this 2 or 3 times.

If the machine does not start, contact the consumer care help line at the phone number listed on the last page of this document.



Insert the drip tray until it locks into place.

3.3. Intelia Focus and Class customer and programming menu

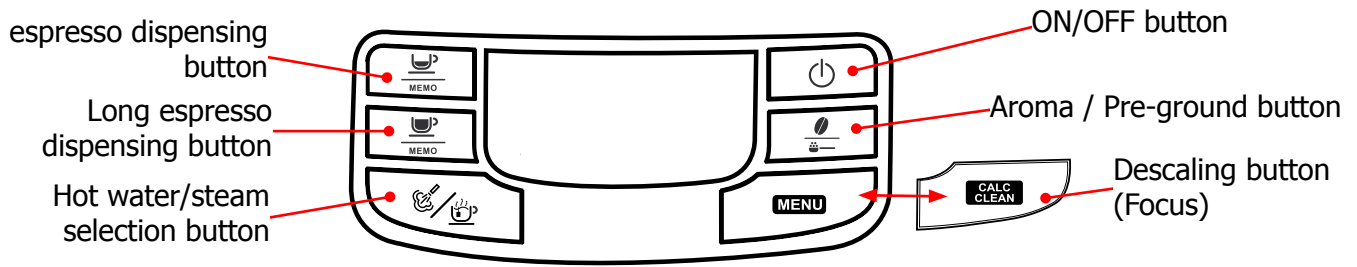

Machine ready signals (**GREEN**)

| | | | |
|--|--|--|---|
| | Machine at correct temperature - for coffee bean dispensing - for hot water dispensing | | Machine in phase for dispensing 1 cup of espresso |
| | Machine at correct temperature - for pre-ground coffee dispensing | | Machine in phase for dispensing 1 cup of espresso |
| | Hot water /steam selection | | Machine in phase for dispensing 2 cups of espresso |
| | Water dispense pipe (spout) | | Machine in phase for dispensing 2 cups of espresso |
| | Steam/water dispensing | | The machine is being programmed with the coffee cup fill level |

Notice signals (**ORANGE**)

| | | | |
|--|---|--|--|
| | Machine in pre-heating phase for coffee, hot water and steam dispensing | | Brewing unit resetting during appliance reset |
| | The appliance is rinsing - wait until end of operation | | Fill the coffee bean container and start the dispensing cycle |
| | The machine signals that the "INTENZA+" filter must be replaced | | Proceed to load the circuit |

If this screen appears after you switch the machine on, it means that you must execute a descaling cycle.

Press "MEMO" to access the descaling menu and consult the relative paragraph.
Press "ON/OFF" to continue using the machine.



Alarm signals (**RED**)

Close the service door.



Insert the dreg drawer.



No beans inside the coffee container.
After filling the container, the cycle can be restarted.



Empty the dreg drawer and the drip tray.



The Brewing Unit must be inserted in the machine.



Fill water tank.

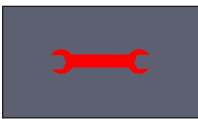

Switch the machine off, wait for 30 seconds. Repeat 2 or 3 times.
If the machine does NOT start, remove brewing unit, clean it, grease it and re-insert.
If the problem persists contact the service center.

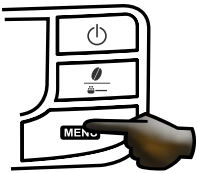
MENU (commands and programming)

The programming menu can be accessed only when the machine is switched on.
Press the menu button to access the programming menu.

**Coffee temperature (only Class)**

This function allows the coffee dispensing temperature to be adjusted.

**Timer (stand-by) (only Class)**

This function lets you adjust the time for switching to Stand By after the last dispensing.

**Contrast (only Class)**

This function lets you adjust the display contrast for better viewing of the messages.

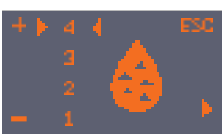
**Water hardness (Focus and Class)**

This function lets you adjust the water hardness so that machine maintenance is managed better:

1 = very soft water 2 = soft water 3 = hard water 4 = very hard water

**"INTENZA+" water filter (Focus and Class)**

This function lets you manage the "INTENZA+" water filter.

For details see the paragraph concerning the filter management.

**Descaling Cycle (Focus and Class)**

This function lets you execute a descaling cycle.

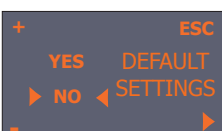
**Factory settings (only Class)**

This function allows the factory values to be reset.

3.4. Intuita customer and programming menu

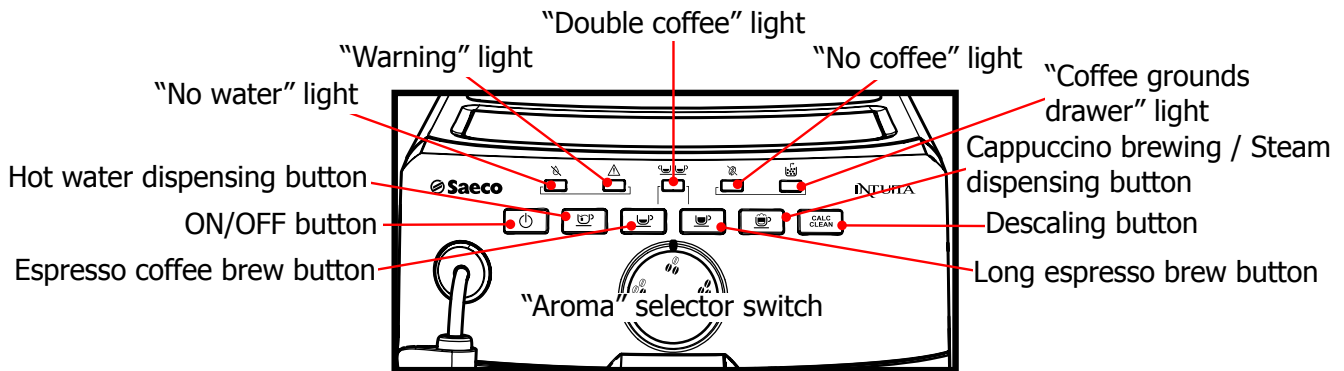

BLINKING
Machine in Stand-by.



STEADY ON
The machine is brewing 2 cups of espresso coffee.



BLINKING
The machine is performing the rinse cycle.



STEADY ON
The machine is brewing 1 cup of coffee.

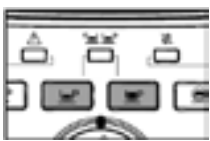

BLINKING
The machine is in the warm-up phase.



STEADY ON
The machine is brewing 2 cups of coffee.

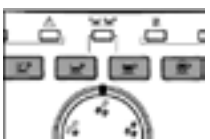

STEADY ON
The machine is ready for use.



BLINKING
The machine is reprogramming the amount of coffee necessary to brew a cup of espresso coffee.



STEADY ON
Hot water is being dispensed.



BLINKING
The machine is reprogramming the amount of coffee necessary to brew a cup of coffee.



STEADY ON
The machine is brewing 1 cup of espresso coffee.

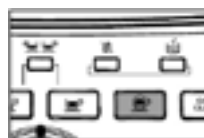

STEADY ON
Steam is being dispensed.

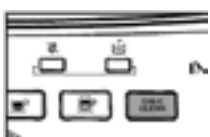

STEADY ON
The machine needs a descaling cycle. Please bear in mind that failure to descale your machine will prevent it from working properly. Repair is not covered by warranty.

Alarm signals



BLINKING
Prime the circuit.

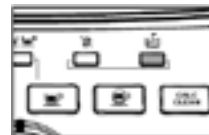

BLINKING
Insert the coffee grounds drawer.



BLINKING
Close the service door. The Brew Group must be inserted into the machine.

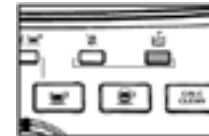

FAST BLINKING
Empty the coffee grounds drawer and the liquid recovery tray.



STEADY ON
No coffee beans in the coffee bean hopper. After refilling the hopper, the cycle can be restarted.



STEADY ON
Fill the water tank.

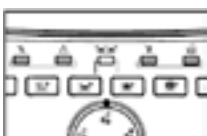

BLINKING
Turn off the coffee machine. After 30 seconds, turn it on again. Try this 2 or 3 times. If the machine does not start, contact the consumer care help line at the phone number listed on the last page of this document.

3.5. Operation, cleaning and maintenance

| Operating the machine | | |
|-----------------------|---|---|
| 1 | Fill water tank | |
| 2 | Fill the coffee bean hopper | |
| 3 | Switch on the appliance | |
| 4 | Press the button to start the appliance |  |
| 5 | Heating | When the heating phase begins, wait for it to finish |
| 6 | Rinse | Carry out a rinse cycle for the internal circuits |
| 7 | Machine ready | The machine is ready to dispense beverages |

| CLEANING AND TECHNICAL SERVICING | | |
|----------------------------------|------------------------------|---|
| A | Empty the dregs drawer | When indicated |
| B | Empty the drip tray | As necessary |
| C | Clean the water tank | Weekly |
| D | Clean the coffee bean hopper | As necessary |
| E | Clean the casing | As necessary |
| F | Clean the brewing unit | Every time the coffee bean hopper is filled or weekly |
| | Lubricate the brewing unit | After 500 dispensing cycles or when the grease is no longer present on the brewing unit |
| | Clean the unit housing | Weekly |
| H | Descaling | When indicated |

| Descaling cycle frequency | | | |
|---------------------------|------------------------|-----------------------------|-----------------------------|
| Hardness | Water hardness | Without water filter | With water filter |
| 1 | Soft (up to 7°dH) | 240 litres (480,000 pulses) | 480 litres (960,000 pulses) |
| 2 | Medium (7° - 14°dH) | 120 litres (240,000 pulses) | 240 litres (480,000 pulses) |
| 3 | Hard (15° - 21°dH) | 60 litres (120,000 pulses) | 120 litres (240,000 pulses) |
| 4 | Very hard (over 21°dH) | 30 litres (60,000 pulses) | 60 litres (120,000 pulses) |

The default water hardness level is 4. Each litre of water corresponds to approximately 2,000 pulses.

In the machines where is not possible change the water hardness the default hardness level is 3.



CHAPTER 4

OPERATING LOGIC

4.1. Water circuit

Intelcia Cappuccino

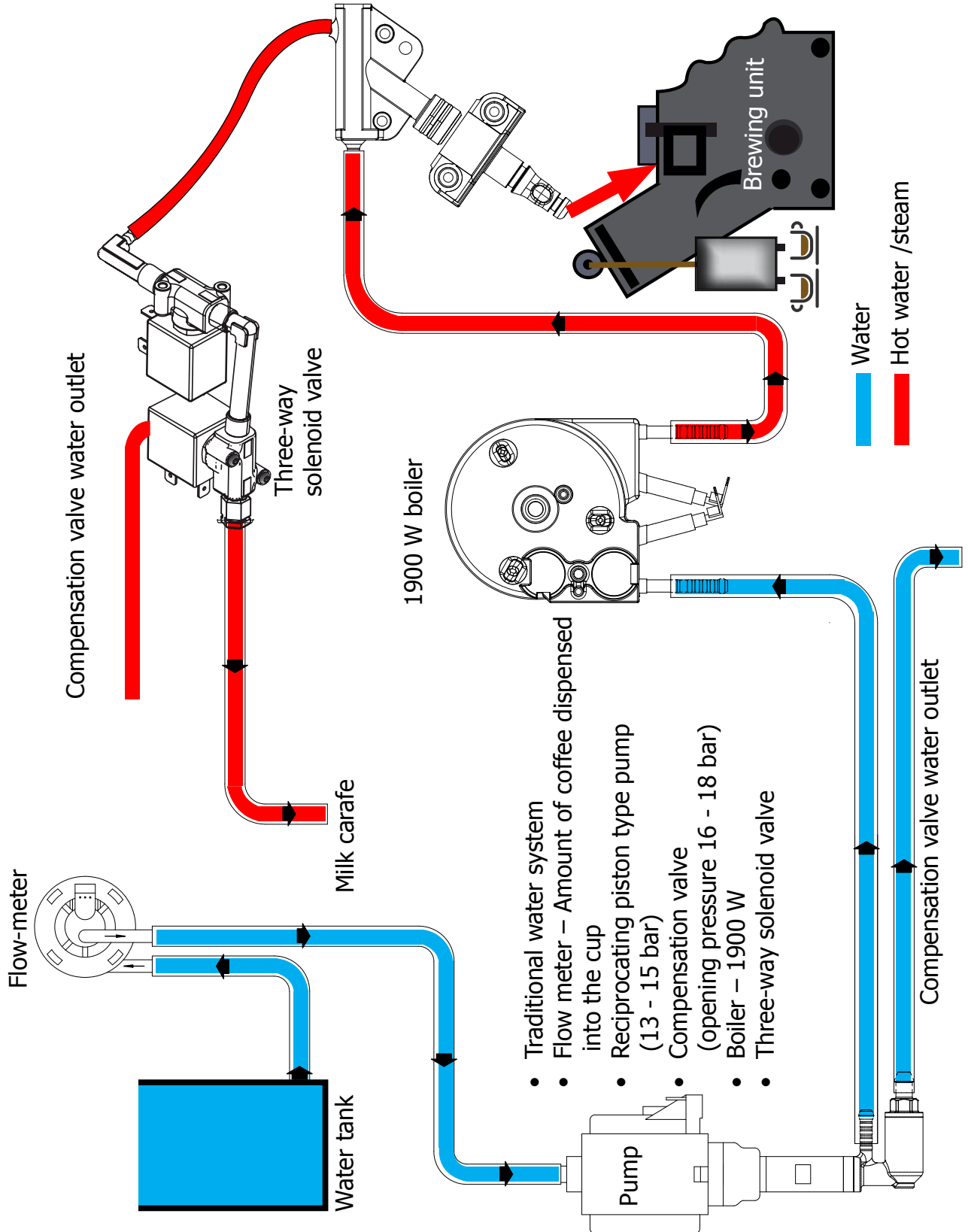

Intelia Cappuccino V2

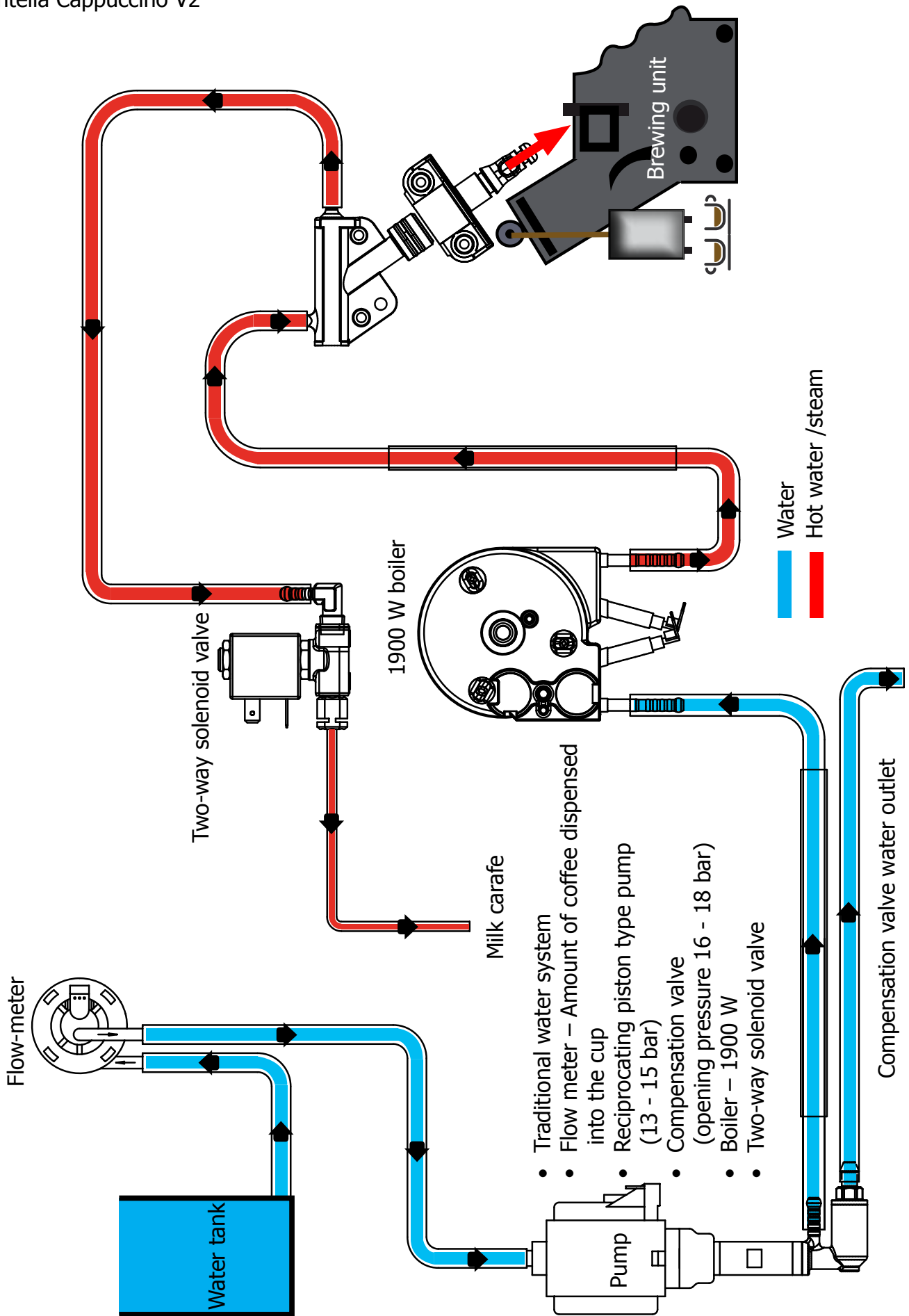

- Traditional water system
- Flow meter – Amount of coffee dispensed into the cup
- Reciprocating piston type pump (13 - 15 bar)
- Compensation valve (opening pressure 16 - 18 bar)
- Boiler – 1900 W
- Two-way solenoid valve

Intelia Focus e Class

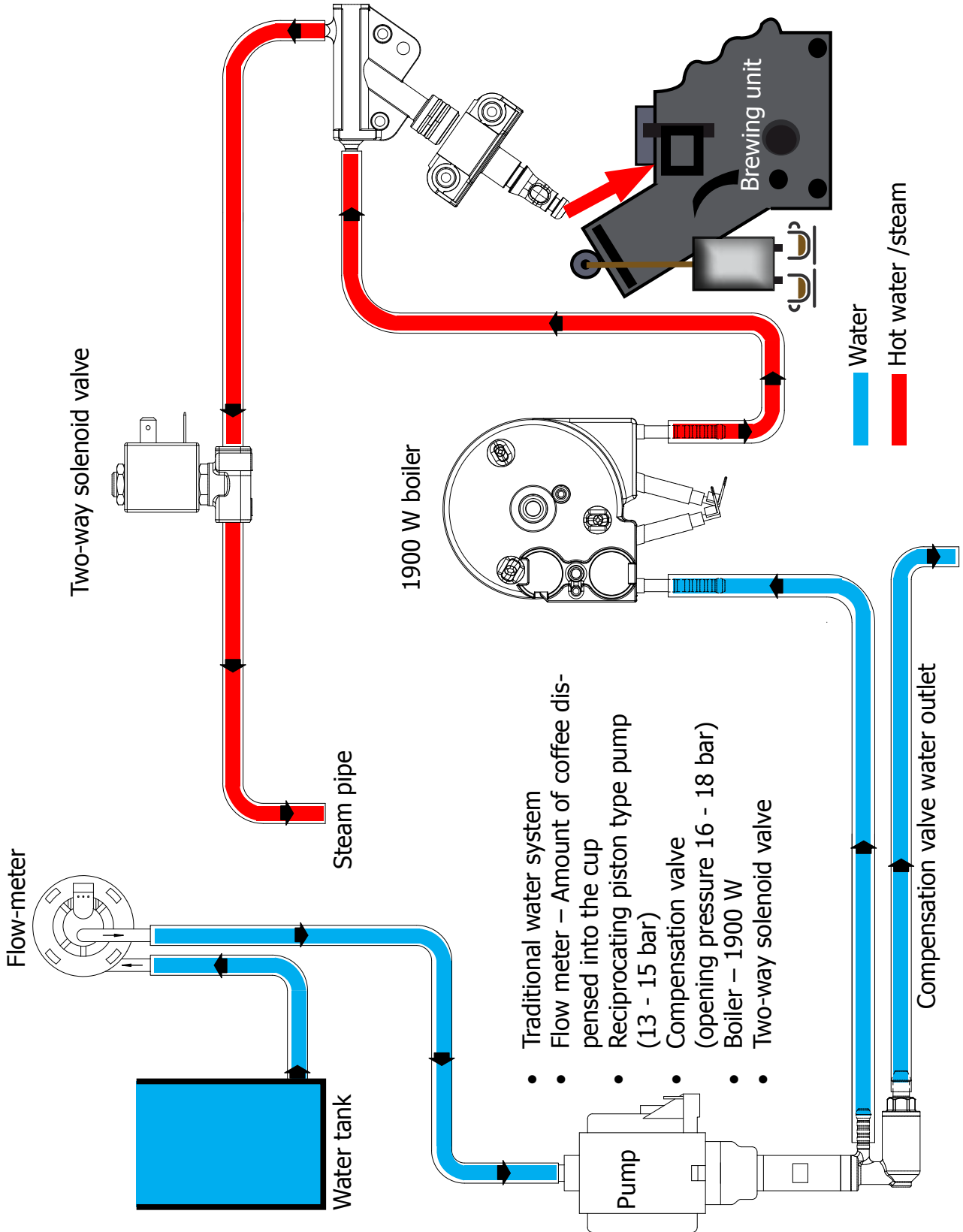

- Traditional water system
- Flow meter – Amount of coffee dispensed into the cup
- Reciprocating piston type pump (13 - 15 bar)
- Compensation valve (opening pressure 16 - 18 bar)
- Boiler – 1900 W
- Two-way solenoid valve

4.2. Coffee cycle

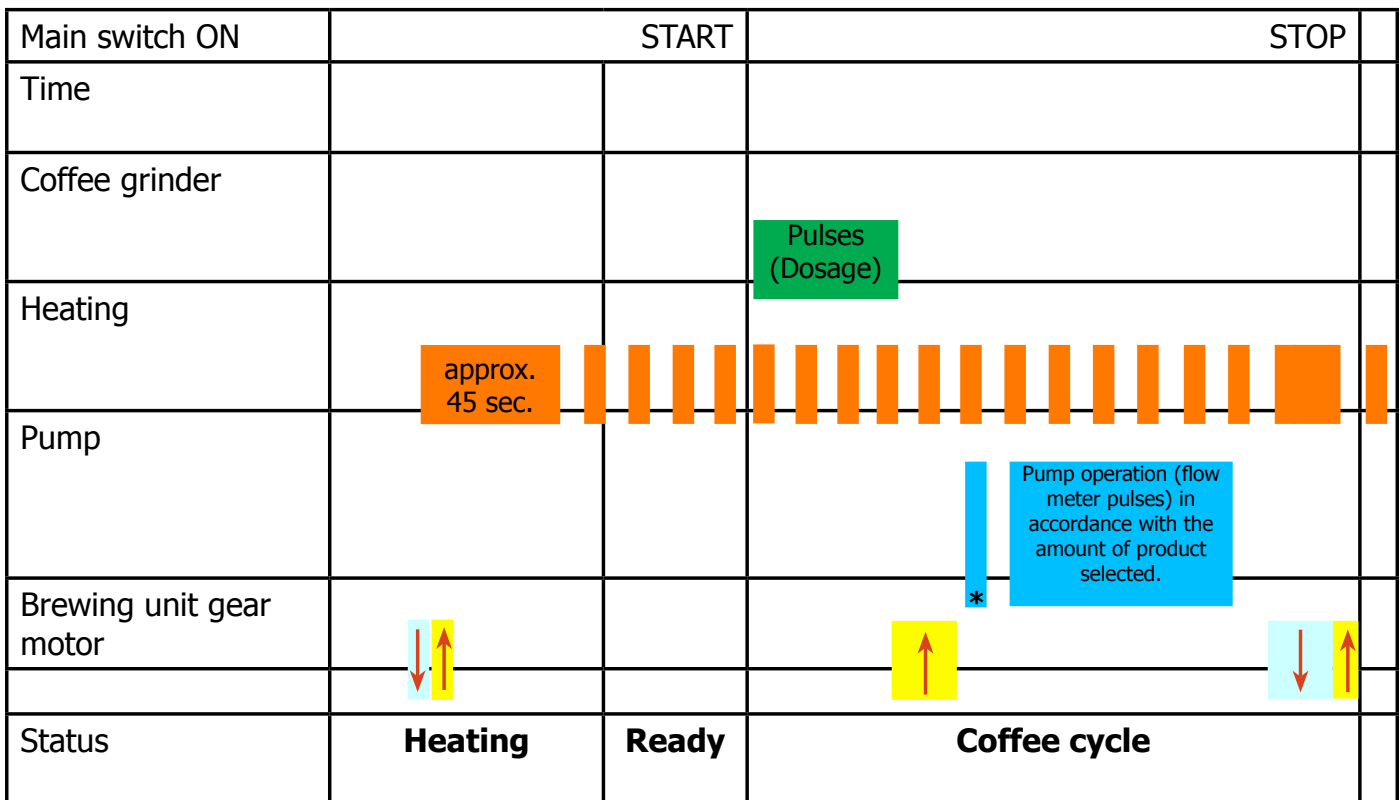

Notes: * Only with Pre-brewing



Single microswitch gear motor

Switching on

When the machine is switched on, the gear motor repositions itself as follows:

- It acts on microswitch 1 (see following chapter).
- The gear motor changes its rotation direction and moves upwards again by approx. 1-2 mm.
- The boiler begins to heat the water for approx. 45 sec., at full power, in order to reach the optimal temperature. The temperature will then remain at a constant level.

Coffee cycle

1. The coffee grinder starts the grinding process (controlled by pulses generated by a sensor).
2. The gear motor (brewing unit) moves to the brewing position.
3. Preliminary dispensing phase (short pump activity, short pause).
4. Product dispensing (the pump operation period is defined by the amount of product dispensed).
5. The gear motor moves to its home position (the dregs are expelled automatically).

4.3. Single microswitch

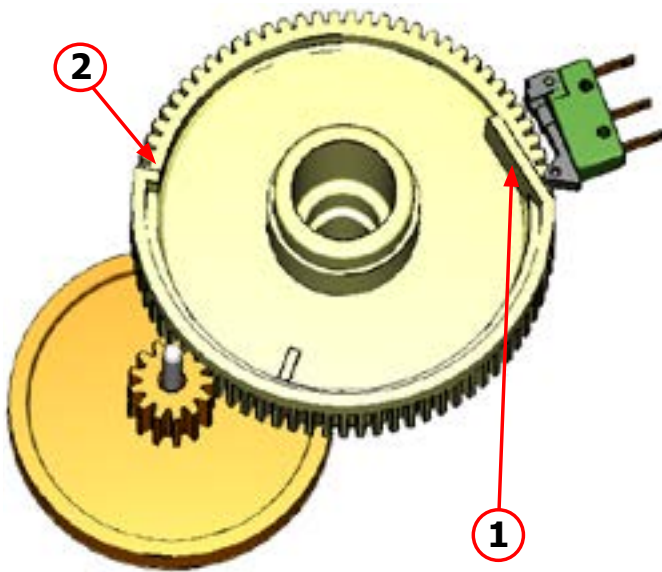

The gear motor is powered by a direct current motor that engages with the smaller double toothed wheel using a worm screw. The unit is mounted on the axle of the large gear wheel and when a coffee is requested, it moves from the standby position to the dispensing position, and then back to the standby position again.

- **Standby position: 1**

- **Dispensing position: 2**

4.4. Temperature sensor (adjustment)

| Temp. (°C) | R nom (kΩ) | ΔR (+/- %) |
|------------|------------|------------|
| 20 | 61.465 | 8.6 |
| 50 | 17.599 | 5.9 |
| 75 | 7.214 | 4.1 |
| 80 | 6.121 | 3.7 |
| 85 | 5.213 | 3.4 |
| 90 | 4.459 | 3.1 |
| 100 | 3.3 | 2.5 |
| 125 | 1.653 | 3.9 |
| 150 | 0.893 | 5.1 |

An NTC is used as a temperature sensor; in the event of overheating this reduces boiler element power consumption.

The electronic system detects the current boiler temperature from the drop in voltage of the sensor and adjusts it accordingly.

Heating element values and corresponding temperatures: see table.

4.5. Coffee grinder

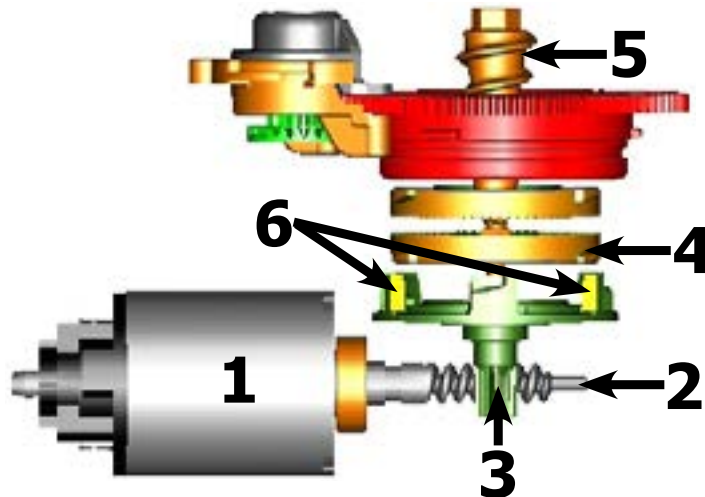

The coffee grinder is driven by a direct current motor (1) using a worm screw helical wheel transmission (2).

The worm screw (2) drives a plastic gear wheel (3), which turns the lower grinder (4) and the increment pin (5)

There are two magnets (6) in the gear wheel; at every rotation these induce two pulses to a Hall sensor, which in turn transmits them to the electronic system.

4.6. Low bean level detection, dose quantity adjustment, coffee grinder blocked

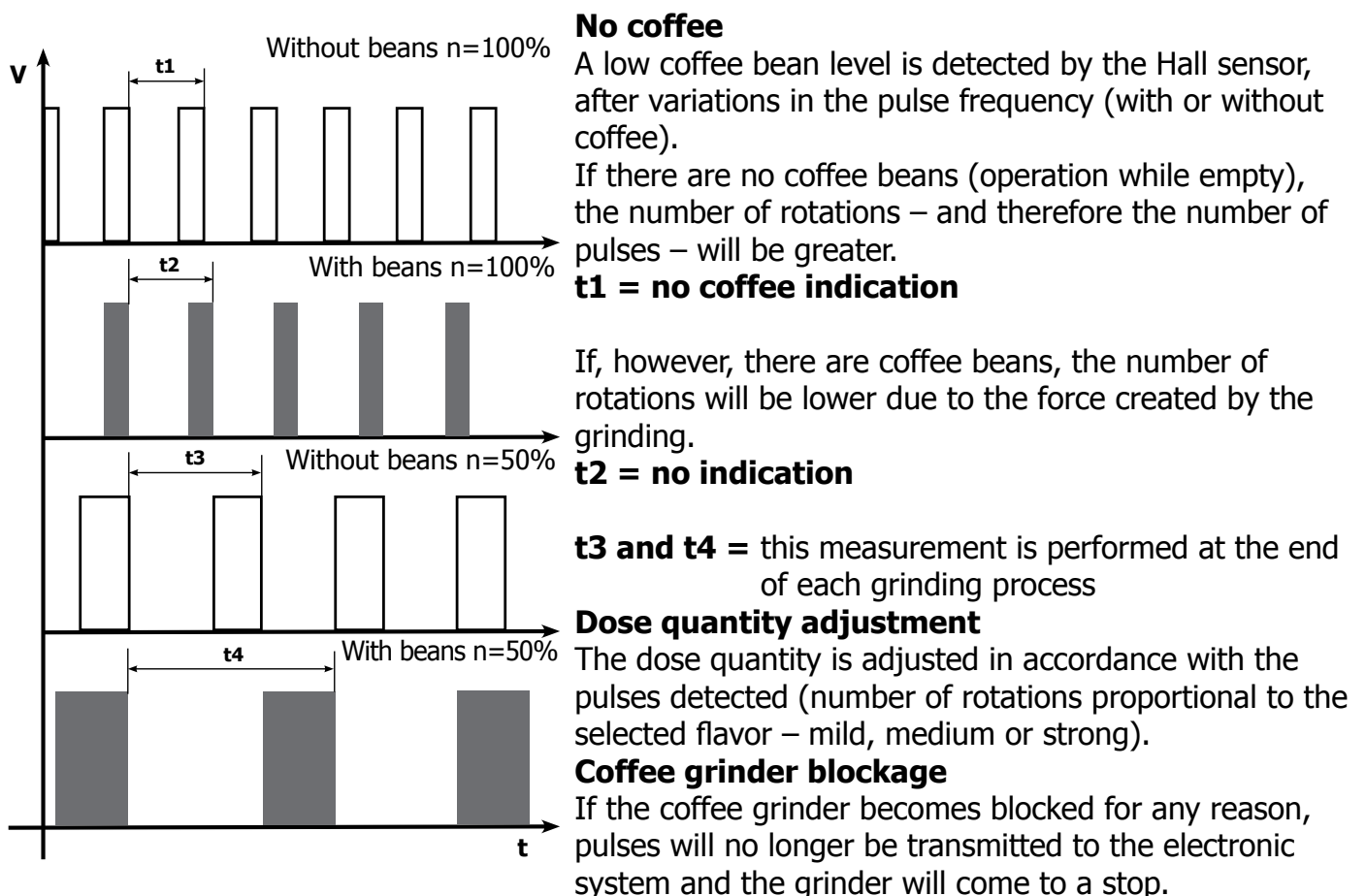

4.7. Dose self-learning (SAS)

The aim of this function is to automatically regulate the average dose of ground coffee (SELF-LEARNING); this takes place with an algorithm based on three pieces of data that the machine receives via the card:

1. Number of coffee grinder pulses during the grinding cycle.
2. Max. average value of the power consumed by the gear motor during the coffee brewing cycle.
3. Aroma selected by the user.

The algorithm compares the maximum average value of the power consumed by the gear motor with the value listed in the table for the selected aroma, in order to calculate the new grinding pulse value for the next coffee produced.

If the power consumption value is less than the minimum current value, the grinding pulses will be increased by 2.

If the power consumption value is greater than the maximum current value, the grinding pulses will be decreased by 4.

If the power consumption value falls within the "over-torque" interval, the product will be dispensed and the grinding pulses will be decreased by 10.

If the power consumption value falls within the "abort cycle" interval, the dreg will be expelled and the grinding pulses will be decreased by 10.

If the "pre-ground" flavour is selected by the user, no modification will be made.

This guarantees that, regardless of the coffee type used, the grinding level setting and the wear on the grinders, the ground coffee dose always remains constant.

| Setting/Status | | Power consumption in mA | Pulses corrected in the next grinding process | |
|----------------|----------------|-------------------------|---|--|
| | | | In the event of absorption above the range | In the event of absorption below the range |
| A | Mild aroma | 200 - 300 mA | - 4 | +2 |
| B | Medium Aroma | 301 - 450 mA | - 4 | +2 |
| C | Strong Aroma | 451 - 600 mA | - 4 | +2 |
| D | Over-limit | 601 - 800 mA | - 4 | |
| E | Overwork | 801 - 1000 mA | - 10 | |
| F | Dreg expulsion | > 1000 mA | - 10 | |

Important:

For perfect operation, machine adjustment should take place in the area of the fields highlighted in green (A, B, C). When the type or brand of coffee is changed, there may be variations in the size of the beans and their stickiness or roasting level. This leads to variations in power consumption (mA), with resulting excessive or insufficient doses (until the necessary adjustments have been made to compensate for this change).

Caution: In the case of excessive dosage, powder may be expelled into the dreg drawer. This is not a fault, but can occur during preliminary operation or after a service.

4.8. Water level detection (water tank)

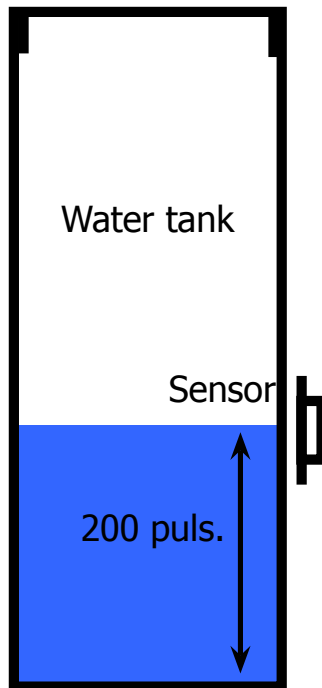

“Water low” message (water reserve)

Function:

The water level is monitored by a capacitive sensor, located one third of the way up the water tank wall.

If the electronics assembly detects, by means of the sensor, that the amount of water in the tank has dropped below the above mentioned level, a water reserve remains available for the dispensing process underway (this will cover 200 flow meter pulses).

The product dispensing process will then come to an end.

If a dispensing cycle ends after the sensor has been triggered (in the reserve) then the display “Water low” continues to be displayed during the following dispensing cycle.

4.9. Descaling request

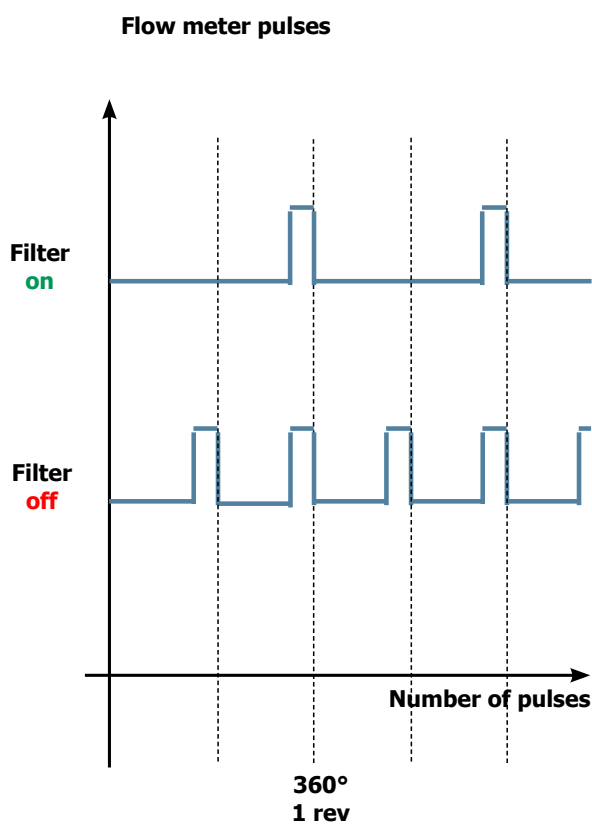

“Descaling” – message with water filter inserted

(appliances with display only)

The water hardness is set on the basis of the regional water hardness analysis (1, 2, 3, 4).

Filter off:

If the function is turned off the electronics assembly monitors the flow meter pulses, recording one pulse each turn.

Filter on:

If the function is turned on the electronics assembly monitors the flow meter pulses, recording one pulse every two turns.

“Change water filter” message

The electronics assembly uses the flow meter impulses to keep track of the amount of water which has flowed through; after the specified amount (set in accordance with the water hardness level), the “Replace filter” message appears.

4.10. Water filter

Water filter

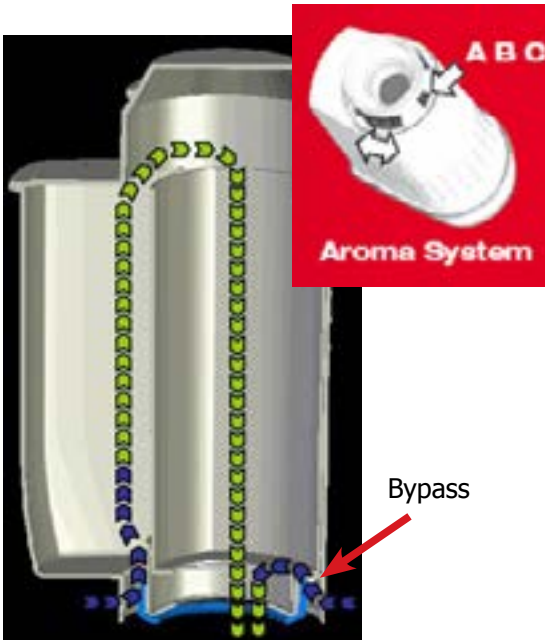

Function:

- Reduced limescale deposits which take longer to form.
- Improved water quality.
- Improved taste due to the ideal water hardness.

Life span / descaling performance:

- - 10 ° dH
- 60 litres
- 2 months

To achieve the best possible operating mode consistency over the total life span, the water is channelled using a 3-stage bypass (A, B, C) depending on the degree of hardness. See small image.

4.11. Intelia Cappuccino milk carafe

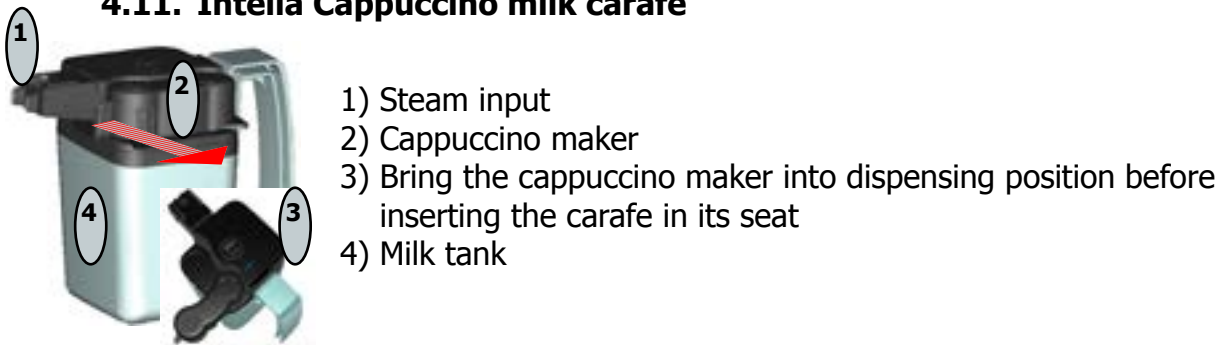

Emulsion chamber

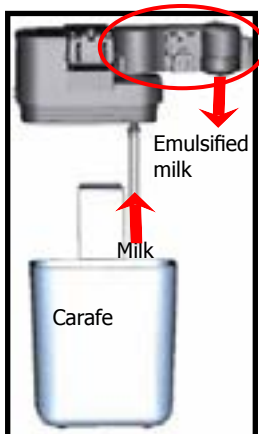
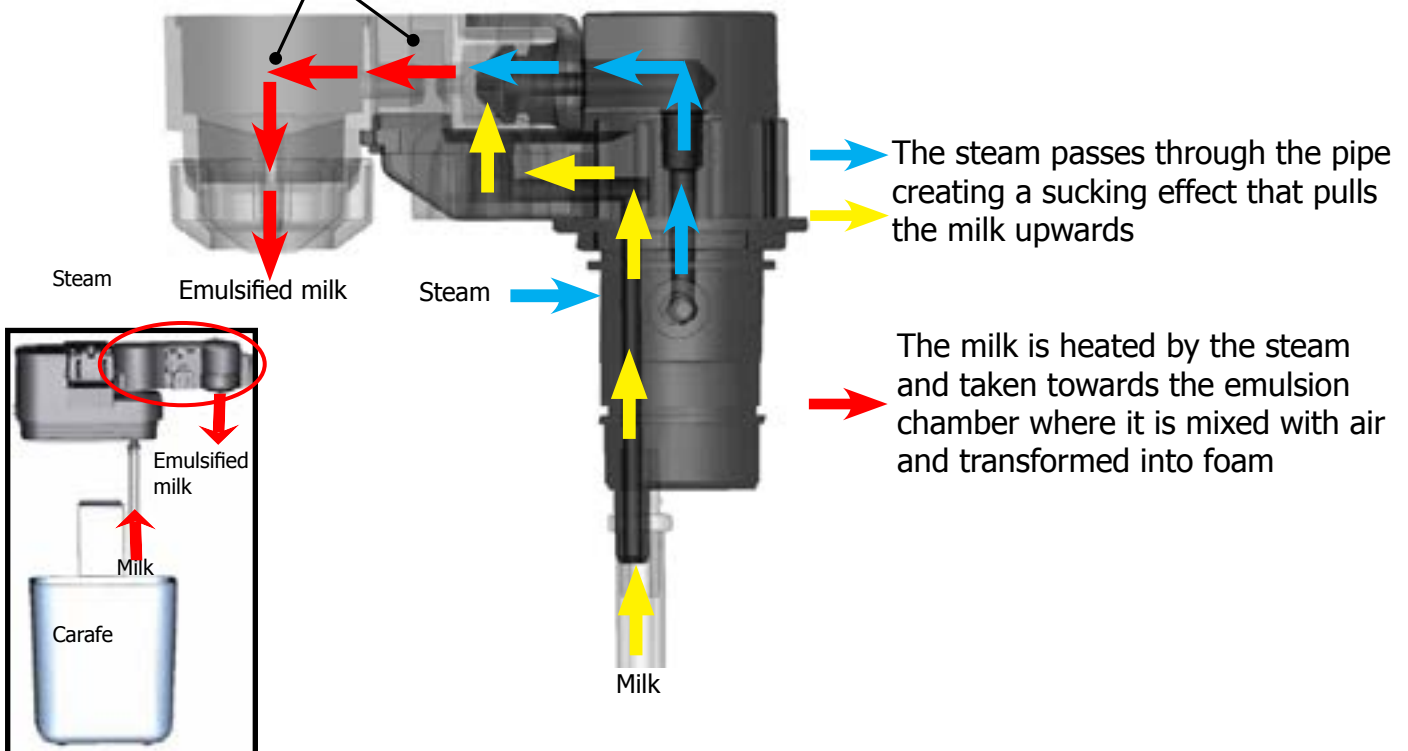



CHAPTER 5

TROUBLESHOOTING

5.1.1. Intelia Cappuccino test mode

To enter Test Mode

1. Hold down the buttons Espresso and Menu.
2. Turn on the main switch at the rear of the machine

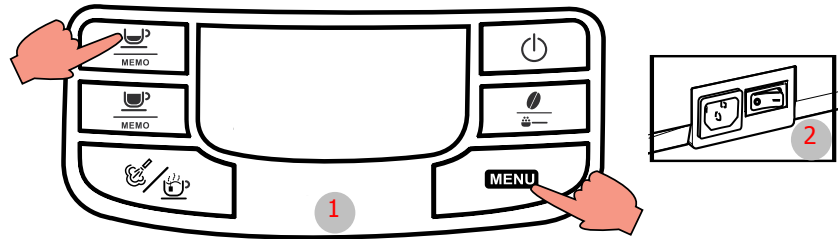

Entry into Test Mode results in a screen divided into sections, as illustrated in the diagram below.

Firmware Software version



Shows the version of the firmware loaded and the internal checksum (it gives univocal traceability)

Press STAND_BY "⏻" to move to the next screen

Operational check – keys



Initial status



The letter next to it changes from N to Y when only one button is pressed. By pressing buttons 1, 3, 4, 6 the display color changes from GREEN to RED. By pressing buttons 2, 5 and 7 the display color changes from GREEN to YELLOW.



Button 4 must be pressed at the end only once, since pressing it moves on to the next page.

ERROR condition:

The letters do not change from N to Y or are always Y, in this case check the flat communication cable with the Control Board/Power Board, if it does not change color check the cable JP4 too.

Press STAND_BY "⏻" to move to the next screen

Operational check microswitches and sensors



Initial status.



Insert full water tank

The TANK-H20 indicator must change from "N" to "Y"

ERROR Condition:

If the indication does not change, check the capacitive sensor and relative wiring (JP23).



Insert the dreg drawer

The DREG indicator must change from "N" to "Y"

ERROR Condition:

If the indication does not change, check the microswitch on the dreg drawer and relative wiring (JP16).

| INPUTS | | | |
|-------------|---------|--|--|
| TANK-H2O= Y | DOOR= Y | | |
| DREG= Y | BU-P= N | | |
| COM= USCP | TRAY= N | | |

Close the side door (the dreg drawer must already be in position)
The DOOR indicator must change from "N" to "Y"

ERROR condition:

If the indication does not change, check the Microswitch on the hatch and relative wiring (JP14), make sure that the dreg drawer is correctly in position.

| INPUTS | | | |
|-------------|---------|--|--|
| TANK-H2O= Y | DOOR= Y | | |
| DREG= Y | BU-P= Y | | |
| COM= USCP | TRAY= N | | |

Insert the brewing unit

The BU-P indicator must change from "N" to "Y"

ERROR Condition:

If the indication does not change, check the brewing unit microswitch and relative wiring (JP16).

| INPUTS | | | |
|-------------|---------|--|--|
| TANK-H2O= Y | DOOR= Y | | |
| DREG= Y | BU-P= Y | | |
| COM= USCP | TRAY= Y | | |

Insert the dreg drawer

The TRAY indicator must change from "N" to "Y"

ERROR Condition:

If the indication does not change, check the brewing unit microswitch and relative wiring (JP4).

| INPUTS | | | |
|-------------|---------|--|--|
| TANK-H2O= Y | DOOR= Y | | |
| DREG= Y | BU-P= Y | | |
| COM= USCP | TRAY= N | | |

The COM indicator must be left on USCP.

Press STAND_BY "  " to move to the next screen

Operational check - milk inputs

| INPUTS MILK | | | |
|-------------|--------|--|--|
| CARAFE= N | TAP= N | | |

Initial status

| INPUTS MILK | | | |
|-------------|--------|--|--|
| CARAFE= Y | TAP= N | | |

Insert the Carafe

The CARAFE indicator must change from "N" to "Y"

ERROR Condition:

If the indication does not change, check the brewing unit microswitch and relative wiring (JP25).

| INPUTS MILK | | | |
|-------------|--------|--|--|
| CARAFE= N | TAP= Y | | |

Insert the Water Coupling

The TAP indicator must change from "N" to "Y"

ERROR Condition:

If the indication does not change, check the brewing unit microswitch and relative wiring (JP25).

Press STAND_BY "  " to move to the next screen

Operational check – brewing unit

| BU PAGE | | | |
|---------|--------|--|--|
| WORK= N | CUR= 0 | | |
| HOME= N | | | |

Initial status



Press the ESPRESSO button to move the unit to Work position. When the unit is in position, the WORK indication changes from "N" to "Y", the absorption current must be less than 200mA without the brewing unit on, and less than 300mA with the brewing unit on.



The WORK indicator remains permanently on "N"

ERROR condition:

The WORK indicator changes, and remains permanently on "N", while the backlight changes from green to red; check the microswitch, unit motor (this may be blocked) and lastly the wiring JP16 and JP14.



ERROR condition:

(without brewing unit):

If the absorbed current exceeds 200 mA the display turns red, check the gears on the motor and the motor housing in its seat.



ERROR condition:

(with brewing unit):

If the absorbed current exceeds 300 mA the display turns red, check the brewing unit, the gears on the motor and the motor housing in its seat.



Press the COFFEE button to shift the unit into Home position. When the unit reaches HOME position the indication changes from "N" to "Y", the absorption current must be less than 200mA without the unit or less than 300 mA with the unit on.



The HOME indicator remains permanently on "N"

ERROR condition:

The HOME indicator changes, and remains permanently on "N", while the display changes from green to red; check the microswitch, unit motor (this may be blocked) and lastly the wiring JP16 and JP14.



ERROR condition:

(without brewing unit):

If the absorbed current exceeds 200 mA the display turns red, check the gears on the motor and the motor housing in its seat.



ERROR condition:

(with brewing unit):

If the absorbed current exceeds 300 mA the display turns red, check the brewing unit, the gears on the motor and the motor housing in its seat.

Press STAND_BY "  " to move to the next screen

Operational check - solenoid valves and pump

Initial Status



If the following screen appears it means that the dreg drawer is not correctly inserted, or that the side door is not completely closed. The screen will disappear only after the drawer has been inserted or the door closed.

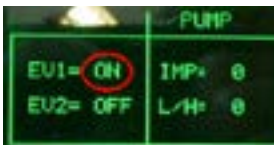

Press the ESPRESSO button to activate solenoid valve EV1 (2-way, normally closed).

The solenoid valve is activated and the indication to the right of EV1 changes from "OFF" to "ON".



Press the COFFEE button to activate solenoid valve EV2 (3-way, normally open).

The solenoid valve is activated and the indication to the right of EV2 changes from "OFF" to "ON".



Press the AROMA button to activate solenoid valve EV2 (3-way, normally open).

The water is dispensed from the steam pipe. IMP indicates an increasing number of pulses. L/H must be between 10 and 18.



ERROR:

The pulses remain at 0, the display turns red, this means there is an error in the water circuit. If water is coming out of the coupling, it means there is an error in the flow meter or in its wiring in the Control Board/Power Board (JP5). If no water is coming out, check the pump, the connected water circuit, or the pump wiring (JP24).

New version with a solenoid valve

Press the ESPRESSO button to activate solenoid valve EV1.

The solenoid valve is activated and the indication to the right of EV1 changes from "OFF" to "ON".



ERROR:

The pulses remain at 0, the display turns red, this means there is an error in the water circuit. If water is coming out of the coupling, it means there is an error in the flow meter or in its wiring in the Control Board/Power Board (JP5). If no water is coming out, check the pump, the connected water circuit, or the pump wiring (JP24).

Press STAND_BY "  " to move to the next screen

Operational check - coffee grinder and boiler

Initial status

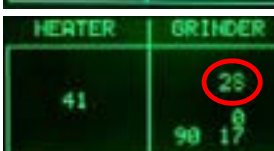

Press Aroma to switch on the grinder

The coffee grinder starts to spin and the number of pulses is indicated by the number circled in red, the other numbers have no significance for this test.

**ERROR:**

If the number remains 0, the display turns red, and the motor is running, the problem lies in the Hall sensors, or their wiring, or in the Control Board/Power Board input (JP2). If the motor does not run, the problem may lie in the chain (JP8), the coffee grinder wiring or the actual coffee grinder.

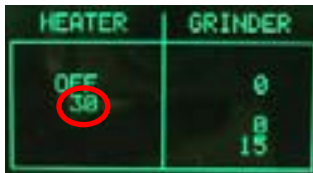
**Temperature control**

The circled number expresses the boiler temperature in degrees centigrade.

**ERROR:**

If the HEATER indicator shows the word "SHORT", this means that the NTC temperature sensor is in short circuit and the display turns from green to red. In this case, check the wiring of the NTC or the Control Board/Power Board (JP13).

**ERROR:**

If the HEATER indicator shows the word "OPEN", this means that the NTC temperature sensor is disconnected, the display turns from green to red.

In this case, check the continuity of the NTC wiring and check the connection to the Control Board/Power Board (JP13).

Press the COFFEE button to activate the Boiler

The indicator changes from "OFF" to "ON" and shortly after the temperature indicator should start to increase, and any ammeter at the technician's disposal on the counter must display an absorption of approximately 8 Ampere with 230 volt.

**ERROR:**

If the temperature is not absorbed check the boiler resistor, relative wiring and the connection to the Control Board/Power Board input (JP19), also check the wiring on the NTC (JP13).



If the temperature goes above 125°C then the display turns yellow and an alarm message appears on the display.

Above this temperature the boiler is always off, avoiding the risk of dangerously high temperatures.

5.1.2. Intelia Focus and Class Test mode

To enter Test Mode

1. Hold down the Espresso and Menu buttons.
2. Switch on the main switch at the back of the machine.

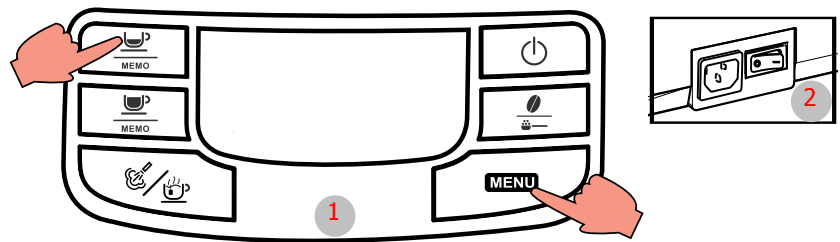

Entry into Test Mode results in a screen divided into sections, as illustrated in the diagram below.

Firmware Software version



Shows the version of the firmware loaded for Focus and Class.

Press STAND_BY "⏻" to move to the next screen

Operational check – keys



Initial status



The letter next to it changes from N to Y only when a button is pressed. By pressing buttons 1, 3, 4, 6 the display color changes from GREEN to RED. By pressing buttons 2, 5, the display color changes from GREEN to YELLOW. Button 4 must be pressed at the end only once as when pressed it moves to the next page.



ERROR condition:

The letters do not change from N to Y or are always Y, in this case check the flat communication cable with the power board -Power JP21, if it does not change color check the cable JP4 between the board and the display.

Press STAND_BY "⏻" to move to the next screen

Operational check microswitches and sensors



Initial status.

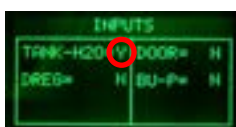

If you insert a full drip tray the TANK-H2O indicator must change from "N" to "Y".
ERROR condition:
 If the indication does not change, check the capacitive sensor and relative wiring (JP23).



Insert grounds drawer

The DREG indicator must change from "N" to "Y"

ERROR condition:

If the indication does not change, check the microswitch on the dreg drawer and relative wiring (JP16).



Close the side hatch (the dreg drawer must be inserted)

The DOOR indicator must change from "N" to "Y"

ERROR condition:

If the indication does not change, check the Microswitch on the hatch and relative wiring (JP14), make sure that the dreg drawer is correctly in position.



Insert the brewing unit

The BU-P indicator must change from "N" to "Y"

(this step takes 2-3 sec)

ERROR condition:

If the indication does not change, check the brewing unit microswitch and relative wiring (JP16)

Press STAND_BY "⏻" to move to the next screen

Operational check – brewing unit



Initial status

IMPORTANT: This check can only be carried out with the dreg drawer in and the side hatch closed

Press the espresso button to move the brewing unit to the "WORK" position



When the unit is in position, the WORK indication changes from "N" to "Y", the absorption current must be less than 200mA without the brewing unit on, and less than 300mA with the brewing unit on.

ERROR condition:

The WORK indicator always stays on "N"

ERROR:

The WORK indicator changes, and remains permanently on "N", while the display changes from green to red; check the microswitch, the motor of the gear motor (this may be blocked) and the wiring JP16.



ERROR (without brewing unit):

If the absorbed current exceeds 200 mA the display turns red, check the gears on the gear motor and the motor housing in its seat.



ERROR (with brewing unit):

If the absorbed current exceeds 300 mA the display turns red, check the brewing unit, the gears on the gear motor and the motor housing in its seat.



Press the espresso button to move the brewing unit to the "HOME" position



When the unit reaches the HOME position the indicator changes from "N" to "Y", the absorbed current, without the brewing unit, must be less than 200, and with the brewing unit less than 300 mA

ERROR condition:

The HOME indicator always stays on "N"

ERROR:

The HOME indicator changes, and remains permanently on "N", while the display changes from green to red; check the microswitch, unit motor (this may be blocked) and the wiring JP16.



ERROR (without brewing unit):

If the absorbed current exceeds 200 mA the display turns red, check the gears on the gear motor and the motor housing in its seat.



ERROR (with brewing unit):

If the absorbed current exceeds 300 mA the display turns red, check the brewing unit, the gears on the gear motor and the motor housing in its seat.



Press STAND_BY "  " to move to the next screen

Operational check - solenoid valve and pump



Initial status

Press the espresso button to activate the solenoid valve

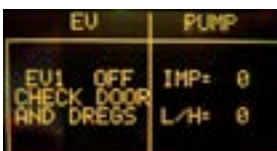

If the dreg drawer is in position and the side hatch closed, the EV cannot be done. If it is not in the right position, a warning message is shown on the display, which turns yellow.



The indication next to EV1 changes from "OFF" to "ON". You can hear the "click" of the solenoid valve.



Press the aroma button to activate the pump

The water is dispensed from the steam pipe IMP indicates an increasing number of pulses. L/H must be between 10 and 18.



ERROR: The back-lit green display changes to red and the pulse remains 0 even if water comes out of the steam pipe, check the wiring on the flow meter (JP5). If water does not come out of the steam pipe, check the pump and the pump wiring (JP24).



ERROR: If L / H is 0 or very low, the solenoid valve does not open. Check the solenoid valve and the wiring (JP3).

Press STAND_BY "  " to move to the next screen

Operational check - coffee grinder and boiler



Initial Status

Press the aroma button to activate the coffee grinder



The coffee grinder starts to spin and the number of pulses is indicated by the number circled in red, the other numbers have no significance for this test.



ERROR:

If the number remains 0, the display changes to red, and the motor runs, the problem lies in the Hall sensors, or their wiring, or in the CPU/POWER input (JP2). If the motor does not run, the problem may lie in the chain (JP8), the coffee grinder wiring or the actual coffee grinder.

Temperature control

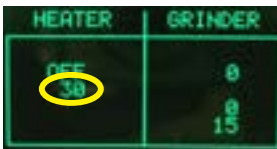

The circled number expresses the boiler temperature in degrees centigrade.



ERROR:

If the HEATER indicator shows the word "SHORT", this means that the NTC temperature sensor is in short circuit. The display changes from green to red: in this case check the wiring on the NTC or the CPU/POWER inlet (JP13).

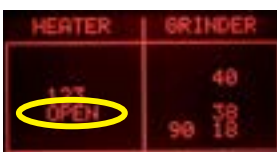

ERROR:

If the HEATER indicator displays the word "OPEN", this means that the NTC temperature sensor is disconnected; the display changes from green to red; in this case check the continuity of the NTC wiring, and check the connection to the CPU/POWER in (JP13).

Press the espresso button to activate the boiler



The indicator changes from "OFF" to "ON" and shortly after the temperature indicator should start to increase, and the ammeter on the counter must display an absorption of approximately 8 Ampere with 230 volt.



There is a further check to carry out if the temperature goes above 125°C then the display changes to yellow and an alarm message appears on the display. Above this temperature the boiler is always off, avoiding the risk of dangerously high temperatures.

ERROR:

If the temperature is not absorbed check the boiler resistor, relative wiring and the connection to the CPU/POWER in (JP19), also check the wiring on the NTC (JP13).

SteamOut

To enter Test Mode

1. Hold down the Espresso and Menu buttons
2. Switch on the main switch at the back of the machine

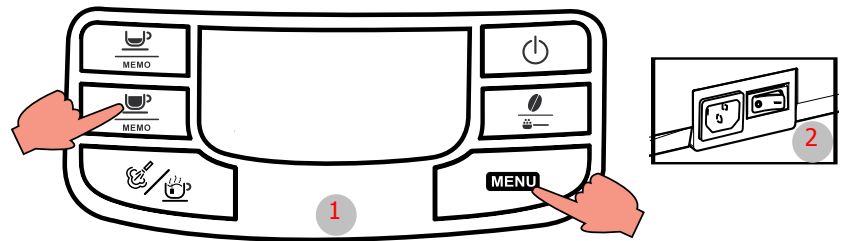

This procedure is carried out whenever you need to completely empty the residual water from the boiler.

It is recommended to carry out the SteamOut when the machine is used in places where the temperature could freeze the water inside the machine



When the machine is switched on the procedure starts; the display changes to yellow and the word "ON" indicates that the procedure is running. During the procedure the 2-way solenoid valve remains open and the steam is discharged.

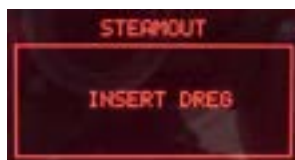

Caution!!!

If the dreg drawer is not fully in, the machine will ask you to insert it, this must be done otherwise the 2- and 3-way solenoid valves are not powered.

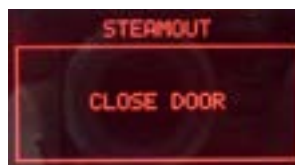

Caution!!!

If the side hatch opens, the machine warns you to close it, the hatch must be closed otherwise the 2- and 3-way solenoid valves will not be powered.



When the procedure is completed, the message "COMPLETE" appears on the display, the solenoid valves close automatically and the machine may be switched off.

5.1.3. Test Mode Intelia latte

To enter Test Mode

- A) Hold down the Espresso and Milk buttons.
- B) Switch on the main switch at the back of the machine.

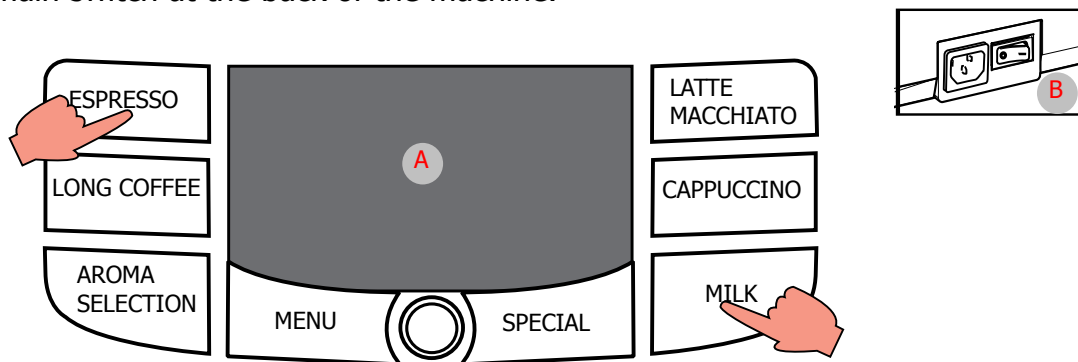

Firmware Software version



Shows the version of the firmware loaded.

Press STAND_BY "  " to move to the next screen

Operational check – keys



Initial status



The letter next to it changes from N to Y only when a button is pressed.

By pressing buttons 1, the display color changes from GREEN to RED.

By pressing buttons 2, the display color changes from GREEN to YELLOW.

By pressing buttons 3,4,5,6,7,8,9, the display color is GREEN.

Button 4 must be pressed at the end only once as when pressed it moves to the next page.



ERROR condition:

The letters do not change from N to Y or are always Y, in this case check the flat communication cable with the power board -Power JP21, if it does not change color check the cable JP4 between the board and the display.

Press STAND_BY "  " to move to the next screen

Operational check - microswitches and sensors

| INPUTS | | | |
|------------|-------|-------|---|
| TANK-H2O=N | DOOR= | N | |
| DREG= | N | BU-P= | N |
| COM= | USCP | TRAY= | N |

Initial status

| INPUTS | | | |
|-----------|------|-------|---|
| TANK-H2O= | Y | DOOR= | N |
| DREG= | N | BU-P= | N |
| COM= | USCP | TRAY= | N |

If you insert a full drip tray the TANK-H2O indicator must change from "N" to "Y".

ERROR condition:

If the indication does not change, check the capacitive sensor and relative wiring (JP23).

| INPUTS | | | |
|------------|-------|-------|---|
| TANK-H2O=N | DOOR= | N | |
| DREG= | Y | BU-P= | N |
| COM= | USCP | TRAY= | N |

Insert grounds drawer

The DREG indicator must change from "N" to "Y"

ERROR condition:

If the indication does not change, check the microswitch on the dreg drawer and relative wiring (JP16).

| INPUTS | | | |
|------------|-------|-------|---|
| TANK-H2O=Y | DOOR= | N | |
| DREG= | Y | BU-P= | N |
| COM= | USCP | TRAY= | N |

Close the side hatch (the dreg drawer must be inserted)

The DOOR indicator must change from "N" to "Y"

ERROR condition:

If the indication does not change, check the Microswitch on the hatch and relative wiring (JP14), make sure that the dreg drawer is correctly in position.

| INPUTS | | | |
|------------|-------|-------|---|
| TANK-H2O=Y | DOOR= | Y | |
| DREG= | Y | BU-P= | N |
| COM= | USCP | TRAY= | N |

Insert the brewing unit

The BU-P indicator must change from "N" to "Y"

(this step takes 2-3 sec)

ERROR condition:

If the indication does not change, check the brewing unit microswitch and relative wiring (JP16)

| INPUTS | | | |
|------------|-------|-------|---|
| TANK-H2O=Y | DOOR= | Y | |
| DREG= | Y | BU-P= | Y |
| COM= | USCP | TRAY= | N |

Insert the brewing unit

The TRAY indicator must change from "N" to "Y"

ERROR condition:

If the indication does not change, check the brewing unit microswitch and relative wiring (JP04)

| INPUTS | | | |
|------------|-------|-------|---|
| TANK-H2O=Y | DOOR= | Y | |
| DREG= | Y | BU-P= | Y |
| COM= | USCP | TRAY= | N |

Press STAND_BY "  " to move to the next screen

Operational check - impuls Milk

| INPUTS MILK | | | |
|-------------|---|------|---|
| CARAFE= | N | TAP= | N |

NOT USED

Operational check – brewing unit



Initial status

IMPORTANT: This check can only be carried out with the dreg drawer in and the side hatch closed



Press the espresso button to move the brewing unit to the "WORK" position

When the unit is in position, the WORK indication changes from "N" to "Y", the absorption current must be less than 200mA without the brewing unit on, and less than 300mA with the brewing unit on.

ERROR condition:

The WORK indicator always stays on "N"

ERROR:

The WORK indicator changes, and remains permanently on "N", while the display changes from green to red; check the microswitch, the motor of the gear motor (this may be blocked) and the wiring JP16.



ERROR (without brewing unit):

If the absorbed current exceeds 200 mA the display turns red, check the gears on the gear motor and the motor housing in its seat.



ERROR (with brewing unit):

If the absorbed current exceeds 300 mA the display turns red, check the brewing unit, the gears on the gear motor and the motor housing in its seat.



Press the coffee button to move the brewing unit to the "HOME" position

When the unit reaches the HOME position the indicator changes from "N" to "Y", the absorbed current, without the brewing unit, must be less than 200, and with the brewing unit less than 300 mA

ERROR condition:

The HOME indicator always stays on "N"

ERROR:

The HOME indicator changes, and remains permanently on "N", while the display changes from green to red; check the microswitch, unit motor (this may be blocked) and the wiring JP16.



ERROR (without brewing unit):

If the absorbed current exceeds 200 mA the display turns red, check the gears on the gear motor and the motor housing in its seat.



ERROR (with brewing unit):

If the absorbed current exceeds 300 mA the display turns red, check the brewing unit, the gears on the gear motor and the motor housing in its seat.

Press STAND_BY "  " to move to the next screen

Operational check - solenoid valve and pump

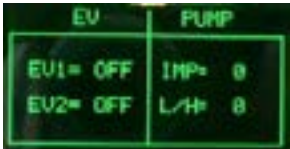

Initial status



If the dreg drawer is in position and the side hatch closed, the EV cannot be done. If it is not in the right position, a warning message is shown on the display, which turns yellow.



Press the espresso button to activate the solenoid valve

The indication next to EV1 changes from "OFF" to "ON". You can hear the "click" of the solenoid valve.



Press the coffee button to activate the solenoid valve

The indication next to EV2 changes from "OFF" to "ON". You can hear the "click" of the solenoid valve.

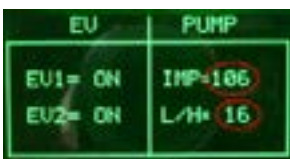

Press the aroma button to activate the pump

The water is dispensed from the steam pipe IMP indicates an increasing number of pulses. L/H must be between 10 and 18.



ERROR: The back-lit green display changes to red and the pulse remains 0 even if water comes out of the steam pipe, check the wiring on the flow meter (JP5). If water does not come out of the steam pipe, check the pump and the pump wiring (JP24).

New version with a solenoid valve



Press the ESPRESSO button to activate solenoid valve EV1.

The solenoid valve is activated and the indication to the right of EV1 changes from "OFF" to "ON".



ERROR:

The pulses remain at 0, the display turns red, this means there is an error in the water circuit. If water is coming out of the coupling, it means there is an error in the flow meter or in its wiring in the Control Board/Power Board (JP5). If no water is coming out, check the pump, the connected water circuit, or the pump wiring (JP24).

Press STAND_BY "  " to move to the next screen

Operational check - coffee grinder and boiler



Initial Status



Press the aroma button to activate the coffee grinder

The coffee grinder starts to spin and the number of pulses is indicated by the number circled in red, the other numbers have no significance for this test.



ERROR:

If the number remains 0, the display changes to red, and the motor runs, the problem lies in the Hall sensors, or their wiring, or in the CPU/POWER input (JP2). If the motor does not run, the problem may lie in the chain (JP8), the coffee grinder wiring or the actual coffee grinder.

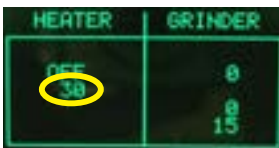

Temperature control

The circled number expresses the boiler temperature in degrees centigrade.

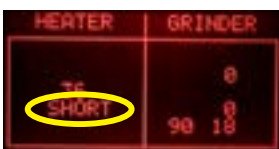

ERROR:

If the HEATER indicator shows the word "SHORT", this means that the NTC temperature sensor is in short circuit. The display changes from green to red: in this case check the wiring on the NTC or the CPU/POWER inlet (JP13).



ERROR:

If the HEATER indicator displays the word "OPEN", this means that the NTC temperature sensor is disconnected; the display changes from green to red; in this case check the continuity of the NTC wiring, and check the connection to the CPU/POWER in (JP13).



Press the coffee button to activate the boiler

The indicator changes from "OFF" to "ON" and shortly after the temperature indicator should start to increase, and the ammeter on the counter must display an absorption of approximately 8 Ampere with 230 volt.



There is a further check to carry out if the temperature goes above 125°C then the display changes to yellow and an alarm message appears on the display. Above this temperature the boiler is always off, avoiding the risk of dangerously high temperatures.

ERROR:

If the temperature is not absorbed check the boiler resistor, relative wiring and the connection to the CPU/POWER in (JP19), also check the wiring on the NTC (JP13).

5.1.4. Intuita

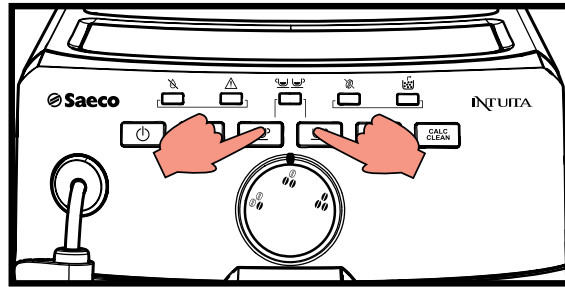

To enter Test Mode

The machine enters in test mode by pushing the ESPRESSO and COFFEE buttons and then turning ON the AC power.

As long as the buttons are pressed the machine shows LED Double Service flashing.

When the buttons are released the machine passes to the first level of the test.

There are 6 different level, in each level the coffee-machine can execute different commands

Level 0: The machine tests the LED:

- a) Turn ON every LED
- b) Turn OFF every LED
- c) Sequence turn ON every LED

Level 1: The machine tests the buttons:

- a) Button Hot Water
- b) Button Espresso
- c) Button Coffee
- d) Button Steam
- e) Button Calc Clean

Level 2: The machine tests the other input signals:

- a) Capacitive sensor in water tank
- b) Switch door close / open
- c) Switch brewing unit presence
- d) Switch dump box presence

Level 3: The machine tests the aroma trimmer:

- a) Aroma position 1 bean
- b) Aroma position 2 beans
- c) Aroma position 3 beans

Level 4: The machine tests the water circuit:

- a) EV
- b) Pump (plus flux meter)
- c) Brewing unit moves to work
- d) Brewing unit moves to home

Level 5: The machine tests the coffee powder circuit:

- a) Heater (plus NTC sensor)
- b) Grinder (plus rotation pick up)

The user can switch the level by pressing the ON/OFF button, the machine shows the level of the test:

- a) Level 1: LED No Water
- b) Level 2: LED No Water, LED Error
- c) Level 3: LED No Water, LED Error, LED Double
- d) Level 4: LED No Water, LED Error, LED Double, LED No Beans
- e) Level 5: LED No Water, LED Error, LED Double, LED No Beans, LED Dump Box

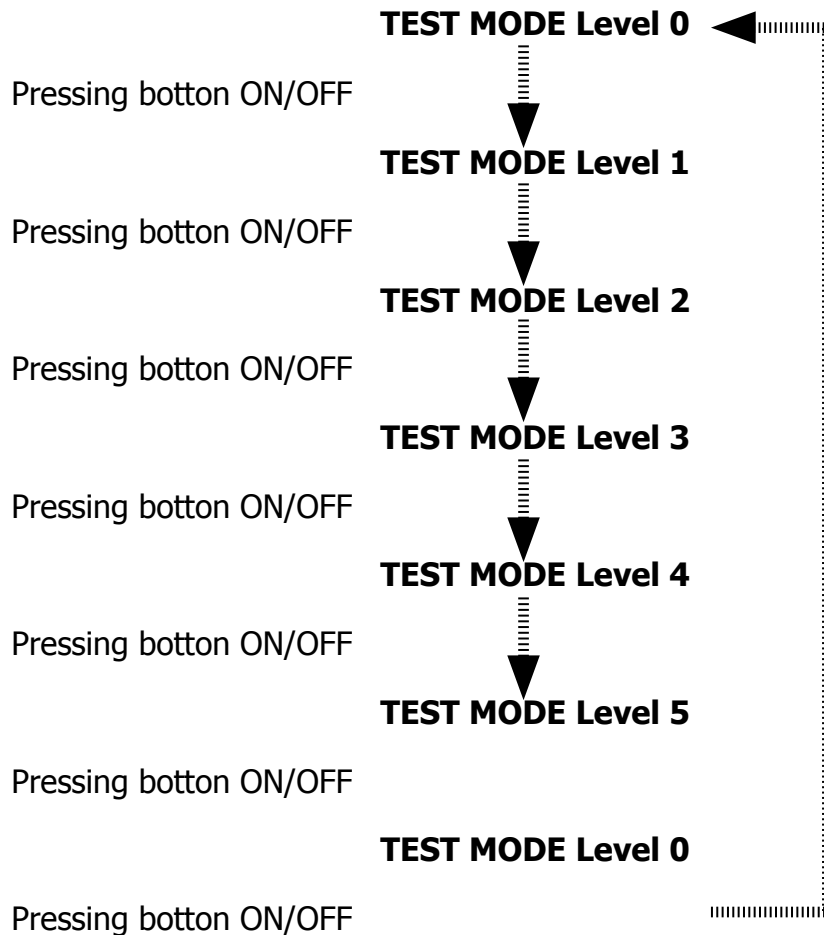

Level 0 (LED)**Description :**

Verify keyboard LED

Action :

LED ON/OFF always blink during the test.

The others LED blink once, then only one LED is ON starting from No Water, Error, Double, No Beans, Dump Box, Calc Clean, Steam, Coffee, Espresso, Hot Water.

The sequence is always repeated.

Note

| LED | COLOR |
|------------|--------|
| No Water | RED |
| Error | RED |
| Double | GREEN |
| No Beans | RED |
| Dump Box | RED |
| Calc Clean | YELLOW |
| Steam | GREEN |
| Coffee | GREEN |
| Espresso | GREEN |
| Hot Water | GREEN |
| ON/OFF | RED |

Pressing ON/OFF button moves to next level

On ERROR verify:

Cable connection

Power supply

Driver 74HC595 presence and welding

Driver 74HC595 orientation

LED presence and welding

LED orientation

Polarization resistor presence and welding

Level 1 (Buttons) [LED No Water ON]**Description:**

Verify the keyboard buttons (each button has a rear LED)

Action:

Pressing the button where the rear LED is ON changes the LED OFF, follow the moving LED

If you are not able to turn the LED OFF detects an error condition over the button switch

Start condition

All LED are OFF

Pressing ON/OFF button moves to next level

On ERROR verify:

Cable connection

Power supply

Push button presence and welding

Level 2 (switch) [LED No Water + Error ON]**Description:**

Verify the security switch connection

Action:

Mechanical move the switch and verify the relative electrical feedback

Start condition (no water tank, no BU, no dump box, door open)

All LED are blinking (because every switch is OFF)

Closing every switch turns ON the LED

| | |
|----------------|-----------|
| Switch | LED |
| Water presence | hot water |
| BU presence | espresso |
| Door open | coffee |
| Dump box | steam |

Press ON/OFF button moves to next level

On ERROR verify:

Cable connection

Power supply

Level 3 (Aroma trimmer) [LED No Water + Error + Double ON]**Description:**

Verify the aroma trimmer

Action:

Rotate aroma trimmer, 3 position 3 LED

Start condition none

| | |
|---------|-------------------------------|
| Aroma | LED |
| 1 bean | hot water |
| 2 beans | hot water + espresso |
| 3 beans | hot water + espresso + coffee |

Press ON/OFF button moves to next level

On ERROR verify:

Cable connection

Power supply

Level 4 (Water Circuit) [LED No Water + Error + Double + No Beans ON]**Description:**

Verify the water circuit component: flux meter, pump, electro valve, brewing unit

Action:

Turn on and off actuators along water and coffee beverage circuit.

Start condition (water tank full, BU, dump box, door closed)

| LED | ON/OFF | Hot water | Espresso | Coffee | Steam | Calc clean |
|-----|--------|-----------|----------|--------|-------|------------|
| OK | OFF | OFF | OFF | OFF | OFF | OFF |

Press one time Hot Water button to open electro valve

| LED | ON/OFF | Hot water | Espresso | Coffee | Steam | Calc clean |
|-----|--------|-----------|----------|--------|-------|------------|
| OK | | ON | | | | |

Press Espresso button to turn on pump

| LED | ON/OFF | Hot water | Espresso | Coffee | Steam | Calc clean |
|--------------------------------|--------|-----------|----------|--------|-------|------------|
| During the test | | | BLINK | | | OFF |
| OK | | | ON | | | OFF |
| ERROR (no flux meter feedback) | | | ON | | | ON |

Press one time Hot Water button to close electro valve

| LED | ON/OFF | Hot water | Espresso | Coffee | Steam | Calc clean |
|-----|--------|-----------|----------|--------|-------|------------|
| OK | | OFF | | | | |

Move BU to work position. Press Coffee button to move BU to work position

| LED | ON/OFF | Hot water | Espresso | Coffee | Steam | Calc clean |
|----------------------------------|--------|-----------|----------|--------|-------|------------|
| During the test | | | | BLINK | | OFF |
| OK | | | | ON | | OFF |
| Work position not reached | | | | ON | | ON |
| Overcurrent (with or without BU) | | | | ON | | BLINK |

Move BU to home position. Press Steam button to move BU to home position

| LED | ON/OFF | Hot water | Espresso | Coffee | Steam | Calc clean |
|----------------------------------|--------|-----------|----------|--------|-------|------------|
| During test | | | | | BLINK | OFF |
| OK | | | | | ON | OFF |
| Home position not reached | | | | | ON | ON |
| Overcurrent (with or without BU) | | | | | ON | BLINK |

Move BU to rest position. Press Calc Clean button to move BU to rest position

| LED | ON/OFF | Hot water | Espresso | Coffee | Steam | Calc clean |
|-----|--------|-----------|----------|--------|-------|------------|
| OK | | | | BLINK | BLINK | |

Press ON/OFF button moves to next level

On ERROR verify:

Cable connection

Power supply

Level 5 (Grinder & Heater)**[LED No Water + Error + Double + No Beans + Dump Box ON]****Description:**

Verify temperature increase in the heater and grinder rotation

Action:

Turn on and off actuators

Start condition (water tank full, BU, dump box, door close)

| LED | ON/OFF | Hot water | Espresso | Coffee | Steam | Calc clean |
|-----|--------|-----------|----------|--------|-------|------------|
| OK | OFF | OFF | OFF | OFF | OFF | OFF |

Press once Hot Water button to check heater NTC sensor

| LED | ON/OFF | Hot water | Espresso | Coffee | Steam | Calc clean |
|---------------------------------|--------|-----------|----------|--------|-------|------------|
| During the test | | BLINK | | | | OFF |
| OK | | ON | | | | OFF |
| ERROR NTC open or short circuit | | ON | | | | ON |

Press Espresso button to check heater power on (you need current sense / measure)

| LED | ON/OFF | Hot water | Espresso | Coffee | Steam | Calc clean |
|---------------------------|--------|-----------|----------|--------|-------|------------|
| OK CURRENT SENSE > 1 A | | | ON | | | OFF |
| Heater already hot | | | | | | BLINK |
| ERROR CURRENT SENSE > 1 A | | | ON | | | OFF |

Press Coffee button to check grinder rotation

| LED | ON/OFF | Hot water | Espresso | Coffee | Steam | Calc clean |
|---------------------|--------|-----------|----------|--------|-------|------------|
| During the test | | | | BLINK | | OFF |
| OK | | | | ON | | OFF |
| No grinder rotation | | | | ON | | ON |

Press ON/OFF button moves to next level (level 0)

On ERROR verify:

Cable connection

Power supply

5.2. Error codes

| ERROR CODES | DESCRIPTION |
|--------------------|---|
| 01 | The coffee grinder is blocked (grinder blades jammed or sensor not reading properly) |
| 03 | The brewing unit is blocked in work position (microswitch not released in up position after 3", torque error trying to move down, descent time out exceeded) |
| 04 | The brewing unit is blocked in home position (microswitch not released in down position after 3", torque error trying to move up, ascent time out exceeded) |
| 05 | Water circuit / flow meter problems (water circuit blocked or no flow meter signal) |
| 10 | Boiler temperature sensor short circuited |
| 11 | Boiler temperature sensor open circuit |
| 14 | The boiler temperature has exceeded the maximum allowed value (165°C) |
| 15 | The boiler temperature has not increased by x°C in y sec (boiler power supply disconnected, incorrect boiler fitted must be a 1300W boiler, partial power supply to boiler, cut out thermostat tripped) |
| 19 | Mains voltage trouble |



CHAPTER 6

SERVICING AND MAINTENANCE

6.1. Repair flow

| Proces stap | Saeco no. | Action |
|---------------------------|--|---|
| Intake | 1 | Visual inspection (transport damage) take care for pictures |
| | 2 | Check Type/serialnumber |
| | | Log all available accessory |
| Diagnosis | 3 | Check product for consumer complaint (NFF contact consumer) |
| | 4 | Opening machine |
| | 5 | Visual inspection check for loosen parts, leaking etc.. |
| | 6 | Operational tests |
| Repair | | Run Diagnostic to get error codes and relevant set statistics (Saeco Service Center SSC) |
| | 7 | Repairing the faults encountered |
| | 8 | "Checking any modifications (view Symptom Cure, new software, etc.) Refer Annex tabs per family" |
| | 9 | Service activities in accordance with the operating schedule |
| | | Check/Replace Waterfilter (the small filter, not the Britta filter) |
| | | Check/Replace Water tank lip seal |
| | | Check/Replace Boiler pin O-ring |
| | | Clean/align Coffee grinder (Vacuum cleaner / brush) |
| | | Descale the water Circuit |
| | | Check/Replace Hot water/steam valve |
| | 10 | Internal check / cleaning |
| | | Check/Clean/Grease Brewing unit |
| | 11 | Operational test while the appliance is open |
| | | Check Hoses, attachments and Oetiker clamps |
| | Check Pump for operation & noise | |
| | Check Gear motor for operation & noise | |
| | Check for leakage | |
| 12 | Assembly | |
| 13 | Final inspection test | |
| 14 | Steam out before shipping out, if temperature is below 0° to prevent any damaged due to frozen water | |
| Inspection | | |
| visual | | Do cabinet parts fit well together |
| | | Check for damages |
| Power check | | Will the set switch on |
| Accessoires | | Do the accessories match with the intake |
| Consumer complaint | | Check the product for the consumer complaint |
| Coffee | | |
| Dispense | | Make 2 * coffee. Are both amounts equal |
| | | Make e 2 cups at the same time. Are the volumes equal |

| | | |
|---------------|----|---|
| Noise | | Is the sound normal |
| Crema | | Blow on the coffee. Does the crema come back together |
| | | Is the crema colour correct (Hazelnut) |
| Temperature | | Is the coffee temperature within spec |
| Grinder | | Is the grinder noise normal |
| Steam | | |
| Steam | | Does the steam work |
| Hot Water | | Does the hot water work |
| Milk | | (if applicable) |
| Cappuchino | | Does the cappuccinatore produce good froth |
| Leakage | | |
| Leakage | 14 | Did the product leak during the testing |
| | 15 | Draining the circuit (in winter) |
| Cleaning | | Clean water reservoir, bean reservoir, brew chamber and conveyor |
| | 16 | Clean and dry brew unit, coffee bin and drip tray. |
| | | Lubricating the brewing unit with suitable grease |
| | | External cleaning |
| Safety check | | |
| | | Earth leakage, Isolation test, resistor of earth wire grounding, as requested in certain country's (VDE, ISO) |
| visueel | | Check the mains cord for damages |
| Packing | | |
| | 18 | Packing |
| | | Check completeness (accessories) according income log |
| | 19 | Neatly pack the product |
| Documentation | | NFF letter |
| | | Descaling instruction with changed procedure (S/C) |
| | | Other instructions according S/C |
| Repair report | | Is there an answer to ALL consumer questions/complaints (see complaint) |
| | | add set statistic and give, if needed clear instruction towards consumer |
| | | Is it indicated which documents are added |
| | | Are there tips how to prevent issues |



CHAPTER 7

DISASSEMBLY

7.1. Intelia Cappuccino outer Shell

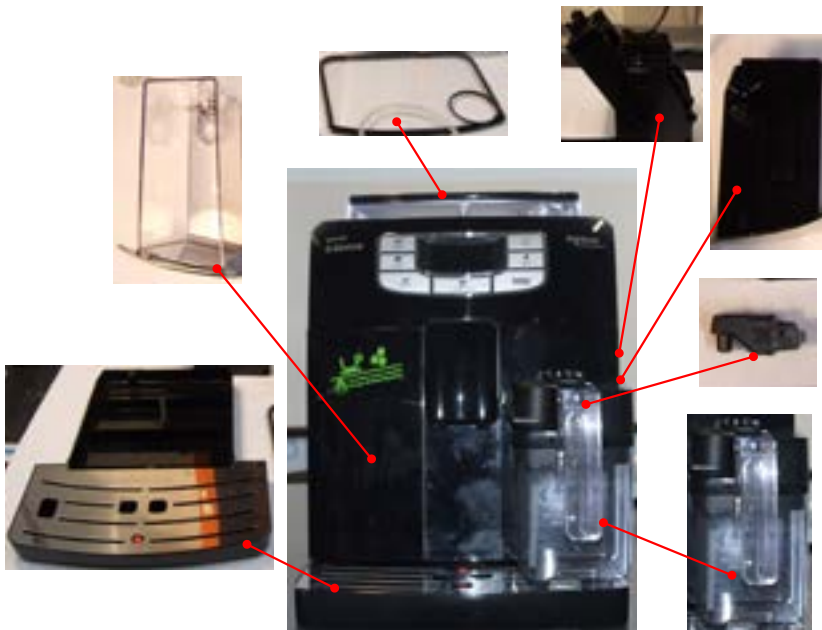

Remove the water tank, coffee container cover, drip tray, dreg drawer, brewing unit, carafe or hot water dispenser.



Unscrew the screws shown and remove the finger protection.

Lift the top cover.

Unscrew the screws shown and slide out the left side body.

Slide out the hatch.



Loosen the screws as illustrated, slide out the rear body and the sound insulating cover of the coffee grinder.

7.2. Intellia Class and Focus outer Shell

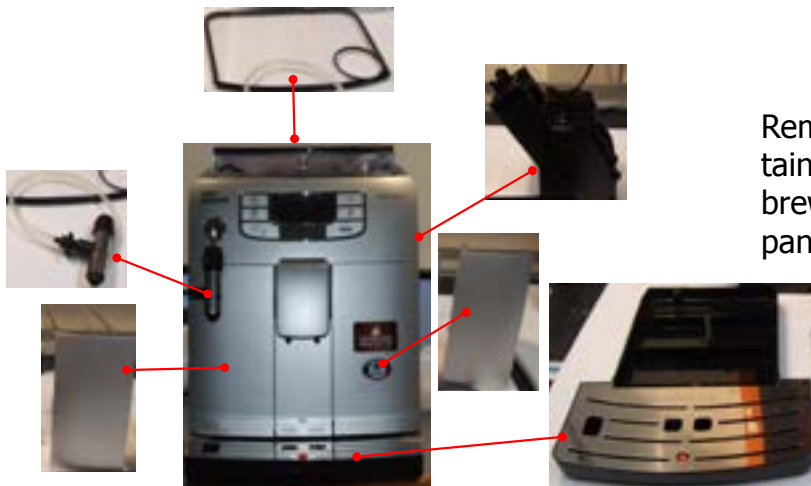

Remove the water tank, coffee container cover, drip tray, dreg drawer, brewing unit, cappuccino maker or pannarello.

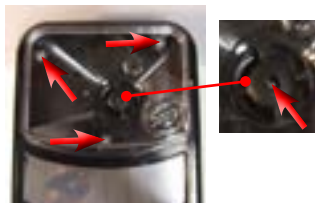

Unscrew the marked screws and remove the finger protection.



Raise the top cover.



Loosen the screws as illustrated and remove the left side body.

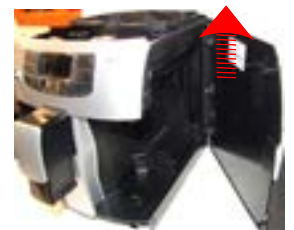

Slide out the hatch.

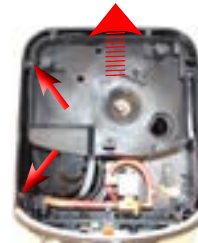
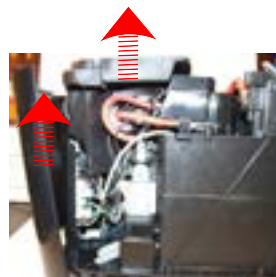

Loosen the screws as illustrated, slide out the rear body and the sound insulating cover of the coffee grinder.

7.3. Coffee grinder

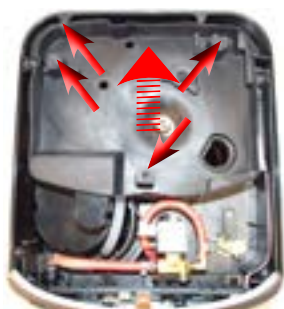

Loosen the screws as illustrated and remove the sound insulating cover. Raise the coffee grinder and remove the connections.



When reassembling the coffee grinder, make sure the spring is repositioned correctly (see photo).

7.4. Grinder blades

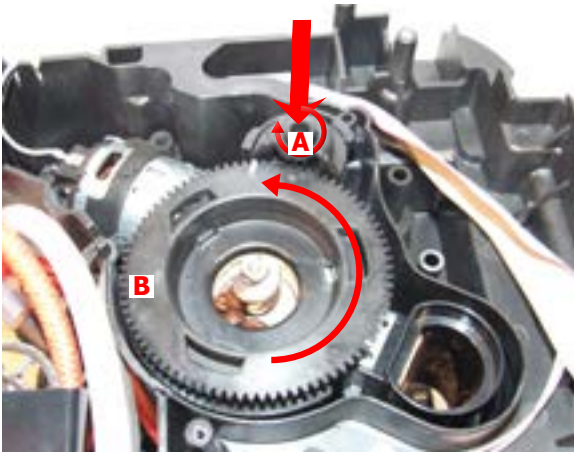

To extract the top support of the appliance, press on the grinding adjustment spindle (A) and turn the support anticlockwise until it unhooks.



Turn the grinder blades anticlockwise out of the support.

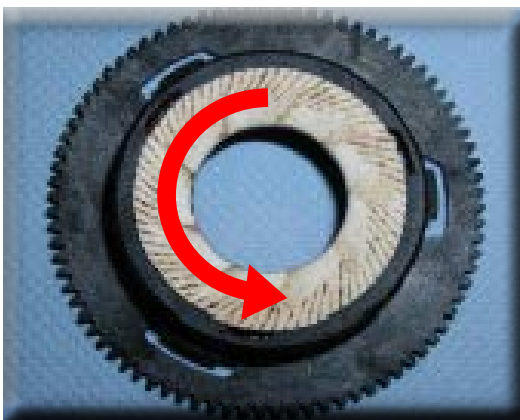

Turn the grinder blades clockwise out of the support. The bayonet connections can be accessed from the rear.

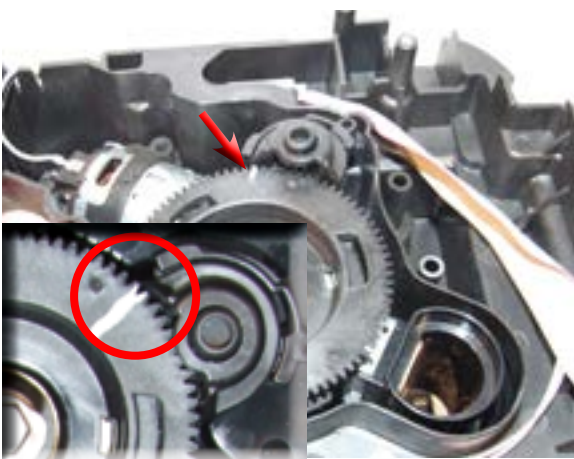

For a standard adjustment, both markings must be aligned.

7.5. Coffee grinder adjustment

The grinding adjustment can be set by the user (only with the coffee grinder in operation) by pressing and turning (only by one click at a time) the insert inside the coffee bean hopper with the aid of the wrench supplied.



Adjustment by a service center

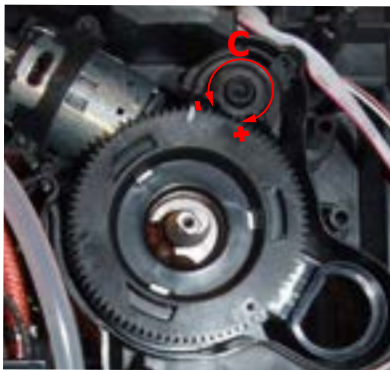

To adjust grinding further, the engineer can work directly on the coffee grinder by pressing and turning the ring nut (C) shown. (clockwise + to increase the particle size of the coffee and anticlockwise - to decrease it).

If there are any remains of coffee powder between the two grinding blades it is recommended to tighten by max. two marks at a time.

Lastly, move the arrow (A) on the adjustment knob to the center of the adjustment dots on the cover (B).

7.6. Intelia Cappuccino three-way solenoid valve

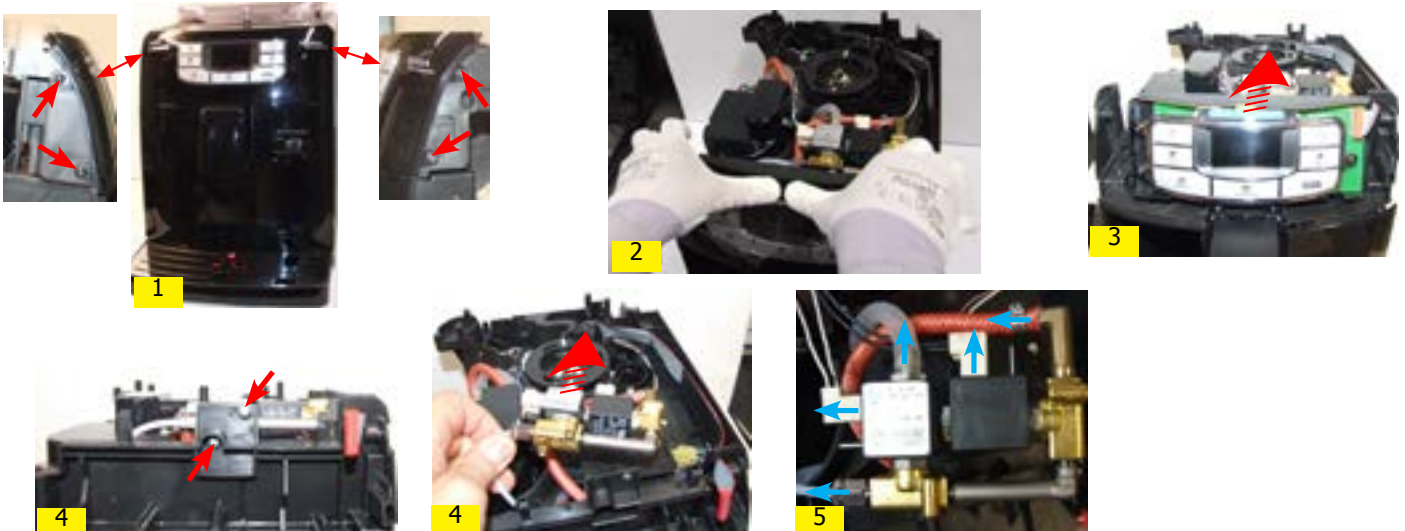

- 1) Loosen the screws highlighted
- 2) Remove the front plate, pressing it in the center and pulling the side walls outward
- 3) Remove the board support assembly
- 4) Loosen the screws holding the solenoid valve to the upper plate
- 5) Disconnect all electrical and water circuit connections

7.7. Intelia Class and Focus two-way solenoid valve

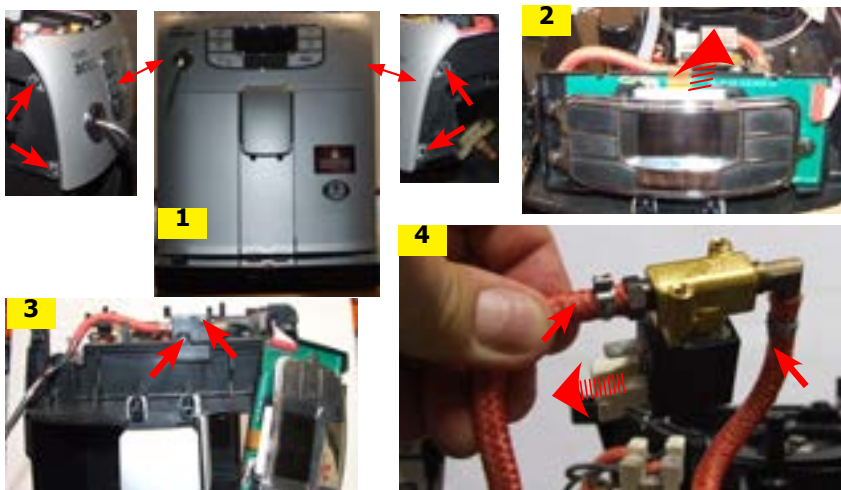

- 1) Loosen the screws highlighted.
- 2) Remove the card support assembly.
- 3) Loosen the screws holding the solenoid valve to the upper plate.
- 4) Disconnect all electrical and water circuit connections.

7.8. Two-way solenoid valve (V2)



Loosen the screws highlighted and the remove the front cover panel.

Remove the lid of the dispenser with the aid of a screwdriver



Loosen the screws as illustrated and release the insert in the bottom of the body to obtain easy access for valve disassembly

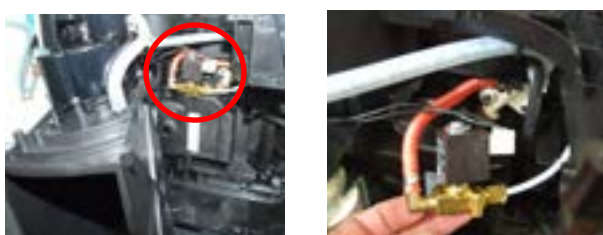

Disconnect all electrical and water circuit connections.

7.9. Intelia Cappuccino carafe fitting body

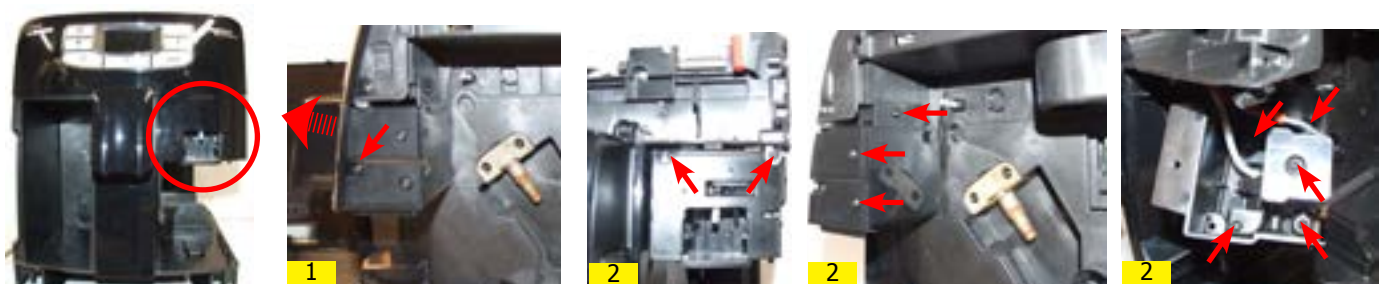



- 1) Loosen the screws holding the front cover of the carafe fitting body and release it from its seat
- 2) Loosen the screws as illustrated
- 3) Remove carafe presence sensors
- 4) Remove carafe fitting Teflon pipe

7.10. Pump

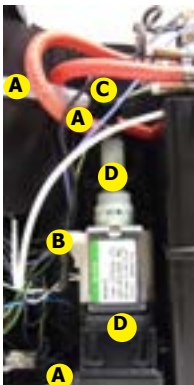

Disconnect the water circuit connections (A) and electrical connections (B), loosen the safety valve (C) and slide the pump off the brackets (D).

7.11. Flow-meter



Lift the flow meter out of the casing assembly and remove the electrical and water circuit connections.

7.12. Control board



Loosen the screws as illustrated, slide out the electrical connection and remove the card guard.



Slide the card off the support and disconnect the electrical connections.

7.13. Water sensor control board



Slide the card off the support.



Slide out the pipe connecting the flow meter to the pump.



Loosen the screw as illustrated and remove the capacitive sensor glued to the seat.

7.14. Gear motor

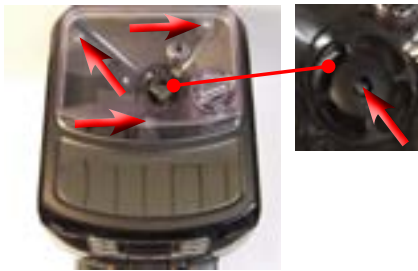

Unscrew the screws shown and remove the finger protection.



Lift the top cover.



Unscrew the screws shown and slide out the left side body.



Unscrew the screws as illustrated and remove the front panel to access the screws which fix the dispenser cover into place.



Slide out the fork as illustrated.

Only for Intelia Cappuccino remove the plug body along with pitcher

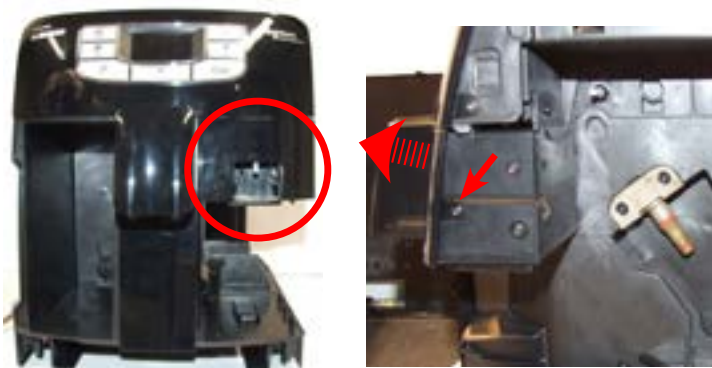

Unscrew the screws in the front cover and lift it off the milk jug plug body from the place

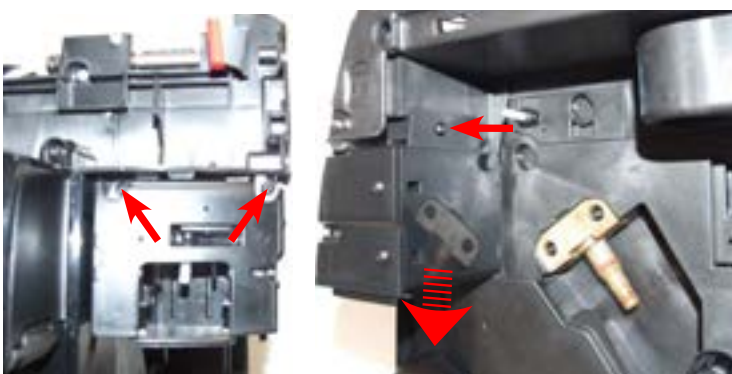

Unscrew the screws (highlighted) and release the milk jug plug body assembly

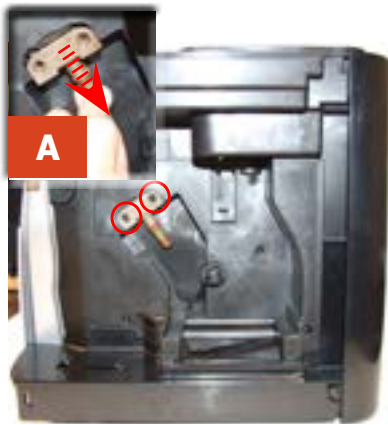

Loosen the screws as illustrated and remove the boiler pin (A).



Loosen the screws as illustrated and remove the gear motor cover.

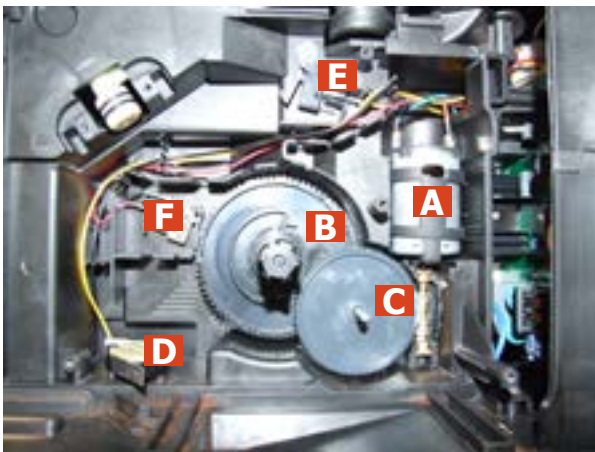

The following are located inside the compartment protected by the casing:

- Electric motor (A) with gears (B) and (C) for transmission and timing of the dispenser.
- Dreg drawer presence sensor (D).
- Brewing unit present microswitch (E).
- Microswitch (F) detecting brewing unit home and work positions.
- Remove the gear (C) that meshes with the motor transmission shaft.
- Remove the large gear (B).
- Remove the motor (A), complete with transmission shaft.

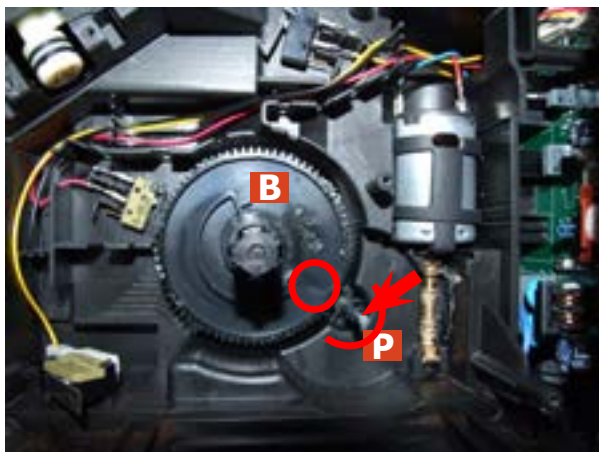

Replace the gear (B), making sure that the imprint of the arrow is aligned with the opening containing the pin (P).

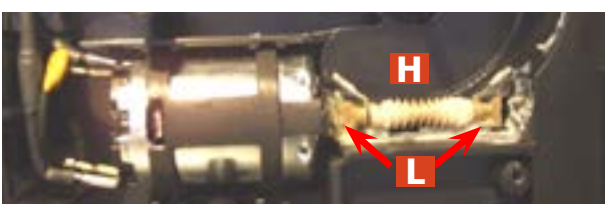

When replacing the motor and the transmission shaft, make sure the guide runners (L) are in the right position.

Grease the shaft thoroughly and evenly.

7.15. Boiler

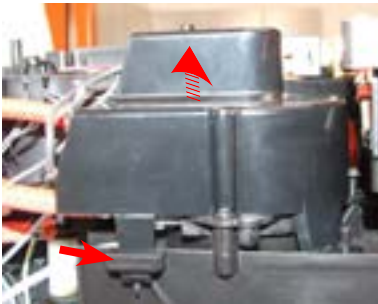

Release the boiler cover and take it off.



Unscrew the marked screw and disconnect the electrical and water circuit connections.



7.16. Dispenser assembly



Loosen the screws as illustrated and remove the front panel to access the screws which fix the dispenser cover into place.

Slide out the fork as illustrated.

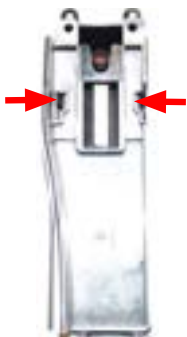

Press the hooks as illustrated and slide out the dispenser assembly.

7.17. Valve disassembly

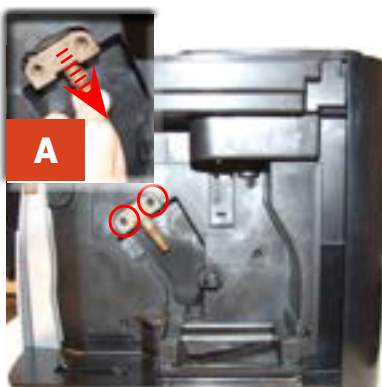

Loosen the screws as illustrated and remove the boiler pin (A)



Loosen the screws as illustrated and remove the front panel to access the screws which fix the dispenser cover into place

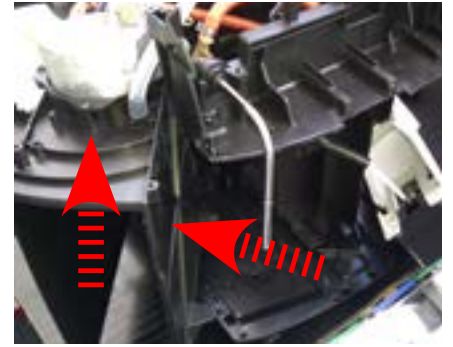

Loosen the screws as illustrated and release the insert in the bottom of the body to obtain easy access for valve disassembly

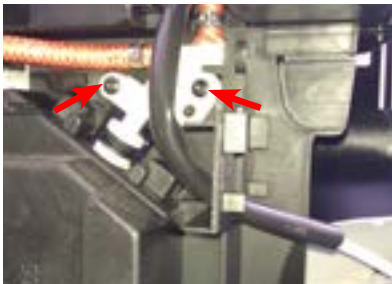

Loosen the screws as illustrated, remove the hydraulic connections and take out the valve

7.18. Control board and display



Loosen the screws as illustrated and remove the front panel.



Disconnect the electrical connections and unhook the card support.



Loosen the screws as illustrated.



Remove the frame from the keypad and the display.



Loosen the screws as illustrated.

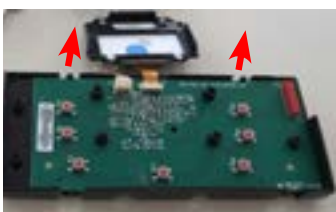

Remove the electrical connections between the card and the display and release the card from the support.

7.19. Fitting and removing Oetiker clamps

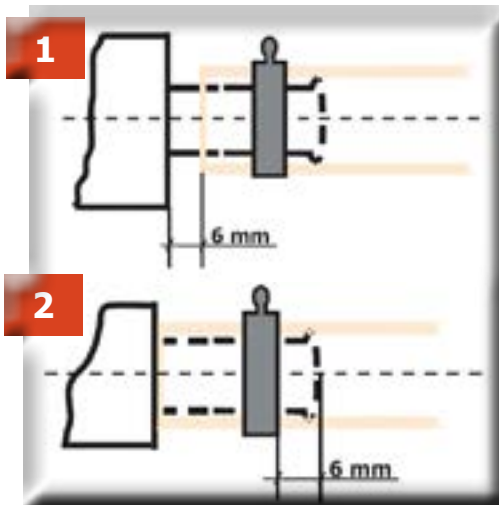

1) Boiler connection.

2) Other connections.



Use a suitable pair of pliers to remove the clamp (as illustrated).



Tighten the clamp as illustrated.



CHAPTER 8

NOTES



CHAPTER 9

WATER CIRCUIT DIAGRAM

Intelia Cappuccino

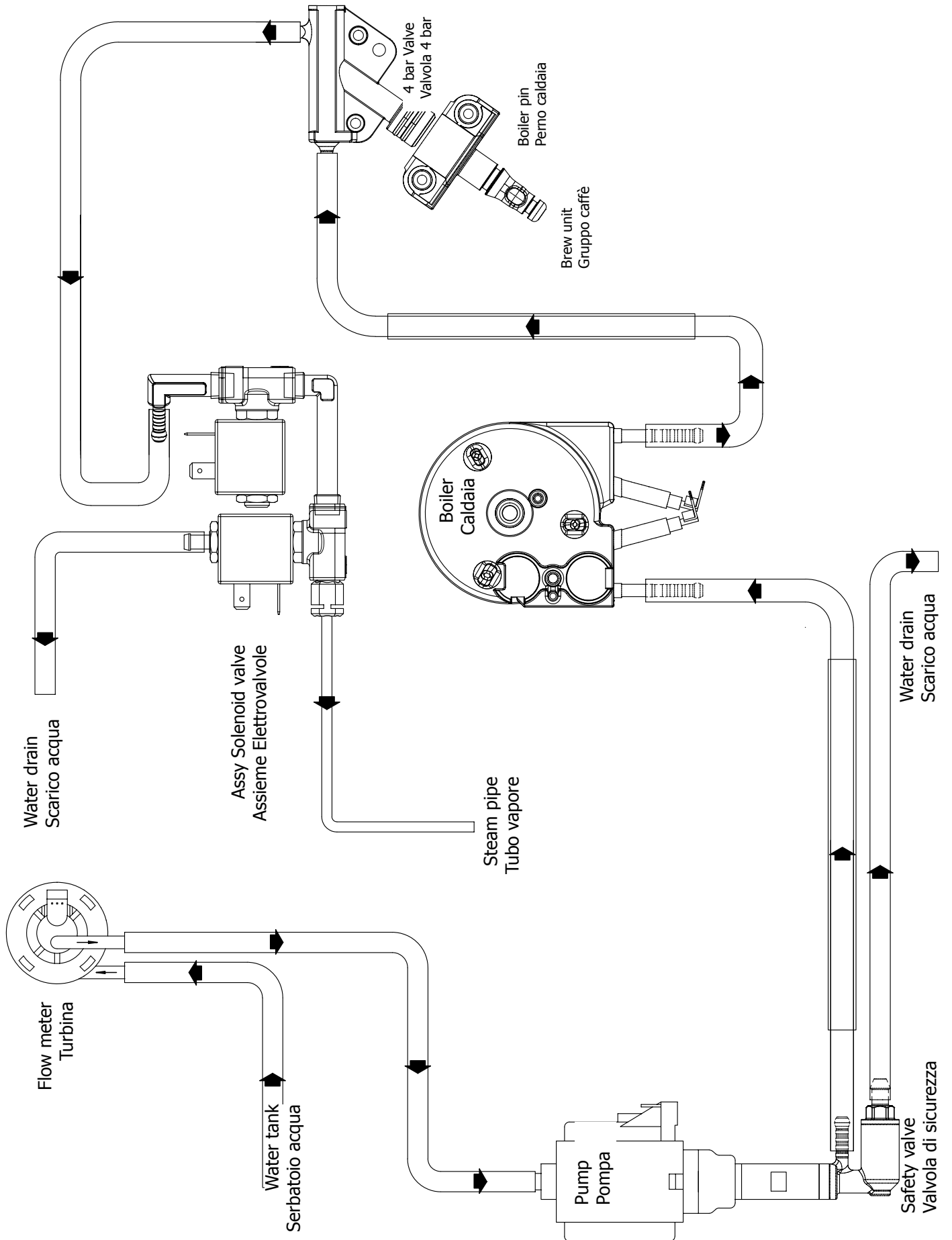

Intelia Focus - Class - Latte and Intuita

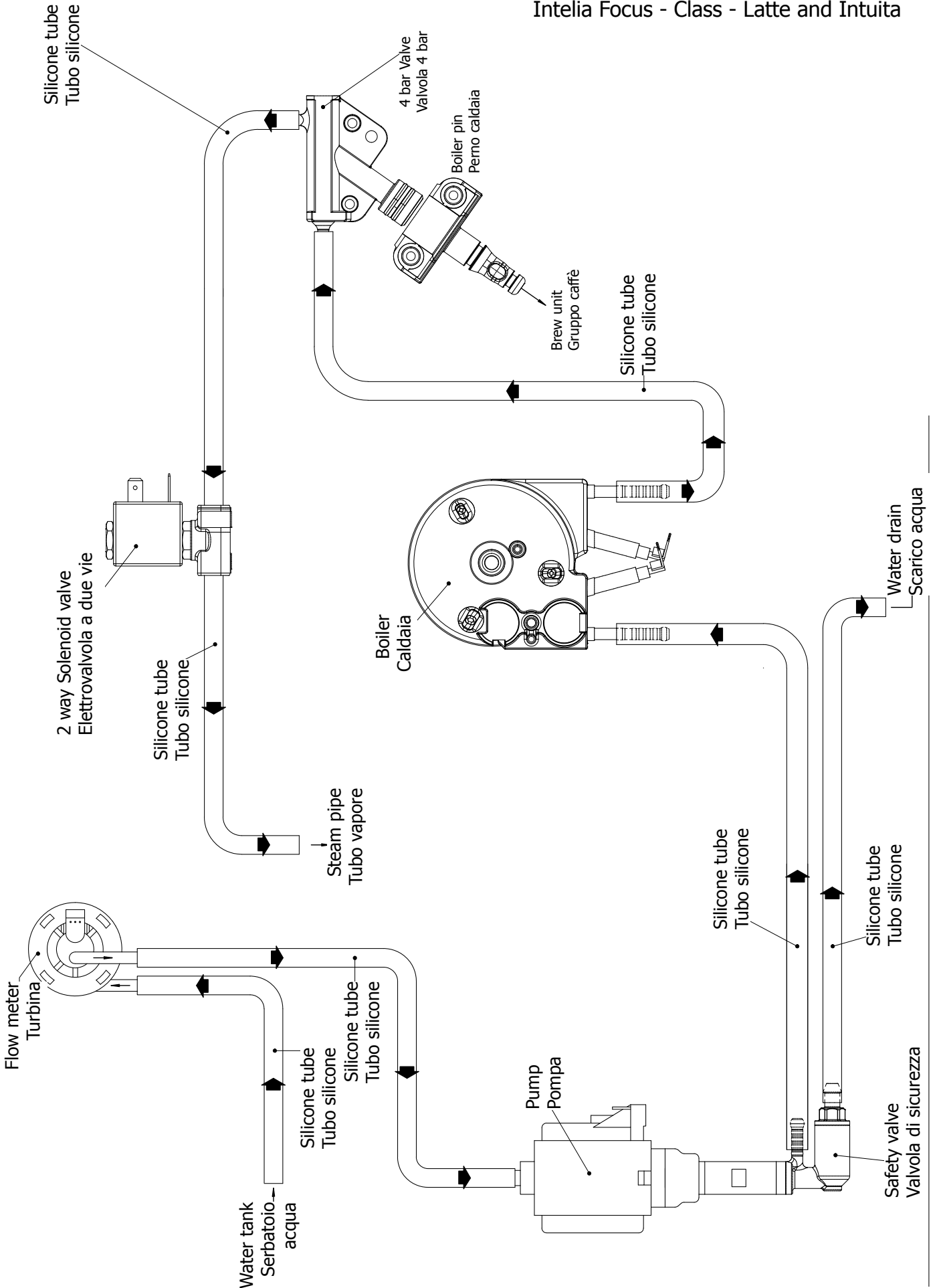



CHAPTER 10

ELECTRICAL DIAGRAM

Intelia Focus - Class - Latte and intuita

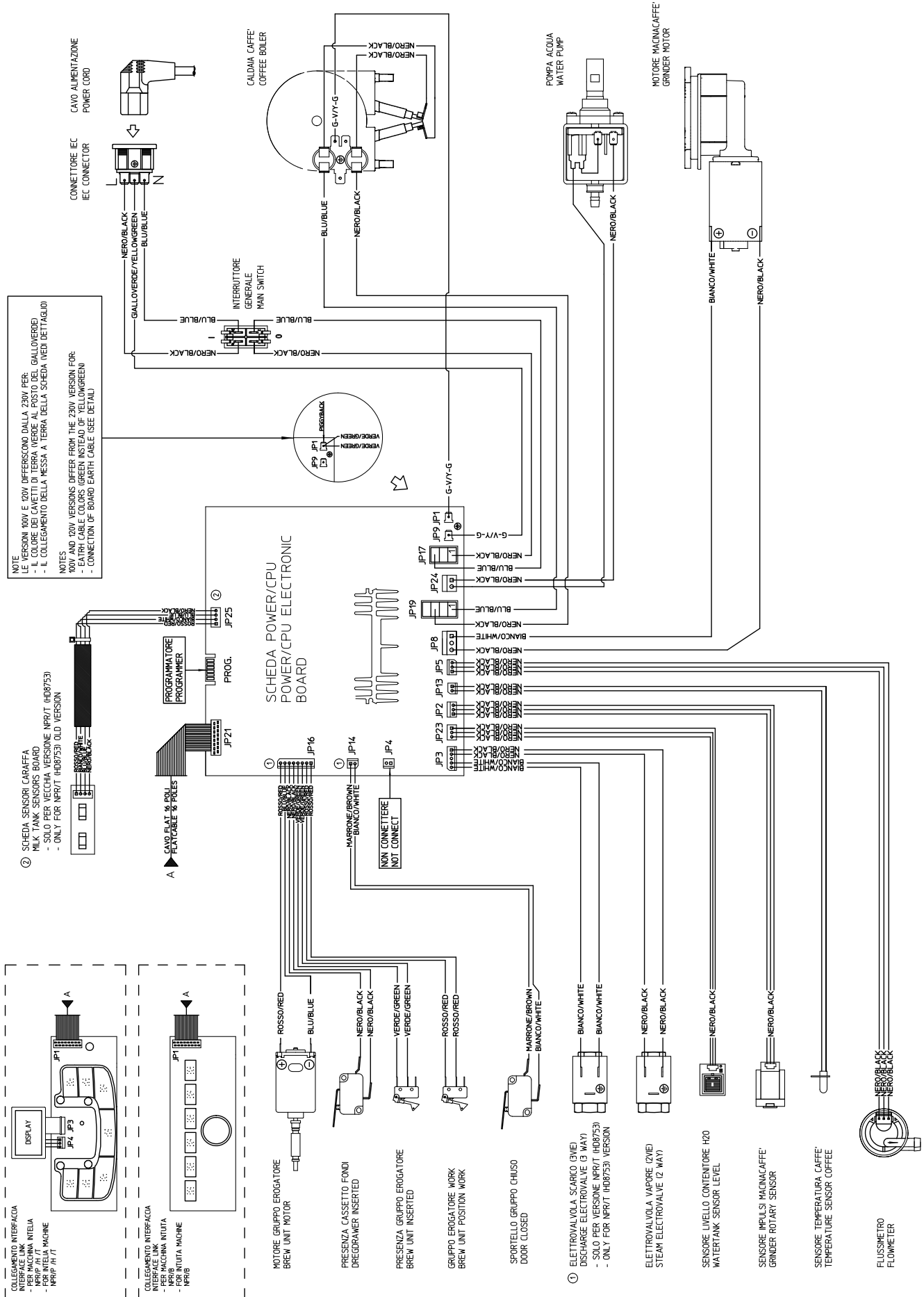

Intelial Focus - Class - Latte and intuita V2

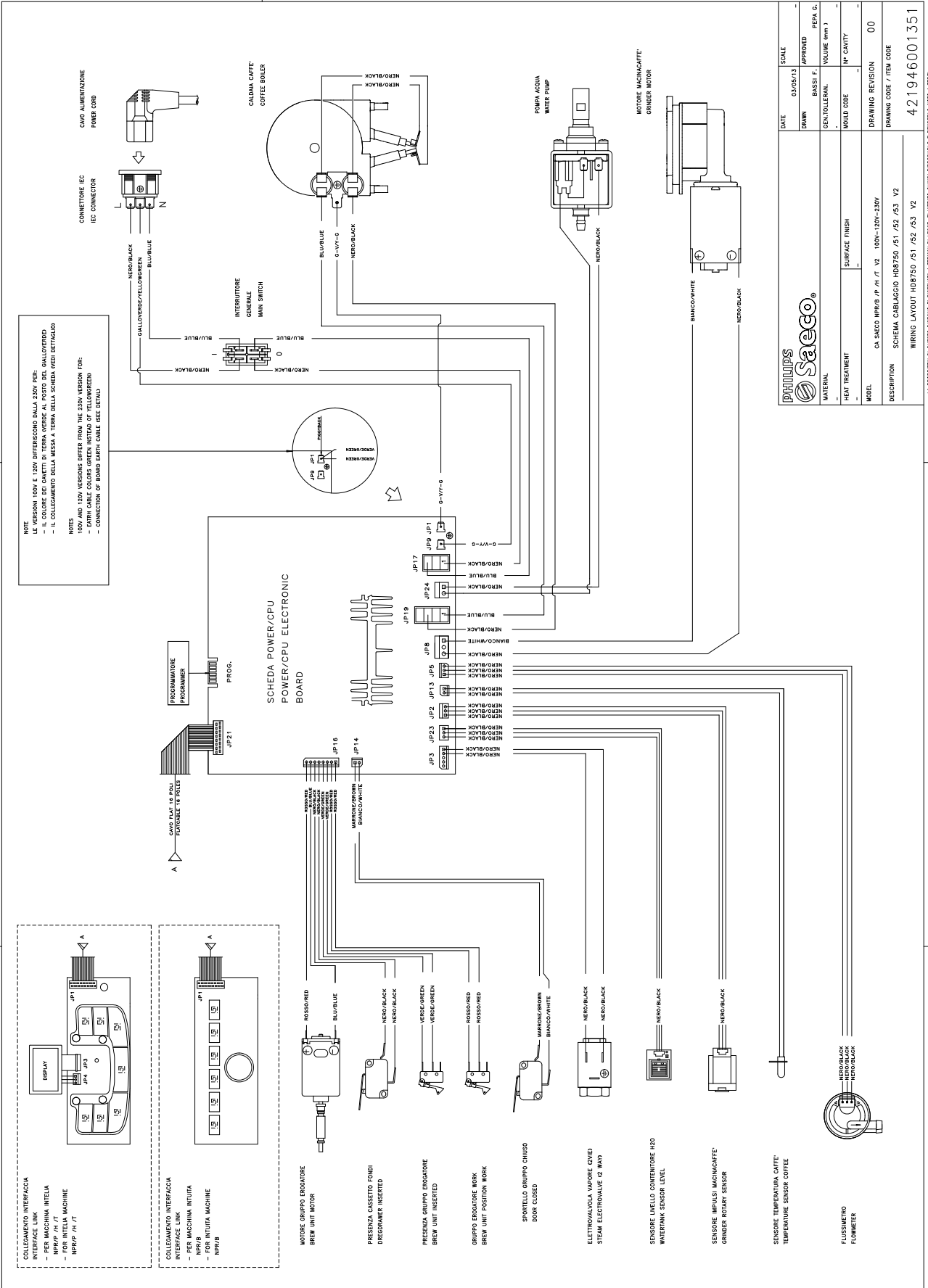

NOTE
 LE VERSIONI 100V E 120V DIFFERISCONO DALLA 230V PER:
 - IL COLLEGAMENTO DELLA MESSA. TERMA DELLA SCODA NELLA VEDI DETTAGLIO
 - IL COLLEGAMENTO DELLA MESSA. TERMA DELLA SCODA NELLA VEDI DETTAGLIO
 NOTES
 100V AND 120V VERSIONS DIFFER FROM THE 230V VERSION FOR:
 - CONNECTION OF BOARD EARTH CABLE GEE DETAIL
 - CONNECTION OF BOARD EARTH CABLE GEE DETAIL

| | | | |
|----------------|---|----------------|---------------------------|
| DATE | 05/05/13 | SCALE | |
| DESIGN | BASSI, F. | APPROVED | REFA. G. |
| MATERIAL | | GEN.TOLERAN. | VOLUME (mm ³) |
| HEAT TREATMENT | | MOULD CODE | N° CAVITY |
| MODEL | CA. SAECO IMPR18 / P. / H. / V2 | 100V-120V-230V | DRAWING REVISION |
| DESCRIPTION | SCHEMA CABLAGGIO H08750 / 51 / 52 / 53 V2 | | |
| | WIRING LAYOUT H08750 / 51 / 52 / 53 V2 | | |
| | DRAWING CODE / ITEM CODE | | |
| | 421946001351 | | |

CA. PROPRIETÀ DI SAECO DESIGN. È INTERVIATA A TUTTI I TERMINI DI LEGGE. È VIETATO QUINDI RIPRODURRE, INVECIARE, RIFARE, O ALTRE MANIFESTAZIONI. LA RIPRODUZIONE DI QUESTO SCHEMA È RISERVATA E SOGGETTA A LEGGE. È VIETATO QUINDI RIPRODURRE, INVECIARE, RIFARE, O ALTRE MANIFESTAZIONI. THE PROPERTY OF THIS DRAWING IS RESERVED AND SUBJECT TO LAW. DISTRIBUTION AND REPRODUCTION TO OTHER PARTIES IS PROHIBITED.

A2
 UNI 9241-86

VALIDO PER
 PRODUZIONE
 MATERIAL REV. 00

NOTIFICAZIONE: ROSETTI MARKED WITH:
 (C) (E) (G) (H) (I) (J) (K) (L) (M) (N) (O) (P) (Q) (R) (S) (T) (U) (V) (W) (X) (Y) (Z)

NOTIFICAZIONE: ROSETTI MARKED WITH:
 (C) (E) (G) (H) (I) (J) (K) (L) (M) (N) (O) (P) (Q) (R) (S) (T) (U) (V) (W) (X) (Y) (Z)