

Service Service Service



Minuto

Service Manual

Rev. 03 May 2015

Table of contents	Page	Table of contents	Page
1. Introduction		4.2. Water circuit Minuto Class and Focus	2
1.1. Documentation required	1	4.3. Water circuit Minuto Pure	3
1.2. Tools and equipment required	1	4.4. Milk carafe	4
1.3. Material	1	4.5. Coffee cycle	5
1.4. Safety warnings	1	4.6. Single microswitch	6
1.5. Service Policy	2	4.7. Temperature sensor	6
1.6.1. External machine parts	3	4.8. Coffee grinder	7
1.6.2. Internal machine parts	6	4.9. Low bean level detection, dose quantity adjustment, coffee grinder blocked	7
2. Technical specifications		4.10. Dose self-learning (SAS)	8
2.1. Technical specifications	1	4.11. Water level detection (water tank)	9
2.2.1. Specification for the measurement of the coffee products temperature	2	4.12. Descaling request	9
2.2.2. Specification for the measurement of the milk products temperature	3	4.13. Water filter	10
2.3. Machine parameters and performance	5	5. Troubleshooting	
3. User instructions		5.1.1. Minuto Cappuccino test mode	1
3.1. Customer menu in the Minuto Cappuccino	1	5.1.2. SteamOut	7
3.2. Customer menu in the Minuto Cappuccino for USA	3	5.2.1. Minuto Cappuccino test mode for USA	8
3.3. Customer menu in the Minuto Class and Focus	5	5.2.2. SteamOut	15
3.4. Customer menu in the Minuto Class and Focus for USA	7	5.3.1. Minuto Focus/Class test mode	16
3.5. Customer menu in the Minuto Pure	9	5.3.2. SteamOut	22
3.6. Customer menu in the Minuto Pure for USA	11	5.4.1. Minuto Focus/Class test mode for USA	23
3.7. Operation, cleaning and maintenance	13	5.4.2. SteamOut	29
4. Operating logic		5.5.1. Minuto Pure test mode	30
4.1. Water circuit Minuto Cappuccino	1	5.5.2. Steam Out	37
		5.6.1. Minuto Pure test mode for USA	38
		5.6.2. Steam Out	45
		5.7. Error messages	46

All parts of this document are the property of Saeco International Group.

All rights reserved. This document and all the information herein is provided without liability deriving from any errors or omissions. Furthermore, no part may be reproduced, used or collected, except where express authorisation has been provided in writing or through a contractual agreement.

Table of contents		Page
6.	Standard checks	
6.1.	Repair schedule	1
6.2.	Service schedule	1
6.3.	Final test	2
7.	Disassembly	
7.1.	Outer Shell	1
7.2.	Coffee grinder	2
7.3.	Grinder blades	3
7.4.	Coffee grinder adjustment	4
7.5.1.	Two-way solenoid valve	5
7.5.2.	Carafe connection and hot water dispenser in Minuto Cappuccino	5
7.6.	Pin boiler	5
7.7.	Gear motor	6
7.8.	Central plate	6
7.9.	Pump	7
7.10.	Flow-meter	7
7.11.	Boiler	7
7.12.	CPU board	8
7.13.	Programming access for SSC (Saeco Service Center)	8
7.14.	KYB interface and display	8
7.15.	Fitting and removing Oetiker clamps	9
8.	Notes	
9.	Water circuit diagram	
10	Electrical diagram	

MODIFICATIONS TO SERVICE MANUAL				
From Rev.	To Rev.	Chapter	Inserted	Modified
REV.02	REV.03	01		Par.1.6.2. Internal machine parts (Modified the pictures for grinder)
		07		Par. 7.2.Coffee grinder Par. 7.3.Grinder blades Par. 7.4.Coffee grinder adjustment Par. 7.8.Central plate (Modified the pictures for grinder)



CHAPTER 1

INTRODUCTION

1.1 Documentation required

The following documentation is needed for repair procedures:

- Instruction booklet for specific model
- Technical documentation for specific model (diagrams, exploded view, symptom cure and service manual)

1.2 Tools and equipment required

As well as the standard equipment, the following is required:

Qty.	Description	Notes
1	Screwdriver	
1	Pliers for Oetiker clamps	
1	CC -A - Vdc tester	
1	Digital thermometer	Scale limit > 150°C
1	SSC (Saeco Service Center)	Programmer (for programming and diagnostics mode)

1.3 Material

Description	Notes
Thermal paste	Heating element > 200°C
Descaler	Saeco descaler
Grease solvent	Personal choice
Silicone grease	Safe to use with food

1.4 Safety warnings

We recommend you consult the technical manual of the machine before performing any maintenance work.

Observe all applicable standards relating to the repair of electrical appliances.

Always disconnect the power plug from the mains before beginning repair work.

Simply turning off the main machine power switch is not an adequate safety precaution.

This domestic appliance is rated as insulation class I.

On completion of the repair work, insulation and dielectric rigidity tests must be performed.

1.5 Service POLICY grid as used for coffee machine

For IN WARRANTY repairs is mandatory to use the single components (not the assembly) available in the exploded views of the coffee machines or of the specific components. If you find the information "SEE THE EXPLODED VIEW E....." in the assembly description field, it means that the single components of the assembly are available in the other pages of the exploded view. It's possible to use the assembly only if there is a specific Symptom Cure that include this possibility or when the single components are not available for the order.

List of principal assembly present in all our coffee machines

Components	Assembly use	Single components available
COFFEE GRINDER	<u>Only for OOW repairs</u>	YES , to consult the specific exploded-view of the machine or of the Coffee Grinder on website
BREWING UNIT	<u>Only for OOW repairs</u>	YES , to consult the specific exploded-view of the machine or of the Brewing unit on website
BOILER	<u>Only for OOW repairs</u>	YES , to consult the specific exploded-view of the machine on website
GEAR MOTOR	<u>Only for OOW repairs</u>	YES , to consult the specific exploded-view of the machine on website
FILTER HOLDER	<u>Only for OOW repairs</u>	YES , to consult the specific exploded-view of the machine on website
MILK CARAFE	<u>Only for OOW repairs</u>	YES , to consult the specific exploded-view of the machine on website
THERMAL CARAFE	<u>Only for OOW repairs</u>	YES , to consult the specific exploded-view of the Thermal Carafe on website
MILK ISLAND	<u>Only for OOW repairs</u>	YES , to consult the specific exploded-view of the Milk Island on website

1.6.1 External machine parts

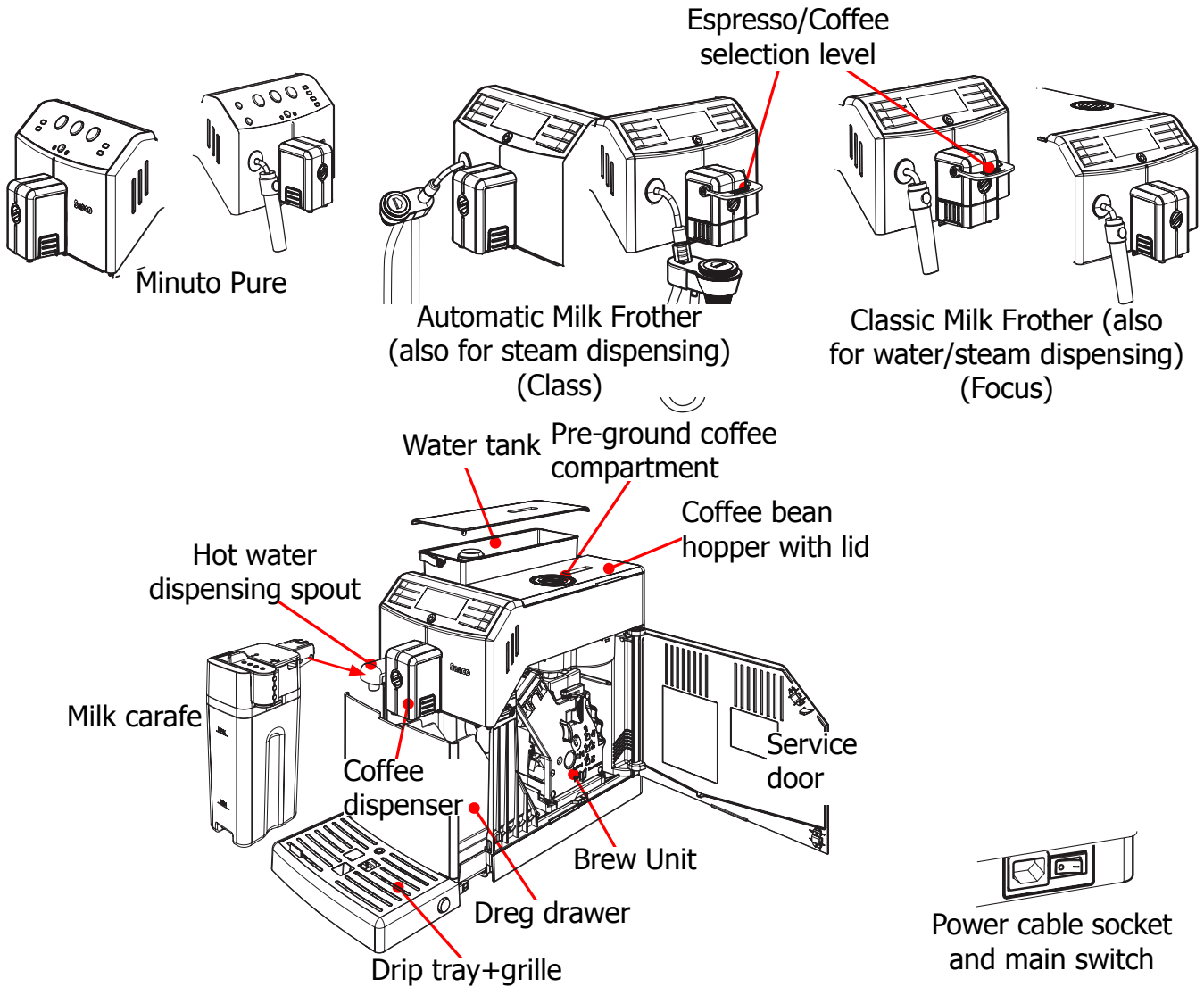

CAPPUCCINO

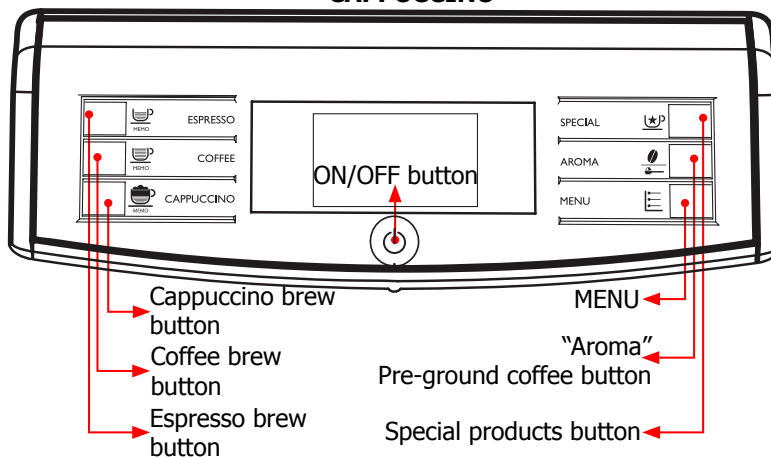

CLASS

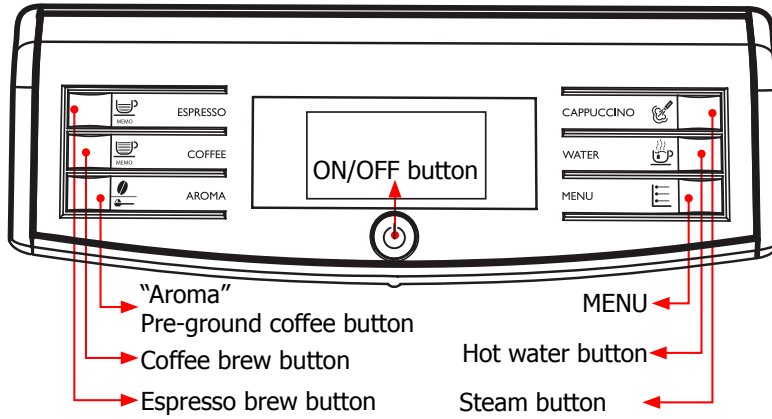

FOCUS

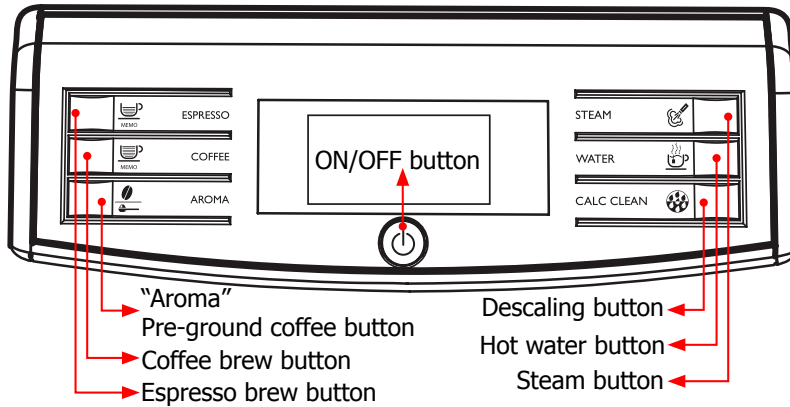

PURE

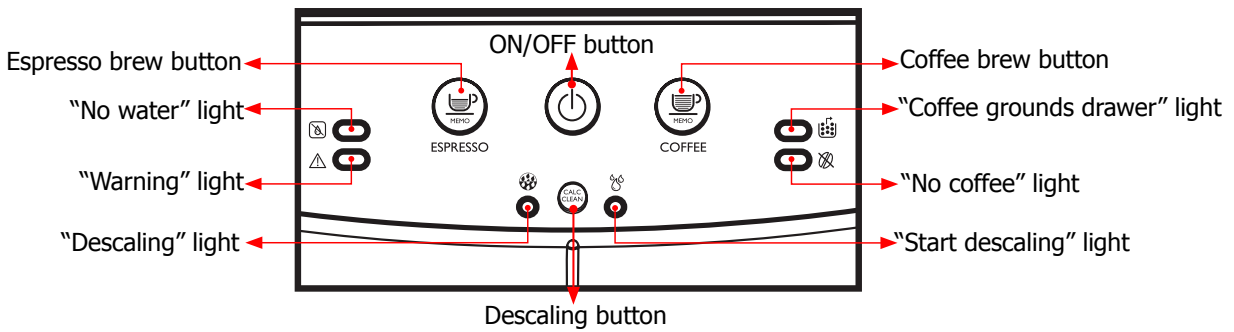

CAPPUCCINO for USA

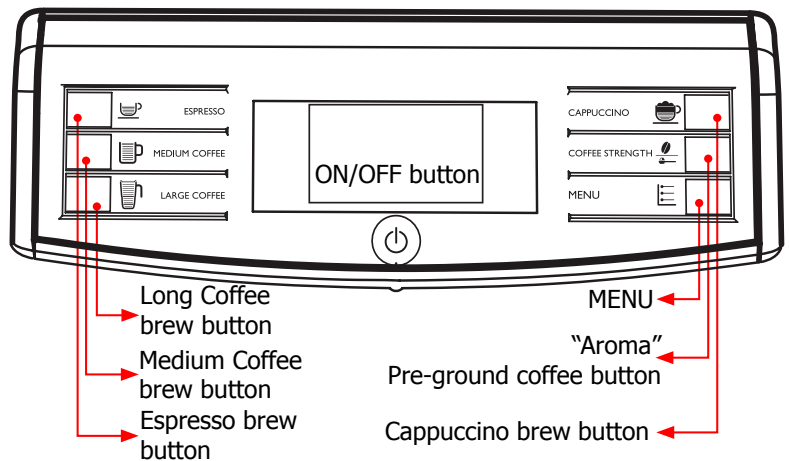
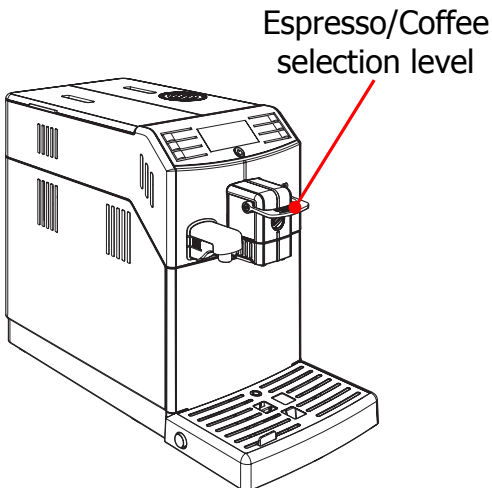

Automatic Milk Frother
(also for steam dispensing)
(Class)

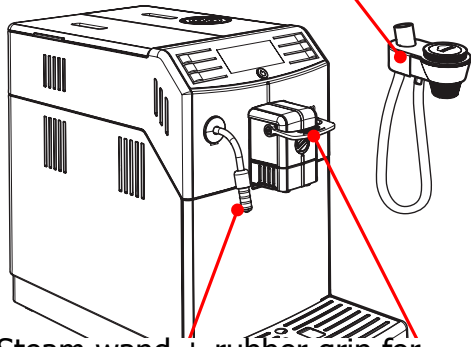

Steam wand + rubber grip for
Automatic Milk Frother
(also for hot water dispensing)

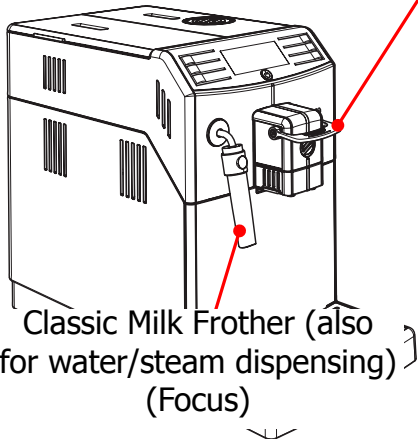

Classic Milk Frother (also
for water/steam dispensing)
(Focus)

Espresso/Coffee
selection level

CLASS
for USA

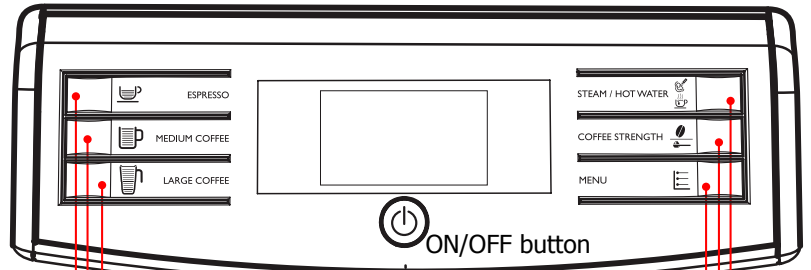

- Long coffee brew button
- Medium coffee brew button
- Espresso brew button
- Menu button
- "Aroma" Pre-ground coffee button
- Hot water/steam button

FOCUS
for USA

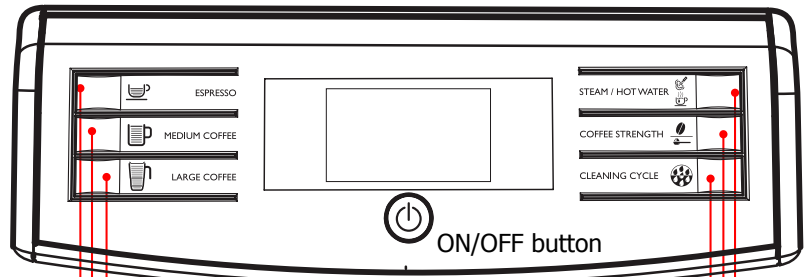

- Long coffee brew button
- Medium coffee brew button
- Espresso brew button
- Descaling button
- "Aroma" Pre-ground coffee button
- Hot water/steam button

PURE
for USA

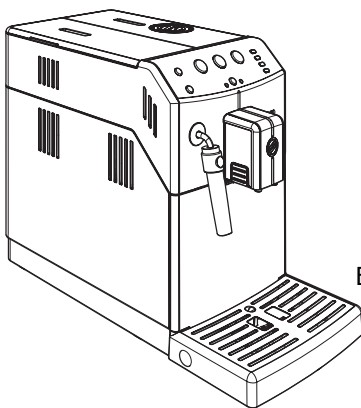

- Espresso brew button
- ON/OFF button
- Coffee brew button
- Steam button
- Hot water button
- Descaling cycle light
- Descaling button
- Rinse cycle light
- "No water" light
- Empty coffee grounds drawer" light
- "No coffee" light
- General warning light

1.6.2. Internal machine parts

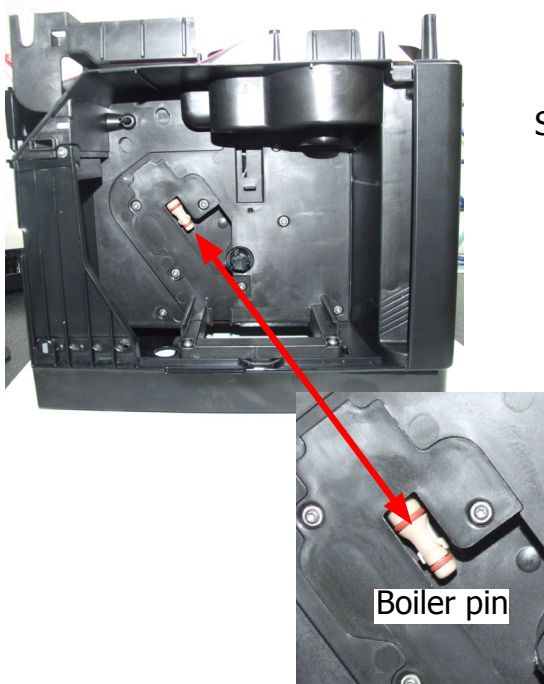
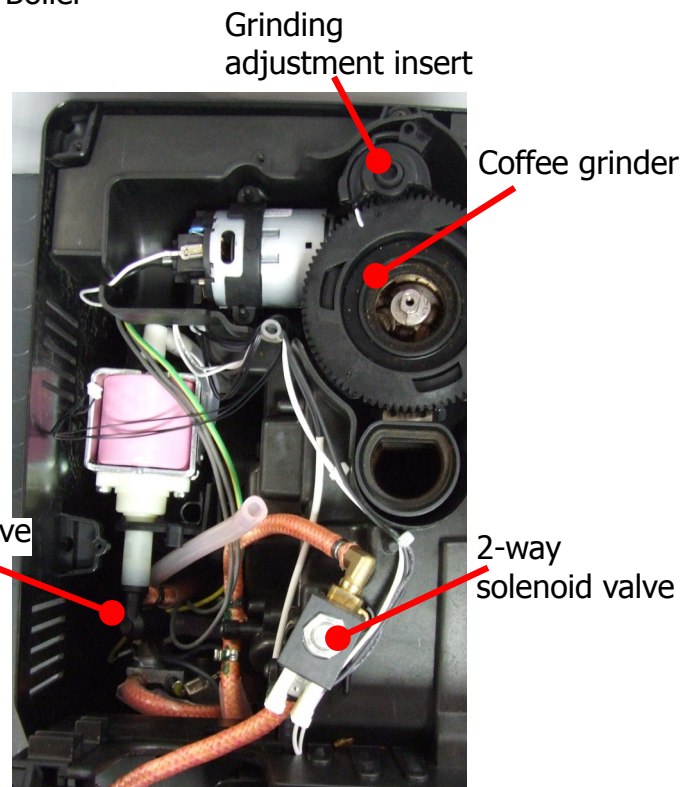
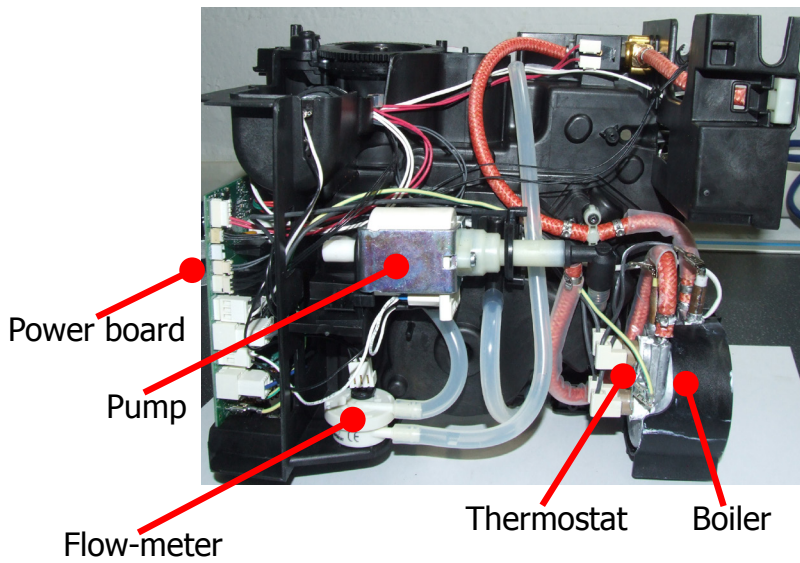



CHAPTER 2

TECHNICAL SPECIFICATIONS

2.1. Technical specifications

Power supply and output:	240 V~ 50 Hz 1850 W - 230 V~ 50/60 Hz 1850 W 120 V~ 60 Hz 1500 W
Temperature monitoring:	(NTC) variable resistor sensor - transmits the value to the electronic card
Safety system:	2 thermostats at 190°C one shot
Coffee heat exchanger output: Stainless steel	(230 V~) 1900 W - (120 V~) 1300 W - (100 V~) 1100 W for coffee, hot water and steam dispensing
Gear motor:	2 rotation directions; power supply 24VC
Pump:	Ulka Type EP5/S GW approx. 13-15 bar with reciprocating piston and thermal switch 100°C 48 W, 230V, 50 Hz, 120V, 60Hz 100V, 50/60 Hz
Overpressure valve:	Opening at approx. 16-18 bar
Water filter:	In tank
Coffee grinder:	Direct current motor with flat ceramic grinder blades
Automatic dosage:	Dose adjustment controlled by the electronic system
Power consumption:	During heating phase- approx. 5.6 A
Dimensions: W x H x D in mm:	215 x 330 x 429 mm / 8.5"x13"x16.9"
Weight:	6.7 kg / 14.77 lbs
Water tank capacity:	1.5 l
Coffee bean hopper capacity:	250 g. / 1 cup
Dreg drawer capacity:	15
Water circuit filling time:	Approx. 15 sec Max. on first filling cycle
Heating time:	Approx. 45 sec.
Grinding time:	Approx. 8-10 sec.

2.2.1. Specification for the measurement of the coffee products temperature.

The temperature is influenced by the flow from the dispenser and stratification of temperatures in the glass. In order to consider these phenomena and to introduce measures that allow comparisons in controlled conditions, below guidelines must be followed:

Conditions:

- a) Water temperature in tank: 23°C (+/-2°C).
- b) It must be used a plastic cup (see picture N°1).
- c) It must be used a thermocouple thermometer (e.g. type K - see picture N°2).
- d) The coffee machine is tested without any change of parameters or calibrations, which may affect the temperature of products, so the measurement of temperature must be done with machine in default factory setting.

Procedure:

1. The temperature must be measured in the cup, immediately after dispensing. Cup has to be placed on a non-metal surface using a thermocouple thermometer.
2. The temperature in the cup is measured by immersing the probe of the thermometer up to touch the bottom. The probe then must be moved in a circular motion for 5/6 rotations. At the of the rotations, stop in the center of the cup.
3. The highest temperature measured during the rotations is the value we are searching for, and that must be reported;
4. Test measurement: from end of dispensing to the end of rotations must be completed within 12 seconds.

Limits of acceptability

The acceptance limits are divided by features and products and are the following:

Espresso Coffee Italy Q.ty 25/40 gr.

Temperature of 1st product 69°C ≤ 85°C

Temperature of 2nd product 72°C ≤ 85°C

Coffee Q.ty 70/120 gr.

Temperature of 1st product 69°C ≤ 85°C

Temperature of 2nd product 72°C ≤ 85°C

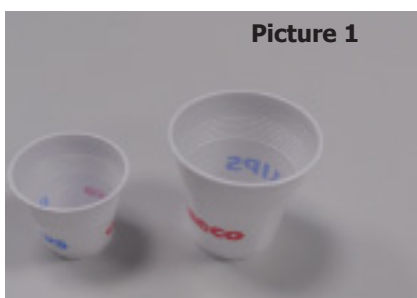

2.2.2. Specification for the measurement of the Milk products temperature.

Milk evaluation

To carry out the test, a partially skimmed UHT milk with a percentage of grease between 1.5-1.8% at a refrigerator temperature $T_{refr.}$ (between 4 to 10°C) must be used.

The milk product must be checked on a beaker of 250 ml of capability and with an inner diameter of 70mm, brewing 100gr of product.

Parameters to be respected:

The parameters to be respected are: milk temperature and height of the cream. Each of these parameters, however, must be evaluated depending on the type of system used for the production of hot milk.

Actually three types of devices are present on the appliances:

- Manual system (pannarello)
- Semi-Automatic system (cappuccinatore)
- Automatic system (carafe, Pinless wonder system, etc.)

Milk temperature in the beaker:

System without Pinless Wonder: e.g. Xelsis, Exprelia, Syntia, Intelia.

With milk at $T_{refr.}$ (about 4-10 °C): $\rightarrow \Delta \geq 36$

System with Pinless Wonder: New royal, Energica Pure, Intelia EVO Latte.

With milk at $T_{refr.}$ (about 4-10 °C): $\rightarrow \Delta \geq 45$

Height of the milk cream in the beaker:

Manual system (pannarello)

$\geq 15\text{mm}$ on 100gr. of brewed product

Semi-automatic system (cappuccinatore)

$\geq 20\text{mm}$ on 100gr. of brewed product

Automatic system: carafe, cappuccinatore, Pinless wonder (New Royal, Energica Pure, Intelia EVO latte)

$\geq 20\text{mm}$ on 100gr. of brewed product

How to measure the temperature of the milk.

- 1) The measurement is carried out in the beaker, immediately after the end of milk brew, positioned on a non-metallic surface, using a thermocouple thermometer (eg. Type K). Stop the preparation of mixed product: at the end of milk brewing, where "One Touch product" function is present.
- 2) The temperature is measured by immersing the probe of the thermometer, positioning the probe inside the beaker at about 10mm from the bottom of the container, then the probe moves in a circular motion for 3-5 turns, stopping at the end, at the center of the beaker. It detects the maximum temperature reached in a time of relief between 3 to 5 seconds. It is important the mixing of milk before the measurement at 10mm from the bottom of the beaker. If the mixing is correct, temperature, for a few fractions of a second, during the measurement should not oscillate.

How to measure the milk cream.

The temperature (T_{refr} or T_{amb}) of the milk doesn't affect as much the test result on measuring the milk cream; by convection is assumed to always use milk at refrigerator temperature T_{refr} .

Manual systems (Pannarello)

Pour 100cc. of milk at T_{refr} . in a beaker of 250 ml of capacity and with a inner diameter of 70 mm; with machine in steam mode:

1. Open the steam knob to discharger water circuit for 4 sec, then close the knob.
2. Place the beaker with the frother dipped in milk, open the steam knob to maximum and start the chronometer.
3. After about 30 to 60 seconds, close the knob and check the result on milk.

Semi-automatic systems (cappuccino)

Pours milk at T_{refr} . in a container ; with the machine in steam mode:

1. Open the steam knob to discharge water circuit for 4 sec. then close the knob.
2. Insert the silicone tube in the milk container, placing a beaker of 250 ml capacity and with an inner diameter of 70 mm under the cappuccino maker and open the steam knob.
3. After having provided 100gr. of product, close the knob and check the result obtained on milk. Note: The same applies to machines which have a steam key on the user interface and a solenoid valve in place of the steam tap.

Automatic: Carafe, Cappuccino Pinless wonder (New Royal, Energica Pure, Intelia EVO Latte), etc..

After setting the machine to delivery of 100gr. of product:

1. Launch the "hot milk" function.
2. Collect the product in a beaker with a 250ml of capacity and with an inner diameter of 70 mm, and verify the result obtained on milk. Carry out the test using milk at a T_{refr} .

In case the machine allows modify of the emulsion through the menu, use the machine with the emulsion set to the default value.

Related to the above testing procedure derives the following table of acceptability:

Manual, Semi-Automatic and Automatic's Milk System	
Grams of Product	Minimun Height of the milk cream
≥ 130	≥ 30mm
120	≥ 25mm
110	≥ 22mm
100	≥ 20mm
90	≥ 16mm
80	≥ 13mm
70	≥ 11mm

NB: To verify more accurately the height of the cream, a practical expedient dictated by experience is to add to the product just delivered a small amount of coffee. The addition of coffee immediately put in evidence the surface of separation between liquid and cream.

2.3. Machine parameters and performance

PRODUCT QUANTITY	Minimum quantity (Puls.)	Default quantity (Puls.)	Maximum quantity (Puls.)	User programmable	Programm. by Production / Service
Espresso	50	165	600	Yes	No
Long coffee	70	440	600	Yes	No
Hot water	Continues until the water supply has been exhausted (capacitive sensor)				
Steam pannarello (frother)	Continues until the water supply has been exhausted (capacitive sensor)				

Descaling cycle frequency			
Hardness	Water hardness	Without water filter	With water filter
1	Soft (up to 7°dH)	240 litres (480,000 pulses)	480 litres (960,000 pulses)
2	Medium (7° - 14°dH)	120 litres (240,000 pulses)	240 litres (480,000 pulses)
3	Hard (15° - 21°dH)	60 litres (120,000 pulses)	120 litres (240,000 pulses)
4	Very hard (over 21°dH)	30 litres (60,000 pulses)	60 litres (120,000 pulses)

The default water hardness level is 4. Each litre of water corresponds to approximately 2,000 pulses.

In the machines where is not possible change the water hardness the default hardness level is 3.

DREG DRAWER	Description and values
Time-out for dreg drawer	5 sec.
Reset dreg counter	Dreg emptying alarm, if the dreg drawer is removed for more than 5 seconds.

STANDBY	Description and values
Inlet time (default)	30 minutes
Inlet time programmed by Production/Service	Yes
Boiler temperature during Standby	Boiler OFF

WATER TANK	Description
Water reserve (pulses) with water filter	200
Water reserve (pulses) with no water filter	200
Water reserve modifiable by Production/Service departments	No
"Fill tank" alarm	Yes
"No tray" alarm	Yes (Fill tank)
Water mains	No



CHAPTER 3

USER INSTRUCTIONS

3.1. Customer menu in the Minuto Cappuccino

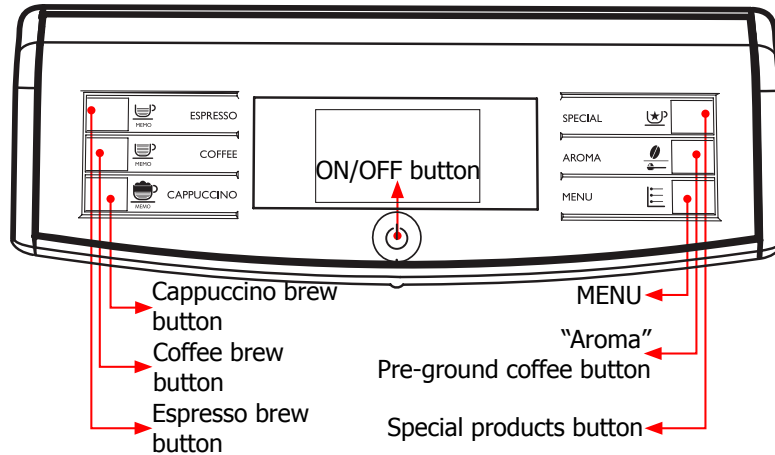

This machine is equipped with a colour-coded system to make your understanding of the display signals easier.

The icons are colour-coded according to the traffic light principle.

Machine ready signals (**GREEN** colour)

	The machine is ready to brew products.		Milk froth brewing.
	The machine is ready to brew pre-ground coffee.		The machine is frothing the milk for the cappuccino.
	The machine is brewing one cup of espresso.		The machine is brewing the coffee for the cappuccino
	The machine is brewing one cup of coffee.		The machine is programming the amount of milk to dispense for cappuccino.
	The machine is brewing two cups of espresso.		The machine is programming the amount of coffee to be brewed for cappuccino.
	The machine is brewing two cups of Coffee.		The machine is programming the amount of milk to dispense for milk froth.
	The machine is programming the amount of coffee to be brewed.		Insert the water dispensing spout and press the "MEMO" button to start dispensing. Press "MEMO" to exit.
	Coffee brewing using pre-ground coffee in progress.		The machine will remind the user that the carafe must be inserted.
	Milk froth or hot water selection.		The machine will remind the user that the carafe must be inserted when programming a product containing milk.
	Hot water dispensing.		

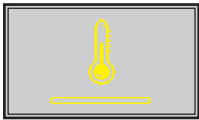
Machine ready signals (**YELLOW** colour)

The machine is heating up to brew beverages or dispense hot water/steam.

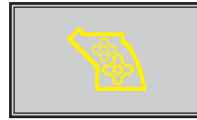

The brew group is being reset due to machine reset.

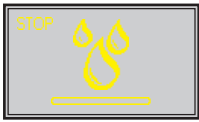

The machine is performing the rinse cycle. Wait until the machine has completed the cycle.

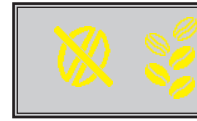

Refill the coffee bean hopper with coffee beans and restart the cycle.



The machine needs the "INTENZA+" water filter to be replaced.



The machine automatically primes the water circuit.

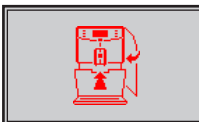

The machine needs to be descaled. Press the "☕" button to start the descaling process. Follow the steps described in the "Descaling" chapter of this manual. If you want to descale later, press the "☕" button to continue using the machine. Please note that not descaling your machine will ultimately make it stop working properly. In this case repair is NOT covered under your warranty.

Machine ready signals (**RED** colour)

Completely insert the drip tray with the coffee grounds drawer into the machine and close the service door.



Fill the coffee bean hopper and refit the lid.

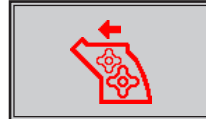
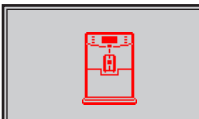

The brew group must be inserted into the machine.



Empty the coffee grounds drawer. Wait about 5 seconds before reinserting it.



Fill the water tank.



Turn off the machine. After 30 seconds, turn it on again. Try this 2 or 3 times. If the machine does not start, contact the Philips SAECO hotline in your country and quote the error code shown on the display. The contact details can be found in the warranty booklet packed separately or on www.philips.com/support.

3.2. Customer menu in the Minuto Cappuccino for USA

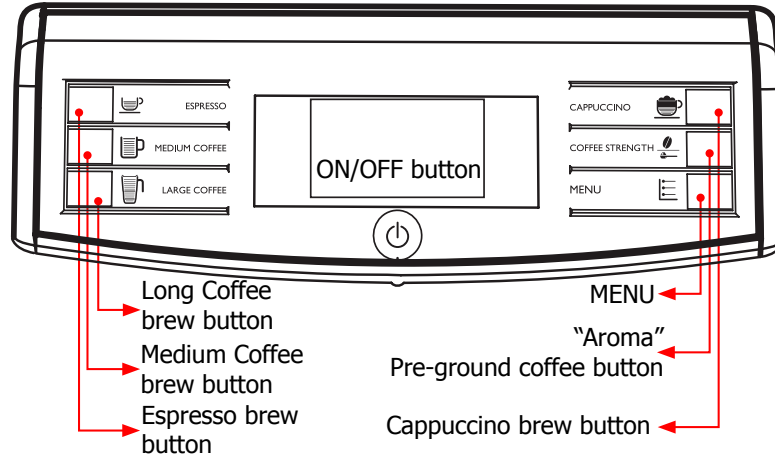

This machine is equipped with a colour-coded system to make your understanding of the display signals easier.

The icons are colour-coded according to the traffic light principle.

Machine ready signals (**GREEN** colour)

	The machine is ready to brew products.		Select the programming menu or special beverages menu.
	The machine is ready to brew pre-ground coffee.		Froth milk or hot water selection.
	The machine is brewing one cup of espresso.		Hot water dispensing.
	The machine is brewing two cups of espresso.		Milk froth brewing.
	The machine is programming the amount of espresso to be brewed.		The machine is frothing the milk for the cappuccino.
	Coffee brewing using pre-ground coffee in progress.		The machine is brewing the coffee for the cappuccino
	The machine is brewing one cup of medium coffee.		The machine is programming the amount of milk to dispense for cappuccino.
	The machine is programming the amount of medium coffee to be brewed.		The machine is programming the amount of coffee to be brewed for cappuccino.
	The machine brewing one cup of long coffee.		The machine is programming the amount of milk to dispense for froth milk.
	The machine is programming the amount of long coffee to be brewed.		

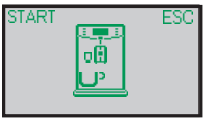

Insert the water dispensing spout and press the "☕" button to start dispensing. Press "☕" to exit.

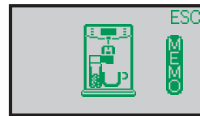

The machine will remind the user that the carafe must be inserted when programming a product containing milk.



The machine will remind the user that the carafe must be inserted.

Machine ready signals (**YELLOW colour**)

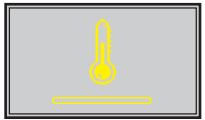

The machine is in warm-up phase to brew beverages or dispense hot water/steam.

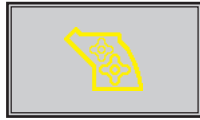

The brew group is being reset due to machine reset.



The machine is performing the rinse cycle. Wait until the machine has completed the cycle.



Fill the coffee bean hopper with coffee beans, refit the lid and restart the cycle.



The machine needs the "INTENZA+" water filter to be replaced.



The machine automatically primes the water circuit.



The machine needs to be descaled. Press the "☕" button to start the descaling process. Follow the steps described in the "Descaling" chapter of this manual. If you want to descale later, press the "☕" button to continue using the machine. Please note that not descaling your machine will ultimately make it stop working properly. In this case repair is NOT covered under your warranty.

Machine ready signals (**RED colour**)

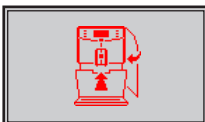

Completely insert the drip tray with the coffee grounds drawer into the machine and close the service door.



Fill the coffee bean hopper.



The brew group must be inserted into the machine.



The brew group must be inserted into the machine.



Empty the coffee grounds drawer. Wait about 5 seconds before placing it back.



Fill the water tank.



Set the "ESPRESSO" or "COFFEE" selection lever to "ESPRESSO" within 30 seconds to complete brewing.



Set the "ESPRESSO" or "COFFEE" selection lever to "COFFEE" within 30 seconds to complete brewing.



A beverage has been selected without the coffee bean hopper inner lid on the machine. Place the coffee bean hopper inner lid on the machine within 30 seconds to complete brewing.



Turn off the machine. After 30 seconds, turn it on again. Try this 2 or 3 times. If the machine does not start, contact the Philips SAECO hotline in your country and communicate the Error-code which you see on the display. You can find its contact details in the warranty booklet packed separately or on www.philips.com/support.

3.3. Customer menu in the Minuto Class and Focus

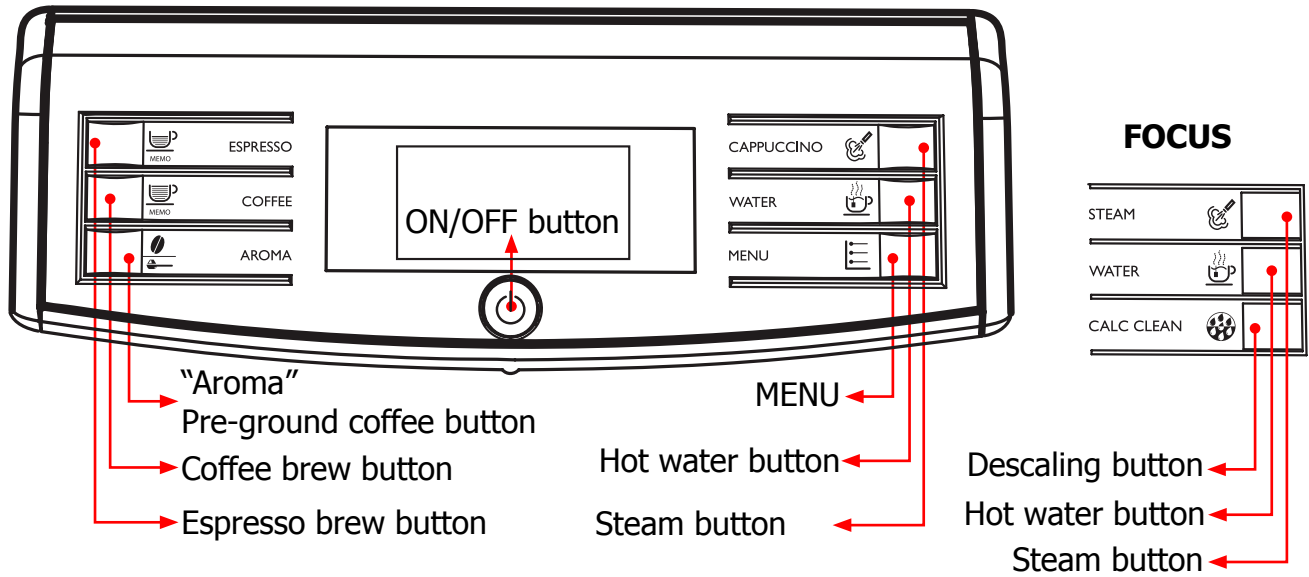

This machine is equipped with a colour-coded system to make your understanding of the display signals easier.

The icons are colour-coded according to the traffic light principle.

Machine ready signals (**GREEN colour**)

- | | | | |
|--|---|--|---|
| | The machine is ready to brew products. | | The machine is brewing one cup of Coffee. |
| | The machine is ready to brew pre-ground coffee. | | The machine is brewing two cups of espresso. |
| | Hot water dispensing. | | The machine is brewing two cups of Coffee. |
| | Steam dispensing. | | The machine is programming the amount of coffee to be brewed. |
| | The machine is brewing one cup of espresso | | Coffee brewing using pre-ground coffee in progress. |

Machine ready signals (**YELLOW colour**)

- | | | | |
|--|---|--|---|
| | The machine is heating-up to brew beverages or dispense hot water. | | The machine needs the "INTENZA+" water filter to be replaced. |
| | The machine performs the rinsing cycle. Wait until the machine has completed the cycle. | | The brew group is being reset due to machine reset. |



Refill the coffee bean hopper with coffee beans and restart the cycle.



Prime the circuit.

The machine needs to be descaled. Press the "  " button to enter the descaling menu.



If you want to descale later, press the "  " button to continue using the machine.

Please note that not descaling your machine will ultimately make it stop working properly. In this case repair is NOT covered under your warranty

Machine ready signals (**RED colour**)

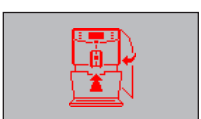

Insert the drip tray with the coffee grounds drawer into the machine and close the service door.



The brew group must be inserted into the machine.

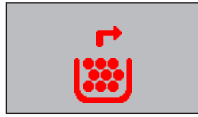

Empty the coffee grounds drawer.



Fill the coffee bean hopper.



Fill the water tank.

Turn off the machine. After 30 seconds, turn it on again. Try this 2 or 3 times.



If the machine does not start, contact the Philips SAECO hotline in your country and communicate the the Error-code which you see on the display. You can find its contact details in the warranty booklet by-packed separately or on www.philips.com/support.

3.4. Customer menu in the Minuto Class and Focus for USA

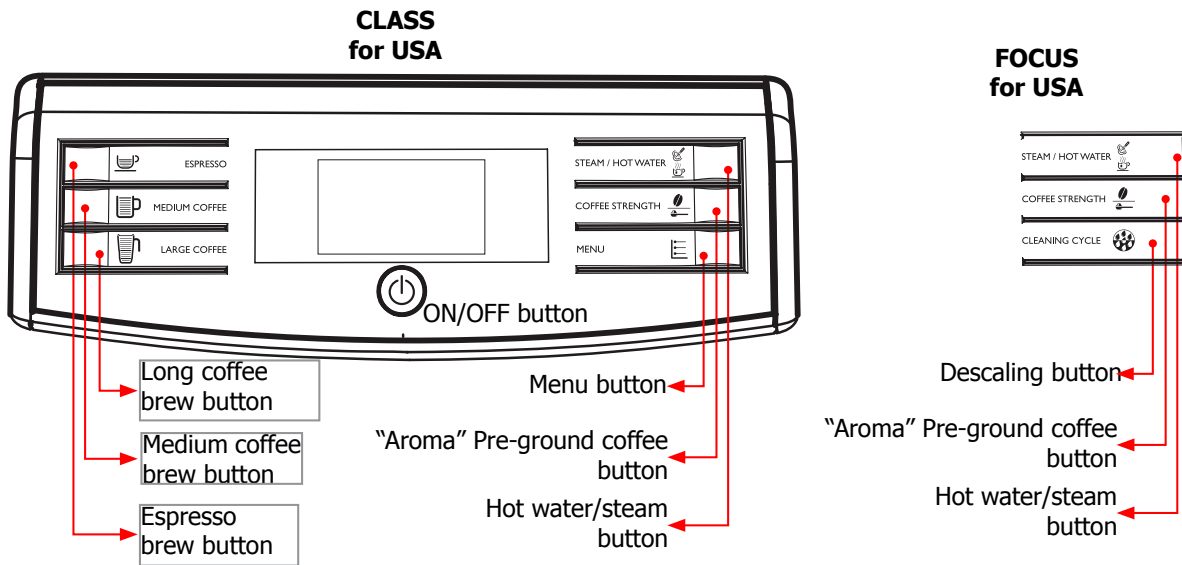







This machine is equipped with a colour-coded system to make your understanding of the display signals easier.

The icons are colour-coded according to the traffic light principle.









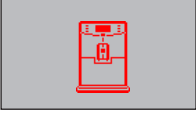

Machine ready signals (**GREEN colour**)

- | | | | |
|--|---|--|--|
| | The machine is ready to brew products. | | The machine is programming the amount of coffee to be brewed. |
| | The machine is ready to brew pre-ground coffee. | | Espresso brewing using pre-ground coffee in progress. |
| | Steam or hot water selection. | | The machine is brewing one cup of medium coffee. |
| | Hot water dispensing. | | The machine is programming the amount of medium coffee to be brewed. |
| | Steam dispensing. | | The machine is brewing one cup of long coffee. |
| | The machine is brewing one cup of espresso | | The machine is programming the amount of long coffee to be brewed. |
| | The machine is brewing two cups of espresso | | |

Machine ready signals (**YELLOW colour**)

		Class		
	The machine is in warm-up phase to brew beverages or dispense hot water/steam.			
		Focus		
	The machine is heating-up to brew beverages or dispense hot water.			Refill the coffee bean hopper with coffee beans. Put back the coffee bean hopper lid and restart the cycle.
	The machine needs the "INTENZA+" water filter to be replaced.			Prime the circuit.
	The brew group is being reset due to machine reset.			
	The machine needs to be descaled. Press the "☺" button to enter the descaling menu.			
	If you want to descale later, press the "☺☺☺☺☺" button to continue using the machine.			
	Please note that not descaling your machine will ultimately make it stop working properly. In this case repair is NOT covered under your warranty			

Machine ready signals (**RED colour**)

	Completely insert the drip tray with the coffee grounds drawer into the machine and close the service door.		The brew group must be inserted into the machine.
			Empty the coffee grounds drawer. Wait about 5 seconds before placing it back.
	Fill the coffee bean hopper.		Fill the water tank.
	Set the "ESPRESSO" or "COFFEE" selection lever to "ESPRESSO" within 30 seconds to complete brewing.		
	Set the "ESPRESSO" or "COFFEE" selection lever to "COFFEE" within 30 seconds to complete brewing.		
	A beverage has been selected without the coffee bean hopper inner lid on the machine. Place the coffee bean hopper lid on the machine within 30 seconds to complete brewing.		
	Turn off the machine. After 30 seconds, turn it on again. Try this 2 or 3 times. If the machine does not start, contact the Philips SAECO hotline in your country and communicate the the Error-code which you see on the display. You can find its contact details in the warranty booklet by-packed separately or on www.philips.com/support .		

3.5. Customer menu in the Minuto Pure

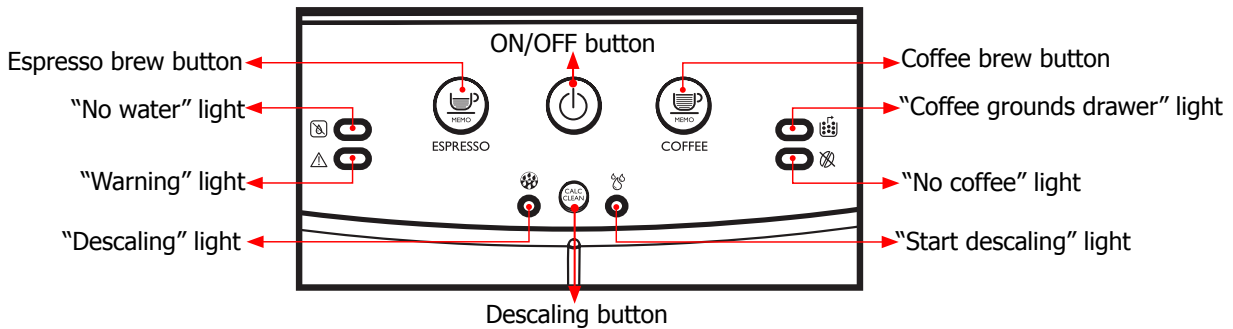

Warning signals

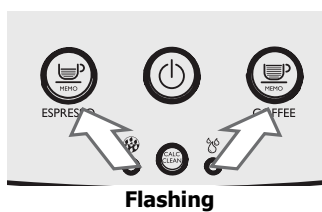

The machine is busy and is performing one of the following operations:
 - Warm-up
 - Automatic rinse.

The machine automatically manages phases in order to complete the operations.

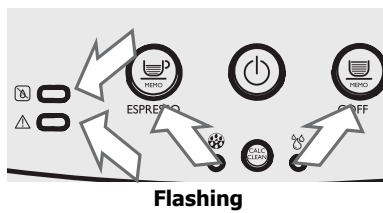

The machine is priming the circuit.



The machine is brewing two cups of coffee.

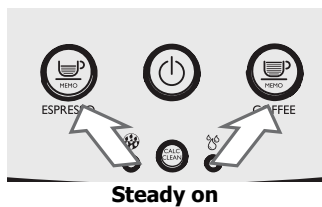

The machine is ready to brew products.

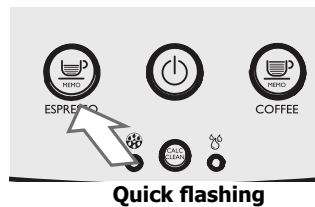

The machine is programming the amount of espresso to brew.

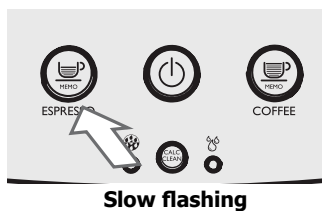

The machine is brewing one cup of espresso.



The machine is programming the amount of coffee to be brewed.



The machine is brewing one cup of coffee.



Fill the water tank.



The machine is brewing two cups of espresso.



Completely insert the drip tray with the coffee grounds drawer into the machine and close the service door.

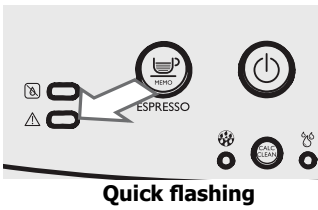

The brew group is being reset due to machine reset.

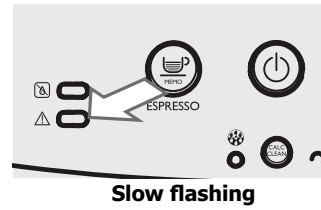

Fit the Brew Group.





Empty the coffee grounds drawer.

While emptying the coffee grounds drawer.

Note:

The coffee grounds drawer should only be inserted after

completion of the reset that takes place when the “” light turns off and the “” light becomes steady on.

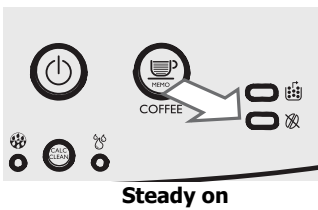
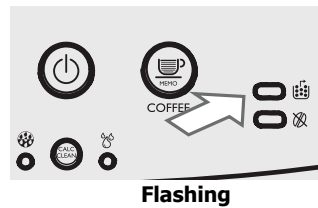

Refill the coffee bean hopper with coffee beans and restart the cycle.



The machine needs to be descaled. Follow the steps described in the “Descaling” chapter of this manual.

Please note that not descaling your machine will ultimately make it stop working properly. In this case repair is NOT covered under your warranty.



Turn off the machine. After 30 seconds, turn it on again. Repeat the procedure 2 or 3 times.

If the machine does not start, contact the Philips SAECO hotline in your country.

3.6. Customer menu in the Minuto Pure for USA

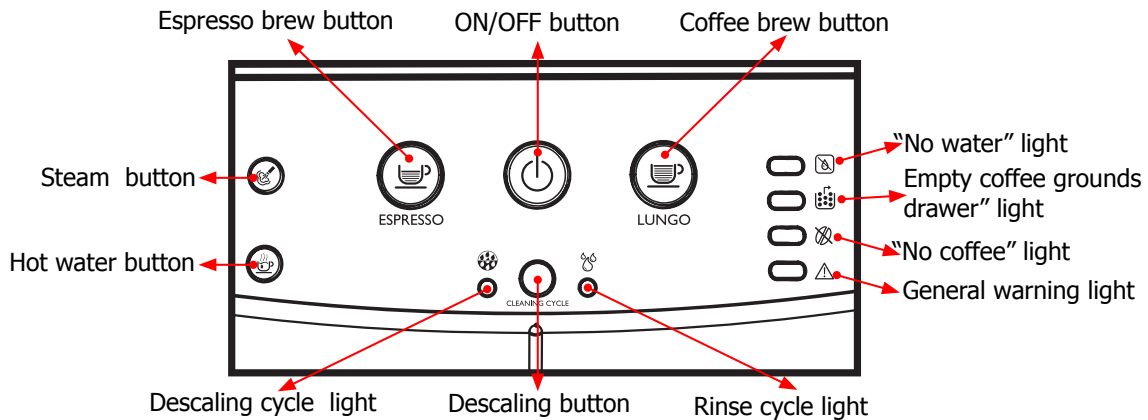

Flashing

The machine is performing one of the following operations:
- Warm-up
- Automatic rinse.



“☕” Steady on and “⊠” and “⚠” Flashing

You have to prime the machine by pressing the espresso button. Once pressed, the “☕” button turns off. During priming the “⊠” and “⚠” keep on flashing. They stop flashing when the priming is finished.



Steady on

The machine is ready for use.



Quickly double flashing

The machine is brewing two cups of coffee.



Flashing slowly

The machine is brewing one cup of coffee.

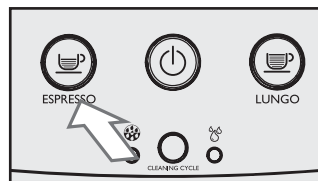

Flashing Quickly

The machine is programming the amount of espresso to brew.

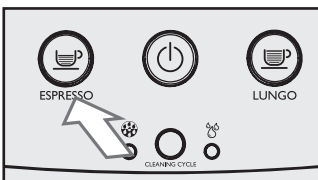

Flashing slowly

The machine is brewing one cup of espresso.

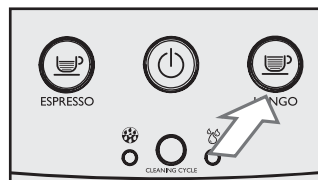

Flashing Quickly

The machine is programming the amount of coffee to be brewed.



Quickly double flashing

The machine is brewing two cups of espresso.



Flashing slowly

The machine is dispensing steam.



Flashing Quickly

The machine is in the stop steam dispensing phase



Flashing slowly

The machine is dispensing hot water.

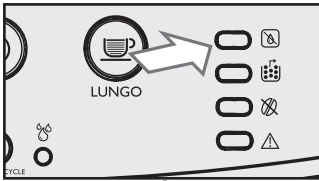

Steady on

Fill the water tank.

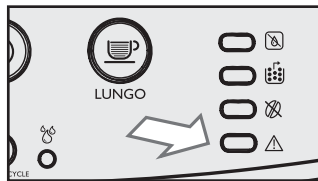

Steady on

Completely insert the drip tray with the coffee grounds drawer into the machine and close the service door.

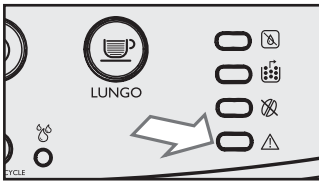

Flashing Quickly

The brew group is being reset due to machine reset.

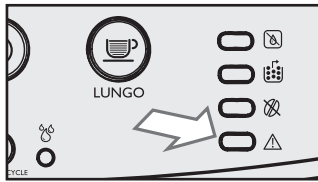

Flashing slowly

Insert the brew group properly.

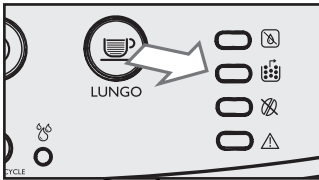

Steady on

Empty the coffee grounds drawer.

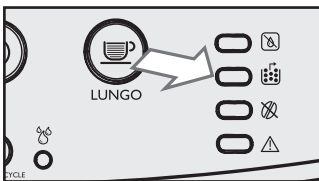

Flashing

The coffee grounds drawer is not inserted into the machine. Wait a few seconds till the "☒" goes out and the "⚠" is steady on. Then insert the coffee grounds drawer in the machine and close the service door.

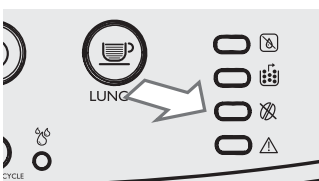

Steady on

Refill the coffee bean hopper with coffee beans and try again to make a coffee. The light turns off only when the bean hopper lid has been placed back. It is possible to dispense steam and hot water when this warning light shows.

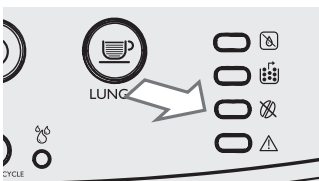

Flashing slowly

The bean hopper lid has been removed after having selected a coffee product. Put the lid back on.

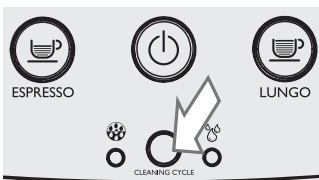

Steady on

The machine needs to be descaled. Follow the steps described in the "Descaling" chapter of this manual. Please note that not descaling your machine will ultimately make it stop working properly. In this case repair is NOT covered under your warranty.



All lights flashing simultaneously

Turn off the machine. Turn it back on after 30 seconds. Repeat the procedure 2 or 3 times. If the machine does not start, contact the Philips SAECO hotline in your country (contact details in the warranty booklet)

3.7. Operation, cleaning and maintenance

Operating the machine		
1	Fill water tank	
2	Fill the coffee bean hopper	
3	Switch on the appliance	
4	Press the button to start the appliance	
5	Heating	When the heating phase begins, wait for it to finish
6	Rinse	Carry out a rinse cycle for the internal circuits
7	Machine ready	The machine is ready to dispense beverages

CLEANING AND TECHNICAL SERVICING		
A	Empty the dregs drawer	When indicated
B	Empty the drip tray	As necessary
C	Clean the water tank	Weekly
D	Clean the coffee bean hopper	As necessary
E	Clean the casing	As necessary
F	Clean the brewing unit	Every time the coffee bean hopper is filled or weekly
	Lubricate the brewing unit	After 500 dispensing cycles or when the grease is no longer present on the brewing unit
	Clean the unit housing	Weekly
H	Descaling	When indicated

Descaling cycle frequency			
Hardness	Water hardness	Without water filter	With water filter
1	Soft (up to 7°dH)	240 litres (480,000 pulses)	480 litres (960,000 pulses)
2	Medium (7° - 14°dH)	120 litres (240,000 pulses)	240 litres (480,000 pulses)
3	Hard (15° - 21°dH)	60 litres (120,000 pulses)	120 litres (240,000 pulses)
4	Very hard (over 21°dH)	30 litres (60,000 pulses)	60 litres (120,000 pulses)



CHAPTER 4

OPERATING LOGIC

4.1. Water circuit Minuto Cappuccino

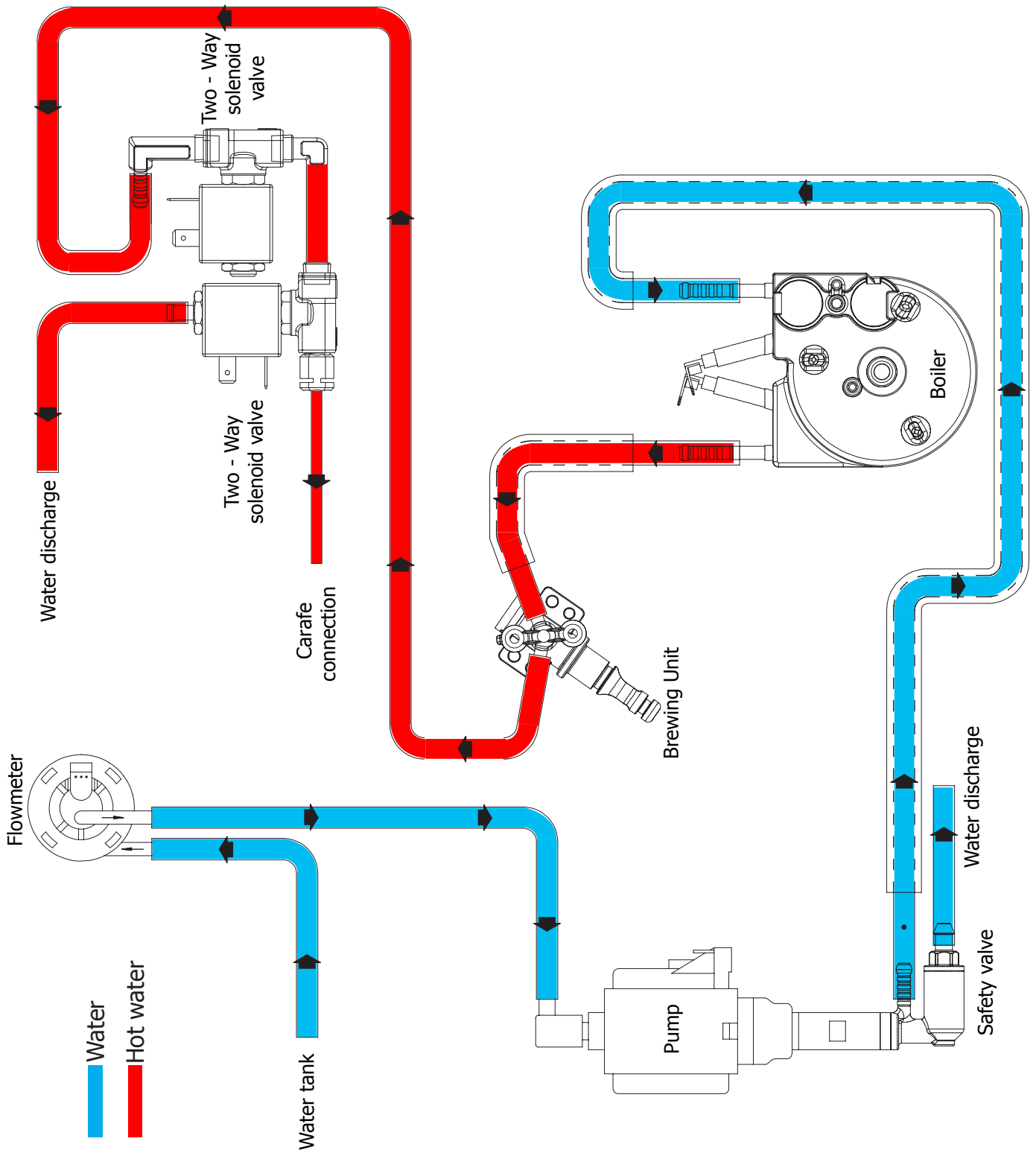

4.2. Water circuit Minuto Class and Focus

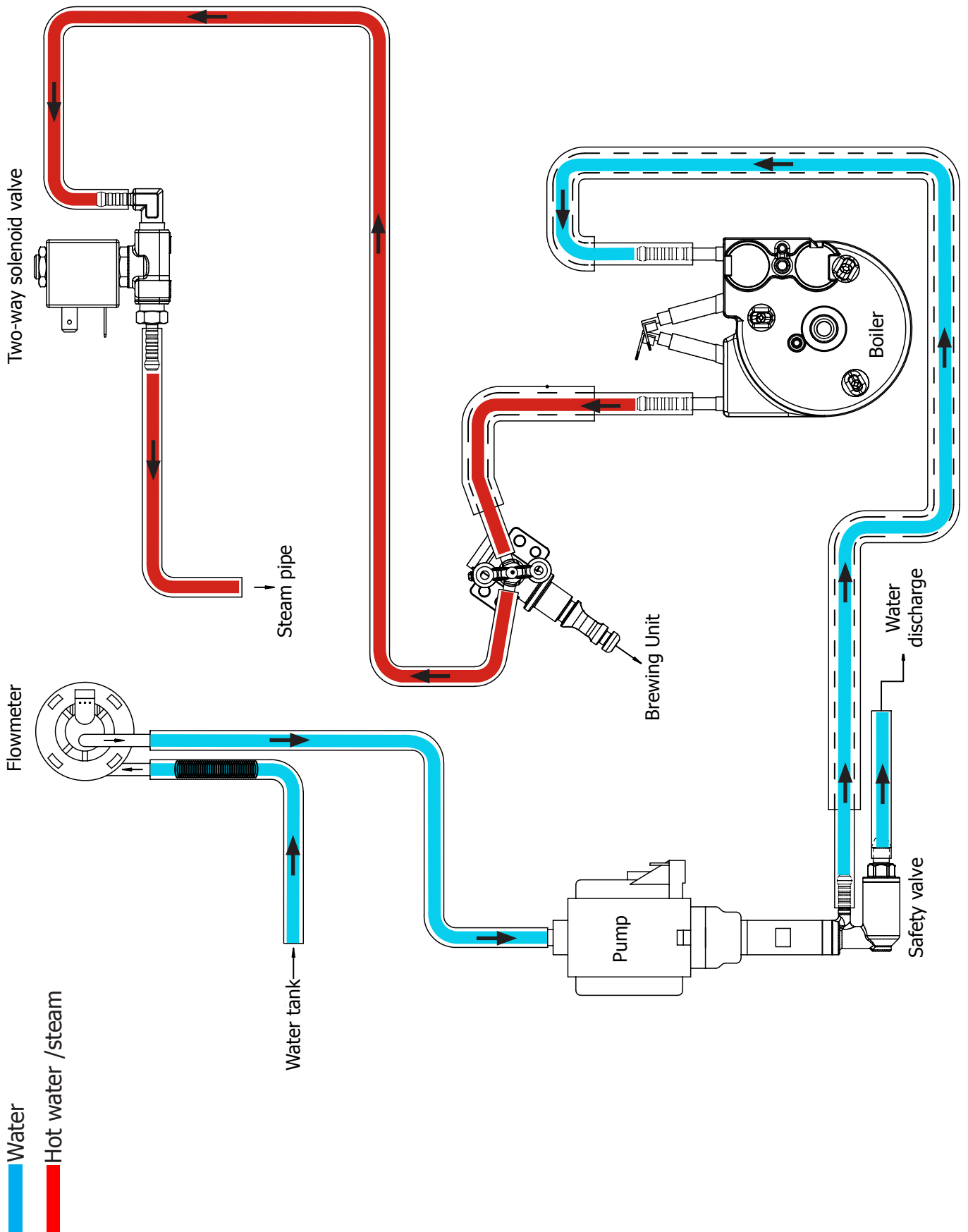

4.3. Water circuit Minuto Pure

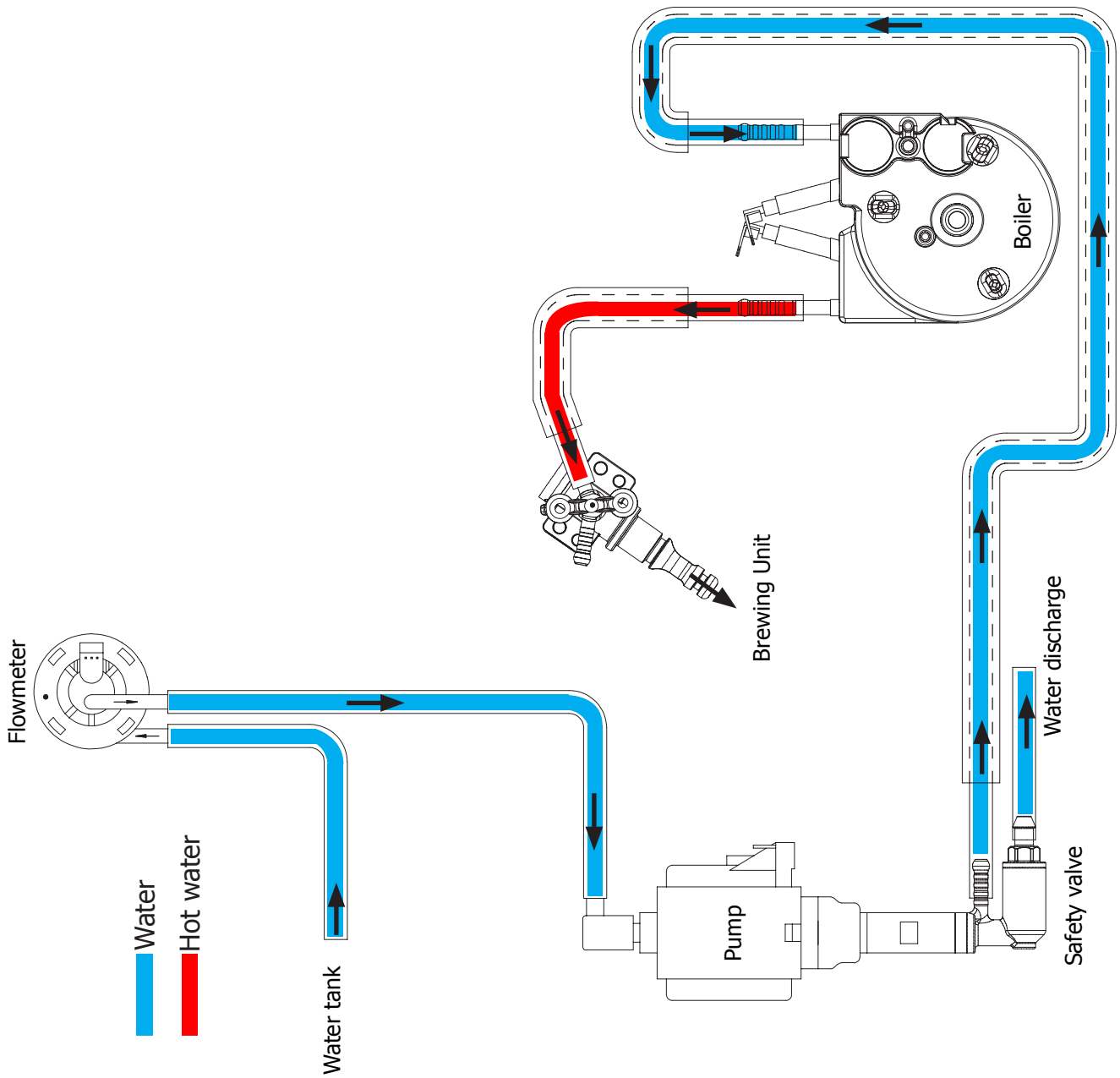

4.4. Milk Carafe

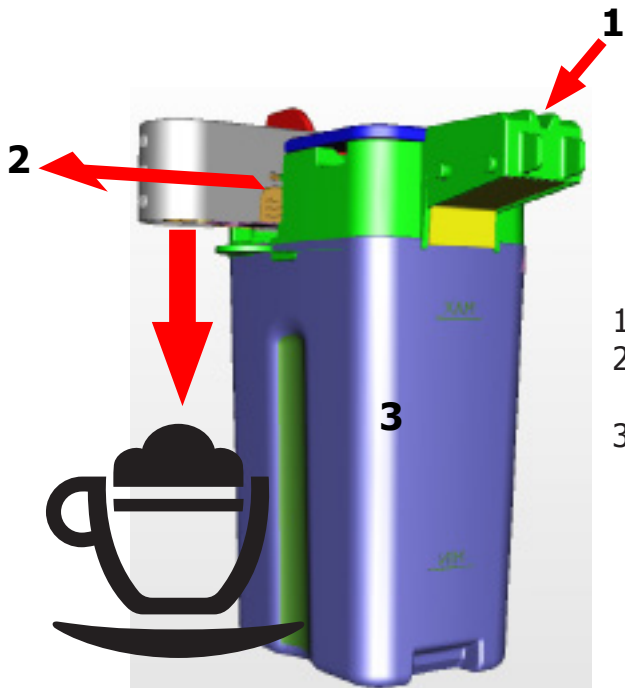

- 1) Steam input
- 2) Bring the cappuccino maker into dispensing position
- 3) Milk tank

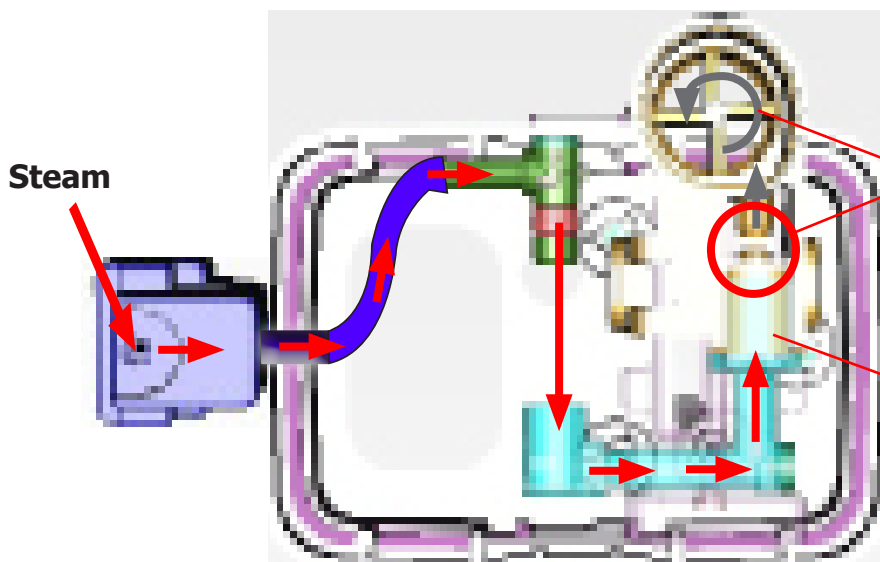

The milk is heated by the steam and taken towards the emulsion chamber where it is mixed with air and transformed into foam

The steam passes through the pipe creating a sucking effect that pulls the milk upwards

4.5. Coffee cycle

Main switch ON	START		STOP
Time			
Coffee grinder			Pulses (Dosage)
Heating	approx. 45 sec.		
Pump			Pump operation (flow meter pulses) in accordance with the amount of product selected.
Brewing unit gear motor			*
Status	Heating	Ready	Coffee cycle

Notes: * Only with Pre-brewing



Single microswitch gear motor

Switching on

When the machine is switched on, the gear motor repositions itself as follows:

- It acts on microswitch 1 (see following chapter).
- The gear motor changes its rotation direction and moves upwards again by approx. 1-2 mm.
- The boiler begins to heat the water for approx. 45 sec., at full power, in order to reach the optimal temperature. The temperature will then remain at a constant level.

Coffee cycle

1. The coffee grinder starts the grinding process (controlled by pulses generated by a sensor).
2. The gear motor (brewing unit) moves to the brewing position.
3. Preliminary dispensing phase (short pump activity, short pause).
4. Product dispensing (the pump operation period is defined by the amount of product dispensed).
5. The gear motor moves to its home position (the dregs are expelled automatically).

4.6. Single microswitch

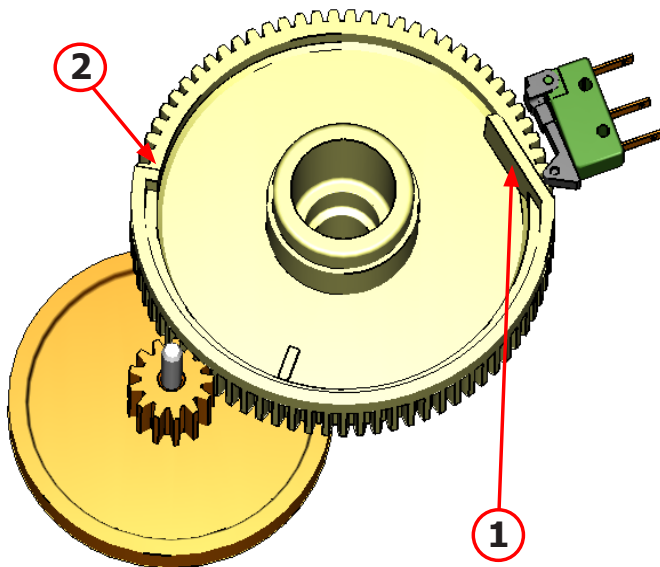

The gear motor is powered by a direct current motor that engages with the smaller double toothed wheel using a worm screw. The unit is mounted on the axle of the large gear wheel and when a coffee is requested, it moves from the standby position to the dispensing position, and then back to the standby position again.

- **Standby position: 1**

- **Dispensing position: 2**

4.7. Temperature sensor (adjustment)

Temp. (°C)	R nom (kΩ)	ΔR (+/- %)
20	61.465	8.6
50	17.599	5.9
75	7.214	4.1
80	6.121	3.7
85	5.213	3.4
90	4.459	3.1
100	3.3	2.5
125	1.653	3.9
150	0.893	5.1

An NTC is used as a temperature sensor; in the event of overheating this reduces boiler element power consumption.

The electronic system detects the current boiler temperature from the drop in voltage of the sensor and adjusts it accordingly.

Heating element values and corresponding temperatures: see table.

4.8. Coffee grinder

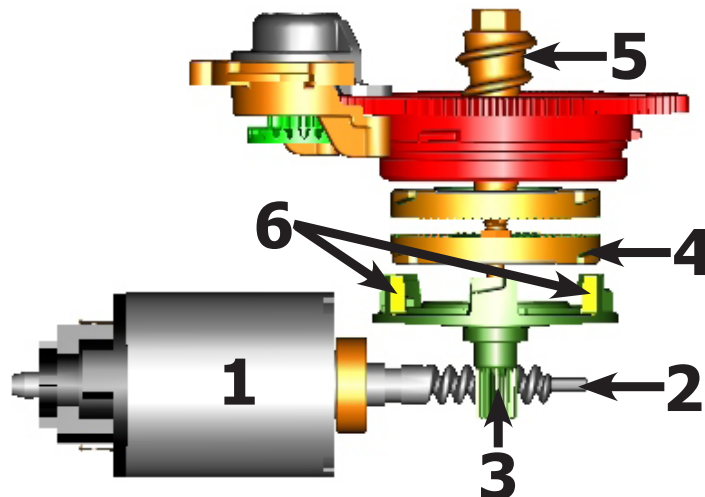

The coffee grinder is driven by a direct current motor (1) using a worm screw helicoidal wheel transmission (2).

The worm screw (2) drives a plastic gear wheel (3), which turns the lower grinder (4) and the increment pin (5)

There are two magnets (6) in the gear wheel; at every rotation these induce two pulses to a Hall sensor, which in turn transmits them to the electronic system.

4.9. Low bean level detection, dose quantity adjustment, coffee grinder blocked

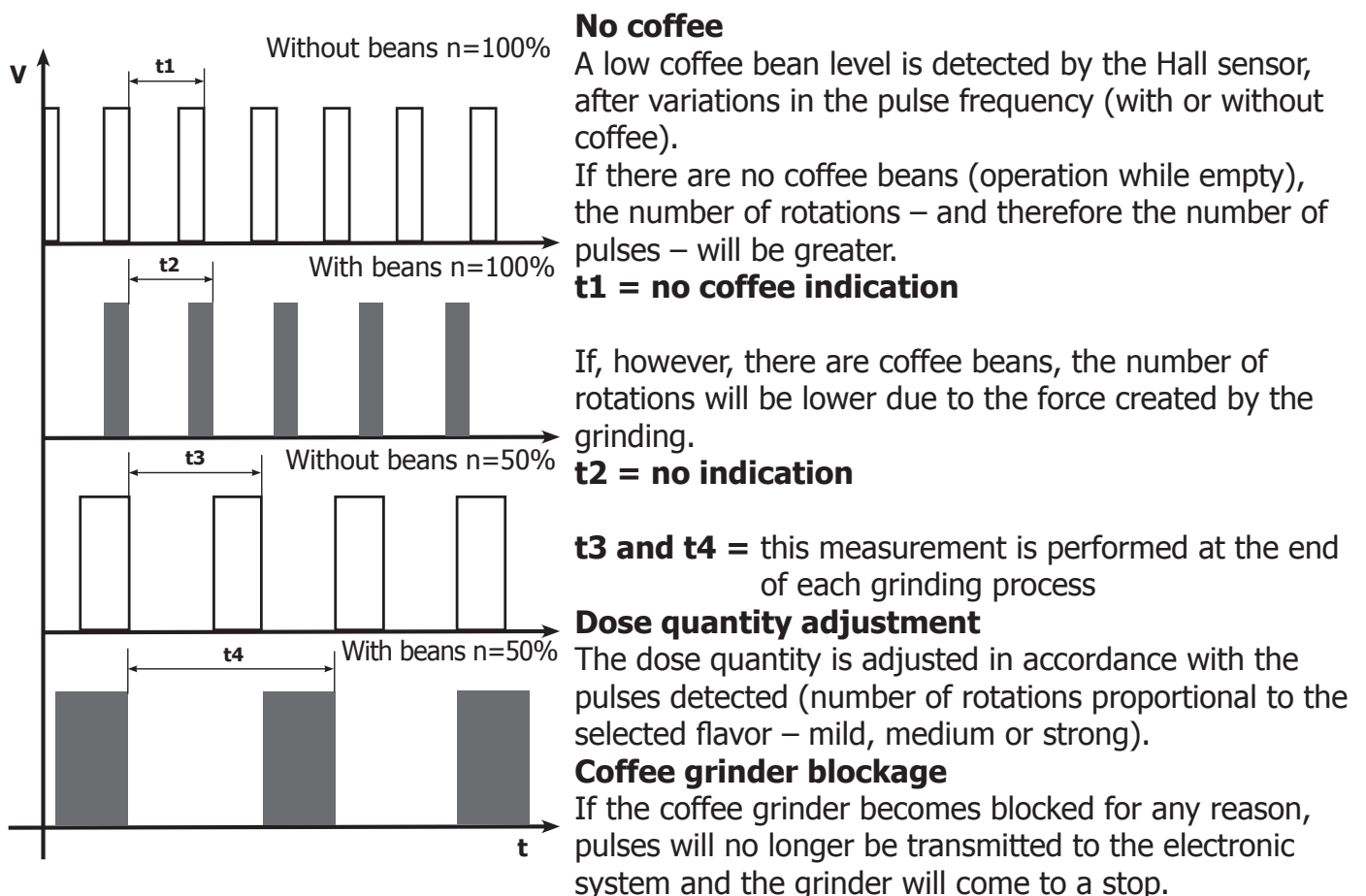

4.10. Dose self-learning (SAS)

The aim of this function is to automatically regulate the average dose of ground coffee (SELF-LEARNING); this takes place with an algorithm based on the following values and setting by the user:

1. Number of coffee grinder pulses during the grinding cycle.
2. Max. average value of the power consumed by the gear motor during the coffee brewing cycle.
3. Aroma selected by the user.

The algorithm compares the maximum average value of the power consumed by the gear motor with the value listed in the table for the selected aroma, in order to calculate the new grinding pulse value for the next coffee produced.

If the power consumption value is less than the minimum current value, the grinding pulses will be increased by 2.

If the power consumption value is greater than the maximum current value, the grinding pulses will be decreased by 4.

If the power consumption value falls within the "over-torque" interval, the product will be dispensed and the grinding pulses will be decreased by 10.

If the power consumption value falls within the "abort cycle" interval, the dreg will be expelled and the grinding pulses will be decreased by 10.

If the "pre-ground" flavour is selected by the user, no modification will be made.

This guarantees that, regardless of the coffee type used, the grinding level setting and the wear on the grinders, the ground coffee dose always remains constant.

			DOSE ADJUSTMENT (NUMBER OF GRINDER IMPULSES) TO APPLY TO MED AROMA						
			3 levels	5 levels	+2	0	-4	-10	-10 and CYCLE ABORTED
Aroma of the grinded product	A	Light	Very Light	MAX_CURRENT_mA <150mA	<=150mA MAX_CURRENT_mA <=250mA	MAX_CURRENT_mA >250mA	MAX_CURRENT_mA >800mA	MAX_CURRENT_mA >1000mA	
		B Med	Light	Med	MAX_CURRENT_mA <250mA	<=250mA MAX_CURRENT_mA <=350mA	MAX_CURRENT_mA >350mA	MAX_CURRENT_mA >800mA	MAX_CURRENT_mA >1000mA
	C Strong		Strong	Very Strong	MAX_CURRENT_mA <350mA	<=350mA MAX_CURRENT_mA <=500mA	MAX_CURRENT_mA >500mA	MAX_CURRENT_mA >800mA	MAX_CURRENT_mA >1000mA

Important:

For perfect operation, machine adjustment should take place in the area of the fields highlighted in green (A, B, C). When the type or brand of coffee is changed, there may be variations in the size of the beans and their stickiness or roasting level. This leads to variations in power consumption (mA), with resulting excessive or insufficient doses (until the necessary adjustments have been made to compensate for this change).

Caution: In the case of excessive dosage, powder may be expelled into the dreg drawer. This is not a fault, but can occur during preliminary operation or after a service.

4.11. Water level detection (water tank)

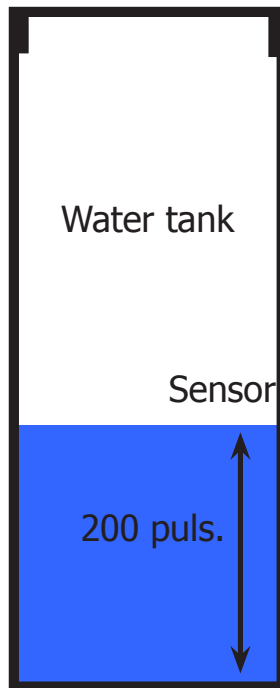

“Water low” message (water reserve)

Function:

The water level is monitored by a capacitive sensor, located one third of the way up the water tank wall.

If the electronics assembly detects, by means of the sensor, that the amount of water in the tank has dropped below the above mentioned level, a water reserve remains available for the dispensing process underway (this will cover 200 flow meter pulses).

The product dispensing process will then come to an end.

If a dispensing cycle ends after the sensor has been triggered (in the reserve) then the display “Water low” continues to be displayed during the following dispensing cycle.

4.12. Descaling request

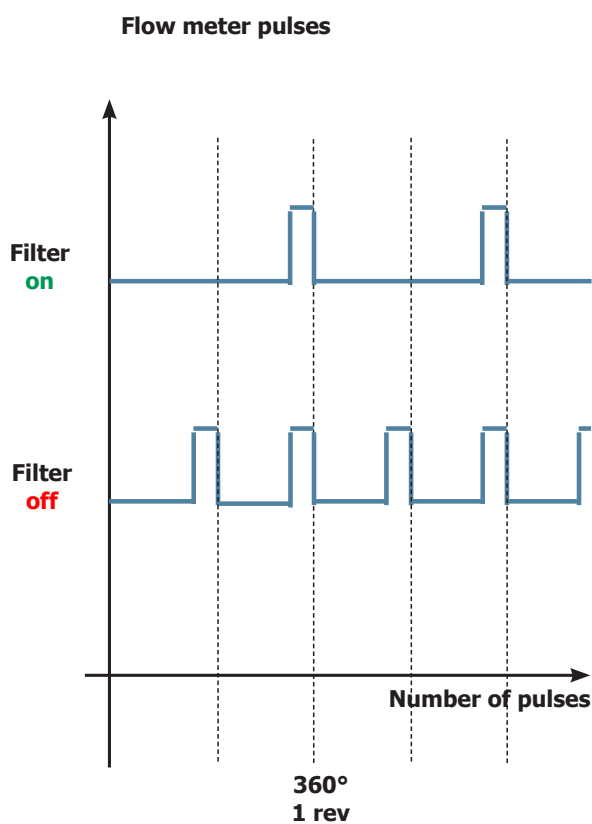

“Descaling” – message with water filter inserted

(appliances with display only)

The water hardness is set on the basis of the regional water hardness analysis (1, 2, 3, 4).

Filter off:

If the function is turned off the electronics assembly monitors the flow meter pulses, recording one pulse each turn.

Filter on:

If the function is turned on the electronics assembly monitors the flow meter pulses, recording one pulse every two turns.

“Change water filter” message

The electronics assembly uses the flow meter impulses to keep track of the amount of water which has flowed through; after the specified amount (set in accordance with the water hardness level), the “Replace filter” message appears.

4.13. Water filter

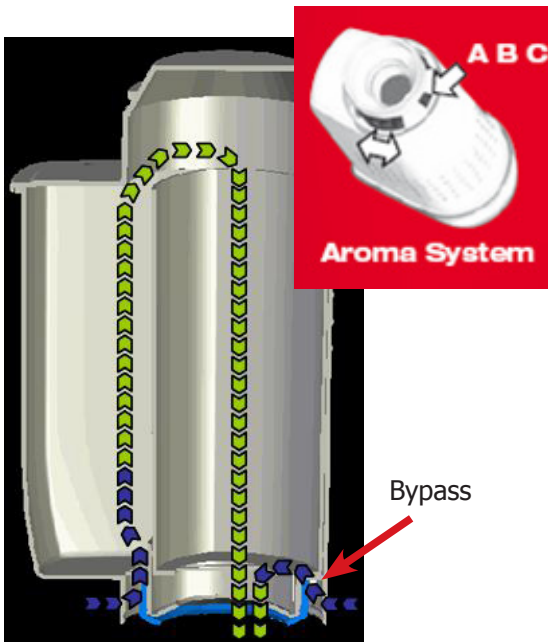
**Function:**

- Reduced limescale deposits which take longer to form.
- Improved water quality.
- Improved taste due to the ideal water hardness.

Life span / descaling performance:

- - 10 ° dH
- 60 litres
- 2 months

To achieve the best possible operating mode consistency over the total life span, the water is channelled using a 3-stage bypass (A, B, C) depending on the degree of hardness. See small image.



CHAPTER 5

TROUBLESHOOTING

5.1.1. Minuto Cappuccino test mode

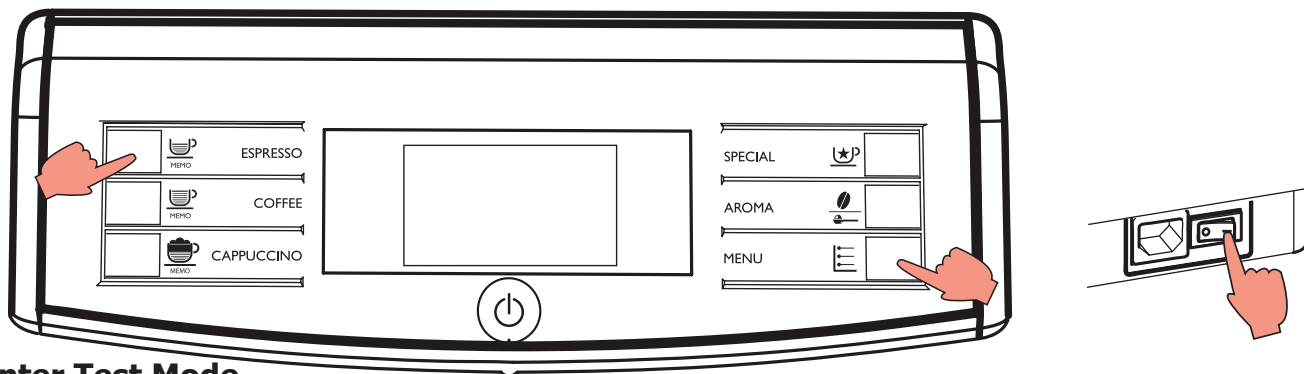

To enter Test Mode

The machine enters Test Mode by holding pressed together Espresso and Menu buttons, while switching on the machine by means of the main switch on the backside of the CA. Once entered in Test Mode, the display shows the firmware version.

The Test Mode is organized into **5 different pages**:

Page 0: The display shows:

- Firmware version.
- Type.
- Main supply voltage
- Main supply frequency (50 or 60 Hz).

Page 1: Keyboard and display's colour test:

- Espresso button
- Coffee button
- Cappuccino button
- Special button
- Menu button
- Aroma button
- Stand-by button
- Backlight colors

Page 2: Input signals test:

- Water level sensor
- Microswitch door closed/opened
- Microswitch presence of the Brew Unit
- Lever position on Espresso
- Lever position on Drip

Page 3: Low voltage loads test:

- Brew Unit movement upward and downward (24V DC)

Page 4: High/Low voltage loads test (Pump, E.Valve) :

- Pump (120-230V AC)
- Electro Valve 1 (24Vdc) (The door must be closed !!)
- Electro Valve 2 (24Vdc) (The door must be closed !!)

Page 5: High voltage loads test (Heater , Grinder) :

- Heater (120-230V AC)
- Grinder (170-320V DC)

The user can change the page by pressing the **STAND-BY** button.
 Page 0 is accessible only entering Test Mode from PowerOFF.
 At the start up all loads are turned off.

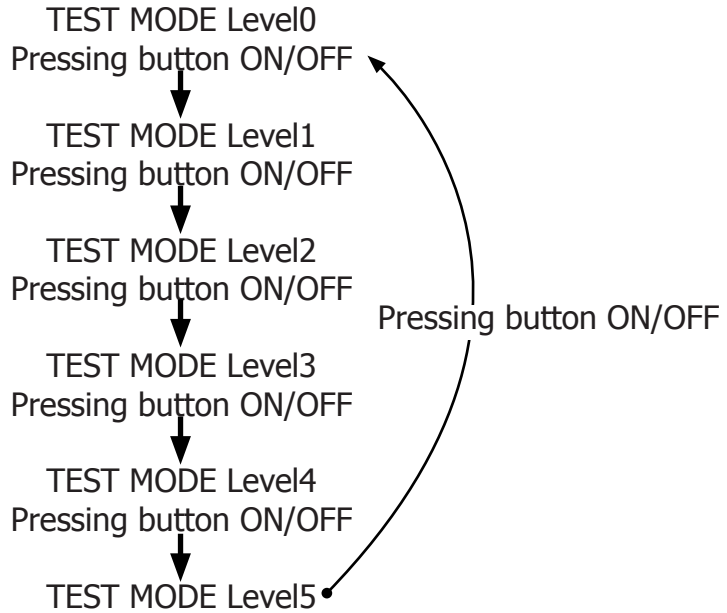

Firmware Software version



Firmware version on the display.
 The machine model is shown (TOP).
 The voltage of the main supply "230V/120V"
 The frequency of the main supply is shown (50 or 60 Hz)

ERROR: If machine model is different from TOP, change the interface.

Press STAND_BY " ⏻ " to move to the next screen

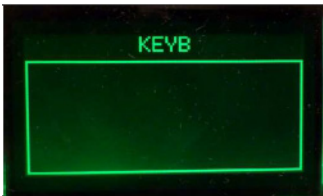

The machine passes to the Page 1 (KEYBOARD)
ERROR: The page does not change; Check the interface board and the flat cable (JP21)



Press buttons from 1 to 7

Only when a button is pressed a 0 appears on the relative position of button pressed.

In the middle of display appears the name of the button pressed. Pressing buttons on the left the backlight color changes from GREEN to YELLOW.

Pressing button on the right the backlight color changes from GREEN to RED.

When a button is pressed, also the Stand-By led (RED) turn ON.

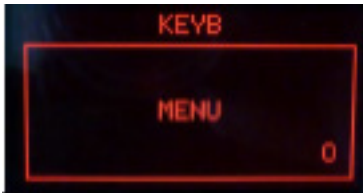

Note: Press button STANDBY as the last once, since it makes change the test page.

Note: If 2 or more buttons are pressed the name that appears on display could be wrong.

ERROR: If nothing appears on display; check the interface board and the flat cable (JP21).

ERROR: If during the movement the backlight remain green check the wiring (JP1) from the interface board and the display.

ERROR: The name displayed is wrong; check the position of jumper in interface. It must be the same of machine model:

- Jumper on JP5 for Focus machine model
- Jumper on JP6 for Class machine model

Press STAND_BY "  " to move to the next screen



The machine passes to the level 2 (INPUTS)

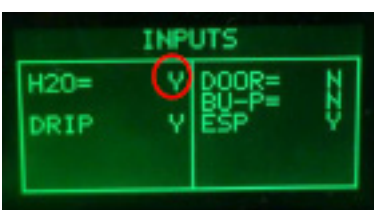

Insert a full Water Tank

The indication H2O changes from "N" to "Y".

Note: the switching from "N" to "Y" requires about 1-2 seconds.

ERROR: The indication TANK-H2O doesn't change; check the capacitive sensor (fixing) and the wiring (JP23)



Insert the BrewUnit

The indications BU-P changes from "N" to "Y".

Note: removing the BrewUnit the indication from "Y" to "N" requires about 2-3 seconds to switch.

ERROR: Check the BU presence Microswitch and the wiring (JP16).



Close the Door and Dreg Drawer

The indication DOOR change from "N" to "Y"

ERROR: The indication DOOR does not change; check the Microswitch for the door and the wiring (JP14).

Note: without the Dreg Drawer correctly inserted the DOOR indication cannot change!

Press STAND_BY "⏻" to move to the next screen

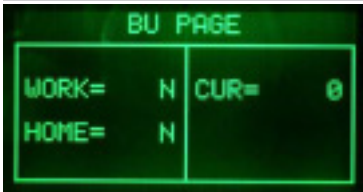

The machine passes to the Page 3 (BU PAGE)

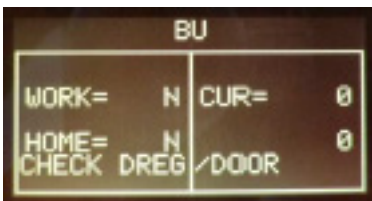

Press the ESPRESSO button to move the BU to Work

IMPORTANT NOTE: If the DREGDRAWER is not inserted or the DOOR is not closed the BU test cannot be performed. If these 2 inputs are not in the right position, a warning message will be shown and the display turns to yellow.

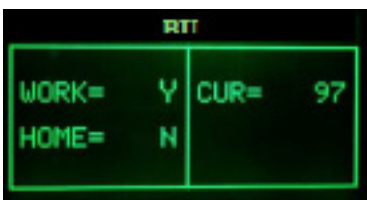

When the BU reaches the work position the indication WORK changes from "N" to "Y", the number of the current is minus than 200mA (without BU) or 300mA (with BU).



ERROR: The indication WORK doesn't change and remain "N", the display backlight changes from green to red; Check the work microswitch (broken?), the BU motor (blocked?) and the wiring (JP16).



ERROR: (Without BU) The absorbed current is more than 200mA, the display backlight changes from green to red; check the BU and the motor.

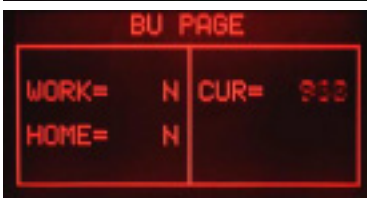

ERROR: (With BU) The absorbed current is more than 300mA, the display backlight changes from green to red; check the BU and the motor



Press the CAPPUCCINO button to move the BU to Home

When the BU reaches the home position the indication HOME changes from "N" to "Y", the number of the current is minus than 200mA (without BU) or 300mA (with BU).



ERROR: The indication HOME doesn't change and remain "N", the display backlight changes from green to red; Check the work microswitch (is broken), the BU motor (is blocked) and the wiring (JP16).



ERROR: (Without BU) The absorbed current is higher than 200mA, the display backlight changes from green to red; check the BU and the motor.



ERROR: (With BU)The absorbed current is higher than 300mA, the display backlight changes from green to red; check the BU and the motor

Press STAND_BY "⏻" to move to the next screen



The machine passes to the Page 4 (EV - PUMP)



Press the ESPRESSO button to open the Electro Valve 1
IMPORTANT NOTE: If the DREGDRAWER is not inserted or the DOOR is not closed the EV test cannot be performed. If these 2 inputs are not in the right position, a warning message will be shown and the display turns to yellow.



It is possible to hear the "click" from Electro Valve. The indication beside the EV1 changes from "OFF" to "ON".



Press the COFFEE button to open the Electro Valve 2

It is possible to hear the "click" from Electro Valve. The indication beside the EV2 changes from "OFF" to "ON".



Press the STEAM button to switch on the pump

The water goes out from the pipe and the indication IMP shows increasing numbers. The indication L/H must be within the range 10-18.



ERROR: The display backlight changes from green to red and the impulse remains 0; If water comes out the pipe: check the wiring from the flowmeter to the CPU/POWER board (JP5). If no water comes out the pipe: check the pump and the wiring from the pump to the CPU/POWER board (JP24).



ERROR: The L/H is zero or very low; the Electro Valve does not open. Check the wiring from the Electro Valve to the CPU/POWER board (JP3) and the Electro Valve.

Press STAND_BY "⏻" to move to the next screen



The machine passes to the level 5 (Heater-Grinder)



Press the **STEAM** button to switch on the grinder

The grinder rotates and in the indication GRINDER the number increasing up to 40. The other numbers inside the GRINDER box are not important for this test.



ERROR: The number remains 0 or the grinder does not run, the display backlight changes from green to red; check the Hall sensor board of the Grinder, the Grinder, the wiring from the Hall sensor board to the CPU/POWER board (JP2) and the wiring from the Grinder to the CPU/POWER board (JP8)

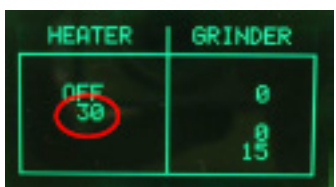

Check the temperature

The number shows the heater temperature .



ERROR: In the indication HEATER appears "SHORT", the NTC temperature-sensor is shorted, the display backlight changes from green to red; check the wiring from the NTC temperature-sensor to the CPU/POWER board (JP13).



ERROR: In the indication HEATER appears "OPEN", the NTC temperature-sensor is detached or broken, the display backlight changes from green to red; check the wiring from the NTC temperature-sensor to the CPU/POWER board (JP13).



Press the **ESPRESSO** button to switch on the Heater

The absorbed current (Amperometer on the main supply) is OK, the indication HEATER changes from "OFF" to "ON" and the temperature starts increasing.

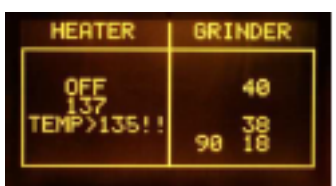

If temperature is over 135°C, the backlight change from GREEN to YELLOW. This is a ALERT message to avoid heating the HEATER element over dangerous temperature.

ERROR: the absorbed current is KO or the temperature does not increase; check the wiring from the heater to the CPU/POWER board (JP19) and the wiring of the NTC temperature-sensor (JP13).

5.1.2. SteamOut

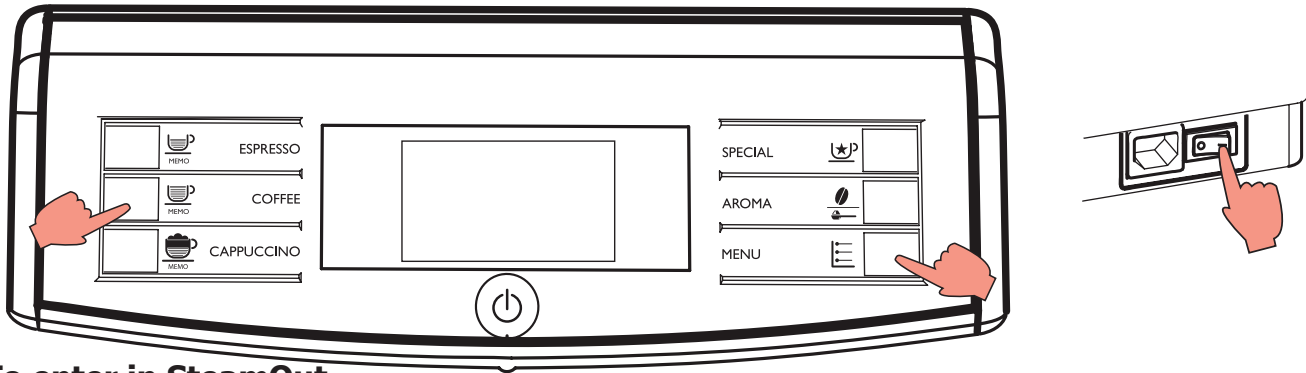

To enter in SteamOut

The machine enters SteamOut mode by holding pressed together the COFFEE button and the MENU button while switching on the machine



Once entered the Steam Out mode the display shows the "STEAM OUT" indication. Buttons can be released



IMPORTANT NOTE: to execute the Steam-Out procedure the DREGDRAWER must be in place and the DOOR must be closed. If these 2 conditions are not respected a warning message is shown on the display and the Steam-Out is interrupted.

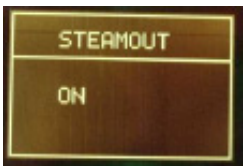

The machine starts the Steam Out and the display change the backlight (yellow) and appears the indication "ON". While the Steam Out runs the Electrovalve is opened and water comes out the Water/Steam pipe.



When the Steam Out is complete the message "COMPLETE" is shown on the Display. The Electrovalve automatically closes and the machine can be switched off.

When the Steam-Out is complete the following parameters are reset to their default values:

- Length Espresso product
- Length Coffee product
- Length Cappuccino (Coffee + Milk product)
- Length Milk product
- StandBy Time
- Count Coffee
- The request for Priming the Circuit at the first switch on is set.
- Brewing Unit Empty
- Aroma
- Aroma Impulses
- Filter Presence
- Filter Pulses
- Dynamic threshold
- History of grindings for Beans Presence detection
- Filter Presence

5.2.1. Minuto Cappuccino test mode for USA

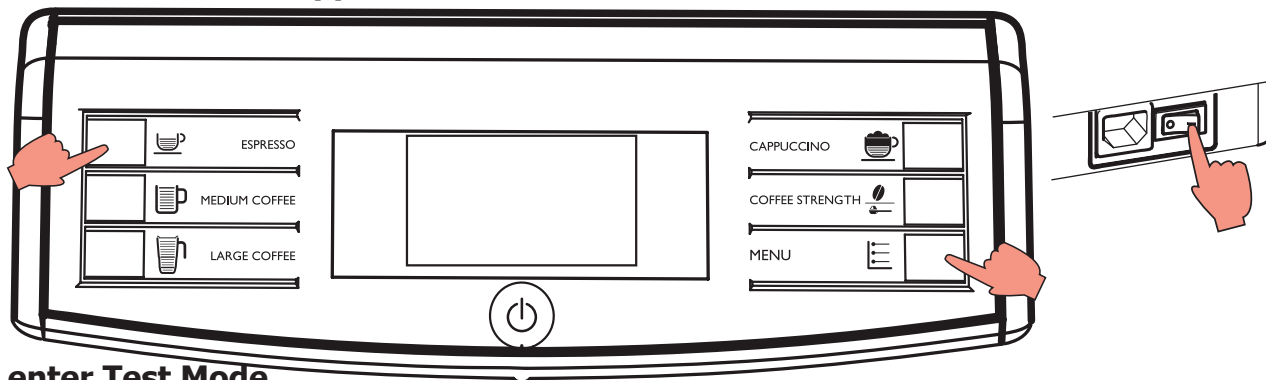

To enter Test Mode

The machine enters Test Mode by holding pressed together Espresso and Menu buttons, while switching on the machine by means of the main switch on the backside of the CA. Once entered in Test Mode, the display shows the firmware version.

The Test Mode is organized into **5 different pages**:

Page 0: The display shows:

- Firmware version.
- Type.
- Main supply voltage
- Main supply frequency (50 or 60 Hz).

Page 1: Keyboard and display's colour test:

- Espresso button
- Medium Coffee button
- Long Coffee button
- Cappuccino button
- Aroma button
- Menu button
- Stand-by button
- Backlight colors

Page 2: Input signals test:

- Water level sensor
- Microswitch door closed/opened
- Coffee Beans cover presence
- Microswitch presence of the Brew Unit
- Lever position on Espresso
- Lever position on Drip

Page 3: Low voltage loads test:

- Brew Unit movement upward and downward (24V DC)

Page 4: High/Low voltage loads test (Pump, E.Valve) :

- Pump (AC voltage)
- Electro Valve (24Vdc) (The door must be closed !!)

Page 5: High voltage loads test (Heater , Grinder) :

- Heater (120-230V AC)
- Grinder (170-320V DC)

The user can change the page by pressing the **STAND-BY** button.
 Page 0 is accessible only entering Test Mode from PowerOFF.
 At the start up all loads are turned off.

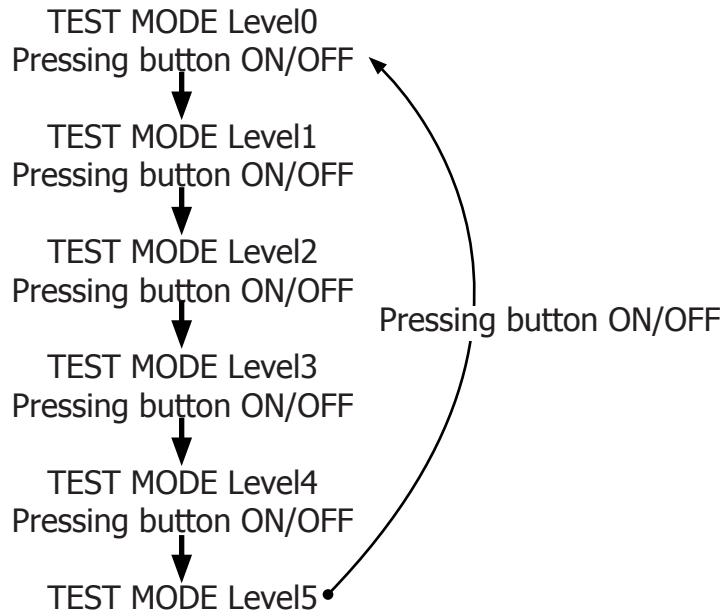

Firmware Software version



Firmware version on the display.
 The machine model is shown (TOP).
 The voltage of the main supply "230V/120V"
 The frequency of the main supply is shown (50 or 60 Hz)

ERROR: If machine model is different from TOP, change the interface.

Press STAND_BY " ⏻ " to move to the next screen

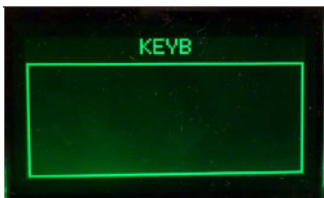

The machine passes to the Page 1 (KEYBOARD)
ERROR: The page does not change; Check the interface board and the flat cable (JP21)



Press buttons from 1 to 7

Only when a button is pressed a 0 appears on the relative position of button pressed.

In the middle of display appears the name of the button pressed. Pressing buttons on the left the backlight color changes from GREEN to YELLOW.

Pressing button on the right the backlight color changes from GREEN to RED.

When a button is pressed, also the Stand-By led (RED) turn ON.

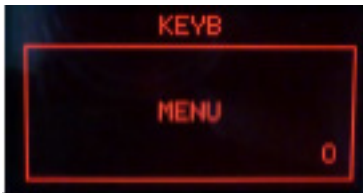

Note: Press button STANDBY as the last once, since it makes change the test page.

Note: If 2 or more buttons are pressed the name that appears on display could be wrong.

ERROR: If nothing appears on display; check the interface board and the flat cable (JP21).

ERROR: If during the movement the backlight remain green check the wiring (JP1) from the interface board and the display.

ERROR: The name displayed is wrong; check the position of jumper in interface. It must be the same of machine model:

- Jumper on JP5 for Focus machine model
- Jumper on JP6 for Class machine model

Press STAND_BY "  " to move to the next screen

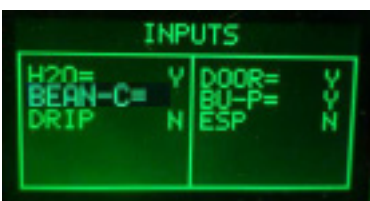

The machine passes to the level 2 (INPUTS)

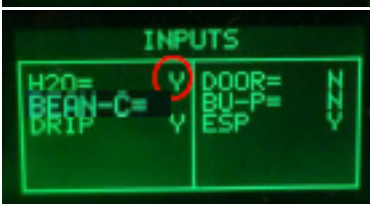

Insert a full Water Tank

The indication H2O changes from "N" to "Y".

Note: the switching from "N" to "Y" requires about 1-2 seconds.

ERROR: The indication TANK-H2O doesn't change; check the capacitive sensor (fixing) and the wiring (JP23)

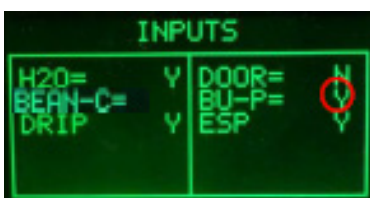

Insert the BrewUnit

The indications BU-P changes from "N" to "Y".

Note: removing the BrewUnit the indication from "Y" to "N" requires about 2-3 seconds to switch.

ERROR: Check the BU presence Microswitch and the wiring (JP16).

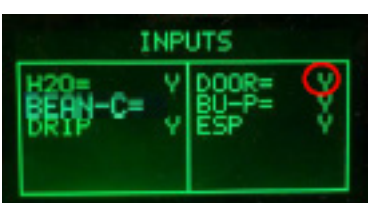

Close the Door and Dreg Drawer

The indication DOOR change from "N" to "Y"

ERROR: The indication DOOR does not change; check the Microswitch for the door and the wiring (JP14).

Note: without the Dreg Drawer correctly inserted the DOOR indication cannot change!

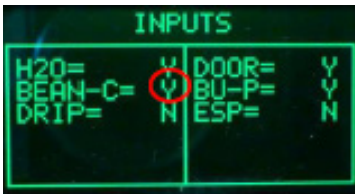

The indications BEAN-C changes from "N" to "Y".

ERROR: The indication BEAN-C does not change; check the reed for the cover and the wiring (JP25).

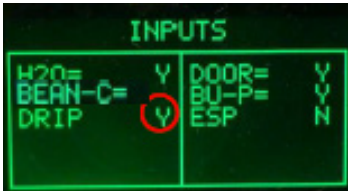

Move Pressure Lever in COFFEE position

The indications DRIP changes from "N" to "Y".



Move Pressure Lever in ESPRESSO position

The indication ESP change from "N" to "Y".

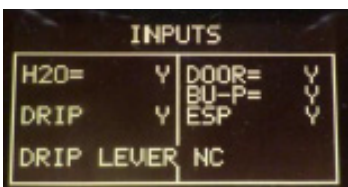

IMPORTANT NOTE: If the Pressure Lever is not inserted (on 120V version) a warning message will be shown and the display turns to yellow..

Check JP4 on interface board.

Press STAND_BY "  " to move to the next screen

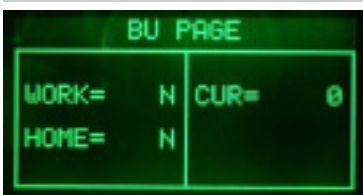

The machine passes to the Page 3 (BU PAGE)



Press the ESPRESSO button to move the BU to Work

IMPORTANT NOTE: If the DREGDRAWER is not inserted or the DOOR is not closed the BU test cannot be performed. If these 2 inputs are not in the right position, a warning message will be shown and the display turns to yellow.

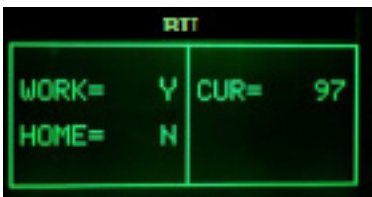

When the BU reaches the work position the indication WORK changes from "N" to "Y", the number of the current is minus than 200mA (without BU) or 300mA (with BU).



ERROR: The indication WORK doesn't change and remain "N", the display backlight changes from green to red; Check the work microswitch (broken?), the BU motor (blocked?) and the wiring (JP16).

Press STAND_BY "⏻" to move to the next screen



ERROR: (Without BU) The absorbed current is more than 200mA, the display backlight changes from green to red; check the BU and the motor.

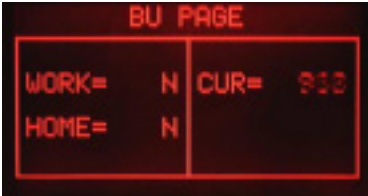

ERROR: (With BU) The absorbed current is more than 300mA, the display backlight changes from green to red; check the BU and the motor

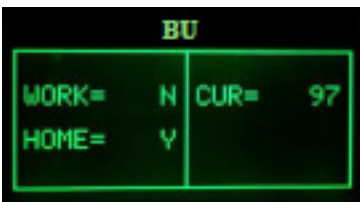

Press the LONG COFFEE button to move the BU to Home

When the BU reaches the home position the indication HOME changes from "N" to "Y", the number of the current is minus than 200mA (without BU) or 300mA (with BU).



ERROR: The indication HOME doesn't change and remain "N", the display backlight changes from green to red; Check the work microswitch (is broken), the BU motor (is blocked) and the wiring (JP16).



ERROR: (Without BU) The absorbed current is higher than 200mA, the display backlight changes from green to red; check the BU and the motor.



ERROR: (With BU) The absorbed current is higher than 300mA, the display backlight changes from green to red; check the BU and the motor

Press STAND_BY "⏻" to move to the next screen



The machine passes to the Page 4 (EV - PUMP)



Press the ESPRESSO button to open the Electro Valve 1

IMPORTANT NOTE: If the DREGDRAWER is not inserted or the DOOR is not closed the EV test cannot be performed. If these 2 inputs are not in the right position, a warning message will be shown and the display turns to yellow.



It is possible to hear the "click" from Electro Valve. The indication beside the EV1 changes from "OFF" to "ON".



Press the MEDIUM COFFEE button to open the Electro Valve 2
It is possible to hear the "click" from Electro Valve. The indication beside the EV2 changes from "OFF" to "ON".



Press the CAPPUCCINO button to switch on the pump
The water goes out from the pipe and the indication IMP shows increasing numbers. The indication L/H must be within the range 10-18.



ERROR: The display backlight changes from green to red and the impulse remains 0; If water comes out the pipe: check the wiring from the flowmeter to the CPU/POWER board (JP5). If no water comes out the pipe: check the pump and the wiring from the pump to the CPU/POWER board (JP24).



ERROR: The L/H is zero or very low; the Electro Valve does not open. Check the wiring from the Electro Valve to the CPU/POWER board (JP3) and the Electro Valve.

Press STAND_BY "  " to move to the next screen

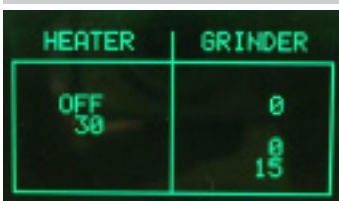

The machine passes to the level 5 (Heater-Grinder)

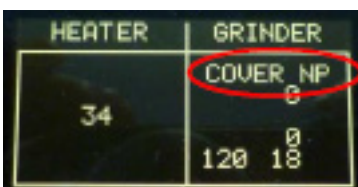

Press the CAPPUCCINO button to switch on the grinder
IMPORTANT NOTE: If the COFFEE BEANS Cover is not inserted the Grinder test cannot be performed in 120V. If this input is not in the right position, a warning message will be shown and the display turns to yellow.

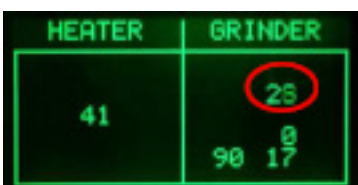

The grinder rotates and in the indication GRINDER the number increasing up to 40. The other numbers inside the GRINDER box are not important for this test.



ERROR: The number remains 0 or the grinder does not run, the display backlight changes from green to red; check the Hall sensor board of the Grinder, the Grinder, the wiring from the Hall sensor board to the CPU/POWER board (JP2) and the wiring from the Grinder to the CPU/POWER board (JP8)

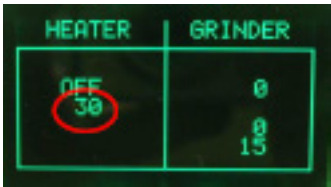

Check the temperature

The number shows the heater temperature .



ERROR: In the indication HEATER appears "SHORT", the NTC temperature-sensor is shorted, the display backlight changes from green to red; check the wiring from the NTC temperature-sensor to the CPU/POWER board (JP13).



ERROR: In the indication HEATER appears "OPEN", the NTC temperature-sensor is detached or broken, the display backlight changes from green to red; check the wiring from the NTC temperature-sensor to the CPU/POWER board (JP13).

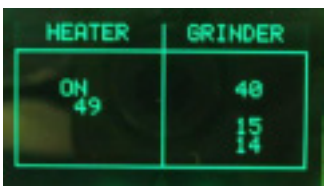

Press the ESPRESSO button to switch on the Heater

The absorbed current (Amperometer on the main supply) is OK, the indication HEATER changes from "OFF" to "ON" and the temperature starts increasing.



If temperature is over 100°C, the backlight change from GREEN to YELLOW. This is a ALERT message to avoid heating the HEATER element over dangerous temperature.

ERROR: the absorbed current is KO or the temperature does not increase; check the wiring from the heater to the CPU/POWER board (JP19) and the wiring of the NTC temperature-sensor (JP13).

5.2.2. SteamOut

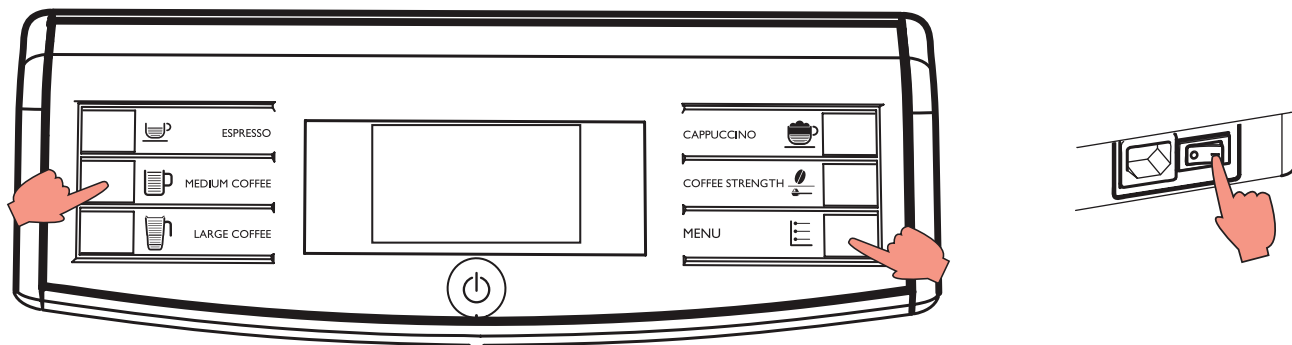

To enter in SteamOut

The machine enters SteamOut mode by holding pressed together the MEDIUM COFFEE button and the MENU button while switching on the machine

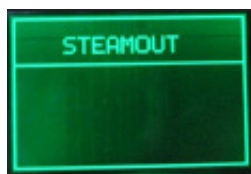

Once entered the Steam Out mode the display shows the "STEAM OUT" indication. Buttons can be released



IMPORTANT NOTE: to execute the Steam-Out procedure the DREGDRAWER must be in place and the DOOR must be closed.

If these 2 conditions are not respected a warning message is shown on the display and the Steam-Out is interrupted.

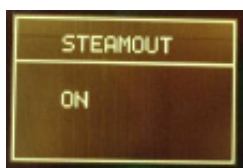

The machine starts the Steam Out and the display change the backlight (yellow) and appears the indication "ON".

While the Steam Out runs the Electrovalve is opened and water comes out the Water/Steam pipe.

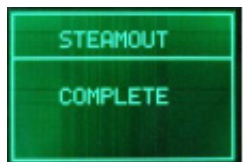

When the Steam Out is complete the message "COMPLETE" is shown on the Display. The Electrovalve automatically closes and the machine can be switched off.

When the Steam-Out is complete the following parameters are reset to their default values:

- Length Espresso product
- Length Medium Coffee product
- Length Large coffee product
- Length Milk product
- StandBy Time
- Count Coffee
- The request for Priming the Circuit at the first switch on is set.
- Brewing Unit Empty
- Aroma
- Aroma Impulses
- Filter Presence
- Filter Pulses
- Dynamic threshold
- History of grindings for Beans Presence detection
- Filter Presence

5.3.1. Minuto Focus/Class test mode

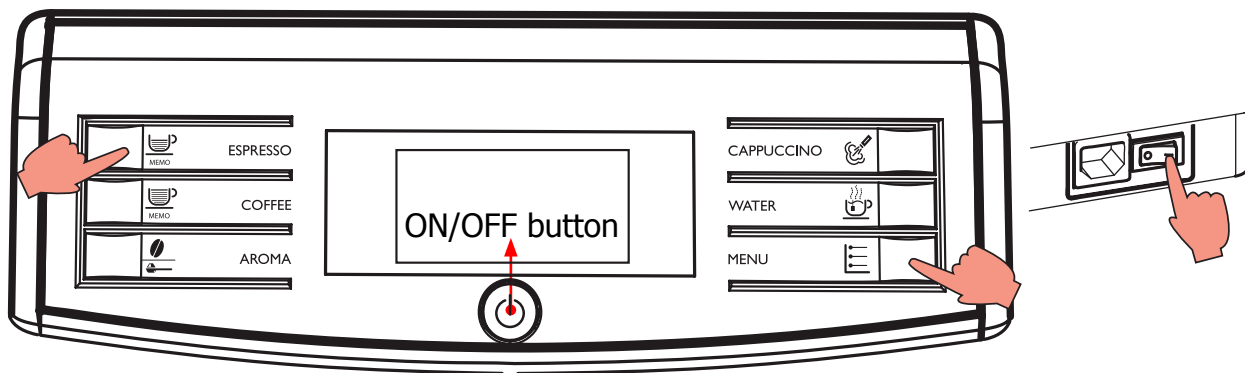

To enter Test Mode

The machine enters Test Mode by holding pressed together Espresso and Menu buttons (or Calc-Clean button in Focus version) while switching on the machine by means of the main switch on the backside of the CA. Once entered in Test Mode, the display shows the firmware version.

The Test Mode is organized into **5 different pages** :

Page 0: The display shows:

- Firmware version.
- CLASS or FOCUS type.
- "120" if the machine is a 120V model.
- Main supply frequency (50 or 60 Hz).

Page 1: Keyboard and display's colour test:

- Espresso button
- Cafè Crème button
- Steam button
- Water button
- Menu button (or CalcClean button in FOCUS version)
- Aroma button
- Stand-by button
- Backlight colors

Page 2: Input signals test:

- Water level sensor
- Microswitch door closed/opened
- Microswitch presence of the Brew Unit
- Lever position on Espresso
- Lever position on Drip

Page 3: Low voltage loads test:

- Brew Unit movement upward and downward (24V DC)

Page 4: High/Low voltage loads test (Pump, E.Valve) :

- Pump (120-230V AC)
- Electro Valve (24Vdc) (The door must be closed !!)

Page 5: High voltage loads test (Heater , Grinder) :

- Heater (120-230V AC)
- Grinder (170-320V DC)

Firmware Software version



Firmware version on the display.

The machine model is shown (FOCUS or CLASS).

The voltage of the main supply "230V/120V"

The frequency of the main supply is shown (50 or 60 Hz)

ERROR: If machine model is different from CLASS or FOCUS, change the interface.

Press STAND_BY "  " to move to the next screen

Operational check – keys



Start condition

Only when a button is pressed a 0 appears on the relative position of button pressed.

In the middle of display appears the name of the button pressed.

Pressing buttons on the left the backlight color changes from GREEN to YELLOW.

Pressing button on the right the backlight color changes from GREEN to RED.

When a button is pressed, also the Stand-By led (RED) turn ON.

Note: Press button STANDBY as the last once, since it makes change the test page.

Note: If 2 or more buttons are pressed the name that appears on display could be wrong.

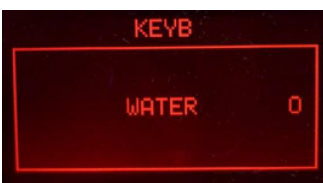

ERROR:

If nothing appears on display; check the interface board and the flat cable (JP21).

If during the movement the backlight remain green check the wiring (JP1) from the interface board and the display.

The name displayed is wrong; check the position of jumper in interface. It must be the same of machine model:

- Jumper on JP5 for Focus machine model
- Jumper on JP6 for Class machine model

Press STAND_BY "  " to move to the next screen

Operational check microswitches and sensors



Start condition

Insert a full Water Tank

The indication H2O changes from "N" to "Y".

NOTE: the switching from "N" to "Y" requires about 1-2 seconds.

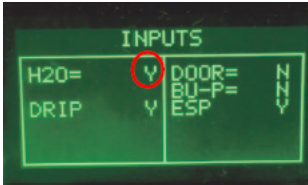

ERROR: The indication TANK-H2O doesn't change; check the capacitive sensor (fixing) and the wiring (JP23)

Insert the BrewUnit

The indications BU-P changes from "N" to "Y".

NOTE: removing the BrewUnit the indication from "Y" to "N" requires about 2-3 seconds to switch.

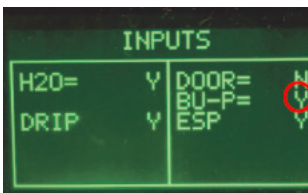

ERROR: Check the BU presence Microswitch and the wiring (JP16).

Close the Door and Dreg Drawer

The indication DOOR change from "N" to "Y"

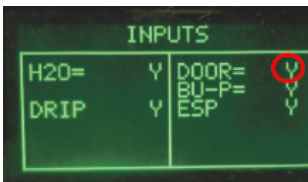

ERROR: The indication DOOR does not change; check the Microswitch for the door and the wiring (JP14). NOTE: without the Dreg Drawer correctly inserted the DOOR indication cannot change !

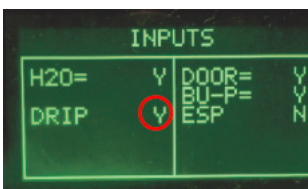

Move Pressure Lever in DRIP position (120V only)

The indications DRIP changes from "N" to "Y". (120V only)

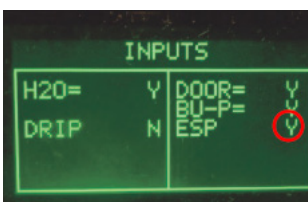

Move Pressure Lever in ESPRESSO position (120V only)

The indication ESP change from "N" to "Y". (120V only)

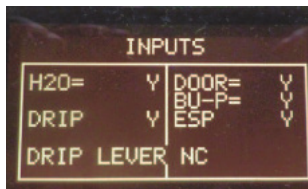

IMPORTANT NOTE: If the Pressure Lever is not inserted (on 120V version) a warning message will be shown and the display turns to yellow..

Check JP4 on interface board.

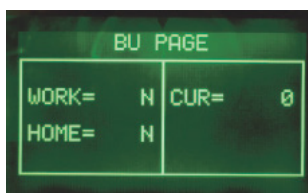

Press the STAND-BY button

The machine passes to the Page 3 (BU PAGE)

Press STAND_BY "  " to move to the next screen

Operational check – brewing unit

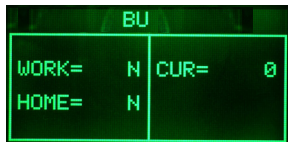

Start condition



Press the ESPRESSO button to move the BU to Work

IMPORTANT NOTE: If the DREGDRAWER is not inserted or the DOOR is not closed the BU test cannot be performed. If these 2 inputs are not in the right position, a warning message will be shown and the display turns to yellow..

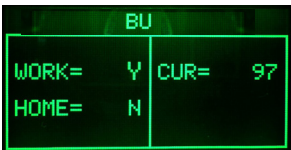

When the BU reaches the work position the indication **WORK** changes from "N" to "Y", the number of the current is minus than 200mA (without BU) or 300mA (with BU).

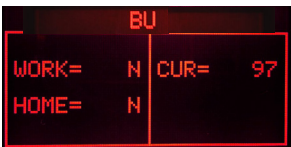

ERROR: The indication **WORK** doesn't change and remain "N", the display backlight changes from green to red; Check the work microswitch (broken?), the BU motor (blocked?) and the wiring (JP16)

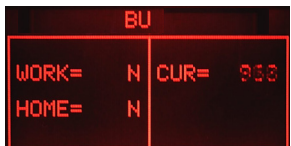

ERROR: (Without BU) The absorbed current is more than 200mA, the display backlight changes from green to red; check the BU and the motor.

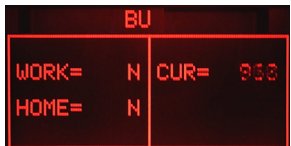

ERROR: (With BU) The absorbed current is more than 300mA, the display backlight changes from green to red; check the BU and the motor

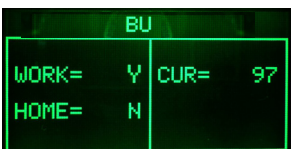

Press the AROMA button to move the BU to Home

When the BU reaches the home position the indication **HOME** changes from "N" to "Y", the number of the current is minus than 200mA (without BU) or 300mA (with BU).

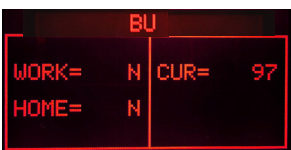

ERROR: The indication **HOME** doesn't change and remain "N", the display backlight changes from green to red; Check the work microswitch (is broken), the BU motor (is blocked) and the wiring (JP16).



ERROR: (Without BU) The absorbed current is higher than 200mA, the display backlight changes from green to red; check the BU and the motor.

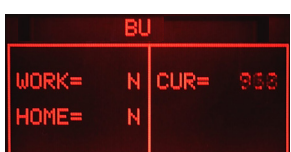

ERROR: (With BU) The absorbed current is higher than 300mA, the display backlight changes from green to red; check the BU and the motor

Press STAND_BY "  " to move to the next screen

Operational check - solenoid valves and pump

EU		PUMP	
EV1	OFF	IMP=	0
		L/H=	0

Start condition

EU		PUMP	
EV1	OFF	IMP=	0
CHECK DREG		L/H=	0
		DOOR	

Press the ESPRESSO button to open the Electro Valve

IMPORTANT NOTE: If the DREGDRAWER is not inserted or the DOOR is not closed the EV test cannot be performed. If these 2 inputs are not in the right position, a warning message will be shown and the display turns to yellow.

EU		PUMP	
EV1	ON	IMP=	0
		L/H=	0

It is possible to hear the "click" from Electro Valve. The indication beside the **EV1** changes from "OFF" to "ON".

EU		PUMP	
EV1	ON	IMP=	69
		L/H=	13

Press the STEAM button to switch on the pump

The water goes out from the pipe and the indication **IMP** shows increasing numbers. The indication L/H must be within the range 10-18.

EU		PUMP	
EV1	ON	IMP=	0
		L/H=	0

ERROR: The display backlight changes from green to red and the impulse remains 0; If water comes out the pipe: check the wiring from the flowmeter to the CPU/POWER board (JP5). If no water comes out the pipe: check the pump and the wiring from the pump to the CPU/POWER board (JP24).

EU		PUMP	
EV1	ON	IMP=	69
		L/H=	0

ERROR: The L/H is zero or very low; the Electro Valve does not open. Check the wiring from the Electro Valve to the CPU/POWER board (JP3) and the Electro Valve.

Press STAND_BY "  " to move to the next screen

Operational check - coffee grinder and boiler

HEATER		GRINDER	
OFF	30		0
			0
			15

Initial status

HEATER		GRINDER	
41		28	0
		90	17

Press the STEAM button to switch on the grinder

The grinder rotates and in the indication GRINDER the number increasing up to 40. The other numbers inside the GRINDER box are not important for this test.

HEATER		GRINDER	
OFF	30	0	0
			15

ERROR: The number remains 0 or the grinder does not run, the display backlight changes from green to red; check the Hall sensor board of the Grinder, the Grinder, the wiring from the Hall sensor board to the CPU/POWER board (JP2) and the wiring from the Grinder to the CPU/POWER board (JP8)

HEATER	GRINDER
OFF 30	0 0 15

Check the temperature

The number shows the heater temperature .

HEATER	GRINDER
75 SHORT	0 0 90 18

ERROR: In the indication HEATER appears "SHORT", the NTC temperature-sensor is shorted, the display backlight changes from green to red; check the wiring from the NTC temperature-sensor to the CPU/POWER board (JP13).

HEATER	GRINDER
127 OPEN	40 38 90 18

ERROR: In the indication HEATER appears "OPEN", the NTC temperature-sensor is detached or broken, the display backlight changes from green to red; check the wiring from the NTC temperature-sensor to the CPU/POWER board (JP13).

HEATER	GRINDER
ON 49	40 15 14

Press the ESPRESSO button to switch on the Heater

The absorbed current (Amperometer on the main supply) is OK, the indication HEATER changes from "OFF" to "ON" and the temperature starts increasing.

HEATER	GRINDER
OFF 137 TEMP>135!!	40 38 90 18

If temperature is over 135°C, the backlight change from GREEN to YELLOW. This is a ALERT message to avoid heating the HEATER element over dangerous temperature.

ERROR: the absorbed current is KO or the temperature does not increase; check the wiring from the heater to the CPU/POWER board (JP19) and the wiring of the NTC temperature-sensor (JP13).

5.3.2. SteamOut

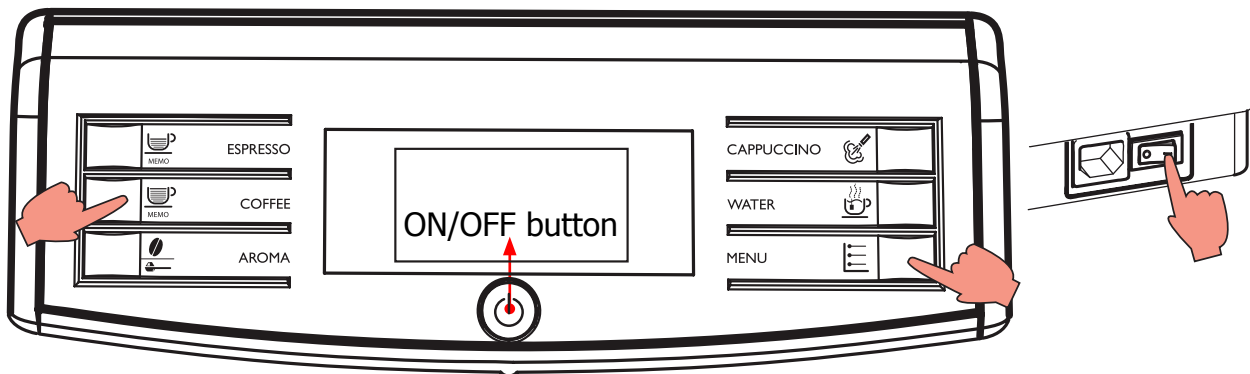

To enter in SteamOut

The machine enters SteamOut mode by holding pressed together the CAFE' CREME button and the MENU/CALC CLEAN button while switching on the machine.



Once entered the Steam Out mode the display shows the "STEAM OUT" indication. Buttons can be released



IMPORTANT NOTE: to execute the Steam-Out procedure the DREGDRAWER must be in place and the DOOR must be closed. If these 2 conditions are not respected a warning message is shown on the display and the Steam-Out is interrupted.

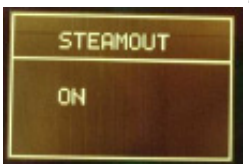

The machine starts the Steam Out and the display change the backlight (yellow) and appears the indication "ON". While the Steam Out runs the Electrovalve is opened and water comes out the Water/Steam pipe.



When the Steam Out is complete the message "COMPLETE" is shown on the Display. The Electrovalve automatically closes and the machine can be switched off.

When the Steam-Out is complete the following parameters are reset to their default values:

Count Coffee

Aroma

Length Espresso product

Length Coffee product

Filter Presence

Filter Pulses

Aroma Impulses

Dynamic threshold

History of grindings for Beans Presence detection

StandBy Time

The request for Priming the Circuit at the first switch on is set.

5.4.1. Minuto Focus/Class test mode for USA

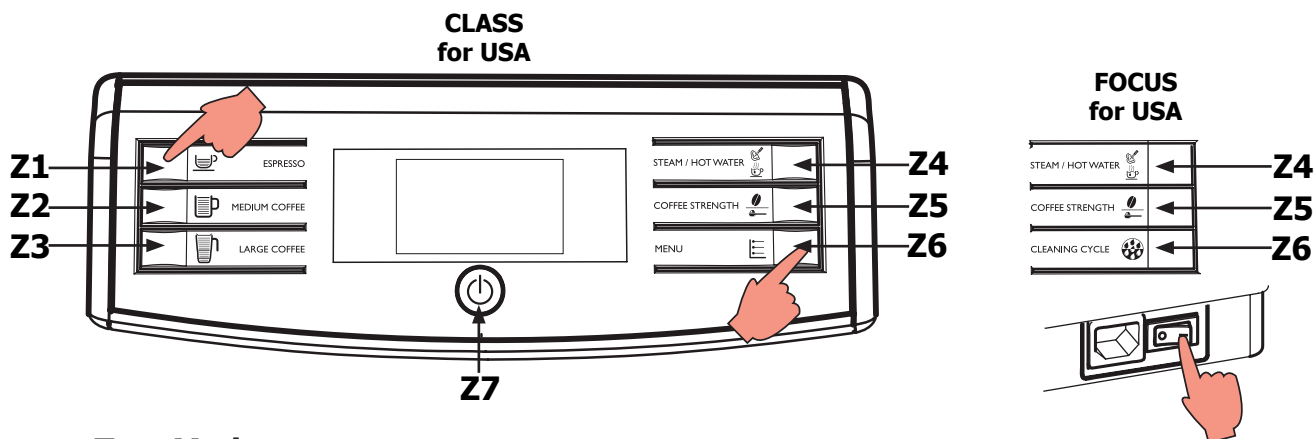

To enter Test Mode

The machine enters Test Mode by holding pressed together Z1 and Z6 buttons (or Cleaning cycle button in Focus version) while switching on the machine by mean of the main switch on the back-side of the CA. Once entered in Test Mode, the display shows the firmware version.

The Test Mode is organized into **5 different pages** :

Page 0: The display shows:

- Firmware version.
- CLASS or FOCUS type.
- Voltage supply.
- Main supply frequency.

Page 1: Keyboard and display's colour test:

- Z1 button
- Z2 button
- Z3 button
- Z4 button
- Z5 button
- Z6 button
- Z7 button
- Backlight colors

Page 2: Input signals test:

- Water level sensor
- Microswitch door closed/opened
- Microswitch presence of the Brew Unit
- Lever position on Espresso
- Lever position on Drip

Page 3: Low voltage loads test:

- Brew Unit movement upward and downward (24V DC)

Page 4: High/Low voltage loads test (Pump, E.Valve) :

- Pump (AC voltage)
- Electro Valve (24Vdc) (The door must be closed !!)

Page 5: High voltage loads test (Heater , Grinder) :

- Heater (120-230V AC)
- Grinder (170-320V DC)

Firmware Software version



Firmware version on the display.

The machine model is shown (FOCUS or CLASS).

The voltage of the main supply "230V/120V"

The frequency of the main supply is shown (50 or 60 Hz)

ERROR: If machine model is different from CLASS or FOCUS, change the interface.

Press STAND_BY "  " to move to the next screen

Operational check – keys



Start condition

Only when a button is pressed a O appears on the relative position of button pressed.

In the middle of display appears the name of the button pressed.

Pressing buttons on the left the backlight color changes from GREEN to YELLOW.

Pressing button on the right the backlight color changes from GREEN to RED.

When a button is pressed, also the Stand-By led (RED) turn ON.

Note: Press button STANDBY as the last once, since it makes change the test page.

Note: If 2 or more buttons are pressed the name that appears on display could be wrong.

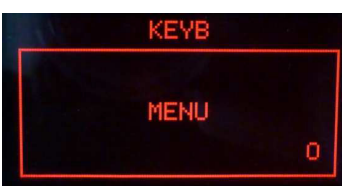

ERROR:

If nothing appears on display; check the interface board and the flat cable (JP21).

If during the movement the backlight remain green check the wiring (JP1) from the interface board and the display.

The name displayed is wrong; check the position of jumper in interface. It must be the same of machine model:

- Jumper on JP5 for Focus machine model
- Jumper on JP6 for Class machine model

Press STAND_BY "  " to move to the next screen

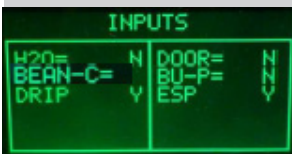

Start condition

Insert a full Water Tank

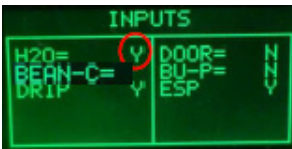

The indication H2O changes from "N" to "Y".

NOTE: the switching from "N" to "Y" requires about 1-2 seconds.

ERROR: The indication TANK-H2O doesn't change; check the capacitive sensor (fixing) and the wiring (JP23)

Insert the BrewUnit

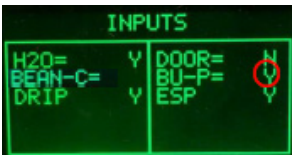

The indications BU-P changes from "N" to "Y".

NOTE: removing the BrewUnit the indication from "Y" to "N" requires about 2-3 seconds to switch.

ERROR: Check the BU presence Microswitch and the wiring (JP16).

Close the Door and Dreg Drawer

The indication DOOR change from "N" to "Y"

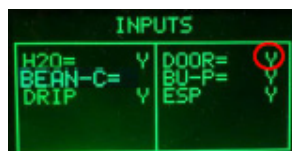

ERROR: The indication DOOR does not change; check the Microswitch for the door and the wiring (JP14). NOTE: without the Dreg Drawer correctly inserted the DOOR indication cannot change !

Insert the Coffee Beans Cover (120V NA only)

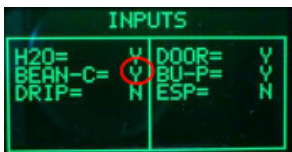

The indications BEAN-C changes from "N" to "Y".

ERROR: The indication BEAN-C does not change; check the reed for the cover and the wiring (JP25).

Move Pressure Lever in DRIP position

The indications DRIP changes from "N" to "Y".

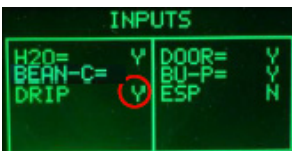

Move Pressure Lever in ESPRESSO position

The indication ESP change from "N" to "Y".

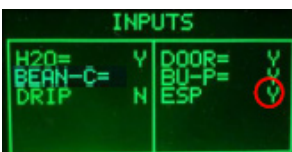

IMPORTANT NOTE: If the Pressure Lever is not inserted (on 120V version) a warning message will be shown and the display turns to yellow..

Check JP4 on interface board.



Press the STAND-BY button

The machine passes to the Page 3 (BU PAGE)

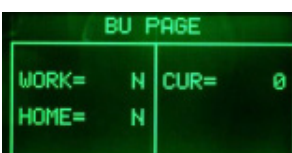

Press STAND_BY " ⏻ " to move to the next screen

Operational check – brewing unit

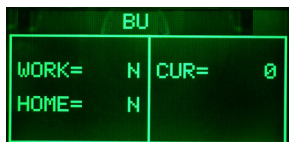

Start condition



Press the Z1 button to move the BU to Work

IMPORTANT

NOTE: If the DREGDRAWER is not inserted or the DOOR is not closed the BU test cannot be performed. If these 2 inputs are not in the right position, a warning message will be shown and the display turns to yellow..

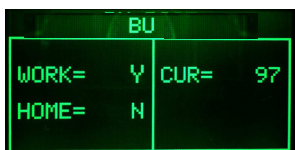

When the BU reaches the work position the indication **WORK** changes from "N" to "Y", the number of the current is minus than 200mA (without BU) or 300mA (with BU).

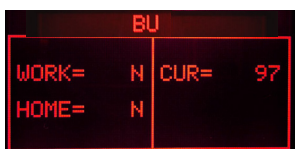

ERROR: The indication **WORK** doesn't change and remain "N", the display backlight changes from green to red; Check the work microswitch (broken?), the BU motor (blocked?) and the wiring (JP16)

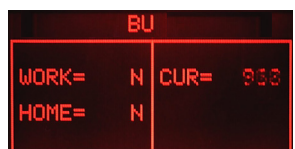

ERROR: **(Without BU)** The absorbed current is more than 200mA, the display backlight changes from green to red; check the BU and the motor.

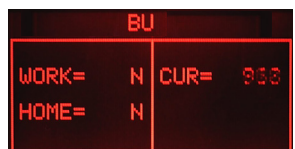

ERROR: **(With BU)** The absorbed current is more than 300mA, the display backlight changes from green to red; check the BU and the motor

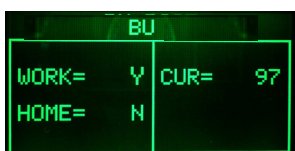

Press the Z3 button to move the BU to Home

When the BU reaches the home position the indication **HOME** changes from "N" to "Y", the number of the current is minus than 200mA (without BU) or 300mA (with BU).



ERROR: The indication **HOME** doesn't change and remain "N", the display backlight changes from green to red; Check the work microswitch (is broken), the BU motor (is blocked) and the wiring (JP16).

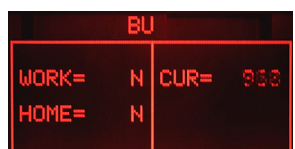

ERROR: **(Without BU)** The absorbed current is higher than 200mA, the display backlight changes from green to red; check the BU and the motor.

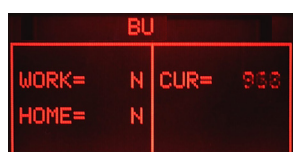

ERROR: **(With BU)** The absorbed current is higher than 300mA, the display backlight changes from green to red; check the BU and the motor

Press STAND_BY "  " to move to the next screen

Operational check - solenoid valves and pump

EV	PUMP
EV1 OFF	IMP= 0 L/H= 0

Start condition

EV	PUMP
EV1 OFF	IMP= 0 L/H= 0
CHECK DREG	DOOR

Press the Z1 button to open the Electro Valve

IMPORTANT NOTE: If the DREGDRAWER is not inserted or the DOOR is not closed the EV test cannot be performed. If these 2 inputs are not in the right position, a warning message will be shown and the display turns to yellow.

EV	PUMP
EV1 ON	IMP= 0 L/H= 0

It is possible to hear the "click" from Electro Valve. The indication beside the **EV1** changes from "OFF" to "ON".

EV	PUMP
EV1 ON	IMP= 69 L/H= 13

Press the Z4 button to switch on the pump

The water goes out from the pipe and the indication **IMP** shows increasing numbers. The indication L/H must be within the range 10-18.

EV	PUMP
EV1 ON	IMP= 0 L/H= 0

ERROR: The display backlight changes from green to red and the impulse remains 0; If water comes out the pipe: check the wiring from the flowmeter to the CPU/POWER board (JP5). If no water comes out the pipe: check the pump and the wiring from the pump to the CPU/POWER board (JP24).

EV	PUMP
EV1 ON	IMP= 69 L/H= 0

ERROR: The L/H is zero or very low; the Electro Valve does not open. Check the wiring from the Electro Valve to the CPU/POWER board (JP3) and the Electro Valve.

Press STAND_BY " ⏻ " to move to the next screen

Operational check - coffee grinder and boiler

HEATER	GRINDER
OFF 30	0 0 15

Initial status

HEATER	GRINDER
34	COVER NP 0 120 18

Press the Z4 button to switch on the grinder

IMPORTANT NOTE: If the COFFEE BEANS Cover is not inserted the Grinder test cannot be performed in 120V. If this input is not in the right position, a warning message will be shown and the display turns to yellow.

HEATER	GRINDER
41	29 0 90 17

The grinder rotates and in the indication GRINDER the number increasing up to 40. The other numbers inside the GRINDER box are not important for this test.

HEATER	GRINDER
OFF 30	0 120 18

ERROR: The number remains 0 or the grinder does not run, the display backlight changes from green to red; check the Hall sensor board of the Grinder, the Grinder, the wiring from the Hall sensor board to the CPU/POWER board (JP2) and the wiring from the Grinder to the CPU/POWER board (JP8)

HEATER	GRINDER
OFF 30	0 0 15

Check the temperature

The number shows the heater temperature .

HEATER	GRINDER
75 SHORT	0 0 90 18

ERROR: In the indication HEATER appears "SHORT", the NTC temperature-sensor is shorted, the display backlight changes from green to red; check the wiring from the NTC temperature-sensor to the CPU/POWER board (JP13).

HEATER	GRINDER
127 OPEN	40 38 90 18

ERROR: In the indication HEATER appears "OPEN", the NTC temperature-sensor is detached or broken, the display backlight changes from green to red; check the wiring from the NTC temperature-sensor to the CPU/POWER board (JP13).

HEATER	GRINDER
ON 49	40 15 14

Press the Z1 button to switch on the Heater

The absorbed current (Amperometer on the main supply) is OK, the indication HEATER changes from "OFF" to "ON" and the temperature starts increasing.

HEATER	GRINDER
OFF 137 TEMP>135!!	40 38 90 18

If temperature is over 135°C, the backlight change from GREEN to YELLOW. This is a ALERT message to avoid heating the HEATER element over dangerous temperature.

ERROR: the absorbed current is KO or the temperature does not increase; check the wiring from the heater to the CPU/POWER board (JP19) and the wiring of the NTC temperature-sensor (JP13).

5.4.2. SteamOut

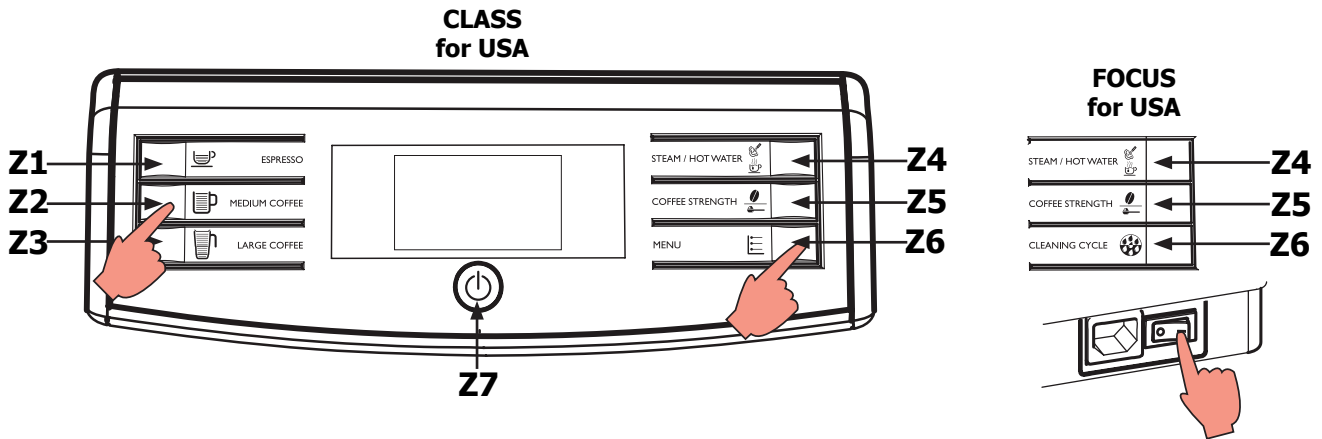

To enter in SteamOut

The machine enters SteamOut mode by holding pressed together the Z2 button and the Z6 button while switching on the machine.

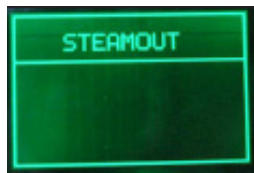

Once entered the Steam Out mode the display shows the "STEAM OUT" indication. Buttons can be released



IMPORTANT NOTE: to execute the Steam-Out procedure the DREGDRAWER must be in place and the DOOR must be closed. If these 2 conditions are not respected a warning message is shown on the display and the Steam-Out is interrupted.



The machine starts the Steam Out and the display change the backlight (yellow) and appears the indication "ON". While the Steam Out runs the Electrovalve is opened and water comes out the Water/Steam pipe.



When the Steam Out is complete the message "COMPLETE" is shown on the Display. The Electrovalve automatically closes and the machine can be switched off.

When the Steam-Out is complete the following parameters are reset to their default values:

- Count Coffee
 - Aroma
 - Length Espresso product
 - Length Medium Coffee product
 - Filter Presence
 - Filter Pulses
 - Aroma Impulses
 - Dynamic threshold
 - History of grindings for Beans Presence detection
 - StandBy Time
- The request for Priming the Circuit at the first switch on is set.

5.5.1. Minuto Pure test mode

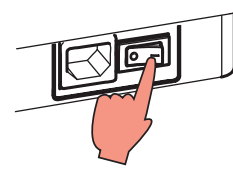

To enter Test Mode

The machine enters Test Mode by holding pressed together Espresso and CalcClean buttons while switching on the machine by mean of the main switch on the backside of the CA. Once entered shows Led Coffee Single, Led Coffee Double flashing in series (Level 0). There are **6 different level**, in each level the coffee-machine can execute different commands,

Level 0: Entry Level:

a) In this level can be done Reset to default

Level 1: The machine can test the button:

- a) Button Espresso
- b) Button Coffee
- c) Button Calc_Clean
- d) No Water LED
- e) Alarm General LED
- f) Decale LED
- g) Rinsing LED
- h) Drip Tray/Coffee Dreg Drawer LED
- i) No Beans LED

Level 2: The machine can test other input signal:

- a) Microswitch door closed/opened
- b) Microswitch present of the brewing unit
- c) Microswitch present of the dregdrawer

Level 3: The machine can test the loads in low voltage:

- a) Brew Unit movement upward and downward (24V DC)

Level 4: The machine can test the load in high voltage:

- a) Pump (100-120-230V AC)
- a. Brew Unit must be in inserted and in Work position.

Level 5: The machine can test two loads in high voltage (Heater , Grinder):

- a) Heater (100-120-230V AC)
- b) Grinder (140-170-320V DC)

The user can switch the level by pressing the Button ON/OFF, the machine shows the level of the test:

- a) Level 1:** Led Espresso ON (G), Led Stand-by ON (R)
- b) Level 2:** Led Espresso ON (G), Led Descale ON (O)
- c) Level 3:** Led Espresso ON (G), Led Descale ON (O), Led CalcClean ON (O)
- d) Level 4:** Led Espresso ON (G), Led Descale ON (O), Led CalcClean ON (O), Led Rinsing ON (O)
- e) Level 5:** Led Espresso ON (G), Led Descale ON (O), Led CalcClean ON (O), Led Rinsing ON (O), Led Coffee ON (G).

Legend:

(O) = Orange

(G) = Green

(R) = Red

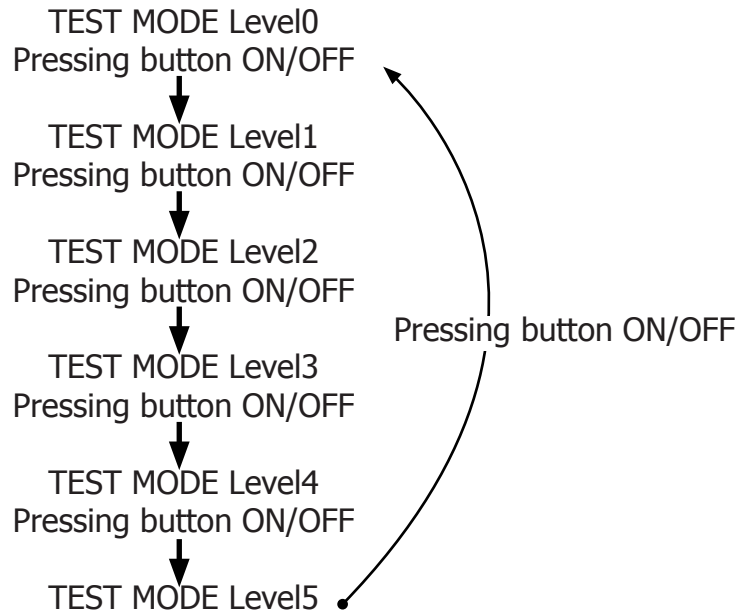

At the start up all loads are turned off. The software allow to have only one load active at the same time.

Level 0 (Start Test mode)

Start condition: NO BU, NO drag drawer, door open, No Water sensor	LED INDICATION	
	Led Espresso	Led Coffee
	Blink Alternately	

Press BUTTON ON/OFF to move to the next screen

Level 1 (Key)

Start condition: NO BU, NO drag drawer, door open and No Water sensor	LED INDICATION					
	Led NoBeans	Led NoWater	Led GenAlarm	Led Dreg	Led Descale	Led Rinsing
	OFF	OFF	OFF	OFF	OFF	OFF

Press Espresso Button						
Action by user	LED INDICATION					
	Led NoBeans	Led NoWater	Led GenAlarm	Led Dreg	Led Descale	Led Rinsing
Switch on Red Leds NoWater & GenAlarm	OFF	ON	ON			
ERROR: Led NoWater remains off, check the interface board and flat cable (JP21)		OFF	ON			
ERROR: Led GenAlarm remains off, check the interface board and flat cable (JP21)		ON	OFF			
ERROR: Led NoWater & GenAlarm remain off, check the interface board and flat cable (JP21)		OFF	OFF			

Press CalcClean Button						
Action by user	LED INDICATION					
	Led NoBeans	Led NoWater	Led GenAlarm	Led Dreg	Led Descale	Led Rinsing
Switch on Orange Leds Descale & Rinsing	OFF	OFF	OFF	OFF	ON	ON
ERROR: Led Descale remains off, check the interface board and flat cable (JP21)					OFF	ON
ERROR: Led Rinsing remains off, check the interface board and flat cable (JP21)					ON	OFF
ERROR: Led Descale & Rinsing remain off, check the interface board and flat cable (JP21)					OFF	OFF

Press Coffee Button						
Action by user	LED INDICATION					
	Led NoBeans	Led NoWater	Led GenAlarm	Led Dreg	Led Descale	Led Rinsing
Switch on Red Leds Dreg & NoBeans	ON	OFF	OFF	ON		
ERROR: Led NoBeans remains off, check the interface board and flat cable (JP21)	OFF			ON		
ERROR: Led Dreg remains off, check the interface board and flat cable (JP21)	ON			OFF		
ERROR: Led NoBeans & Dreg remain off, check the interface board and flat cable (JP21)	OFF			OFF		

Finish condition: NO BU, NO drag drawer, door open and No Water sensor	LED INDICATION					
	Led NoBeans	Led NoWater	Led GenAlarm	Led Dreg	Led Descale	Led Rinsing
	OFF	OFF	OFF	OFF	OFF	OFF

Press BUTTON ON/OFF to move to the next screen

Level 2 (Input)

Start condition: NO BU, NO drag drawer, door open and No Water sensor	LED INDICATION			
	Led NoBeans	Led NoWater	Led GenAlarm	Led Dreg
	OFF	ON	ON	ON
Insert a full Water Tank				
Action by user	LED INDICATION			
	Led NoBeans	Led NoWater	Led GenAlarm	Led Dreg
	NA	OFF	NA	NA
Switch off Red Leds NoWater	NA	OFF	NA	NA
ERROR: Led NoWater remains on, check the capacitive sensor (fixing) and the wiring (JP23)	NA	ON	NA	NA
Insert the Brew Unit				
Action by user	LED INDICATION			
	Led NoBeans	Led NoWater	Led GenAlarm	Led Dreg
	NA	NA	OFF	NA
Switch off Red Leds GenAlarm	NA	NA	OFF	NA
ERROR: Led GenAlarm remains on, check the BU presence Microswitch and the wiring (JP16).	NA	NA	ON	NA
Close the door and Dreg Drawer				
Action by user	LED INDICATION			
	Led NoBeans	Led NoWater	Led GenAlarm	Led Dreg
	NA	NA	NA	OFF
Switch off Red Led Dreg	NA	NA	NA	OFF
ERROR: Led Dreg remains on, check the Microswitch for the door and the wiring (JP14). NOTE: without the Dreg Drawer correctly inserted the DOOR indication cannot change!	NA	NA	NA	ON
Finish condition: With BU, Drag Drawer, door closed and Tank	LED INDICATION			
	Led NoBeans	Led NoWater	Led GenAlarm	Led Dreg
	OFF	OFF	OFF	OFF

Press BUTTON ON/OFF to move to the next screen

Level 3 (Brewing unit)

Start condition: NO BU, Drag drawer, door Closed and No Water sensor	LED INDICATION			
	Led NoBeans	Led NoWater	Led GenAlarm	Led Dreg
	OFF	OFF	OFF	OFF
If the DREGDRAWER is not inserted or the DOOR is not closed the BU test cannot be performed. If these 2 inputs are not in the right position, Led Dreg will be RED	NA	NA	NA	ON

Press the Espresso button to move BU to work				
Action by user	LED INDICATION			
	Led NoBeans	Led NoWater	Led GenAlarm	Led Dreg
When the BU reaches the work position the Led NoBeans is switched on	ON	NA	NA	NA
ERROR: Led Dreg remains on, check the Microswitch for the door and the wiring (JP14). NOTE: without the Dreg Drawer correctly inserted the DOOR indication cannot change!	NA	NA	NA	NA
ERROR: led GenAlarm Switch ON; the absorbed current is much more 300mA (with BU) or 200mA (without BU) check the BU and the motor	NA	NA	ON	NA

Press the Coffee button to move BU to home				
Action by user	LED INDICATION			
	Led NoBeans	Led NoWater	Led GenAlarm	Led Dreg
When the BU reaches the work position the Led NoBeans is switched on	ON	NA	NA	NA
ERROR: Led NoBeans remains off, Check the work microswitch (broken?), the BU motor (blocked?) and the wiring (JP16).	NA	NA	NA	NA
ERROR: led GenAlarm Switch ON; the absorbed current is much more 300mA (with BU) or 200mA (without BU) check the BU and the motor	NA	NA	ON	NA

Finish condition: With BU, Drag Drawer, door closed	LED INDICATION			
	Led NoBeans	Led NoWater	Led GenAlarm	Led Dreg
	OFF	OFF	OFF	OFF

Press BUTTON ON/OFF to move to the next screen

Level 4 (Pump)

Start condition: BU inserted, Drag drawer, door Closed and No Water sensor	LED INDICATION			
	Led NoBeans	Led NoWater	Led GenAlarm	Led Dreg
	OFF	OFF	OFF	OFF
If the DREGDRAWER is not inserted or the DOOR is not closed the BU cannot be moved in work position and test cannot be performed. If these 2 inputs are not in the right position, Led Dreg will be RED	NA	NA	NA	ON
If the BU is not inserted, the test will not be performed, so Led GenAlarm will be switched ON	NA	NA	ON	NA

Press the Espresso button to move BU to work				
Action by user	LED INDICATION			
	Led NoBeans	Led NoWater	Led GenAlarm	Led Dreg
When the BU reaches the work position the Led NoBeans is switched on	ON	NA	NA	NA
ERROR: Led NoBeans remains off, Check the work microswitch (broken?), the BU motor (blocked?) and the wiring (JP16).	NA	NA	NA	NA

Press the Coffee button to switch on the Pump				
Action by user	LED INDICATION			
	Led NoBeans	Led NoWater	Led GenAlarm	Led Dreg
The water goes out from the dispensing spout, the NoWater LED blink every Flowmeter pulse	NA	BLINK	NA	NA
ERROR: the NoWater LED doesn't flashing and after 5sec this LED Switch ON; check: 1) the BU is in work position, 2) pump, 3) the flowmeter, 4) the wiring from the flowmeter to the CPU/POWER board (JP5) 5) the wiring from the pump to the CPU/POWER board (JP24)	NA	ON	NA	NA

Press the Espresso button to move BU to Home				
Action by user	LED INDICATION			
	Led NoBeans	Led NoWater	Led GenAlarm	Led Dreg
When the BU leave the work position the Led NoBeans is switched off, and BU move to Home Position to end L4 Test	OFF	NA	NA	NA

Finish condition: With BU, Drag Drawer, door closed	LED INDICATION			
	Led NoBeans	Led NoWater	Led GenAlarm	Led Dreg
	OFF	OFF	OFF	OFF

Press BUTTON ON/OFF to move to the next screen

Level 5 (Grinder-Heater)

Start condition: NO BU, NO drag drawer, door open and No Water sensor	LED INDICATION			
	Led NoBeans	Led NoWater	Led GenAlarm	Led Dreg
	OFF	OFF	OFF	OFF

Check the Temperature

Action by user	LED INDICATION			
	Led NoBeans	Led NoWater	Led GenAlarm	Led Dreg
The red led General Alarm remains OFF	NA	NA	OFF	NA
ERROR: The temperature sensor is shorted or opened, the led GenAlarm switch ON; check the wiring from the heater to the CPU/POWER board (JP13).	NA	NA	ON	NA

Press the Espresso button to switch on the Heater

Action by user	LED INDICATION			
	Led NoBeans	Led NoWater	Led GenAlarm	Led Dreg
The user checkers that the absorbed current is OK	NA	NA	OFF	NA
ERROR: the absorbed current is KO; check the wiring from the heater to the CPU/POWER board (JP17-3) and the other wiring	NA	NA	OFF	NA
ERROR: If temperature is over 100°C, the NoWater LED turn ON. This is a ALERT message to avoid heating the HEATER element over dangerous temperature; and Heater test cannot be performed.			ON	

Press the Coffee button to switch on the Grinder

Action by user	LED INDICATION			
	Led NoBeans	Led NoWater	Led GenAlarm	Led Dreg
The grinder rotates and Led NoBeans Blink	BLINK	NA	OFF	NA
ERROR: the led NoBeans remains OFF and after the led NoBeans switch ON; check the hall sensor board in the Grinder, the Grinder, the wiring from the hall sensor board to the CPU/POWER board (JP2) and the wiring from the Grinder to the CPU/POWER board (JP8)	ON	NA	OFF	NA

Finish condition: With BU, Drag Drawer, door closed

	LED INDICATION			
	Led NoBeans	Led NoWater	Led GenAlarm	Led Dreg
	OFF	OFF	OFF	OFF

5.5.2. SteamOut

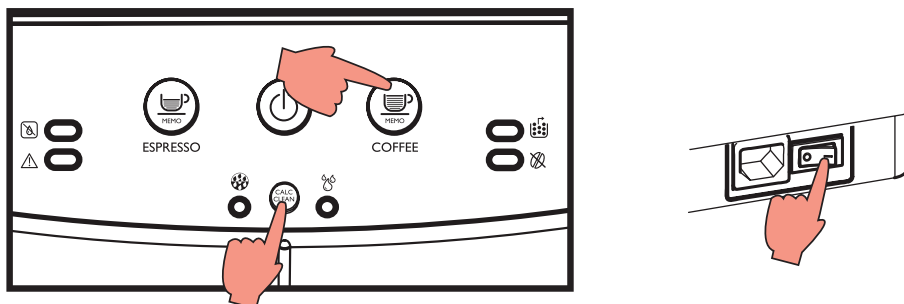

To enter in SteamOut

The machine enters SteamOut mode by holding pressed together the **COFFEE** button and the **CALC_CLEAN** button while switching on the machine.

Once entered shows Led Descale and Led Rinsing flashing in series.

If brewing unit is not inserted in the machine, LED General Alarm will be switched on.
If Door is opened or drag drawer is removed LED WASTE FULL will be switched on.

In these 2 conditions Brewing Unit cannot be moved at work so SteamOut will not be performed;
After Brewing Unit reach work position SteamOut start.

At the end of procedure Brewing Unit will be moved to rest position and LED ESPRESSO and LED COFFEE turns on.

When the Steam-Out is complete the following parameters are reset to their default values:

- Count Coffee
- Aroma
- Length Espresso product
- Length Coffee product
- Filter Presence
- Filter Pulses
- Aroma Impulses
- Dynamic threshold
- History of grindings for Beans Presence detection
- StandBy Time
- The request for Priming the Circuit at the first switch on is set.

5.6.1. Minuto Pure test mode for USA

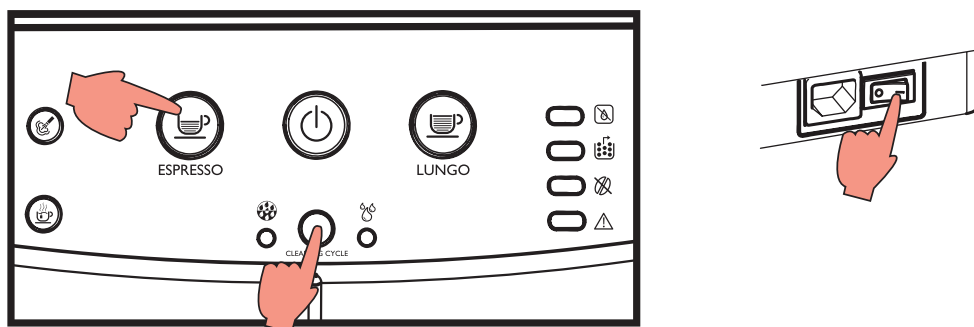

To enter Test Mode

The machine enters Test Mode by holding pressed together Espresso and CalcClean buttons while switching on the machine by mean of the main switch on the backside of the CA.

Once entered shows Led Coffee Single, Led Coffee Double flashing in series (Level 0).

There are **6 different level**, in each level the coffee-machine can execute different commands,

Level 0: Entry Level:

a) In this level can be done Reset to default

Level 1: The machine can test the button:

- a) Button Espresso
- b) Button Coffee
- c) Button Steam
- d) Button Hot Water
- e) Button Calc_Clean
- f) No Water LED
- g) Alarm General LED
- h) Drip Tray/Coffee Dreg Drawer LED
- i) No Beans LED
- j) Decale LED
- k) Rinsing LED

Level 2: The machine can test other input signal:

- a) Microswitch door closed/opened & dregdrawer
- b) Microswitch present of the brewing unit
- c) Water sensor
- d) Coffee beans cover sensor

Level 3: The machine can test the loads in low voltage:

- a) Brew Unit movement upward and downward (24V DC)

Level 4: The machine can test:

- a) Pump (100-120 AC)
- a. Electro-valve.

Level 5: The machine can test two loads in high voltage (Heater , Grinder):

- a) Heater (100-120 AC)
- b) Grinder (140-170 DC)

The user can switch the level by pressing the Button ON/OFF, the machine shows the level of the test:

- a) Level 1:** Led Espresso ON (G), Led Stand-by ON (R)
- b) Level 2:** Led Espresso ON (G), Led Descale ON (O)
- c) Level 3:** Led Espresso ON (G), Led Descale ON (O), Led CalcClean ON (O)
- d) Level 4:** Led Espresso ON (G), Led Descale ON (O), Led CalcClean ON (O), Led Rinsing ON (O)
- e) Level 5:** Led Espresso ON (G), Led Descale ON (O), Led CalcClean ON (O), Led Rinsing ON (O), Led Coffee ON (G).

Legend:

- (O) = Orange**
- (G) = Green**
- (R) = Red**

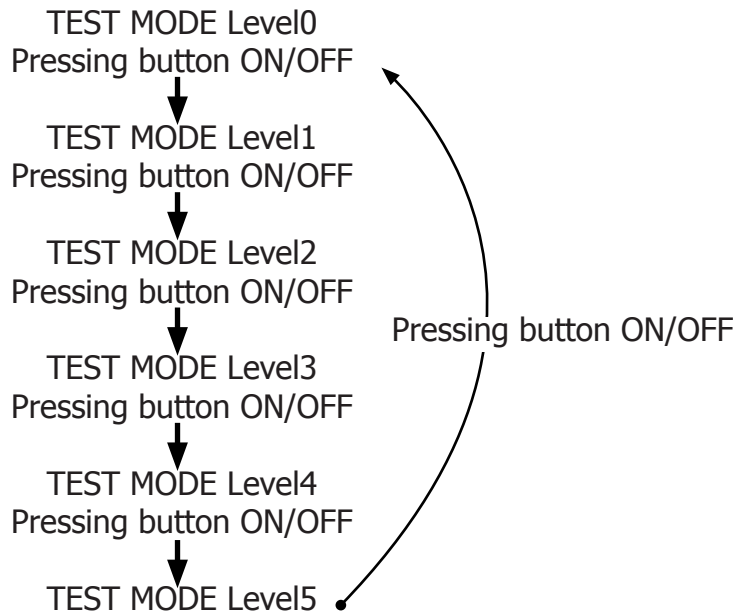

At the start up all loads are turned off. The software allow to have only one load active at the same time.

Level 0 (Start Test mode)

Start condition: NO BU, NO drag drawer, Door open, No Water in tank, Coffee Beans cover open	LED INDICATION	
	Led Espresso	Led Coffee
	Blink Alternately	

Press BUTTON ON/OFF to move to the next screen

Level 1 (Key)

Start condition: NO BU, NO drag drawer, Door open, No Water in tank, Coffee Beans cover open	LED INDICATION					
	Led NoBeans	Led NoWater	Led GenAlarm	Led Dreg	Led Descale	Led Rinsing
	OFF	OFF	OFF	OFF	OFF	OFF

Press Espresso Button						
Action by user	LED INDICATION					
	Led NoBeans	Led NoWater	Led GenAlarm	Led Dreg	Led Descale	Led Rinsing
Switch on Red Leds NoWater & GenAlarm	OFF	ON	OFF	ON	OFF	OFF
ERROR: Led NoWater remains off, check the interface board and flat cable (JP21)		OFF		ON		
ERROR: Led Dreg remains off, check the interface board and flat cable (JP21)		ON		OFF		
ERROR: Led NoWater & Dreg remain off, check the interface board and flat cable (JP21)		OFF		OFF		

Press CalcClean Button						
Action by user	LED INDICATION					
	Led NoBeans	Led NoWater	Led GenAlarm	Led Dreg	Led Descale	Led Rinsing
Switch on Orange Leds Descale & Rinsing	OFF	OFF	OFF	OFF	ON	ON
ERROR: Led Descale remains off, check the interface board and flat cable (JP21)					OFF	ON
ERROR: Led Rinsing remains off, check the in- terface board and flat cable (JP21)					ON	OFF
ERROR: Led Descale & Rinsing remain off, check the interface board and flat cable (JP21)					OFF	OFF

Press Coffee Button						
Action by user	LED INDICATION					
	Led NoBeans	Led NoWater	Led GenAlarm	Led Dreg	Led Descale	Led Rinsing
Switch on Red Leds Dreg & NoBeans	ON	OFF	ON	OFF	OFF	OFF
ERROR: Led NoBeans remains off, check the interface board and flat cable (JP21)	OFF		ON			
ERROR: Led GenAlarm remains off, check the interface board and flat cable (JP21)	ON		OFF			
ERROR: Led NoBeans & GenAlarm remain off, check the interface board and flat cable (JP21)	OFF		OFF			

Press Steam Button		
Action by user	LED INDICATION	
	Led Steam Button	Led HotWater Button
Switch on Steam Button LED	ON	OFF
ERROR: Led Steam Button remains off, check the interface board and flat cable (JP21)	OFF	OFF

Press Steam Button		
Action by user	LED INDICATION	
	Led Steam Button	Led HotWater Button
Switch on Hot Water Button LED	OFF	ON
ERROR: Led Hot Water Button remains off, check the interface board and flat cable (JP21)	OFF	OFF

Finish condition: NO BU, NO drag drawer, Door open, No Water in tank, Coffee Beans cover open	LED INDICATION					
	Led NoBeans	Led NoWater	Led GenAlarm	Led Dreg	Led Descale	Led Rinsing
	OFF	OFF	OFF	OFF	OFF	OFF

Press BUTTON ON/OFF to move to the next screen

Level 2 (Input)

Start condition: NO BU, NO drag drawer, Door open, No Water in tank, Coffee Beans cover open	LED INDICATION			
	Led NoBeans	Led NoWater	Led GenAlarm	Led Dreg
	ON	ON	ON	ON

Insert a full Water Tank				
Action by user	LED INDICATION			
	Led NoBeans	Led NoWater	Led GenAlarm	Led Dreg
Switch off Red Leds NoWater	NA	OFF	NA	NA
ERROR: Led NoWater remains on, check the capacitive sensor (fixing) and the wiring (JP23)	NA	ON	NA	NA

Insert the Brew Unit				
Action by user	LED INDICATION			
	Led NoBeans	Led NoWater	Led GenAlarm	Led Dreg
Switch off Red Leds GenAlarm	NA	NA	OFF	NA
ERROR: Led GenAlarm remains on, check the BU presence Microswitch and the wiring (JP16).	NA	NA	ON	NA

Close the door and Dreg Drawer				
Action by user	LED INDICATION			
	Led NoBeans	Led NoWater	Led GenAlarm	Led Dreg
Switch off Red Led Dreg	NA	NA	NA	OFF
ERROR: Led Dreg remains on, check the Microswitch for the door and the wiring (JP14). NOTE: without the Dreg Drawer correctly inserted the DOOR indication cannot change!	NA	NA	NA	ON

Close coffee beans cover				
Action by user	LED INDICATION			
	Led NoBeans	Led NoWater	Led GenAlarm	Led Dreg
Switch off Red Leds GenAlarm	OFF	NA	NA	NA
ERROR: Led GenAlarm remains on, check the BU presence Microswitch and the wiring (JP16).	ON	NA	NA	NA

Finish condition: With BU, NO drag drawer inserted, Door closed, Water in tank, Coffee Beans cover closed	LED INDICATION			
	Led NoBeans	Led NoWater	Led GenAlarm	Led Dreg
	OFF	OFF	OFF	OFF

Press BUTTON ON/OFF to move to the next screen

Level 3 (Brewing unit)

Start condition: NO BU, Drag drawer inserted, door closed, No Water sensor, Coffee beans cover open	LED INDICATION			
	Led NoBeans	Led NoWater	Led GenAlarm	Led Dreg
	OFF	OFF	OFF	OFF
If the DREGDRAWER is not inserted or the DOOR is not closed the BU test cannot be performed. If these 2 inputs are not in the right position, Led Dreg will be RED	NA	NA	NA	ON

Press the Espresso button to move BU to work				
Action by user	LED INDICATION			
	Led NoBeans	Led NoWater	Led GenAlarm	Led Dreg
When the BU reaches the work position the Led NoBeans is switched on	ON	NA	NA	NA
ERROR: Led NoBeans remains off, Check the work microswitch (broken?), the BU motor (blocked?) and the wiring.	NA	NA	NA	NA
ERROR: led GenAlarm Switch ON; the absorbed current is much more 300mA (with BU) or 200mA (without BU) check the BU and the motor	NA	NA	ON	NA

Press the Coffee button to move BU to home

Action by user	LED INDICATION			
	Led NoBeans	Led NoWater	Led GenAlarm	Led Dreg
When the BU reaches the work position the Led NoBeans is switched on	ON	NA	NA	NA
ERROR: Led NoBeans remains off, Check the work microswitch (broken?), the BU motor (blocked?) and the wiring.	NA	NA	NA	NA
ERROR: led GenAlarm Switch ON; the absorbed current is much more 300mA (with BU) or 200mA (without BU) check the BU and the motor	NA	NA	ON	NA

Finish condition: No BU, Drag Drawer inserted, door closed, No Water sensor, Coffee beans cover open

LED INDICATION

	Led NoBeans	Led NoWater	Led GenAlarm	Led Dreg
		OFF	OFF	OFF

Press BUTTON ON/OFF to move to the next screen

Level 4 (Pump)

Start condition: No BU, Drag drawer, door Closed and No Water sensor, Coffee beans cover closed

LED INDICATION

	Led NoBeans	Led NoWater	Led GenAlarm	Led Dreg
		OFF	OFF	OFF
If the DREGDRAWER is not inserted or the DOOR is not closed the BU cannot be moved in work position and test cannot be performed. If these 2 inputs are not in the right position, Led Dreg will be RED	NA	NA	NA	ON

Press the Espresso Button

Action by user

LED INDICATION

	Led NoBeans	Led NoWater	Led GenAlarm	Led Dreg
	Turn On Ev1	ON	NA	NA
ERROR: If Ev remain closed check EV (broken?), and the wiring	ON	NA	NA	NA

Press the Lungo button to switch on the Pump

Action by user

LED INDICATION

	Led NoBeans	Led NoWater	Led GenAlarm	Led Dreg
	The water goes out from the dispensing spout, the NoWater LED blink every Flowmeter pulse	NA	BLINK	NA
ERROR: the NoWater LED doesn't flashing and after 5sec this LED Switch ON; check: 1) EV open?, 2) pump, 3) the flowmeter, 4) the wiring from the flowmeter to the CPU/POWER board (JP5) 5) the wiring from the pump to the CPU/POWER board (JP24)	NA	ON	ON	NA

Finish condition: No BU, Drag drawer, door Closed and No Water sensor, Coffee beans cover closed	LED INDICATION			
	Led NoBeans	Led NoWater	Led GenAlarm	Led Dreg
	OFF	OFF	OFF	OFF

Press BUTTON ON/OFF to move to the next screen

Level 5 (Grinder-Heater)

Start condition: NO BU, NO drag drawer, door open and No Water sensor	LED INDICATION			
	Led NoBeans	Led NoWater	Led GenAlarm	Led Dreg
	OFF	OFF	OFF	OFF
If the Coffee Beans cover is opened the grinder is disabled and test cannot be performed. If this input are not in the right position, Led NoBeans & Led Dreg will be RED	ON	NA	NA	ON

Check the Temperature

Action by user	LED INDICATION			
	Led NoBeans	Led NoWater	Led GenAlarm	Led Dreg
	NA	NA	OFF	NA
The red led General Alarm remains OFF	NA	NA	OFF	NA
ERROR: The temperature sensor is shorted or opened, the led GenAlarm switch ON; check the wiring from the heater to the CPU/POWER board (JP13).	NA	NA	ON	NA

Press the Espresso button to switch on the Heater

Action by user	LED INDICATION			
	Led NoBeans	Led NoWater	Led GenAlarm	Led Dreg
	NA	NA	OFF	NA
The user checkers that the absorbed current is OK	NA	NA	OFF	NA
ERROR: the absorbed current is KO; check the wiring from the heater to the CPU/POWER board (JP17-3) and the other wiring, or thermostats.	NA	NA	OFF	NA
ERROR: If temperature is over 100°C, the NoWater LED turn ON. This is a ALERT message to avoid heating the HEATER element over dangerous temperature; and Heater test cannot be performed.		ON		

Press the Coffee button to switch on the Grinder

Action by user	LED INDICATION			
	Led NoBeans	Led NoWater	Led GenAlarm	Led Dreg
	BLINK	NA	OFF	NA
The grinder rotates and Led NoBeans Blink every grinder pulses.	BLINK	NA	OFF	NA
ERROR: the led NoBeans remains OFF and after the led NoBeans switch ON; check the hall sensor board in the Grinder, the wiring from the hall sensor board to the CPU/POWER board (JP2) and the wiring from the Grinder to the CPU/POWER board (JP8)	ON	NA	OFF	NA

Finish condition: With BU, Drag Drawer, door closed	LED INDICATION			
	Led NoBeans	Led NoWater	Led GenAlarm	Led Dreg
	OFF	OFF	OFF	OFF

5.6.2. SteamOut

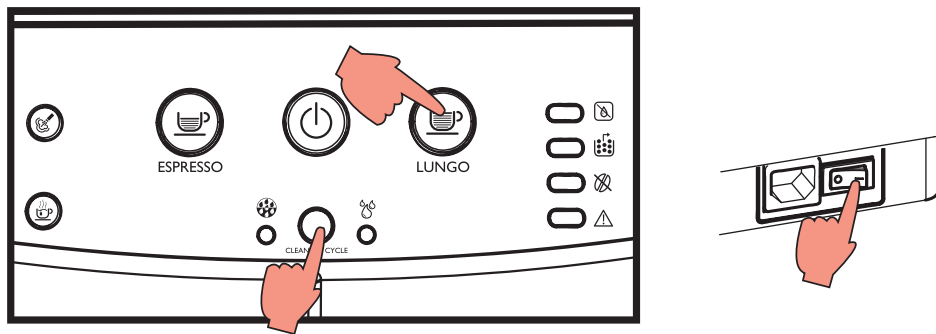

To enter in SteamOut

The machine enters SteamOut mode by holding pressed together the **COFFEE** button and the **CALC_CLEAN** button while switching on the machine.

Once entered shows Led Descale and Led Rinsing flashing in series.

If Door is opened or drag drawer is removed LED WASTE FULL will be switched on.

At the end of procedure Brewing Unit will be moved to rest position and LED ESPRESSO and LED COFFEE turns on.

When the Steam-Out is complete the following parameters are reset to their default values:

- Length Espresso product
- Length Coffee product
- StandBy Time
- Count Coffee
- The request for Priming the Circuit at the first switch on is set.
- Aroma
- Aroma Impulses
- Filter Presence
- Filter Pulses
- Dynamic threshold
- History of grindings for Beans Presence detection

5.7. Error codes

ERROR CODES	DESCRIPTION
01	The coffee grinder is blocked (grinder blades jammed or sensor not reading properly)
03	The brewing unit is blocked in work position (microswitch not released in up position after 3", torque error trying to move down, descent time out exceeded)
04	The brewing unit is blocked in home position (microswitch not released in down position after 3", torque error trying to move up, ascent time out exceeded)
05	Water circuit / flow meter problems (water circuit blocked or no flow meter signal)
10	Boiler temperature sensor short circuited
11	Boiler temperature sensor open circuit
14	The boiler temperature has exceeded the maximum allowed value (165°C)
15	The boiler temperature has not increased by x°C in y sec (boiler power supply disconnected, incorrect boiler fitted must be a 1300W boiler, partial power supply to boiler, cut out thermostat tripped)
19	Mains voltage trouble
22	interface missing or unknown



CHAPTER 6

STANDARD CHECKS

6.1. Repair schedule

	Action
1	Visual inspection (transport damage)
2	Machine data check (rating plate)
3	Operational check / problem analysis
4	Opening machine
5	Visual inspection
6	Operational tests
7	Repairing the faults encountered
8	Checking any modifications (view Symptom Cure, new software, etc.)
9	Service activities in accordance with the operating schedule
10	Internal cleaning
11	Operational test while the appliance is open
12	Assembly
13	Final inspection test
14	Draining the circuit (in winter)
15	External cleaning
16	Lubricating the brewing unit with suitable grease
17	Insulation test HG 701 (dielectric)
18	Documentation

6.2. Service schedule

S	Replacement
ES	Visual inspection
D	Descaling

P	Cleaning
TR	Noise test
R	Adjustment

Component	Action	Support/tool
Water filter	P/S	
Water tank lip seal	S	
Boiler pin O-ring	S	
Brewing unit	ES/P	Grease solvent / Grease
Hoses, attachments and Oetiker clamps	ES	
Pump	ES/TR	
Gear motor	ES/TR	
Coffee grinder	P/R	Vacuum cleaner / brush
Water circuit	D	Saeco descaler
Hot water/steam valve	ES/S	

6.3. Final test

Test	Procedure	Support/ tool	Standard	Tolerance
Espresso	2-3 Espressos for adjustment purposes	Measuring scoop	Same amount	15%
Coffee	2-3 Coffees for adjustment purposes	Measuring scoop	Same amount	15%
Noise			Standard	
Amount of cream	Blow into the cup until the cream separates		The cream should come together again to form a complete layer	
Cream colour			Hazel brown	
Temperature	Reading taken while dispensing	Thermometer	84 °C	± 4 °C
Grinding level	Check the grain size of the ground coffee			
Hot water	Dispense water			
Steam	Dispense steam			
Dreg drawer missing indication	Remove the dreg drawer		Dreg drawer missing indication	
Low bean level indication	Start brewing a coffee while the coffee bean hopper is empty		Low bean level indication	



CHAPTER 7

DISASSEMBLY

7.1. Outer Shell



Remove the water tank, coffee container cover, drip tray, dreg drawer, brewing unit.

Coffee dispenser Minuto

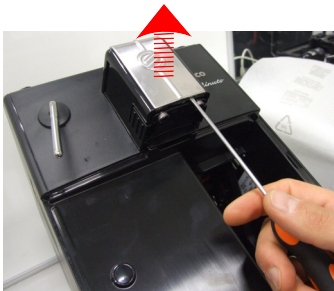

Remove the dispenser cover



Unscrew the screws shown and remove the dispenser



Unscrew the screws and proceed as illustrated in the following pages.

exploded view of the coffee dispenser

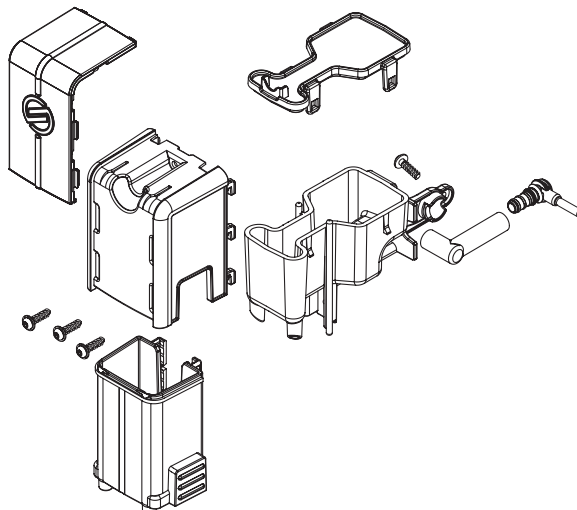

Coffee dispenser Minuto for USA

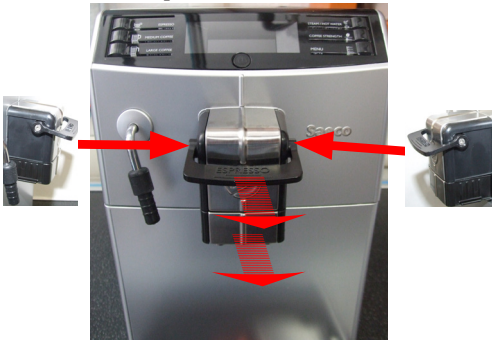

Remove the lower dispenser and unscrew the screws shown for remove the lever

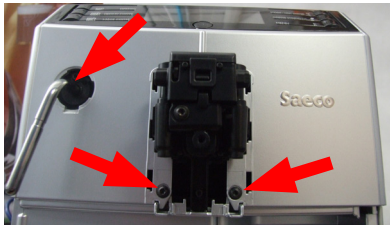

Unscrew the screws and proceed as illustrated below.



Remove the cover

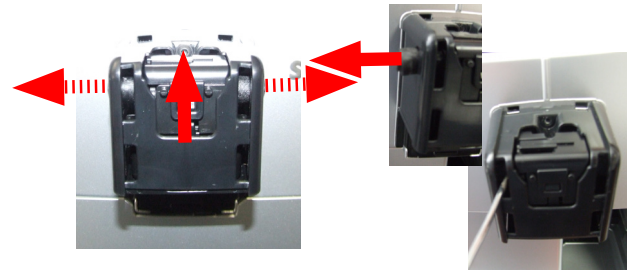

Unscrew the screw shown and remove the inserts with a screwdriver

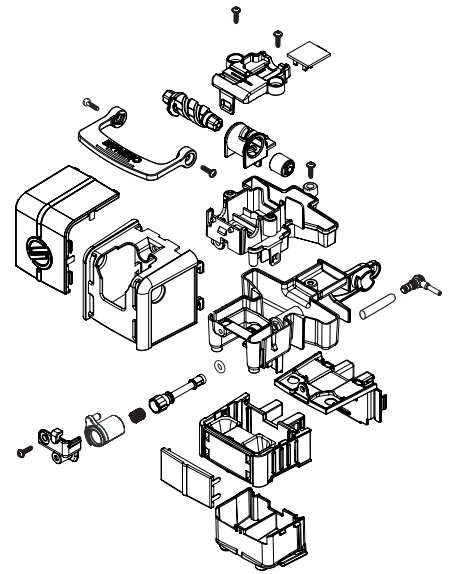

exploded view of the coffee dispenser



Remove the steam pipe cover as picture and unscrew the screw shown.

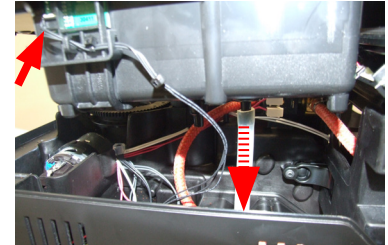
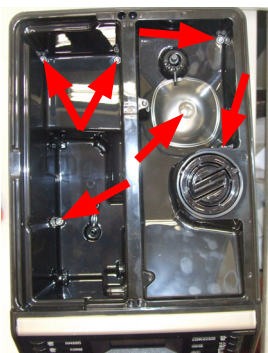

Unscrew the screws shown, raise the top cover and remove the electrical and water circuit connections.

7.2. Coffee grinder



Raise the coffee grinder and remove the connections.

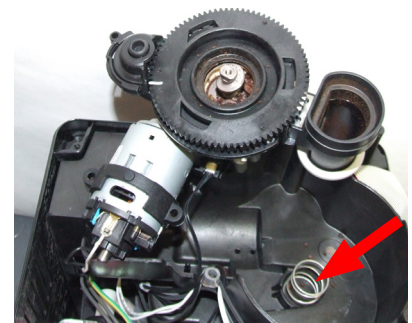
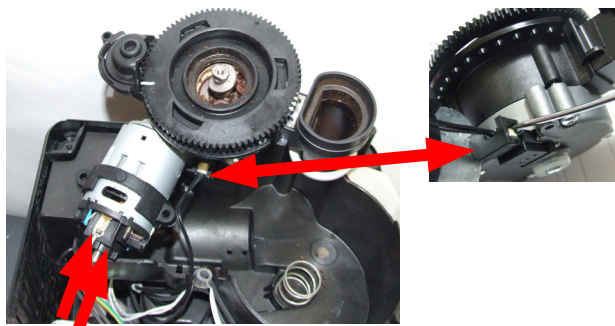

When reassembling the coffee grinder, make sure the spring is repositioned correctly (see photo).

7.3. Grinder blades

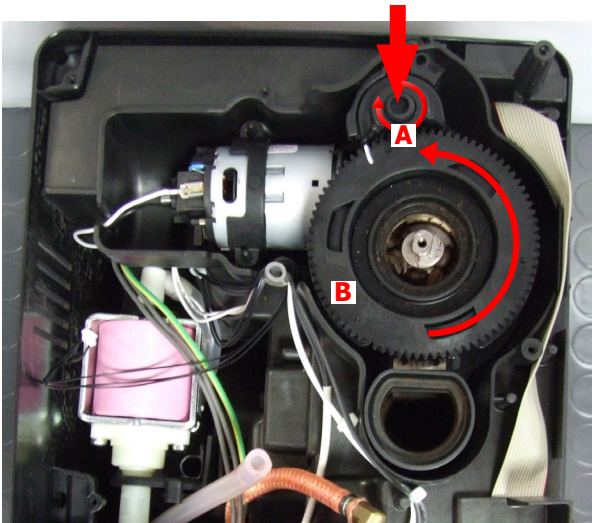

To extract the top support of the appliance, press on the grinding adjustment spindle (A) and turn the support anticlockwise until it unhooks.

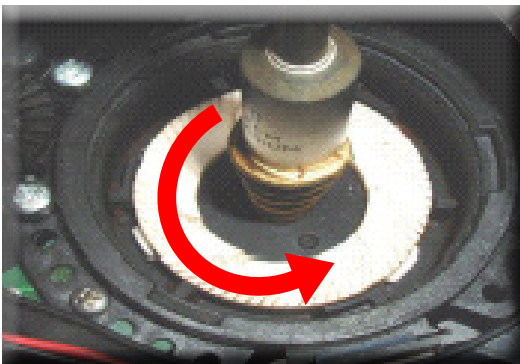

Turn the grinder blades anticlockwise out of the support.

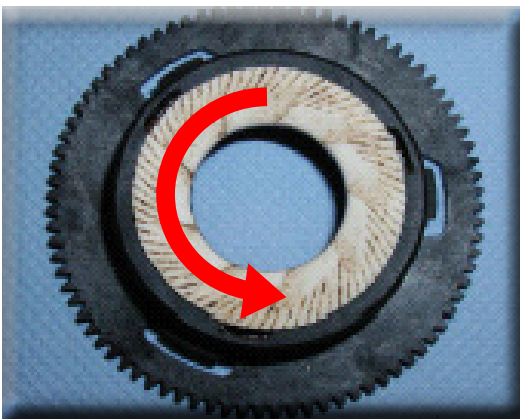

Turn the grinder blades clockwise out of the support. The bayonet connections can be accessed from the rear.

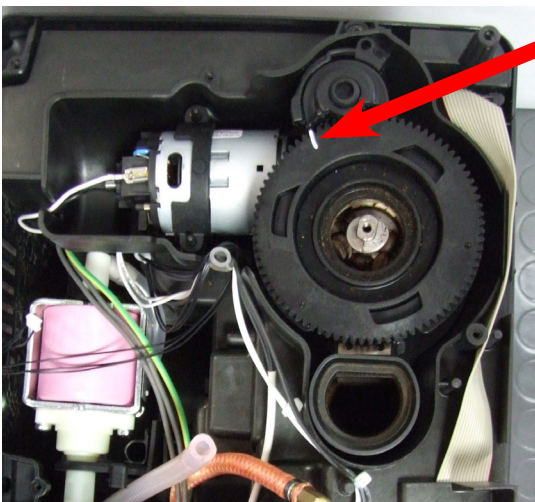

For a standard adjustment, both markings must be aligned.

7.4. Coffee grinder adjustment

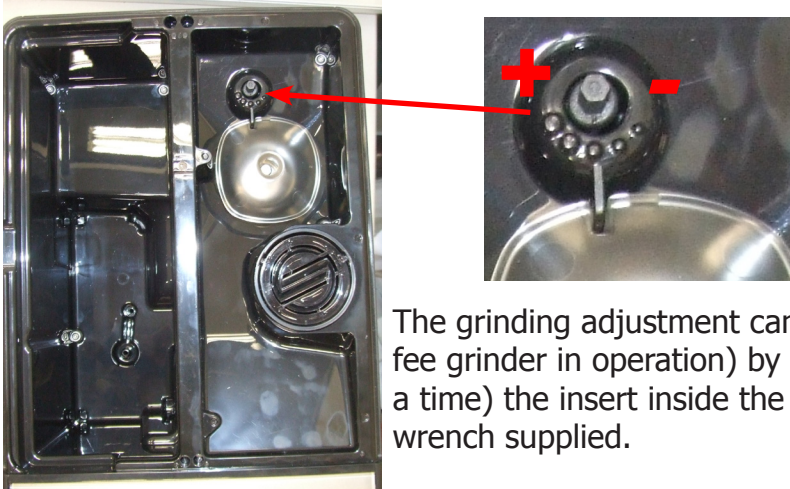

The grinding adjustment can be set by the user (only with the coffee grinder in operation) by pressing and turning (only by one click at a time) the insert inside the coffee bean hopper with the aid of the wrench supplied.

Adjustment by a service center

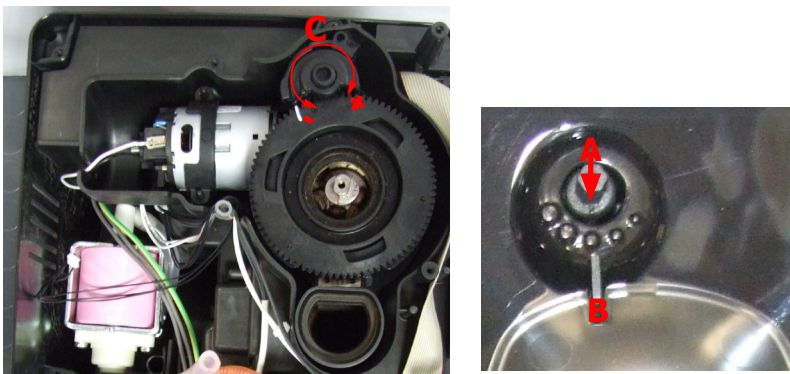

To adjust grinding further, the engineer can work directly on the coffee grinder by pressing and turning the ring nut (C) shown. (clockwise + to increase the particle size of the coffee and anticlockwise - to decrease it).

If there are any remains of coffee powder between the two grinding blades it is recommended to tighten by max. two marks at a time.

Lastly, move the arrow (A) on the adjustment knob to the center of the adjustment dots on the cover (B).

7.5.1 Two-way solenoid valve



Remove the board support assembly and disconnect the electric connection

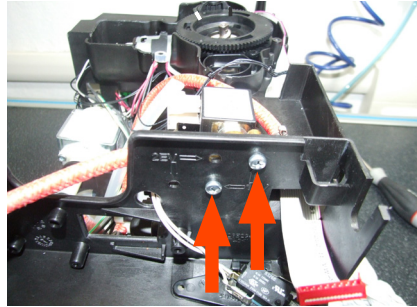

Loosen the screws holding the solenoid valve to the upper plate

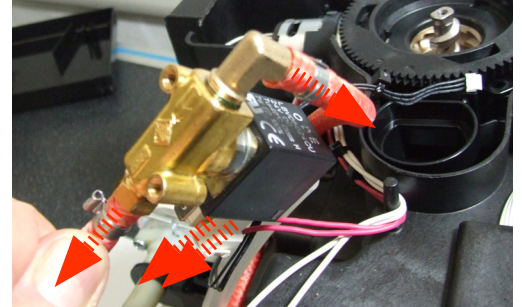

Disconnect all electrical and water circuit connections

Two-way solenoid valve in Minuto Cappuccino

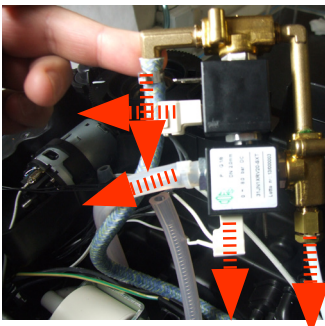

Disconnect all electrical and water circuit connections

7.5.2 Carafe connection and hot water dispenser in Minuto Cappuccino

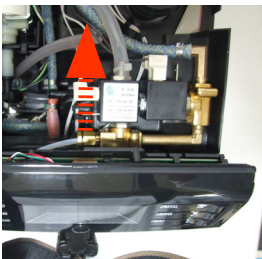

Slide out the fork as illustrated

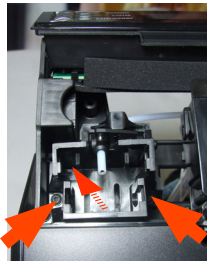

Loosen the screws holding the carafe connection

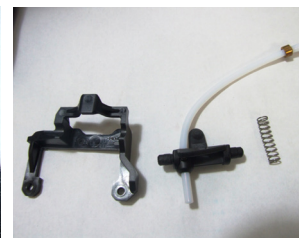

When reassembling the assembly to be careful to correctly position the spring.

7.6. Pin boiler

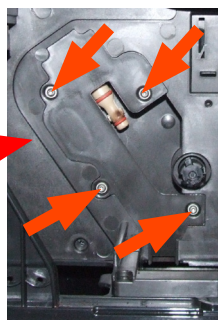
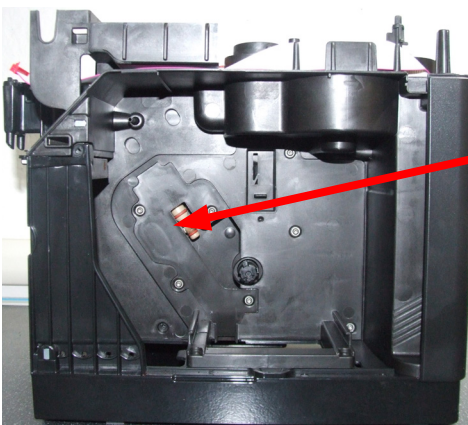

Loosen the screws as illustrated and remove the boiler pin (A).

7.7. Gear motor

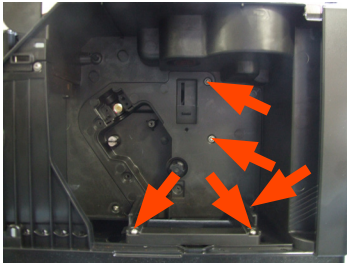

Loosen the screws as illustrated and remove the gear motor cover.

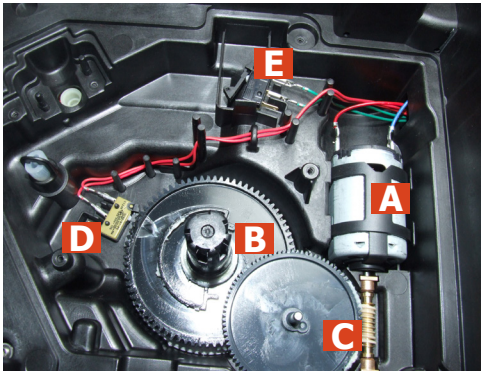

The following are located inside the compartment protected by the casing:

- Electric motor (A) with gears (B) and (C) for transmission and timing of the dispenser.
- Brewing unit present microswitch (E).
- Microswitch (D) detecting brewing unit home and work positions.
- Remove the gear (C) that meshes with the motor transmission shaft.
- Remove the large gear (B).
- Remove the motor (A), complete with transmission shaft.

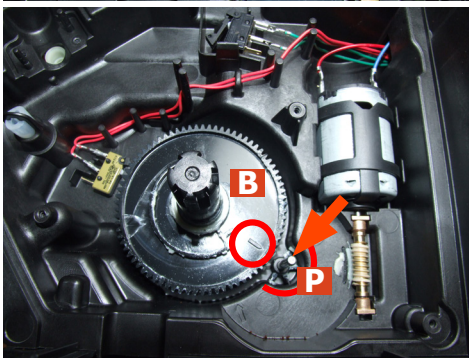

Replace the gear (B), making sure that the imprint of the arrow is aligned with the opening containing the pin (P).

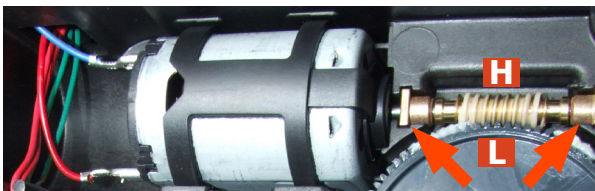

When replacing the motor and the transmission shaft, make sure the guide runners (L) are in the right position.

Grease the shaft thoroughly and evenly.

7.8. Central plate

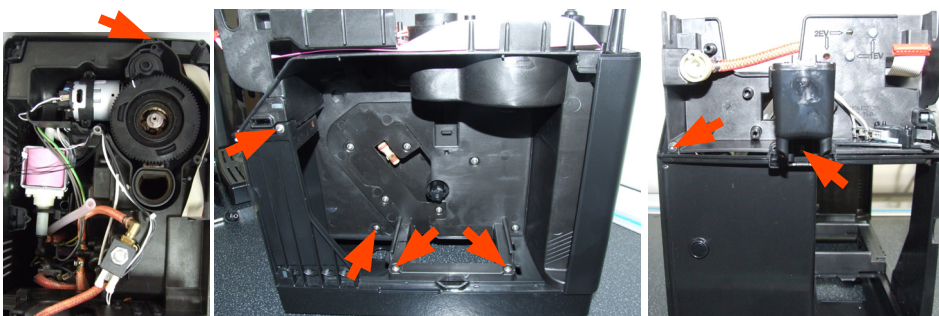

unscrew the screws shown



Lift up the center plate

7.9. Pump

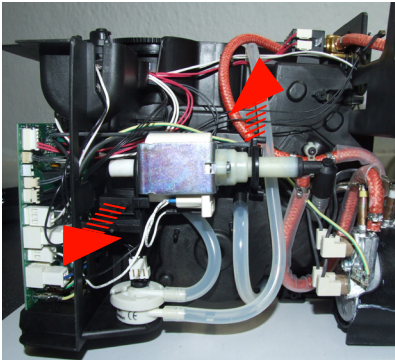

Unhook the pump from the supports.

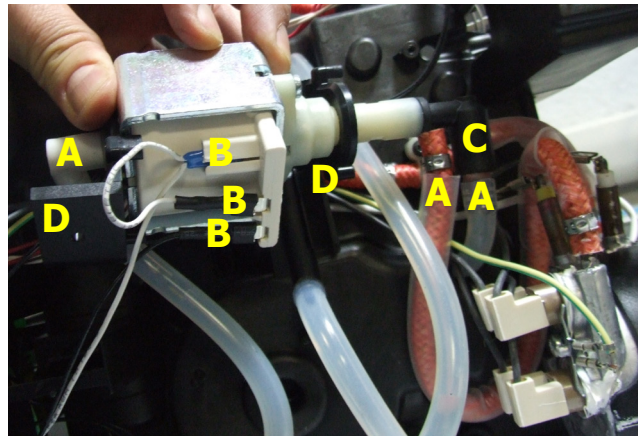

Disconnect the water circuit connections (A) and electrical connections (B), loosen the safety valve (C) and slide the pump off the brackets (D).

7.10. Flow-meter

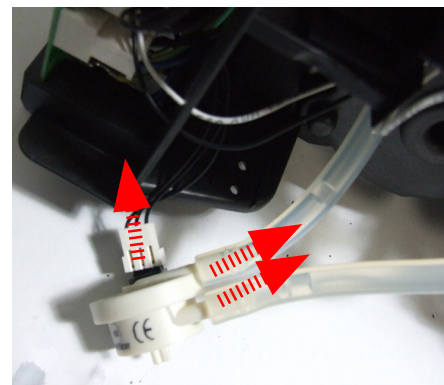
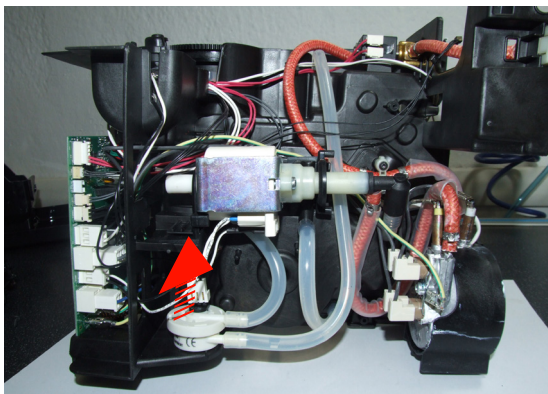

Lift the flow meter out of the casing assembly and remove the electrical and water circuit connections.

7.11. Boiler

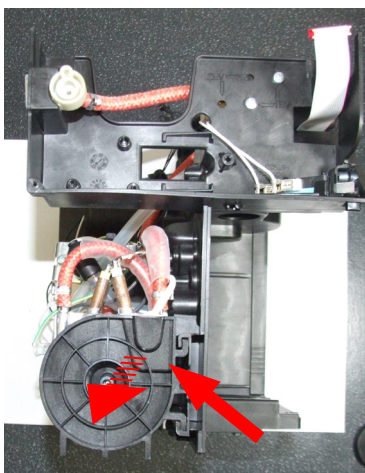

Unscrew the screw shown at unthread the support boiler

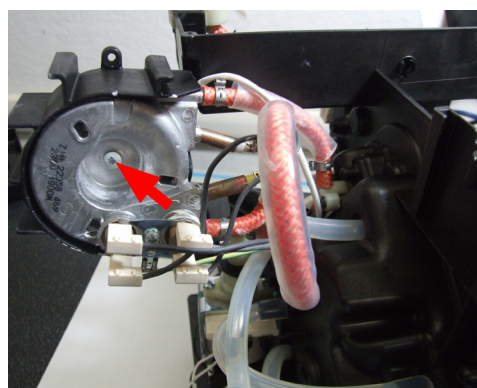

Unscrew the screw shown and remove the electrical and water circuit connections.

7.12. CPU board

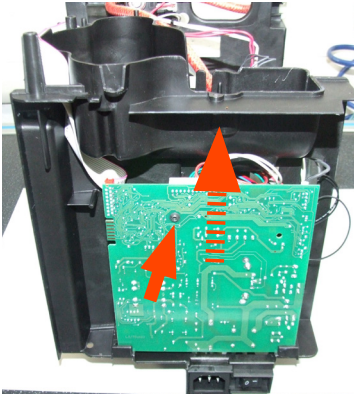

Loosen the screws slide the card off the support and disconnect the electrical connections.

7.13. Programming access for SSC (Saeco Service Center)

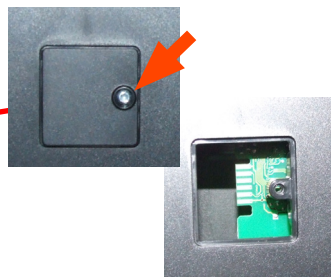

Loosen the screw for remove the cover.

7.14. KYB interface and display

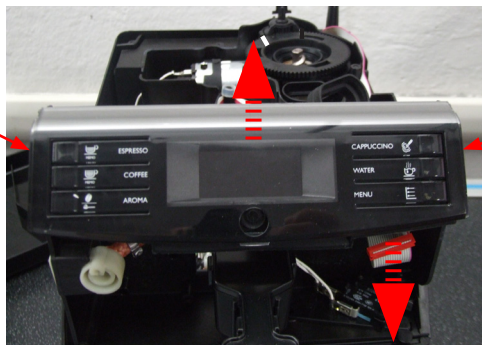
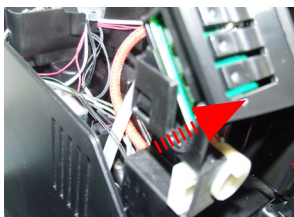

Disconnect the electrical connections. Press to right and left and lift the assembly KYB

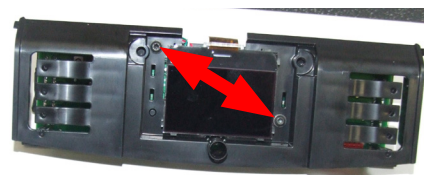

Loosen the screws for remove the cover.

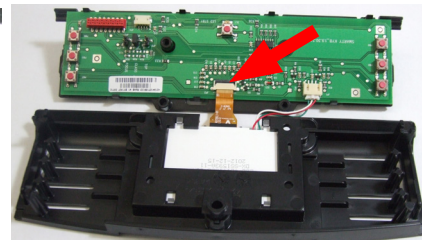

Disconnect the electrical connections.

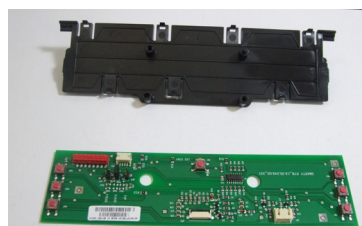
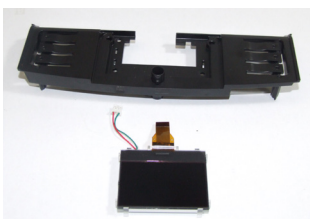

7.15. Fitting and removing Oetiker clamps

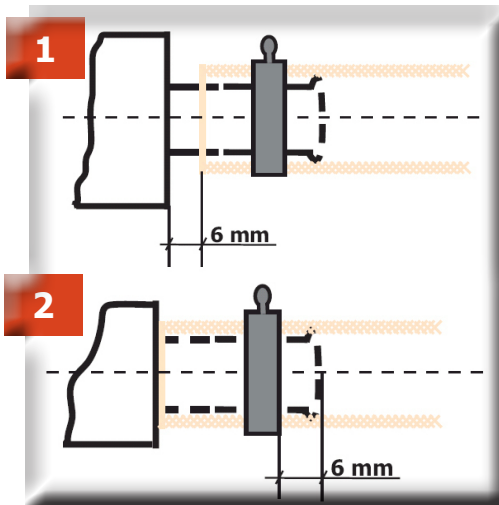

1) Boiler connection.

2) Other connections.

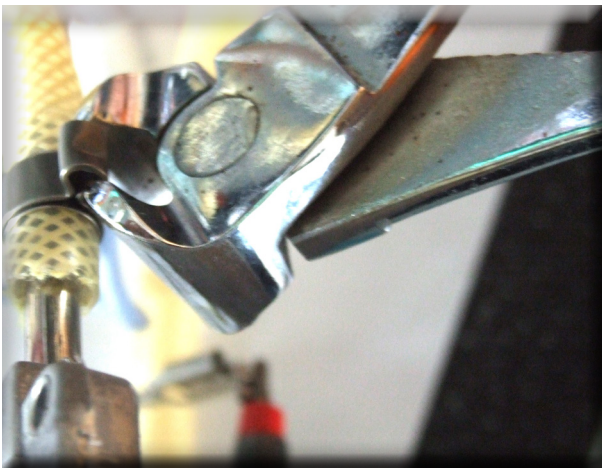

Use a suitable pair of pliers to remove the clamp (as illustrated).



Tighten the clamp as illustrated.



CHAPTER 8

NOTES



CHAPTER 9

WATER CIRCUIT DIAGRAM

Minuto Cappuccino

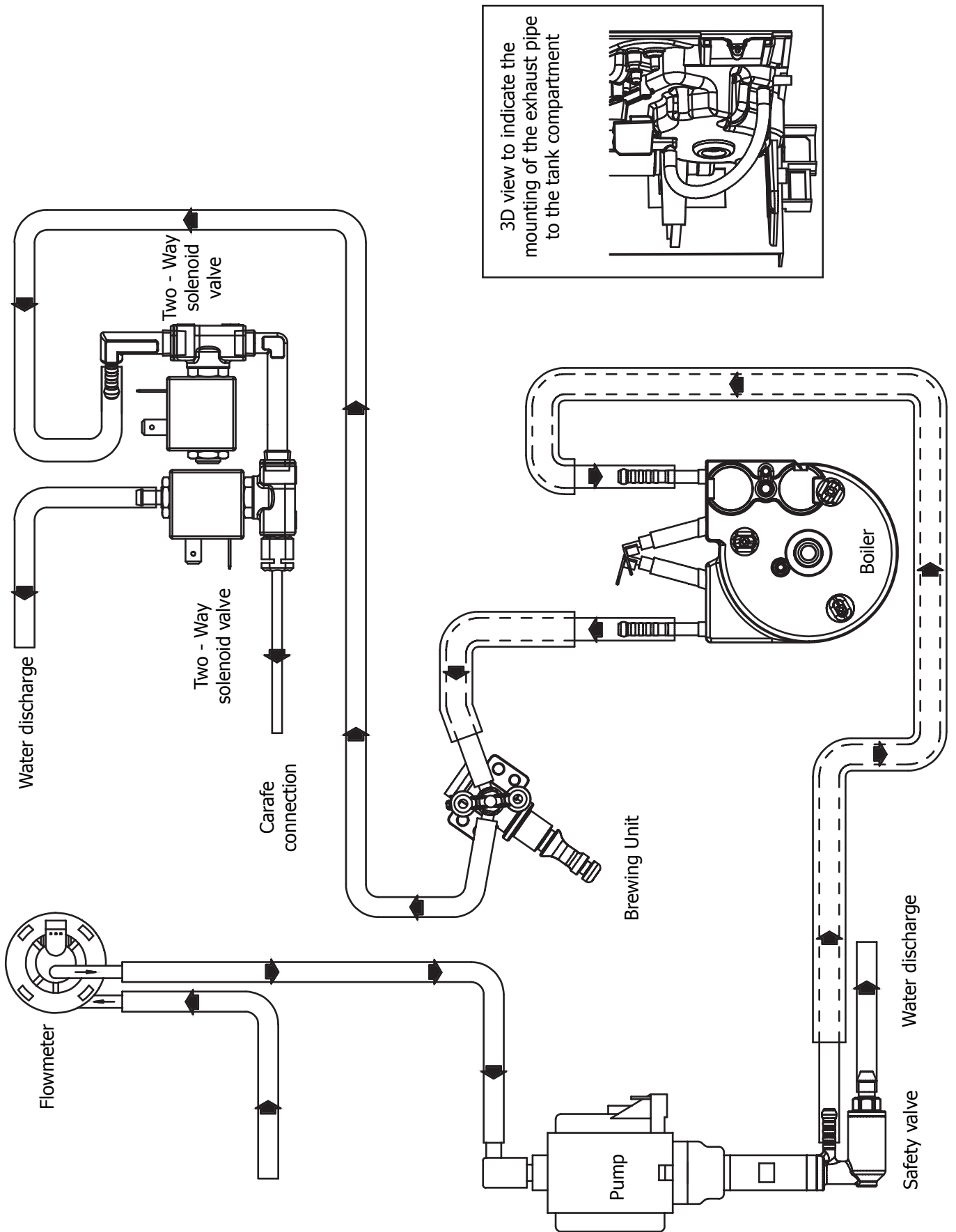

Minuto Focus and Class

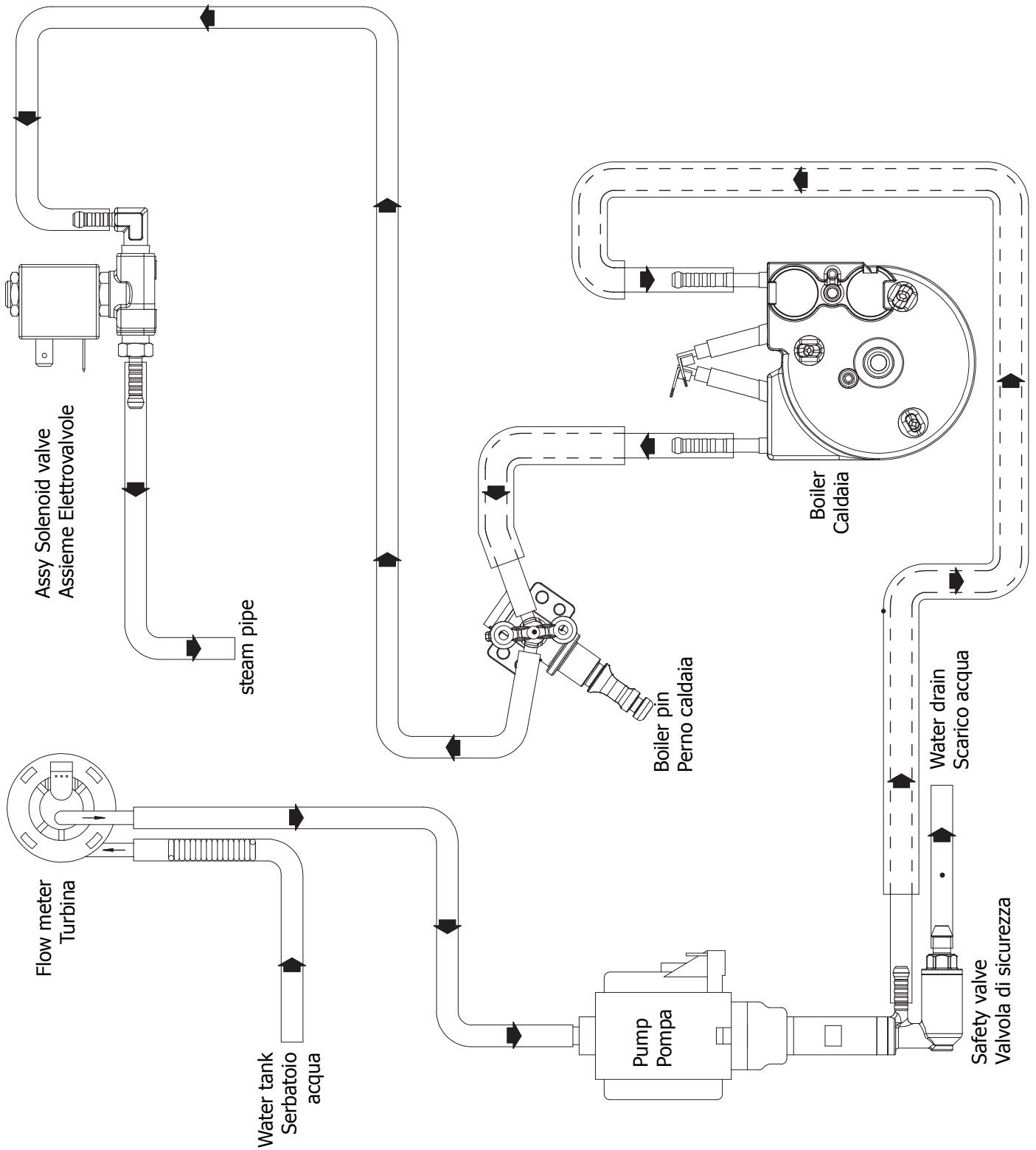



CHAPTER 10

ELECTRICAL DIAGRAM

Minuto Cappuccino Focus and Class

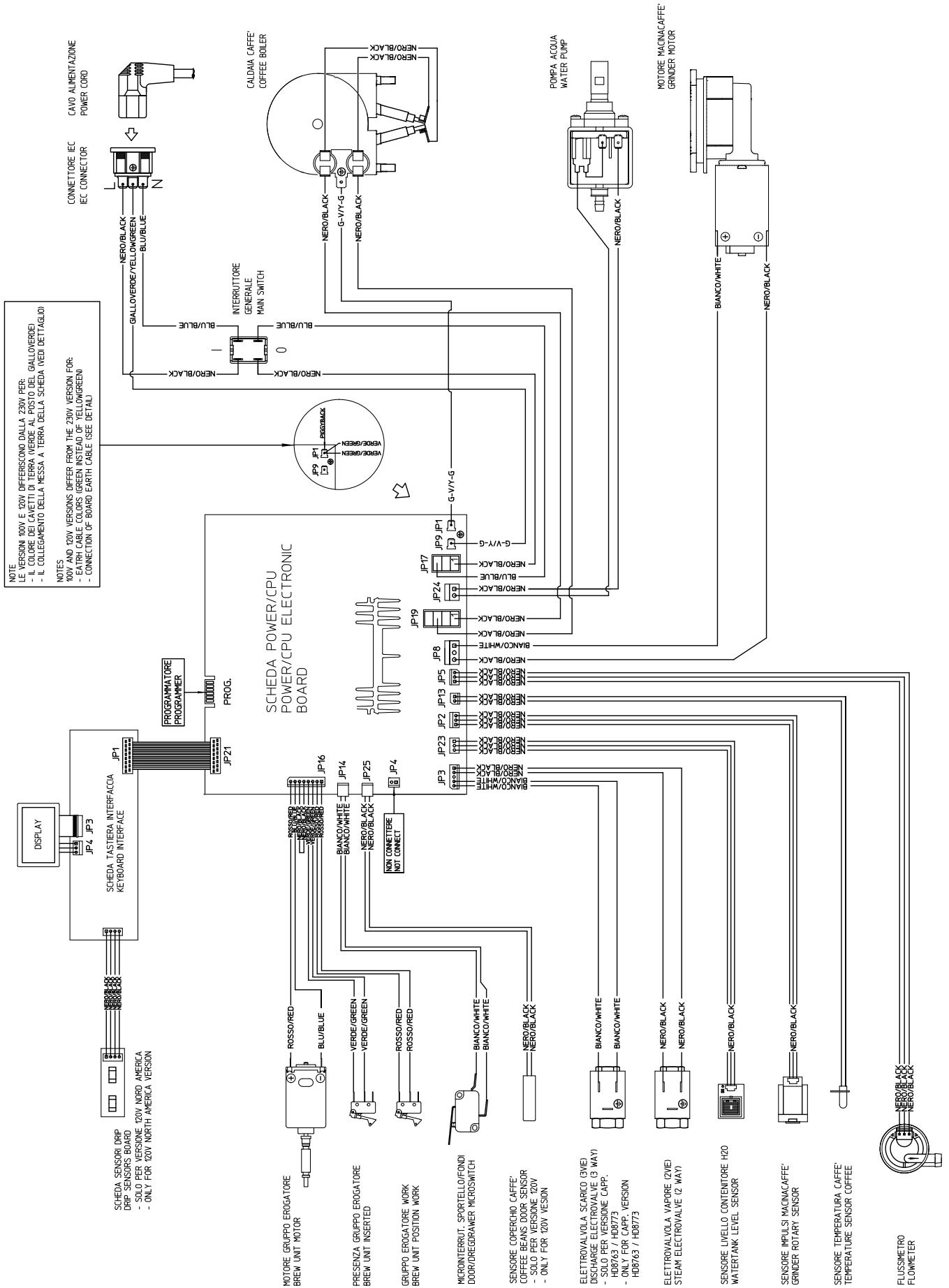

Minuto Pure

