

SYNTIA

SERVICE MANUAL

Revision 02 December 2012

**All parts of this document are the property of Saeco International Group.
All rights reserved. This document and all the information herein is provided without liability deriving from any errors or omissions. Furthermore, no part may be reproduced, used or collected, except where express authorisation has been provided in writing or through a contractual agreement.**

Table of contents

	Page
1. Introduction	
1.1 Documentation required	1
1.2 Tools and equipment required	1
1.3 Material	1
1.4 Safety warnings	1
1.5 Service Policy	2
1.6.1 External machine parts	3
1.6.2 Internal machine parts	4
2. Technical specifications	
2.1 Technical specifications	1
2.2 Specification for the measurement of the coffee products temperature	2
2.2 Machine parameters and performance	3
3. Brief instructions Rev.01	
3.1.1 Customer menu and Digital programming	1
3.1.2 Customer menu and Focus programming	5
3.2 Operation, cleaning and maintenance	7
4. Operating logic	
4.1. Water circuit	1
4.2 Control ringnut and valve	2
4.3 Coffee cycle operating diagram	3
4.4 Single microswitch	4
4.5 Temperature sensor	4
4.6 Coffee grinder operation	5
4.7 Low bean level detection, dose quantity adjustment, coffee grinder blocked	5
4.8 Dose self-learning	6

Table of contents

	Page
5. Service mode Rev.01	
5.1.1 Digital test mode	1
5.1.2 Focus test mode	5
5.2. Error codes	7
6. Service & Maintenance	
6.1 Repair schedule	1
6.2 Service schedule	1
6.3 Final test	2
7. Disassembly Rev.01	
7.1 Outer elements disassembly	1
7.2 Coffee spout disassembly	2
7.3.1 Disassembling keypad card and Digital control knob	3
7.3.2 Disassembling keypad card and Focus control knob	3
7.4 Power/CPU card disassembly	4
7.5 Gearmotor disassembly	4
7.6 Boiler disassembly	5
7.7 Valve disassembly	5
7.8 Pump and turbine disassembly	6
7.9 OETIKER clamps assembly and disassembly	7
7.10 Coffee grinder disassembly	8
7.11 Grinder adjustment / assembly and disassembly	9
8. Notes	
9. Water circuit diagram	
9.1. Water circuit diagram	
10. Electrical diagram	
10.1 Digital wiring diagram	
10.2 Focus wiring diagram	

CHAPTER 1

INTRODUCTION

1.1 Documentation required

The following documentation is needed for repair procedures:

- Instruction booklet for specific model
- Technical documentation for specific model (diagrams, exploded view, symptom cure and service manual)

1.2 Tools and resources

As well as the standard equipment, the following is required:

Qty.	Description	Notes
1	Screwdriver	Torx T 10
1	Pliers for Oetiker clamps	
1	CC -A - Vdc tester	
1	Digital thermometer	Scale limit > 150°C
1	SSC (Saeco Service Center)	Programmer

1.3 Material

Description	Notes
Thermal paste	Heating element > 200°C
Descaler	Saeco Entkalker
Grease solvent	Personal preference
Silicone grease	Safe to use with food

1.4 Safety warnings

We recommend you consult this Service Manual of the machine before performing any maintenance work.

Observe all applicable standards relating to the repair of electrical appliances.

Always disconnect the power plug from the mains before beginning repair work.

Simply turning off the main machine power switch is not an adequate safety precaution.

This appliance is rated as protection class I.

Insulation and dielectric rigidity tests must be performed on completion of any repair.

1.5 Service POLICY grid as used for coffee machine

For IN WARRANTY repairs is mandatory to use the single components (not the assembly) available in the exploded views of the coffee machines or of the specific components. If you find the information "SEE THE EXPLODED VIEW E....." in the assembly description field, it means that the single components of the assembly are available in the other pages of the exploded view. It's possible to use the assembly only if there is a specific Symptom Cure that include this possibility or when the single components are not available for the order.

List of principal assembly present in all our coffee machines

Components	Assembly use	Single components available
COFFEE GRINDER	<u>Only for OOW repairs</u>	YES , to consult the specific exploded-view of the machine or of the Coffee Grinder on website
BREWING UNIT	<u>Only for OOW repairs</u>	YES , to consult the specific exploded-view of the machine or of the Brewing unit on website
BOILER	<u>Only for OOW repairs</u>	YES , to consult the specific exploded-view of the machine on website
GEAR MOTOR	<u>Only for OOW repairs</u>	YES , to consult the specific exploded-view of the machine on website
FILTER HOLDER	<u>Only for OOW repairs</u>	YES , to consult the specific exploded-view of the machine on website
MILK CARAFE	<u>Only for OOW repairs</u>	YES , to consult the specific exploded-view of the machine on website
THERMAL CARAFE	<u>Only for OOW repairs</u>	YES , to consult the specific exploded-view of the Thermal Carafe on website
MILK ISLAND	<u>Only for OOW repairs</u>	YES , to consult the specific exploded-view of the Milk Island on website

1.6.1 External machine parts

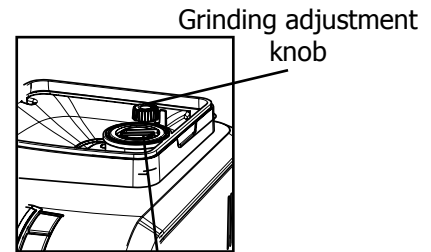
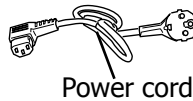
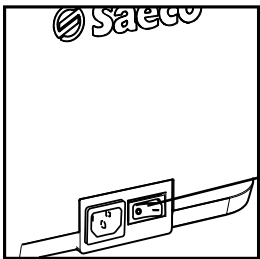
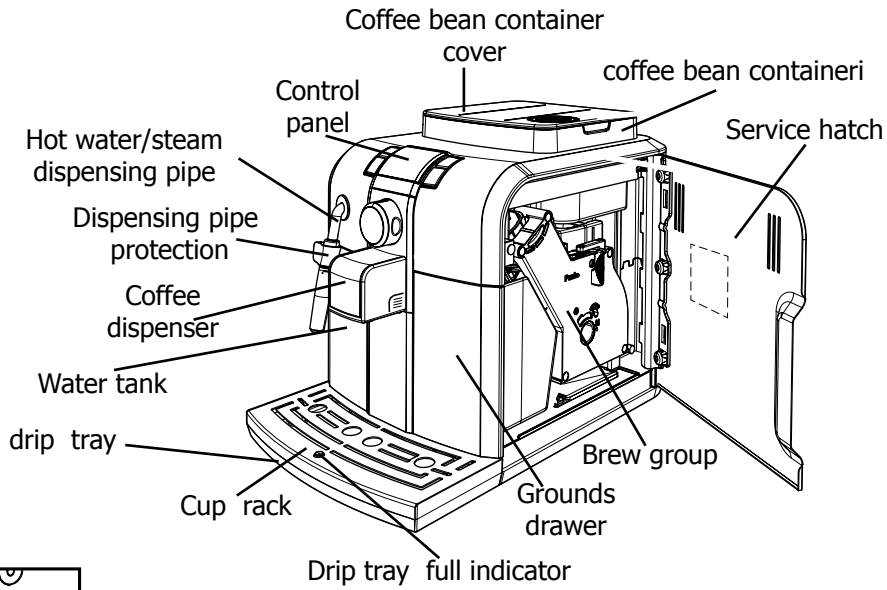

Pre-ground coffee compartment

DGT

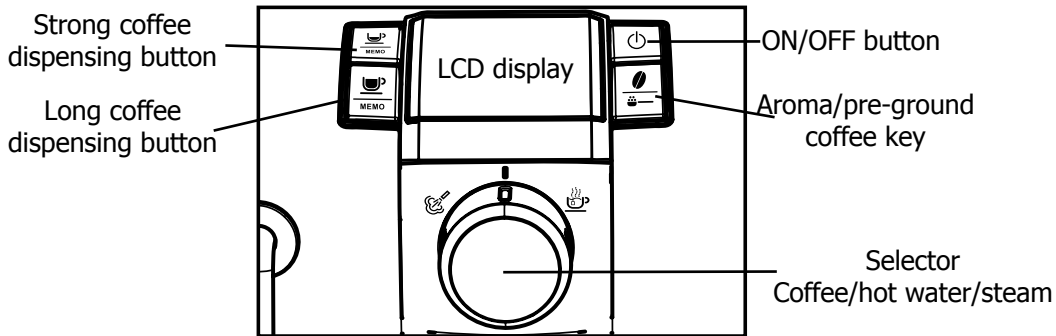

FOCUS

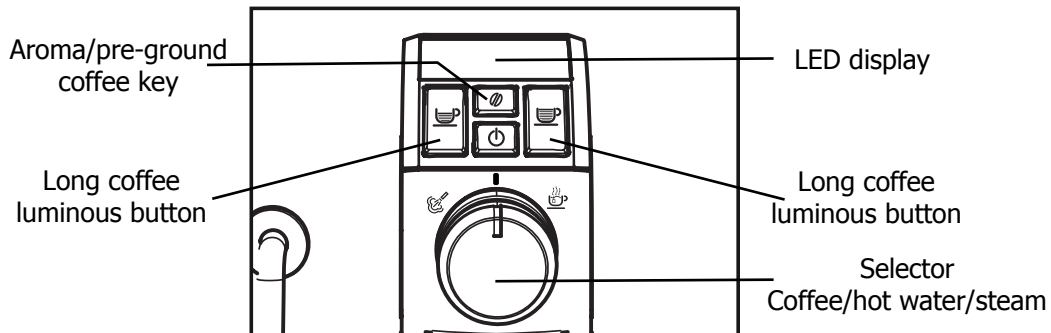

1.6.2 Internal machine parts

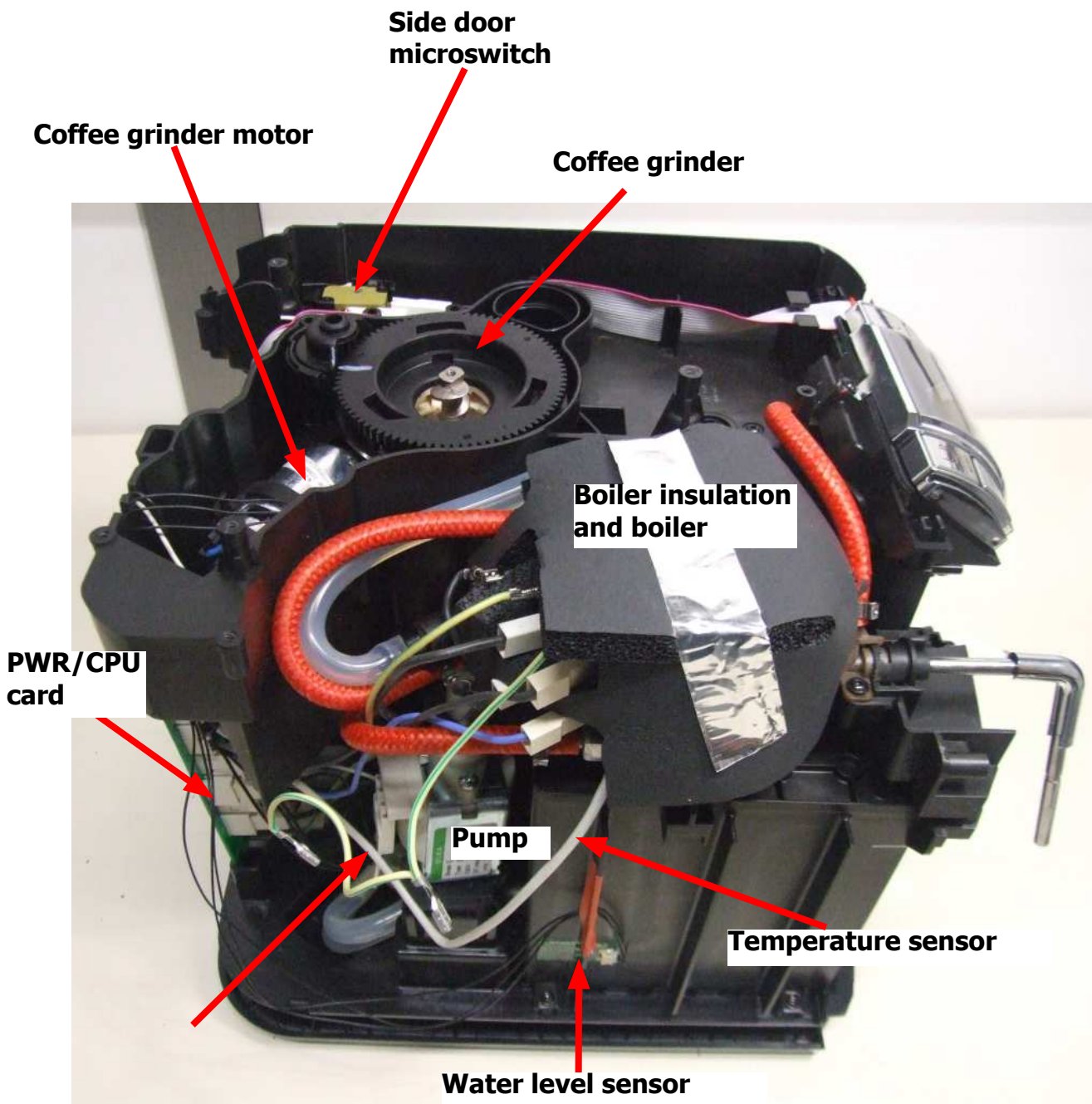

CHAPTER 2

TECHNICAL SPECIFICATIONS

2.1. Technical specifications

Power supply and output:	240 V~ 50 Hz 1400 W - 230 V~ 50/60 Hz 1400 W - 120 V~ 60 Hz 1500 W - 100 V~ 50/60 Hz 1300 W
Temperature monitoring:	Variable resistor sensor (NTC) - transmits the value to the electronic P.C.B
Safety system:	2 manual reset or one-shot thermostats (175°C)
Coffee heat exchanger output: Stainless steel	(230/120 V~) 1300 W – (100 V~) 1100W for coffee, hot water and steam dispensing
Gear motor:	33VC with 2 rotation directions; power supply 24VC
Pump:	Ulka with reciprocating piston and 120°C cutout 48 W, 230V, 50 Hz, Type EP5 approx. 13-15 bar 120V, 60Hz 100V, 50/60 Hz
Overpressure valve:	Opens at approx. 16-18 bar
Water filter:	In tank
Coffee grinder:	Direct current motor with flat ceramic grinders
Hot water/steam valve	Presblock
Automatic dosage	Dose adjustment controlled by the electronic system
Power consumption:	During the heating phase - approx. 5.6 A
Dimensions: W x H x D in mm:	256x315x410
Weight:	9 kg
Water tank capacity:	1l.
Coffee container capacity	200 gr. coffee beans
Dregs drawer capacity	8
Heat exchanger capacity:	Approx. 10 cc
Water circuit filling time:	Approx. 15 seconds for first filling cycle
Heating time:	Approx. 45 seconds.
Grinding time:	Approx. 8-10 seconds.

2.2. Specification for the measurement of the coffee products temperature.

The temperature is influenced by the flow from the dispenser and stratification of temperatures in the glass. In order to consider these phenomena and to introduce measures that allow comparisons in controlled conditions, below guidelines must be followed:

Conditions:

- a) Water temperature in tank: 23°C (+/-2°C).
- b) It must be used a plastic cup (see picture N°1).
- c) It must be used a thermocouple thermometer (e.g. type K - see picture N°2).
- d) The coffee machine is tested without any change of parameters or calibrations, which may affect the temperature of products, so the measurement of temperature must be done with machine in default factory setting.

Procedure:

1. The temperature must be measured in the cup, immediately after dispensing. Cup has to be placed on a non-metal surface using a thermocouple thermometer.
2. The temperature in the cup is measured by immersing the probe of the thermometer up to touch the bottom. The probe then must be moved in a circular motion for 5/6 rotations. At the of the rotations, stop in the center of the cup.
3. The highest temperature measured during the rotations is the value we are searching for, and that must be reported;
4. Test measurement: from end of dispensing to the end of rotations must be completed within 12 seconds.

Limits of acceptability

The acceptance limits are divided by features and products and are the following:

Espresso Coffee Italy Q.ty 25/40 gr.

Temperature of 1st product 69°C ≤ 85°C

Temperature of 2nd product 72°C ≤ 85°C

Coffee Q.ty 70/120 gr.

Temperature of 1st product 69°C ≤ 85°C

Temperature of 2nd product 72°C ≤ 85°C



2.3. Machine parameters and performance

PRODUCT QUANTITY	Minimum amount (Puls.)	Default amount (Puls.)	Maximum amount (Puls.)	Programm. by the user	Programm. by Production / Service
Espresso	70	165	600	Yes	No
Medium coffee	No	No	No	No	No
Long coffee	70	440	600	Yes	No
Pre-ground	Yes				
Hot water	Continues until the water supply has been exhausted (capacitive sensor)				
Steam for frother	Continues until the water supply has been exhausted (capacitive sensor)				

RINSE	Initial rinse	Final rinse
When performed	At coffee machine activation when the boiler temperature is $\leq 50^{\circ}\text{C}$	When the machine is switched off electronically, manually or automatically after 60', if at least one coffee has been dispensed, before switching off
No. of pulses	180	80
Stopping option	Yes, by pressing any key	Yes, by pressing any key
User disable option	No	No
Production/Service department disable option	No	No
No. of pulses user adjustment option	No	No
No. of pulses Production/Service department adjustment option	No	No
Pulse range (Min - Max)	No	No

WATER HARDNESS	CANNOT BE SET
----------------	---------------

DREGS DRAWER	Description and values
Time-out for dregs drawer	5 sec.
Empty dregs drawer alarm after (double coffee is the last product dispensed)	8 lots of dregs (9 lots of dregs)
Warning to empty dregs drawer after	No
Reset dregs counter	Every time the dregs drawer is removed for at least 5 seconds, even if the "empty dregs" alarm has not been activated

POWER/OFF	Description and values
Inlet time (min. – max.)	60 minutes
Inlet time (default)	No
Inlet time prog. by the user	No
Inlet time prog. by Production/Service department	No

WATER TANK	Description
Level sensor	Yes
Water reserve (pulses) with water filter	200
Water reserve (pulses) with no water filter	200
Water reserve modifiable by Production/Service departments	No
"Fill tank" alarm	Yes
"No tray" alarm	No
Water mains	No

CHAPTER 3

BRIEF INSTRUCTIONS

Rev.01 February 2010



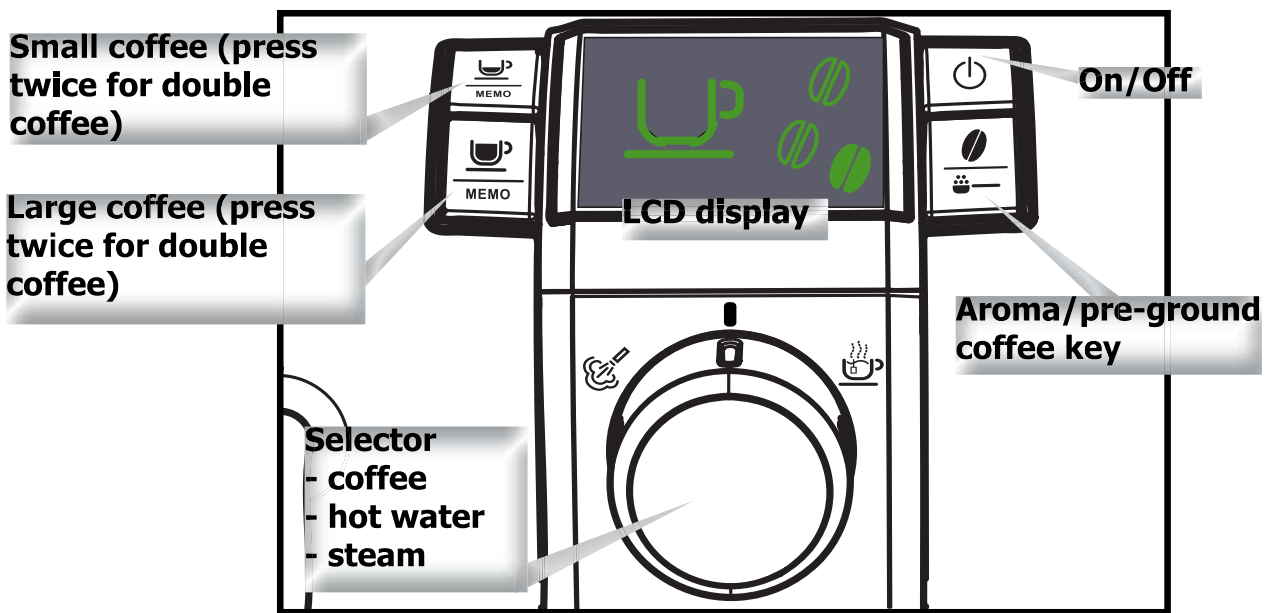



3.1. Customer and programming menu



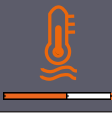





Machine ready signals (GREEN)







Indications	Causes	Solutions
	Machine at correct temperature - for coffee bean dispensing - for hot water dispensing	Proceed with the dispensing process
	Machine at correct temperature - for pre-ground coffee dispensing	Proceed with the dispensing process
	Machine dispensing steam	Proceed with steam dispensing
	Machine dispensing hot water	Proceed with hot water dispensing
	Machine dispensing one coffee	Wait for the dispensing process to end (dispensing stops when you press the key again)
	Machine dispensing two coffees	Wait for the dispensing process to end (dispensing stops when you press the key again)
	The machine is being programmed with the coffee cup fill level	Stop dispensing as desired



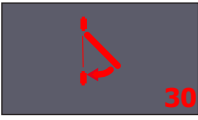





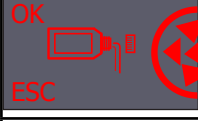

Notice signals (ORANGE)







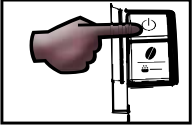

Indications	Causes	Solutions
	Machine in pre-heating phase for coffee, hot water and steam dispensing.	Wait until heated (see bar)
	The appliance is rinsing - wait until end of operation	Wait until end of operation
	The appliance requires a descaling cycle	Perform the descaling cycle To enter the descaling cycle press the aroma/pre-ground coffee key for 5 sec.
	Brewing unit resetting during appliance reset	Wait for reset
	Fill the coffee bean container and start the dispensing cycle	Fill the coffee bean container
	The machine requires replacement of the Intenza filter	Replace the filter. This message is displayed if the function is enabled by programming
		The alarm is disabled only if it is "RESET" by programming

Alarm signals (RED)

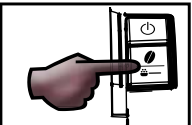
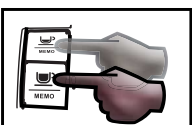
Indications	Causes	Solutions
	Switch the machine off, wait for 30 seconds and switch it back on again. Repeat 2 or 3 times.	If the machine does not start, remove brewing unit, clean it, grease it and re-insert. If the problem persist contact the Service Centre
	Water circuit fill request	Turn the knob to the cup 
	Circuit filling in progress	When the filling cycle ends turn the knob back to the central position 
	No coffee beans inside container.	After filling the coffee container, start the cycle again
	No water	Fill the water tank

Indications	Causes	Solutions
	Service door open: Close it. If the service door is opened while product is being dispensed, the appliance stops dispensing and starts a 30 sec. countdown before cancelling the dispensing process. The countdown can be stopped by closing the service door and operation will resume from its stopping point.	
	Turn the hot water/steam valve knob to the correct position. If the knob is turned (open) while product is being dispensed, the appliance stops dispensing and starts a 30 sec. countdown before cancelling the dispensing process. The countdown can be stopped by closing the knob and operation will resume from its stopping point.	
	No coffee unit. If the brewing unit is removed while product is being dispensed, the appliance stops dispensing and starts a 30 sec. countdown before cancelling the dispensing process. The countdown can be stopped by re-inserting the brewing unit and closing the door; operation will resume from its stopping point.	
	No dregs drawer. If the dregs drawer is removed while product is being dispensed, the appliance stops dispensing and starts a 30 sec. countdown before cancelling the dispensing process. The countdown can be stopped by re-inserting the dregs drawer and operation will resume from its stopping point.	
	Empty the dregs drawer	To reset the grounds counter, wait until there are no dregs displayed in the symbol (5 sec.)
	Insert dregs drawer	When the counter is cleared there will be no dregs displayed in the symbol

Indications	Causes	Solutions
DESCALING CYCLE (press the Aroma/pre-ground coffee key for 5 sec)		
	1) Pour the descaler into the water tank	 6) Open the hot water valve
	2) Open the hot water valve	 7) Rinsing in progress
	3) Descaling in progress	 8) Close the valve
	4) Close the valve	 9) Fill the tank with fresh water
	5) Fill the tank with fresh water	 10) Press the key indicated by the arrow

MENU (commands and programming)	
	You can go to the programming menu only in "Stand-by" mode Press the ON/OFF button to put the machine in Stand-by.
	Stand-by.
	When the machine is in Stand-by, press the button "☕ ⁻ " to go to programming, advancement between functions and memory
	The buttons "☕ ^{MEMO} " and "☕ ^{MEMO} " let you change the value of the function amongst those on the page.
	Coffee temperature: This function allows the coffee dispensing temperature to be adjusted
	Timer (Stand-by): This function lets you adjust the time for switching to Stand-by after the last dispensing.
	Contrast: This function allows the display contrast to be adjusted for better viewing of the messages.
	Water hardness: This function lets you adjust the water hardness so that machine maintenance is managed better ▲ = very soft water ▲▲ = soft ▲▲▲ = hard ▲▲▲▲ = very hard
	"INTENZA" water filter This function lets you manage the "INTENZA" water filter.
	Factory settings This function allows the factory values to be reset



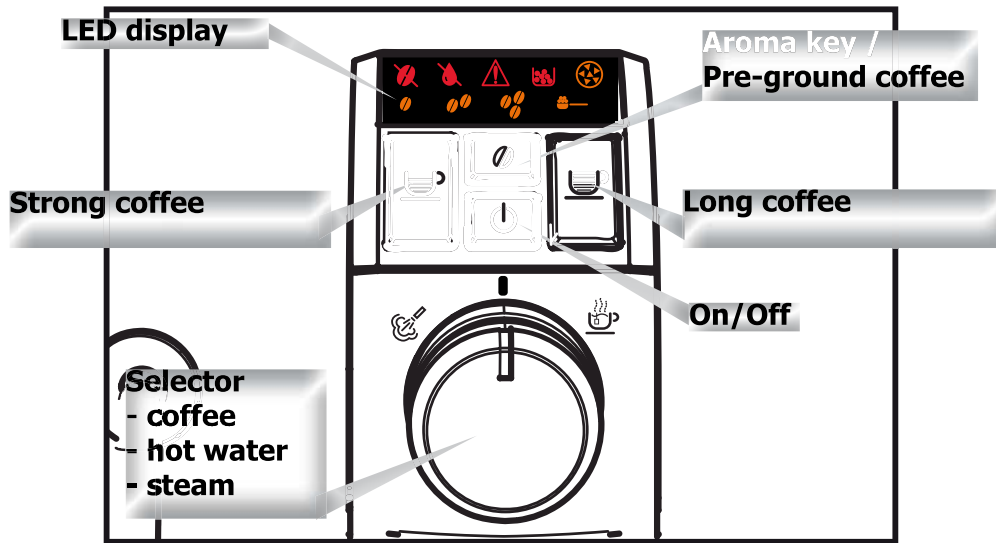

3.1.2 customer menu and Focus programming







Machine ready signals

Indications	Status	Causes	Solutions
	Fixed	Machine at correct temperature - for coffee bean dispensing - for hot water dispensing	Proceed with the dispensing process
	Fixed		
	Fixed	Machine at correct temperature - for ground coffee dispensing (pre-ground)	Proceed with the dispensing process
	Fixed		
	Slow blinking	Machine in phase for dispensing 1 cup of espresso	Dispense 1 espresso
	Rapid blinking	Machine in phase for dispensing 2 cups of espresso	Dispense 2 cups of espresso
	Slow blinking	Machine in phase for dispensing 1 cup of long coffee	Dispense 1 cup of long coffee
	Rapid blinking	Machine in phase for dispensing 2 cups of long coffee	Dispense 2 cups of long coffee
	Blinking	Machine in the phase of programming the quantity of coffee to be dispensed (Keep the espresso or long coffee button pressed)	Stop dispensing as desired
	Blinking		

Notice signals

Indications	Status	Causes	Solutions
	Blinking	Machine in alarm status - for coffee bean dispensing - for hot water dispensing	With for the dispensing process
	Cyclical	Machine in rinsing phase	Wait for the machine to end the operation
	Fixed	The appliance requires a descaling cycle	Carry out the descaling cycle
	Blinking	The machine needs water circuit priming	Prime the water circuit

Segnali di allarme

Indications	Status	Causes	Solutions
	Blinking	Machine in alarm status - Put the hot water/steam tap knob back in the correct position - The brew group is not inserted - Close the service door	
	Fixed	Empty the dregs drawer	
	Blinking	Insert dregs drawer	
	Fixed	No beans inside the coffee container	Re-start the cycle after filling the container
	Fixed	Fill water tank	

3.2. Operation, cleaning and maintenance

Operating the machine		
1	Fill water tank	
2	Fill the coffee bean container	
3	Switch on the appliance	
4	Fill the circuit	Place a container under the steam arm, turn the selector to the  symbol and wait for the appliance to return to coffee ready status.
5	Press the coffee key	Press once for one coffee; twice for two coffees

CLEANING AND TECHNICAL SERVICING		
A	Empty the dregs drawer	When indicated
B	Empty the drip tray	As necessary
C	Clean the water tank	Weekly
D	Clean the coffee bean container	As necessary
E	Clean the casing	As necessary
F	Clean the brewing unit	Every time the coffee bean container is filled or weekly
	Lubricate the brewing unit	Once a month or every 500 dispensing procedures
	Clean the unit housing	Weekly
H	Perform descaling	When indicated

Descaling cycle frequency			
Hardness	Water hardness	Without limescale filter	With limescale filter
1	Soft water (up to 7°dH)	Approx. every 3 months / 120 litres	Approx. every 6 months / 240 litres
2	Medium water (7° - 14°dH)	Approx. every 2 months / 90 litres	Approx. every 4 months / 180 litres
3	Hard water (15° - 21°dH)	Approx. every 6 weeks or 60 litres	Approx. every 3 months / 120 litres
4	Very hard water (over 21°dH)	Approx. every 4 weeks or 30 litres	Approx. every 6 weeks or 60 litres

CHAPTER 4

OPERATING LOGIC

4.1. Water circuit

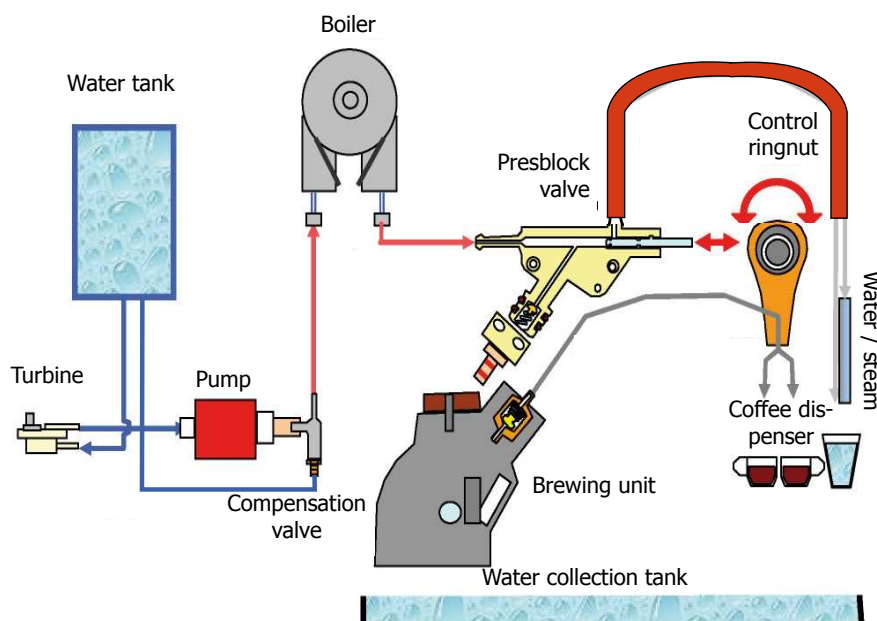
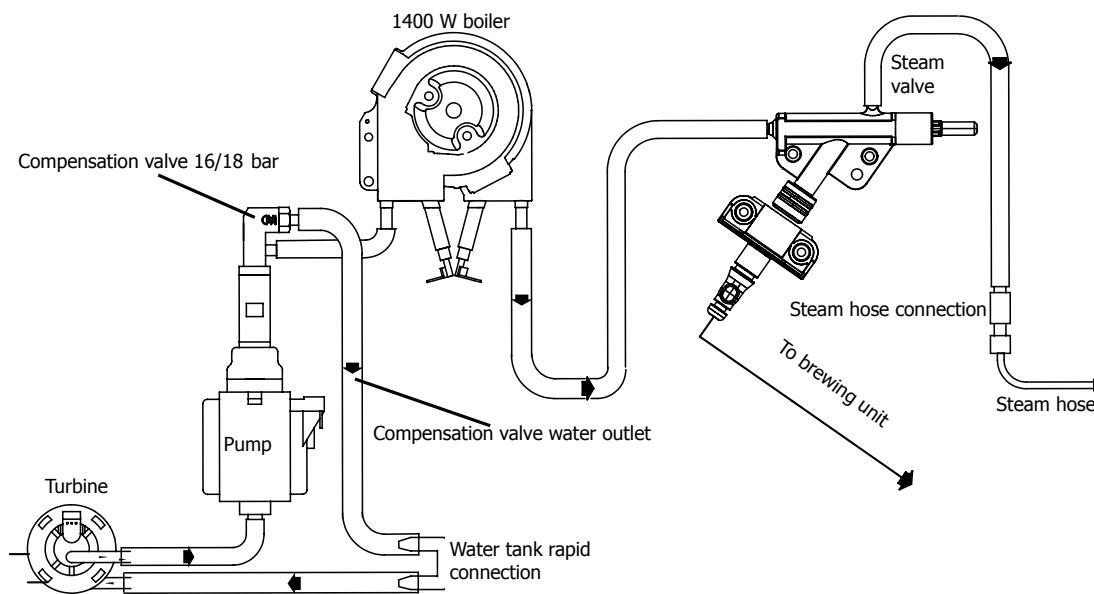

- Traditional water system
- Turbine – Amount of coffee dispensed into the cup
- Reciprocating piston type pump (13 - 15 bar)
- Compensation valve (opening pressure 16 - 18 bar)
- Boiler – 1400 W
- Presblok valve – select coffee – hot water - steam

4.2. Control ringnut and valve

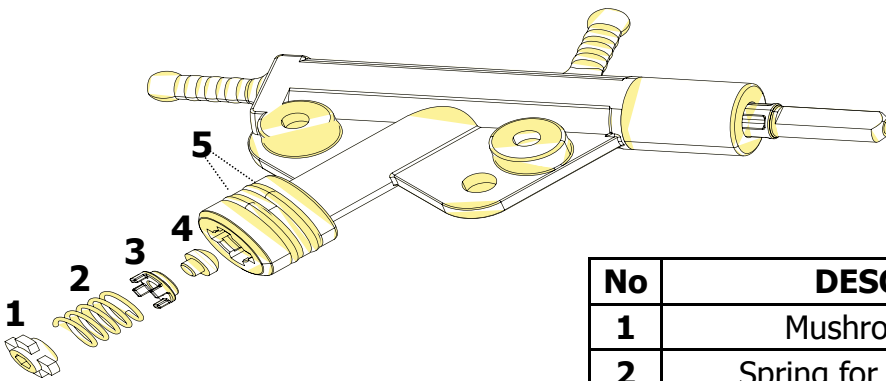

No	DESCRIPTION
1	Mushroom valve cap
2	Spring for mushroom valve
3	Mushroom valve support
4	Mushroom valve
5	Sealing OR

When dispensing coffee the mushroom valve opens at 4 bar +/- 0.5

Manual opening when dispensing water

Manual opening when dispensing steam

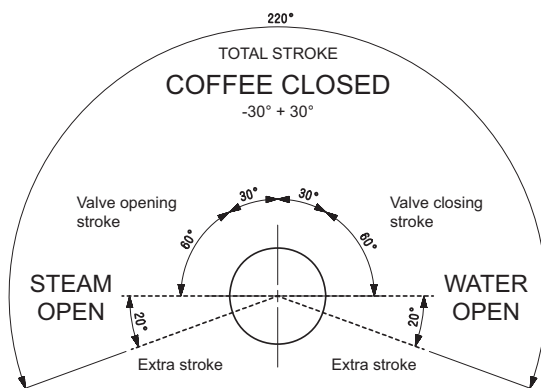
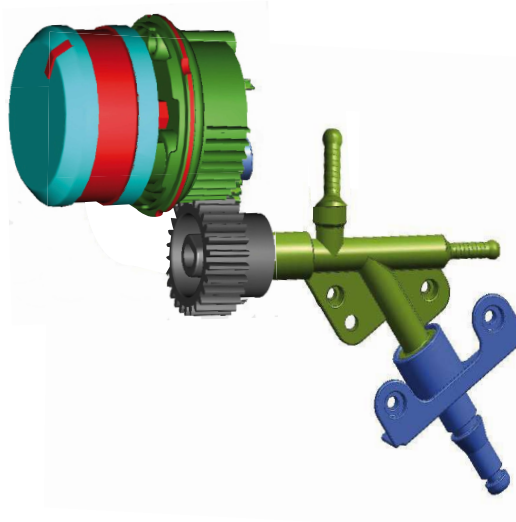

4.3. Coffee cycle operating diagram

Main switch ON	START		STOP
Time			
Coffee grinder			Pulses (Dosage)
Heating	approx. 45 secs.		
Pump			Pump activity (turbine pulses) depending on the product quantity selected *
Brewing unit gear motor			
Status	Heating	Ready	Coffee cycle

Notes: * Only with Pre-brewing



Single microswitch gear motor

Switching on

When the machine is switched on, the gear motor repositions itself as follows:

- It acts on microswitch 1 (see following. section)
- The gear motor changes its rotation direction and moves upwards again by approx. 1-2 mm
- The boiler begins to heat water for approx. 45 seconds. It absorbs all the available heating power in order to reach the optimal temperature. The temperature will then remain at a constant level.

Coffee cycle

1. The coffee grinder starts the grinding process (controlled by pulses generated by a sensor)
2. The gear motor (brewing unit) moves to the dispensing position
3. Preliminary dispensing phase (short pump activity, short pause)
4. Product dispensing (the pump operation period is defined by the amount of product dispensed)
5. The gear motor moves to its home position (the dregs are expelled automatically)

4.4. Single microswitch

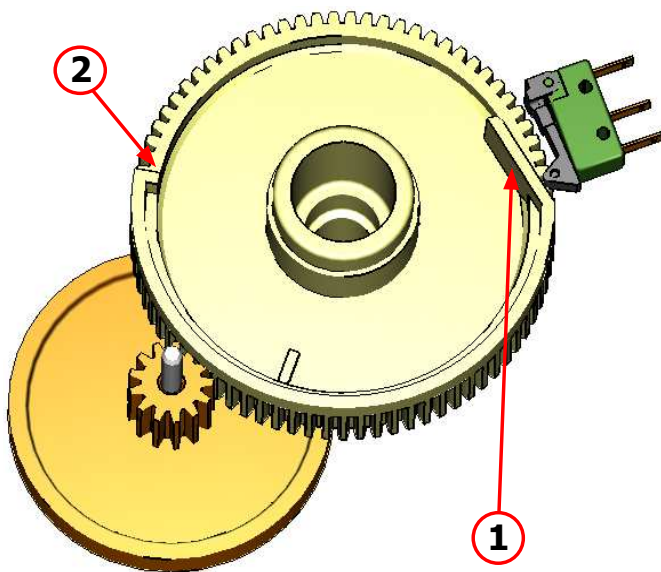

The gear motor is powered by a direct current motor that engages with the smaller double toothed wheel using a worm screw. The unit is mounted on the axle of the large gear wheel and when a coffee is requested, it moves from the home position to the dispensing position, and then back to the home position again.

- Home position: **1**
- Dispensing position: **2**

4.5. Temperature sensor (adjustment)

Temperature sensor

An NTC is used as a temperature sensor; in the event of overheating this reduces boiler element power consumption.

The electronic system detects the current boiler temperature from the drop in voltage and adjusts it accordingly.

Resistor values: see table

Temp. (°C)	R nom (kΩ)	ΔR (+/- %)
20	61,465	8,6
50	17,599	5,9
75	7,214	4,1
80	6,121	3,7
85	5,213	3,4
90	4,459	3,1
100	3,3	2,5
125	1,653	3,9
150	0,893	5,1

4.6. Coffee grinder function

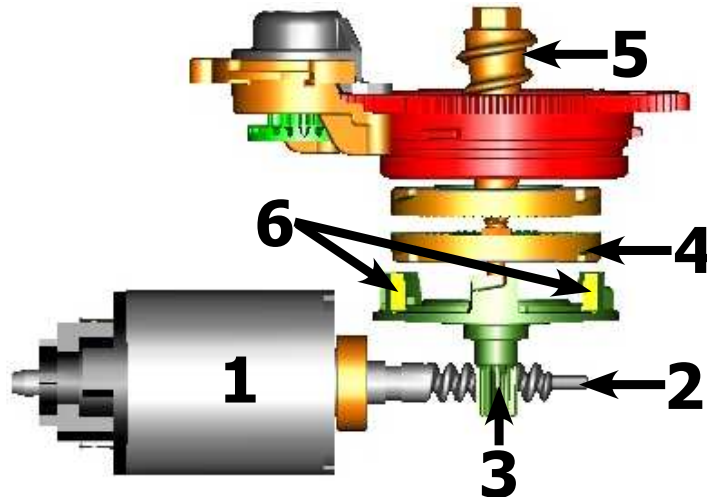

Ceramic coffee grinder

The coffee grinder is driven by a direct current motor (1) using a worm screw helicoidal wheel transmission (2).

The worm screw (2) drives a plastic gear wheel (3), which turns the lower grinder (4) and the increment pin (5)

There are two magnets (6) in the gear wheel; at every rotation these transmit two pulses to a Hall sensor, which in turn transmits them to the electronic system.

4.7. Low bean level detection, dose quantity adjustment, coffee grinder blocked

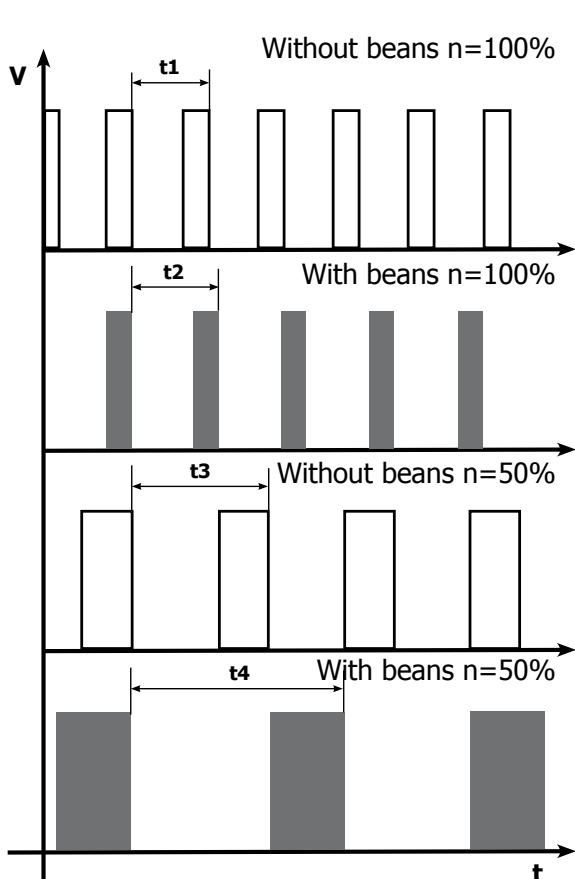

No coffee

A low coffee bean level is detected by the Hall sensor, after variations in the pulse frequency (with or without coffee). If there are no coffee beans (operation while empty), the number of rotations – and therefore the number of pulses – will be greater

t1 = No coffee indication

If, however, there are coffee beans, the number of rotations will be lower due to the force created by the grinding

t2 = no indication

t3 and t4 = this measurement is performed at the end of each grinding process

Dose quantity adjustment

The dose quantity is adjusted in accordance with the pulses detected (number of rotations proportional to the selected flavour – mild, medium or strong)

Coffee grinder blockage

If the coffee grinder becomes blocked for any reason, pulses will no longer be transmitted to the electronic system and the grinder will come to a stop

4.8 Dose self-learning (SAS)

The aim of this function is to automatically regulate the average dose of ground coffee (SELF-LEARNING); this occurs by means of an algorithm based on three pieces of information detected by the machine electronic board:

1. Number of coffee grinder pulses during the grinding cycle
2. Max. average value of the power consumed by the group motor during the coffee brewing cycle
3. Aroma selected by the user

The algorithm compares the maximum average value of the power consumed by the group motor with the value listed in the table for the selected aroma, in order to calculate the new grinding pulse value for the next coffee produced.

If the power consumption value is less than the minimum current value, the grinding pulses will be increased by 2.

If the power consumption value is greater than the maximum current value, the grinding pulses will be decreased by 4.

If the power consumption value falls within the "over-torque" interval, the product will be dispensed and the grinding pulses will be decreased by 10.

If the power consumption value falls within the "abort cycle" interval, the pad will be expelled and the grinding pulses will be decreased by 10.

If the "pre-ground" flavour is selected by the user, no modification will be made.

This guarantees that, regardless of the coffee type used, the grinding level setting and the wear on the grinders always remains constant.

Setting/Status		Power consumption in mA	Pulses corrected in the next grinding process	
			Exceeded by	Deficient by
A	Mild aroma	200 - 300 mA	- 4	+2
B	Medium Aroma	301 - 450 mA	- 4	+2
C	Strong Aroma	451 - 600 mA	- 4	+2
D	Over-limit	601 - 800 mA	- 4	
E	Over-torque	801 - 1,000 mA	- 10	
F	Abort cycle	> 1000 mA	- 10	

Important:

For perfect operation, machine adjustment should take place in the area of the fields highlighted in green (A, B, C). When the type or brand of coffee is changed, there may be variations in the size of the beans and their stickiness or roasting level. This leads to variations in power consumption (mA), with resulting excessive or insufficient doses (until the necessary adjustments have been made to compensate for this change).

Caution: In the case of excessive dosage, powder may be expelled into the dreg drawer. This is not a fault, but can occur during preliminary operation or after a service.

CHAPTER 5

SERVICE MODE

Rev.01 February 2010



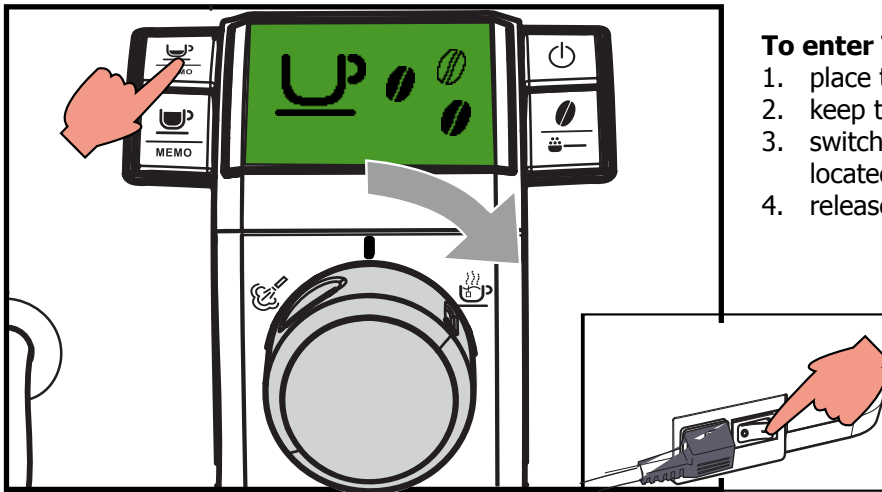

5.1. Digital test mode





To enter Test Mode





1. place the control knob in the water position
2. keep the espresso coffee key pressed
3. switch the appliance on from the 0/I button located at the rear of it
4. release the espresso coffee key

lev.	pos. knob	display	key	function	notes
L0 Software version		FIRMWARE 00.02.00		View software version	The software version must be the same as that stated on the MicroProcessor plate
PRESS THE ON/OFF KEY TO ACCESS THE NEXT LEVEL UP					
L1 Operational check – keys		KEYBOARD 1 2 3 4 N N N N		Initial condition with no keys pressed	
		KEYBOARD 1 2 3 4 Y N N N	 MEMO	no. 1 from "N to Y" and display from green change to red	If display does not change and remains as initial condition, replace interface card and/or flat cable JP21. If the colour of the display remains green, check JP4 wiring from interface card to display
		KEYBOARD 1 2 3 4 N Y N N	 MEMO	no. 2 from "N to Y" and display from green change to orange	
		KEYBOARD 1 2 3 4 N N Y N		no. 3 from "N to Y" and display remains green	If display does not change and remains as initial condition, replace interface card and/or flat cable JP21.
PRESS THE ON/OFF KEY TO ACCESS THE NEXT LEVEL UP					

lev.	pos. knob	display	key	function	notes
L2		INPUTS TAPCOFFE=Y TAPSTEAM=N DOOR=Y TAPWATER=N BU-P=Y TAP - ERR =N DREG=Y TANK-H2O=Y		Initial condition: Unit inserted, dregs drawer inserted, water tank full, side door closed, control knob in coffee position.	
		INPUTS TAPCOFFE=Y TAPSTEAM=N DOOR=Y TAPWATER=N BU-P=Y TAP - ERR =N DREG=Y TANK-H2O=N	Remove water tank	TANK-H2O display changes from "Y" to "N"	If TANK-H2O display does not change, check capacitive sensor and JP23 wiring
		INPUTS TAPCOFFE=Y TAPSTEAM=N DOOR=N TAPWATER=N BU-P=Y TAP - ERR =N DREG=N TANK-H2O=Y	Remove dregs drawer	DREGS display changes from "Y" to "N"	If display message does not change, check dregs drawer microswitch and JP16 wiring
		INPUTS TAPCOFFE=Y TAPSTEAM=N DOOR=N TAPWATER=N BU-P=Y TAP - ERR =N DREG=Y TANK-H2O=Y	Open side door	DOOR display changes from "Y" to "N"	If DOOR display does not change, check door microswitch and JP16
		INPUTS TAPCOFFE=Y TAPSTEAM=N DOOR=Y TAPWATER=N BU-P=N TAP - ERR =N DREG=Y TANK-H2O=Y	Remove coffee unit	BU-P display changes from "Y" to "N"	If BU-P display does not change, check unit presence microswitch and JP14
		INPUTS TAPCOFFE=N TAPSTEAM=N DOOR=Y TAPWATER=Y BU-P=Y TAP - ERR =N DREG=Y TANK-H2O=Y	Knob in water pos.	TAP-WATER display from "N to Y"	If TAPWATER, TAPCOFFE, TAPSTEAM, TAP - ERR display does not change, check knob card and/or connection wiring with interface card JP2. If TAP - ERR display continues to show "Y", check magnet polarity on knob support
		INPUTS TAPCOFFE=Y TAPSTEAM=N DOOR=Y TAPWATER=N BU-P=Y TAP - ERR =N DREG=Y TANK-H2O=Y	Knob in coffee pos.	TAP-COFFE display from "N to Y"	
		INPUTS TAPCOFFE=N TAPSTEAM=Y DOOR=Y TAPWATER=N BU-P=Y TAP - ERR =N DREG=Y TANK-H2O=Y	Knob in steam pos.	TAP-STEAM display from "N to Y"	
	Incorrect position	INPUTS TAPCOFFE=N TAPSTEAM=N DOOR=Y TAPWATER=N BU-P=Y TAP - ERR =Y DREG=Y TANK-H2O=Y	Knob in incorrect pos.	TAP - ERR display from "N to Y"	
	PRESS THE ON/OFF KEY TO ACCESS THE NEXT LEVEL UP				

Operational check microswitches and sensors

lev.	pos. knob	display	key	function	notes		
L3	Operational check brewing unit 	BU PAGE WORK=Y HOME=N CUR= 0			Initial status with no keys pressed		
		BU PAGE WORK=Y HOME=N CUR= 178		Bring the unit to the "WORK" position	CUR= --- indicates the gearmotor absorption; this value must be: WITHOUT BREWING UNIT INSERTED lower than 200mA WITH BREWING UNIT INSERTED lower than 300 mA		
		BU PAGE WORK=N HOME=N CUR= 497	 MEMO	ERROR: WORK display shows "N", display from green change to red. Check gearmotor gear microswitch (broken or inserted incorrectly) or motor (locked). Check JP16 wiring.			
		BU PAGE WORK=N HOME=N CUR= 203		ERROR: (WITHOUT UNIT inserted) If the gearmotor motor current absorption is higher than 200mA, display from green change to red. Check gearmotor unit and/or motor			
		BU PAGE WORK=N HOME=N CUR= 337		ERROR: (WITH UNIT inserted) If the gearmotor motor current absorption is higher than 300mA, display from green change to red. Check gearmotor unit and/or motor			
		BU PAGE WORK=N HOME=Y CUR= 193		Bring the unit to the "HOME" position	CUR= --- corresponds to the gearmotor absorption; this value must be: WITHOUT UNIT INSERTED lower than 200mA WITH UNIT INSERTED lower than 300 mA		
		BU PAGE WORK=N HOME=N CUR= 497	 MEMO	ERROR: HOME display shows "N", display from green change to red: check gearmotor gear microswitch (broken or inserted incorrectly), gearmotor motor (locked), wiring JP16			
		BU PAGE WORK=N HOME=N CUR= 203		ERROR: (WITHOUT UNIT inserted) Gearmotor motor current absorption higher than 200mA, display from green change to red: check gearmotor unit and/or motor			
		BU PAGE WORK=N HOME=N CUR= 337		ERROR: (WITH UNIT inserted) Gearmotor motor current absorption higher than 300mA, display from green to red: check gearmotor unit and/or motor			
		PRESS THE ON/OFF KEY TO ACCESS THE NEXT LEVEL UP					

lev.	pos. knob	display	key	function	notes
L4		PUMP IMP = 0 L/H = 0			Initial status with no keys pressed and valve in water position
		PUMP IMP = 112 L/H = 13			Water supplied by the steam hose: the number indicating flow meter pulses (IMP) must increase. L/H must be between 12 and 16
		PUMP IMP = 0 L/H = 0			ERROR: Display from green change to red and 0 pulses: check pump, turbine, turbine wiring and/or CPU/POWER card connection (JP5), pump wiring and/or CPU/POWER card connection (JP24)
PRESS THE ON/OFF KEY TO ACCESS THE NEXT LEVEL UP					
L4		HEATER GRINDER OFF 0 30 0 15 15			Initial status with no keys pressed
		HEATER GRINDER OFF 40 30 15 15 14			The number indicating COFFEE GRINDER MOTOR rotation increases up to 40. The two other numbers on the display are not important for the test
		HEATER GRINDER OFF 0 30 0 15 15			ERROR: The number is 0 with no coffee grinder motor rotation, display from green change to red: check grinder sensor and/or motor, sensor wiring and/or CPU/POWER card connection (JP2), grinder motor wiring and/or CPU/POWER card connection (JP8)
		HEATER GRINDER ON 40 49 15 14 14			Power absorption OK, the HEATER display changes from "OFF" to "ON" and the temperature increases
		HEATER GRINDER OFF 40 159 15 SHORT 14			ERROR: "SHORT" appears below HEATER, boiler temperature sensor disconnected, display from green change to red: check boiler sensor wiring and/or CPU/POWER card connection (JP13 may be disconnected)
		HEATER GRINDER OFF 40 71 15 OPEN 14			ERROR: "OPEN" appears below HEATER, boiler temperature sensor open, display from green change to red: check boiler sensor wiring and/or CPU/POWER card connection (JP13 may be disconnected)
					ERROR: Power absorption KO and temperature does not increase: check power supply wiring and/or CPU/POWER card connection (JP17-3)

5.1.2 Focus test mode

To enter Test Mode



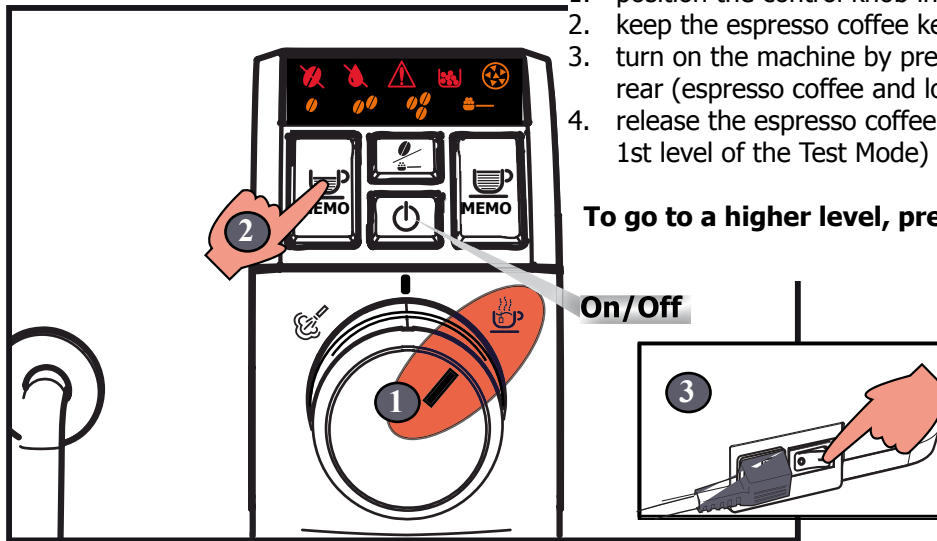















1. position the control knob in the hot water position
2. keep the espresso coffee key pressed
3. turn on the machine by pressing the O/I button on the rear (espresso coffee and long coffee blink alternatively)
4. release the espresso coffee button (you go directly to the 1st level of the Test Mode)

















To go to a higher level, press the On/Off button











lev.	pos. knob	symbol	button status	press	function
L1 Operational check - keys					Initial LED status at level 1 If the screen does not change from the initial status, replace the interface card and/or the JP21 flat cable.
PRESS THE ON/OFF KEY TO ACCESS THE NEXT LEVEL UP					

lev.	pos. knob	symbol	button	function
L2 Operational check - microswitches and sensors				Initial LED status at level 2
			Remove water tank	If the LED does not turn on, check the capacitive sensor and the JP22, JP23 wiring
			Open service hatch	If the LED does not turn on, check the hatch microswitch and the JP16 wiring
			Remove dregs drawer	If the LEDS do not turn on, check the microswitch and the JP16 wiring
			Remove the brew group	If the LED does not turn on, check the group microswitch and the JP14 wiring
				If the LEDS do not turn on, check the knob card and the JP21 wiring
				If the LED does not turn on, check the knob card and the JP21 wiring
PRESS THE ON/OFF KEY TO ACCESS THE NEXT LEVEL UP				

lev.	pos. knob	symbol	status	press	function
L3 Operational check - brewing unit		 			Initial LED status at level 3
		 			The brewing unit goes into the "Work" position and the button  turns on . The symbol  turns on if strain is excessive. Check operation of the gearmotor and microswitch of the gear (broken or inserted incorrectly). Check the JP16 wiring
		 		 MEMO iturns off as soon as it is pressed	The brewing unit goes into the "Home" position and the button  turns on . The symbol  turns on if strain is excessive. Check operation of the gearmotor and microswitch of the gear (broken or inserted incorrectly). Check the JP16 wiring
PRESS THE ON/OFF KEY TO ACCESS THE NEXT LEVEL UP					

lev.	pos. knob	symbol	status	press	function
L4 Operational check - pump		 			Initial LED status at level 4
		 			The water is dispensed from the steam pipe and blinks  The symbol  turns on if water is not dispensed. Verify checks at the pump, pump wiring and/or connection on the CPU/Power card(JP24), turbine, turbine wiring and/or connection on the CPU/Power card(JP5).
		 			To check correct passage of water from the coffee duct, return to level 2 (brewing unit functional check), put the unit in the "Work" position, and the knob will blink in the coffee position 
PRESS THE ON/OFF KEY TO ACCESS THE NEXT LEVEL UP					

boiler

lev.	pos. knob	symbol	status	press	function
L5 Operational check - coffee grinder and					If the symbol  appears, the boiler sensor is interrupted. Check the boiler sensor wiring and/or the connection on the CPU/Power card (JP13)
		 			If the the current absorption is KO, check the power wiring and/or the connection on the CPU/Power card (JP17-3)
		 			The coffee grinder is enabled by pressing the "AROMA" button, and the button  starts to blink .If this does not occur and the symbol  turns on, check the sensor and/or the coffee grinder motor, the wiring of the sensor and/or the connection on the CPU/Power card (JP2), the wiring of the coffee grinder motor and/or the connection on the CPU/Power card (JP8)

5.2. Error codes

ERROR CODES	DESCRIPTION
01	The grinder is blocked (burrs jammed or sensor not reading properly)
03	The brewing unit is blocked in work position (microswitch not released in up position after 3", torque error trying to move down, descent time out exceeded)
04	The brewing unit is blocked in home position (microswitch not released in down position after 3", torque error trying to move up, ascent time out exceeded)
05	Water circuit / flow meter problems (water circuit blocked or no flow meter signal)
10	Boiler temperature sensor short circuited
11	Boiler temperature sensor open circuit
14	The boiler temperature has exceeded the maximum allowed value (165°C)
15	The boiler temperature has not increased by x°C in y sec (boiler power supply disconnected, incorrect boiler fitted must be a 1300W boiler, partial power supply to boiler, cut out thermostat tripped)
19	Mains voltage trouble

CHAPTER 6

SERVICING AND MAINTENANCE

6.1. Repair schedule

	Action
1	Visual inspection (transport damage)
2	Machine data check (rating plate)
3	Operational check / problem analysis
4	Opening machine
5	Visual inspection
6	Operational tests
7	Repairing the faults encountered
8	Checking any modifications (view info, new sw, etc.)
9	Service activities in accordance with the operating schedule
10	Internal cleaning
11	Operational test while the appliance is open
12	Assembly
13	Final inspection test
14	Draining the circuit (in winter)
15	External cleaning
16	Lubricating the brewing unit with suitable grease
17	Insulation test HG 701 (dielectric)
18	Documentation

6.2. Service schedule

S	Replacement
ES	Visual inspection
D	Descaling

P	Cleaning
TR	Noise test
R	Adjustment

Component	Action	Support/tool
Water filter	P/S	
Water tank lip seal	S	
Boiler pin O-ring	S	
Brewing unit	ES/P	Grease solvent / Grease
Hoses, attachments and Oetiker clamps	ES	
Pump	ES/TR	
Gear motor	ES/TR	
Coffee grinder	P/R	Vacuum cleaner / brush
Water circuit	D	Saeco descaler
Hot water/steam valve	ES/S	

6.3. Final test

Test	Procedure	Support/tool	Standard	Tolerance
Espresso	2-3 Espressos for adjustment purposes	Measuring beaker	Same amount	15%
Coffee	2-3 Coffees for adjustment purposes	Measuring beaker	Same amount	15%
Noise			Standard	
Amount of "crema"	Blow into the cup until the "crema" separates		The "crema" should come together again to form a complete layer	
"Crema" colour			Hazel brown	
Temperature	Reading taken while dispensing	Thermometer	84 °C	± 4 °C
Grinding level	Check the grain size of the ground coffee			
Hot water	Dispense water			
Steam	Dispense steam			
Grounds drawer missing indication	Remove the grounds drawer		Grounds drawer missing indication	
Low bean level indication	Start brewing a coffee while the coffee bean container is empty		Low bean level indication	

CHAPTER 7

DISASSEMBLY

Rev.01 February 2010

7.1. Outer elements disassembly

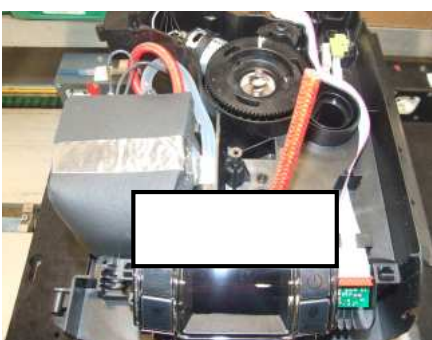

Disassembling the Top cover

1) Remove the grounds drawer, water tank, coffee container lid, drip tray, brewing unit, steam wand covering cap, pannarello and control knob cover

2) Unscrew the screws shown and remove the finger protection device and coffee hopper

3) Unscrew the screw shown and extract the control knob

4/5) Unscrew the screw shown and extract the coffee dispenser fixed support by lifting it upwards

6) Unscrew the screws shown located inside the compartments containing the water tank and grounds drawer

7) Lift the lid and disconnect the earth wire shown

When refitting the machine cover, take great care not to scratch the keypad cover. Put a sheet of paper on the keypad cover (see photo) before refitting the machine cover and slide it out at the end of assembly

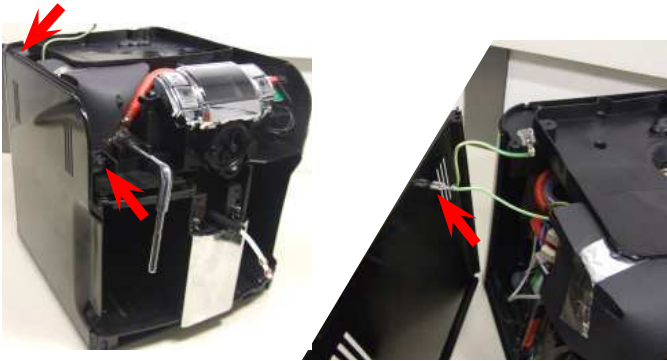

Disassembling the side cover

Unscrew the screws shown and disconnect the earth wire



Disassembling the side door

Lift the door and unhook it from the support hinge



Disassembling the rear cover

Unscrew the screws shown

7.2. Coffee dispenser disassembly

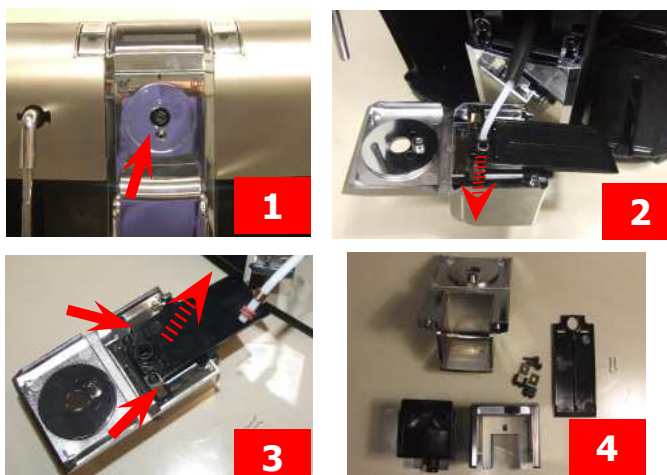

1) Unscrew the screw shown

2) Slide out the fork clip

3) Unscrew the screws shown and remove the support

4) Coffee dispenser assembly parts

7.3.1 Disassembling Keypad card and Digital Control Knob



1) Unscrew the screw shown, remove the lid, glass, frame, keypad and seal

2) Release the display support

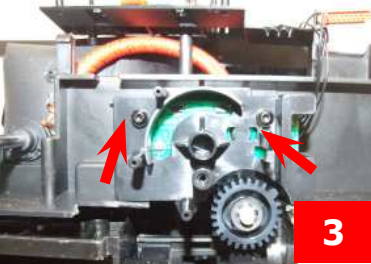

3) Unscrew the screws shown and remove the spring washer

4) Parts



5) Release the control knob circuit board

6) Release the display

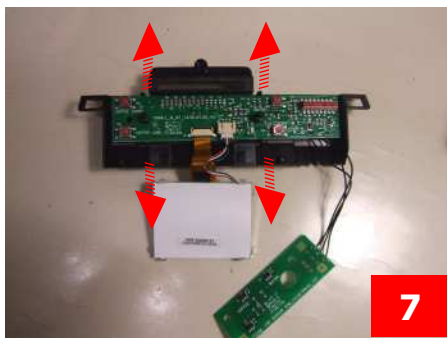

7) Release the keypad circuit board and disconnect the display

7.3.2 Disassembling Keypad card and Focus Control Knob

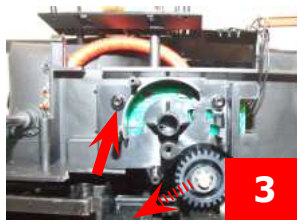
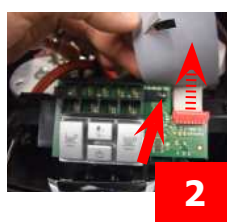

1) Remove the display frame by lifting it and slip off the upper cover

2) Slip off the flat cable and loosen the highlighted screw

3) Loosen the highlighted screws and remove the elastic washer



4) Display and interface cards assembly

7.4. Power/CPU disassembly

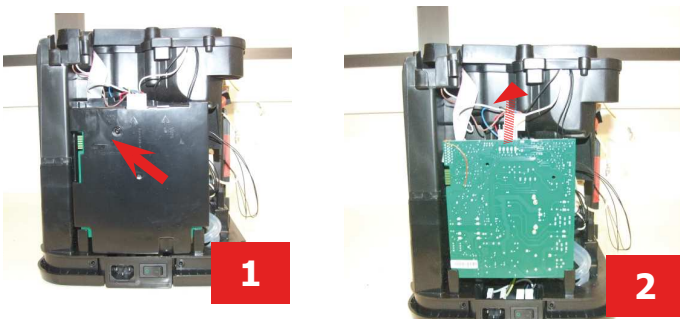

1) Loosen the screw shown and remove the card protection

2) Slide out the card, removing all connections

7.5. Gearmotor disassembly

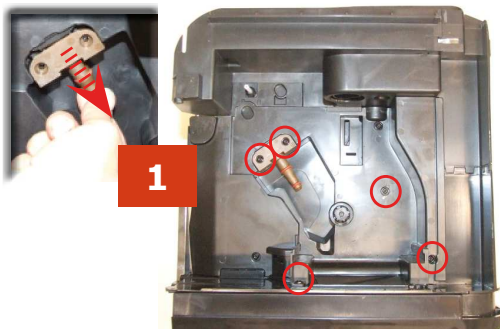

1) Loosen the screws holding the boiler pin in place, remove it and loosen the other screws shown

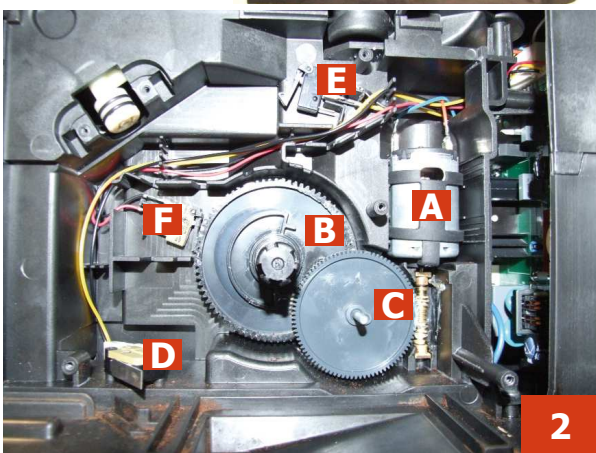

2) The following are located inside the compartment protected by the casing:

- Brew drive (A) with gears (B) and (C) for transmission and timing of the dispensing head.
- Grounds drawer present microswitch (D).
- Brewing unit present microswitch (E).
- Microswitch (F) detecting brewing unit home and work positions.
- Remove the gear (C) that meshes with the motor transmission shaft
- Remove the large gear (B)
- Remove the motor (A), complete with transmission shaft

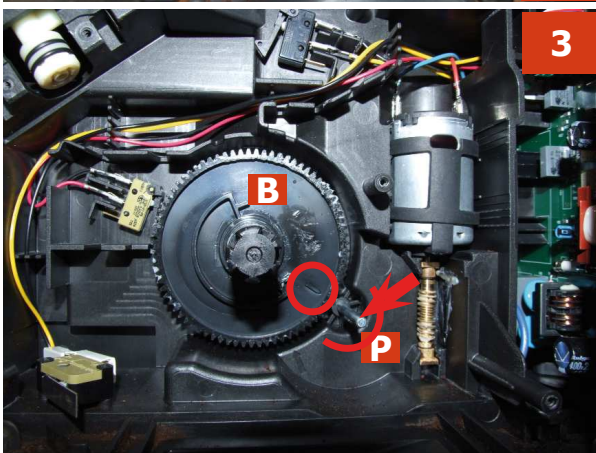

3) Replace the gear (B), making sure that the imprint of the arrow is aligned with the opening containing the pin (P)

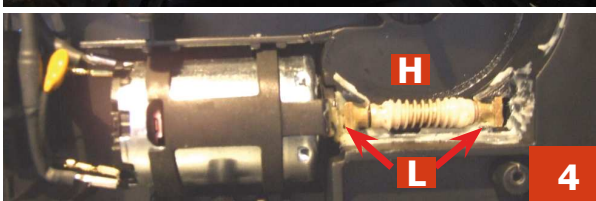

4) When replacing the motor and the transmission shaft, make sure the bearings (L) are in the right position.
Grease the shaft thoroughly and evenly

7.6. Boiler disassembly

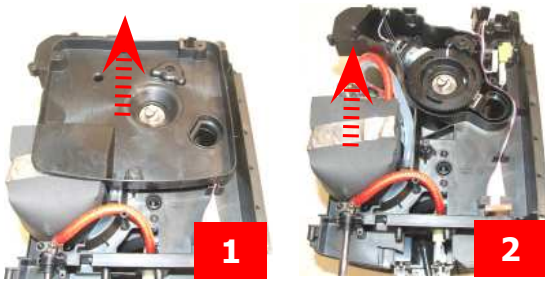

- 1) Remove the coffee grinder noise reduction cover
- 2) Remove the boiler insulation



- 3) Unscrew the screws shown



- 4) Loosen the screw and remove the plastic support.
Disconnect the hoses and the connections

7.7. Valve disassembly

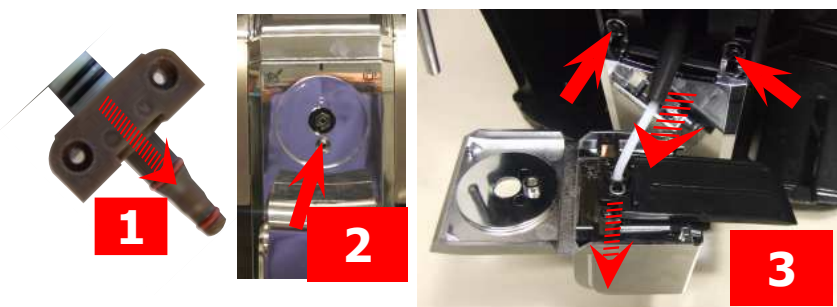

- 1) Remove the boiler pin
- 2) Remove the control knob cover and unscrew the screw as indicated

- 3) Lift and remove the dispenser assembly, slide out the fork clip shown and unscrew the screws holding the front piece

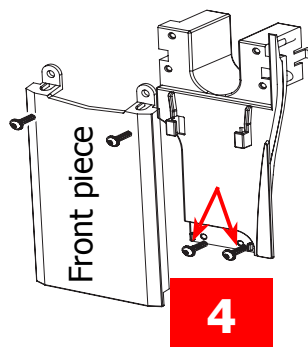

- 4) Unscrew the screws shown to remove the front piece support

- 5) Remove the spring washer and the control knob gear (steam/water)

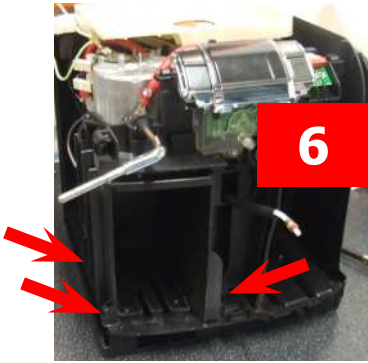

6) Remove the screws shown to remove the insert on the base of the casing

7) Remove the screws shown and disconnect the valve from the water connections

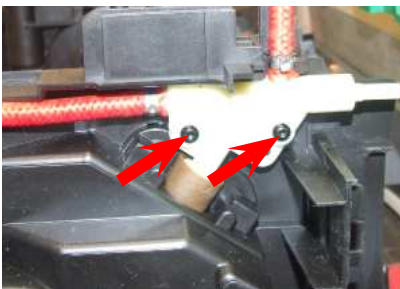

7) Remove the screws shown and disconnect the valve from the mesh hoses

7.8. Pump and turbine disassembly

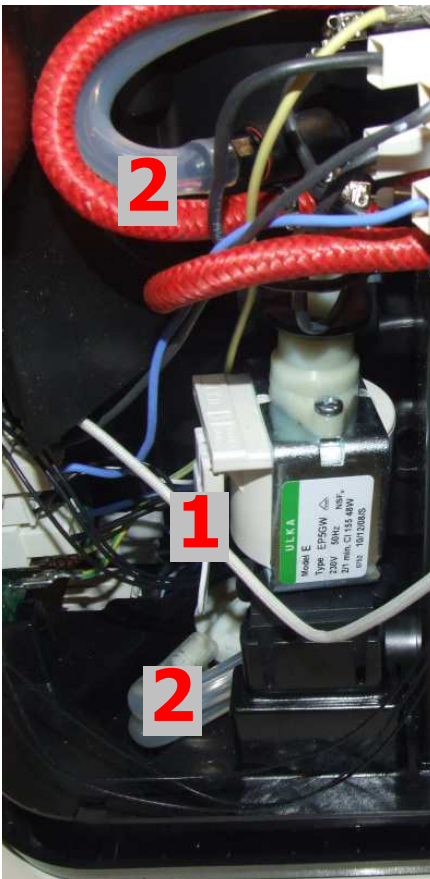

PUMP

Remove the connection **1**, disconnect the silicone hoses **2**
Unscrew the safety valve and remove the pump from the two supports

TURBINE

Remove the connection and disconnect the silicone hoses

7.9. OETIKER clamps assembly and disassembly

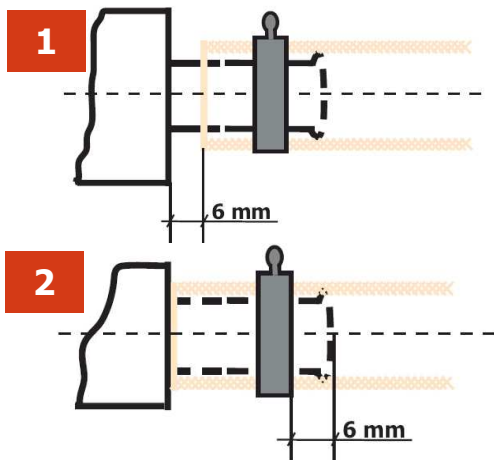

1) Boiler connection

2) Other connections



Replacing the hoses

1) Use a suitable pair of pliers to remove the clamp (as illustrated)



2) Tighten the clamp as illustrated

7.10. Coffee grinder disassembly



1) To remove the coffee grinder, simply slide it out and remove its connections

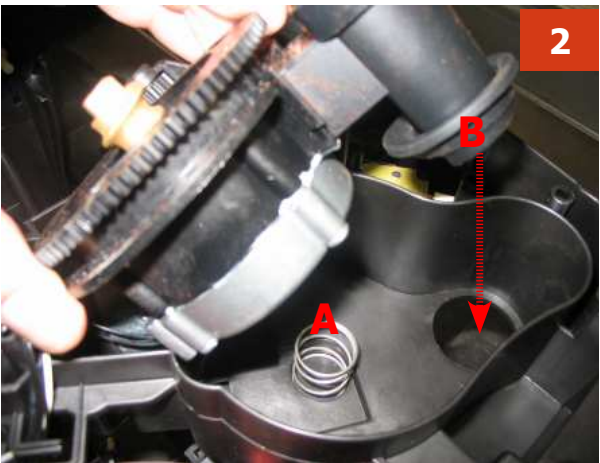

2) When replacing it, make sure the spring (A) and the coffee pipe (B) are positioned correctly

7.11. Grinder adjustment/assembly and disassembly



1

1) To remove the upper grinder support, using a hex key push down and turn clockwise to release the grinder support from the bayonet coupling



2

2) To remove the grinder blade from the upper support, turn it anti-clockwise until it detaches from the bayonet coupling



3

3) To remove the lower grinder blade, keep the increment pin (A) locked in position and turn the grinder blade anti-clockwise, until it detaches from the bayonet coupling

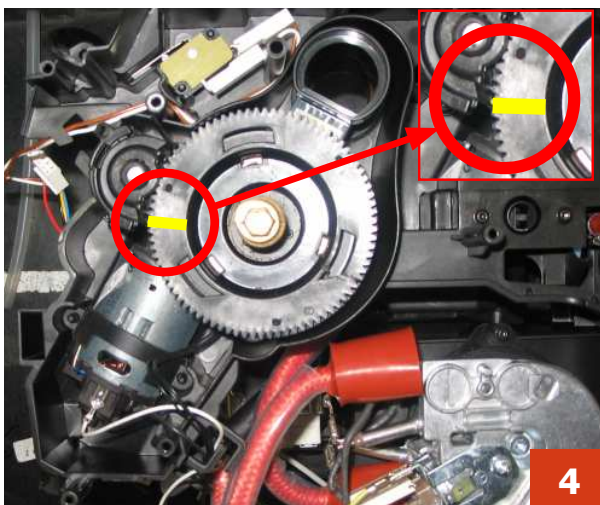

4

4) When refitting the upper grinder support, make sure you reposition it so that the mark is as illustrated in the photo

CHAPTER 8

NOTES

CHAPTER 9

WATER CIRCUIT DIAGRAM

9.1. Water circuit diagram

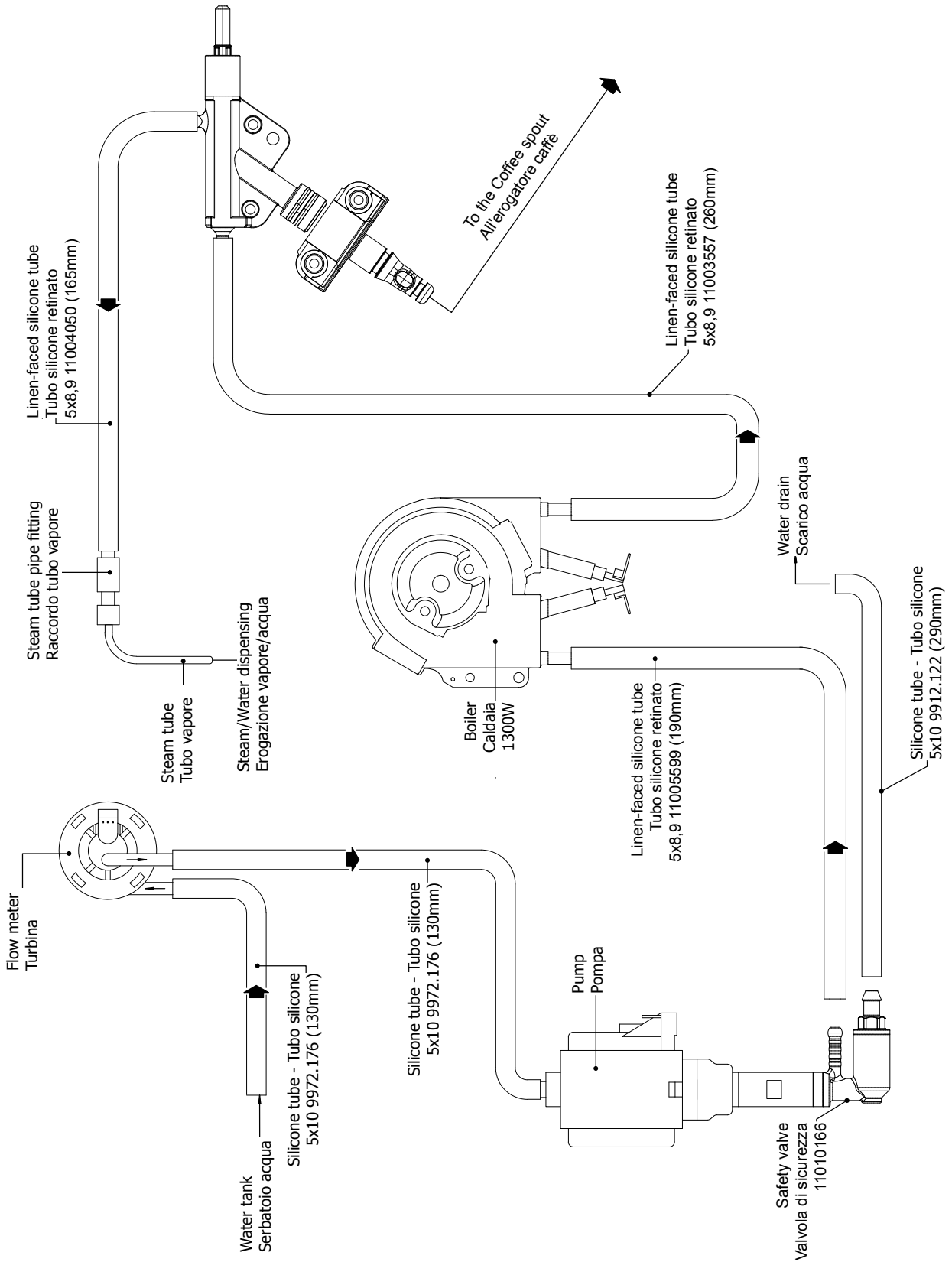

CHAPTER 10

ELECTRICAL DIAGRAM

10.1 Wiring diagram Digital

