

Service Service Service



Philips 4000 and 3000

Service Manual

Rev. 02 August 2015

Table of contents	Page	Table of contents	Page
1. Introduction		4. Operating logic	
1.1. Documentation required	1	4.1. Water circuit Philips 4000-3000	1
1.2. Tools and equipment required	1	4.2. Milk carafe	2
1.3. Material	1	4.3. Single microswitch	3
1.4. Safety warnings	1	4.4. Coffee grinder Philips 4000	4
1.5. Service Policy	3	4.4.1. Autodose system description	4
1.6.1. External machine parts Philips 4000	4	4.4.2. Coffee lack detection an coffee grinder blocked	5
1.6.2. External machine parts Philips 3000	5	4.5. Coffee cycle	6
1.6.3. Internal machine parts	6	4.5.1. Coffee grinder Philips 3000	7
		4.5.2. Low bean level detection, dose quantity adjustment, coffee grinder blocked	7
2. Technical specifications		4.5.3. Dose self-learning (SAS)	8
2.1. Technical specifications	1	4.6. Water level detection (water tank)	9
2.2.1. Specification for the measurement of the coffee products temperature	2	4.12. Descaling request	9
2.2.2. Specification for the measurement of the milk products temperature	3	4.13. Water filter	10
2.3. Machine parameters and performance	5	5. Troubleshooting	
3. User instructions		5.1. Test mode Philips 4000	1
3.1. Customer menu in the Philips 4000 OTC	1	5.1.1. SteamOut	8
3.2. Customer menu in the Philips 4000 AMF	3	5.2. Test mode Philips 3000	10
3.3. Customer menu in the Philips 4000 CMF	5	5.2.1. SteamOut	17
3.4. Customer menu in the Philips 3000 AMF	7	5.3. Error Codes	18
3.5. Customer menu in the Philips 3000 CMF	9		
3.6. Operation, cleaning and maintenance	13		

All parts of this document are the property of Philips.

All rights reserved. This document and all the information herein is provided without liability deriving from any errors or omissions. Furthermore, no part may be reproduced, used or collected, except where express authorisation has been provided in writing or through a contractual agreement.

Table of contents		Page
6.	Standard checks	
6.1.	Repair Flow	1
7.	Disassembly	
7.1.	Outer Shell	1
7.2.	Coffee grinder	2
7.3.	Grinder blades	3
7.4.	Coffee grinder adjustment	4
7.5.	Carafe connection and hot/Steam water dispenser	4
7.6.	Central plate	5
7.7.	Pin boiler	5
7.8.	Gear motor	6
7.9.	Pump	7
7.10.	Flow-meter	7
7.11.	Boiler	7
7.12.	CPU board	8
7.13.	Programming access for SSC (Saeco Service Center)	8
7.14.	KYB interface and display	8
7.15.	Fitting and removing Oetiker clamps	9
8.	Notes	
9.	Water circuit diagram	
10	Electrical diagram	

MODIFICATIONS TO SERVICE MANUAL				
From Rev.	To Rev.	Chapter	Inserted	Modified
Rev.01	Rev02	01		Par. 1.4. Safety warnings
		02		Par. 2.2.1 Specification for the measurement of the coffee products temperature. Par. 2.2.2 Specification for the measurement of the Milk products temperature.
		05	5.1. Test Mode Philips 4000 description values Heater Grinder	
		06		Par. 6.1 Repair Flow

CHAPTER 1

INTRODUCTION

1.1 Documentation required

The following documentation is needed for repair procedures:

- Instruction booklet for specific model
- Technical documentation for specific model (diagrams, exploded view, symptom cure and service manual)

1.2 Tools and equipment required

As well as the standard equipment, the following is required:

Qty.	Description	Notes
1	Screwdriver	
1	Pliers for Oetiker clamps	
1	CC -A - Vdc tester	
1	Digital thermometer	Scale limit > 150°C
1	SSC (Saeco Service Center)	Programmer (for programming and diagnostics mode)

1.3 Material

Description	Notes
Thermal paste	Heating element > 200°C
Descaler	Saeco descaler
Grease solvent	Personal choice
Silicone grease	Safe to use with food

1.4 Safety warnings

We recommend you consult the technical manual of the machine before performing any maintenance work.

Observe all applicable standards relating to the repair of electrical appliances.

Always disconnect the power plug from the mains before beginning repair work.

Always disconnect the power plug from the mains before beginning repair work.



Simply turning off the main machine power switch is not an adequate safety precaution. This domestic appliance is rated as insulation class I. On completion of the repair work, insulation and dielectric rigidity tests must be performed.



Disassembling the machine, the operator must pay attention to hot and under Pressure parts: boiler, pin-boiler, valves, dispensing, steam tube, brew unit, connections and pipes to avoid burns. Please refer to specific hydraulic circuit (Image1) to know the parts in detail.



The machine hydraulic circuit can reach maximum pressure of 16/18 bar. To operate in safety condition is recommended to perform the Steam Out procedure in order to remove the pressure and hot water inside the hydraulic circuit.

When the machine arrives at the Service Center in descaling mode interrupted, or making Descaling, be very careful not to come into contact with the Descaler. After the product has been repaired, it should function properly and has to meet the safety requirements and legal regulations as officially laid down at this moment

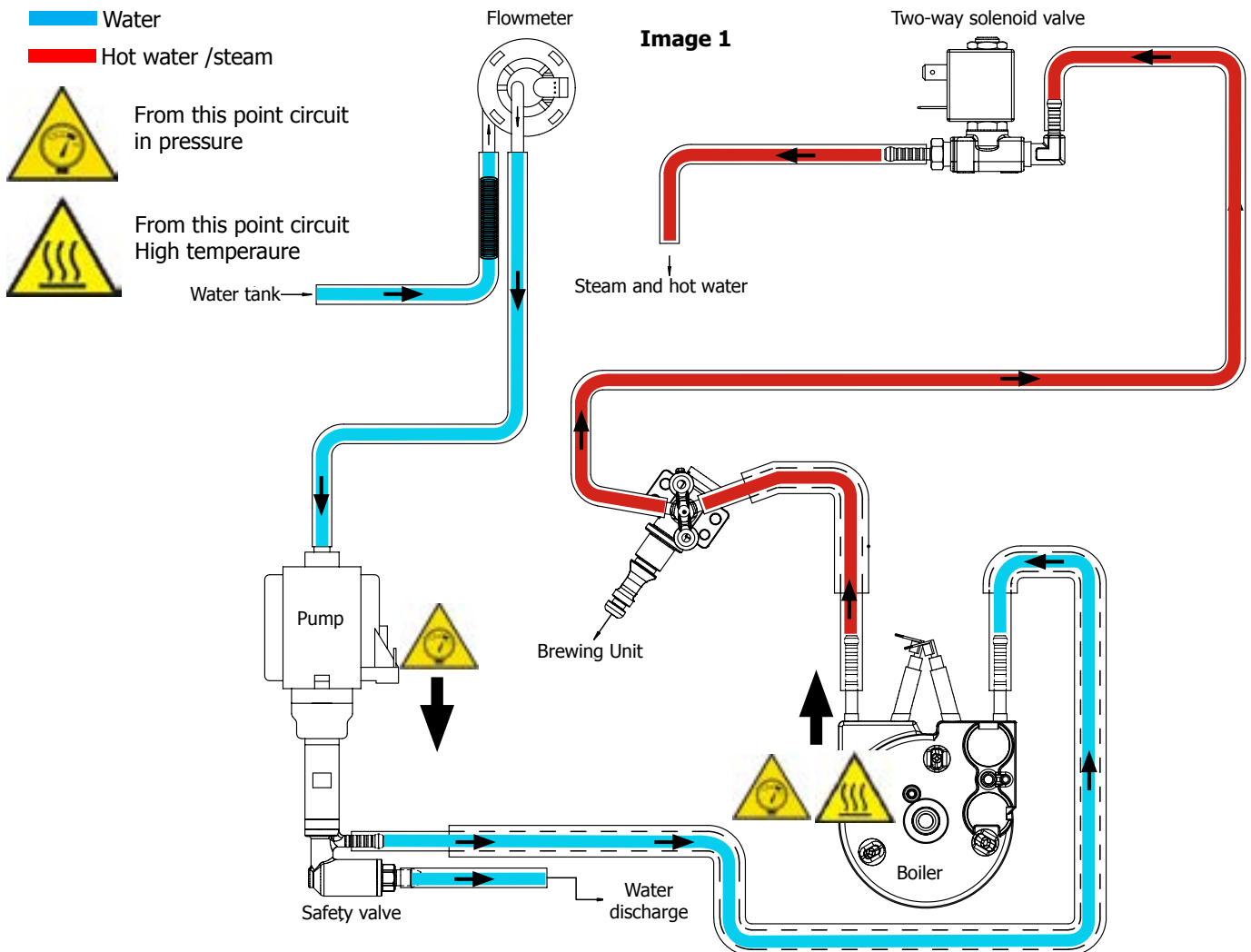

1.5 Service POLICY grid as used for coffee machine

For IN WARRANTY repairs is mandatory to use the single components (not the assembly) available in the exploded views of the coffee machines or of the specific components. If you find the information "SEE THE EXPLODED VIEW E....." in the assembly description field, it means that the single components of the assembly are available in the other pages of the exploded view. It's possible to use the assembly only if there is a specific Symptom Cure that include this possibility or when the single components are not available for the order.

List of principal assembly present in all our coffee machines

Components	Assembly use	Single components available
COFFEE GRINDER	<u>Only for OOW repairs</u>	YES , to consult the specific exploded-view of the machine or of the Coffee Grinder on website
BREWING UNIT	<u>Only for OOW repairs</u>	YES , to consult the specific exploded-view of the machine or of the Brewing unit on website
BOILER	<u>Only for OOW repairs</u>	YES , to consult the specific exploded-view of the machine on website
GEAR MOTOR	<u>Only for OOW repairs</u>	YES , to consult the specific exploded-view of the machine on website
FILTER HOLDER	<u>Only for OOW repairs</u>	YES , to consult the specific exploded-view of the machine on website
MILK CARAFE	<u>Only for OOW repairs</u>	YES , to consult the specific exploded-view of the machine on website
THERMAL CARAFE	<u>Only for OOW repairs</u>	YES , to consult the specific exploded-view of the Thermal Carafe on website
MILK ISLAND	<u>Only for OOW repairs</u>	YES , to consult the specific exploded-view of the Milk Island on website

1.6.1. External machine parts Philip 4000

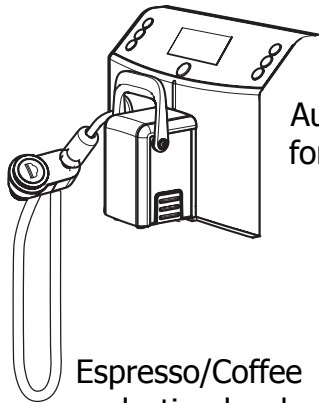

Automatic Milk Frother (also for steam dispensing) (AMF)

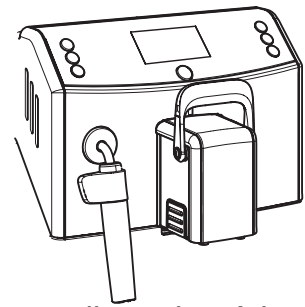

Classic Milk Frother (also for water/steam dispensing) (CMF)

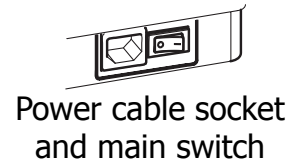
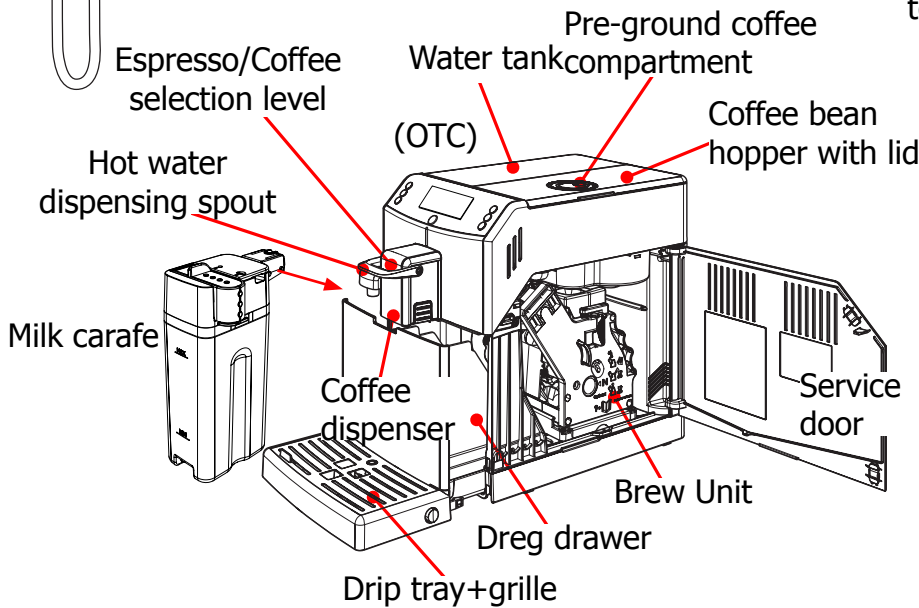

Power cable socket and main switch

4000 OTC

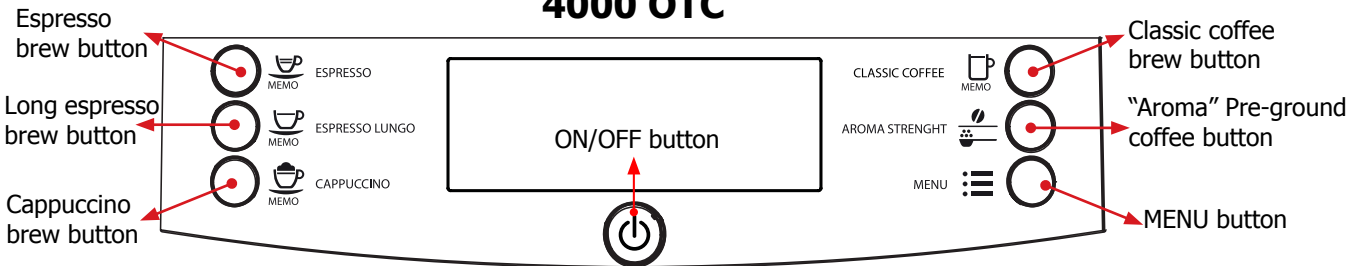

4000 AMF

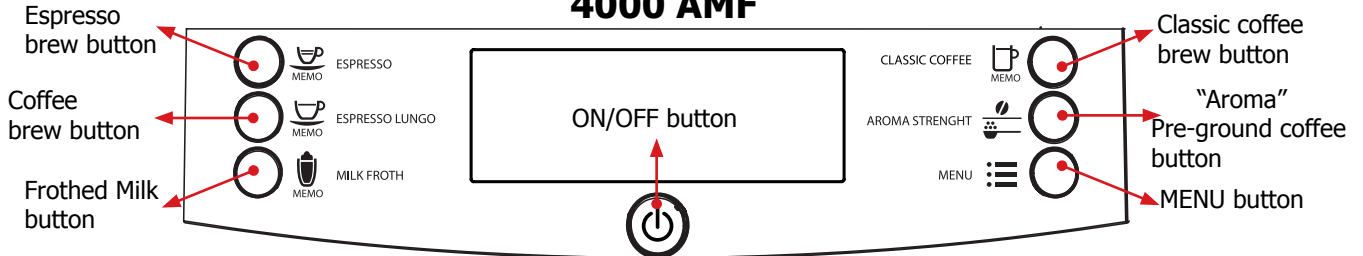

4000 CMF

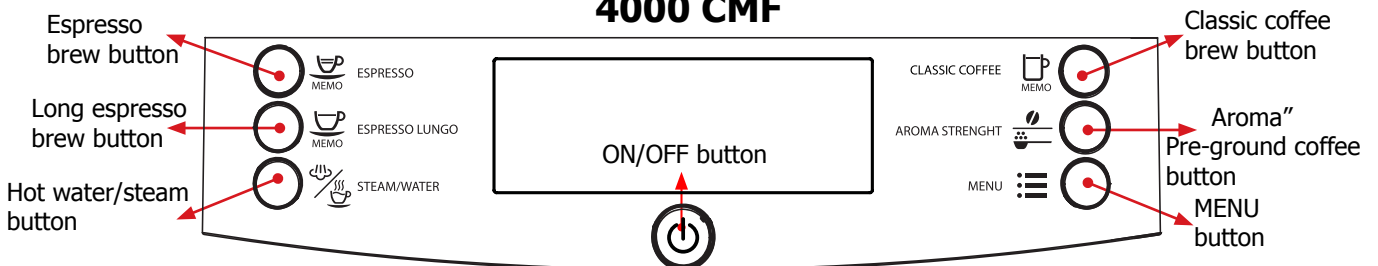

1.6.2. External machine parts Philip 3000

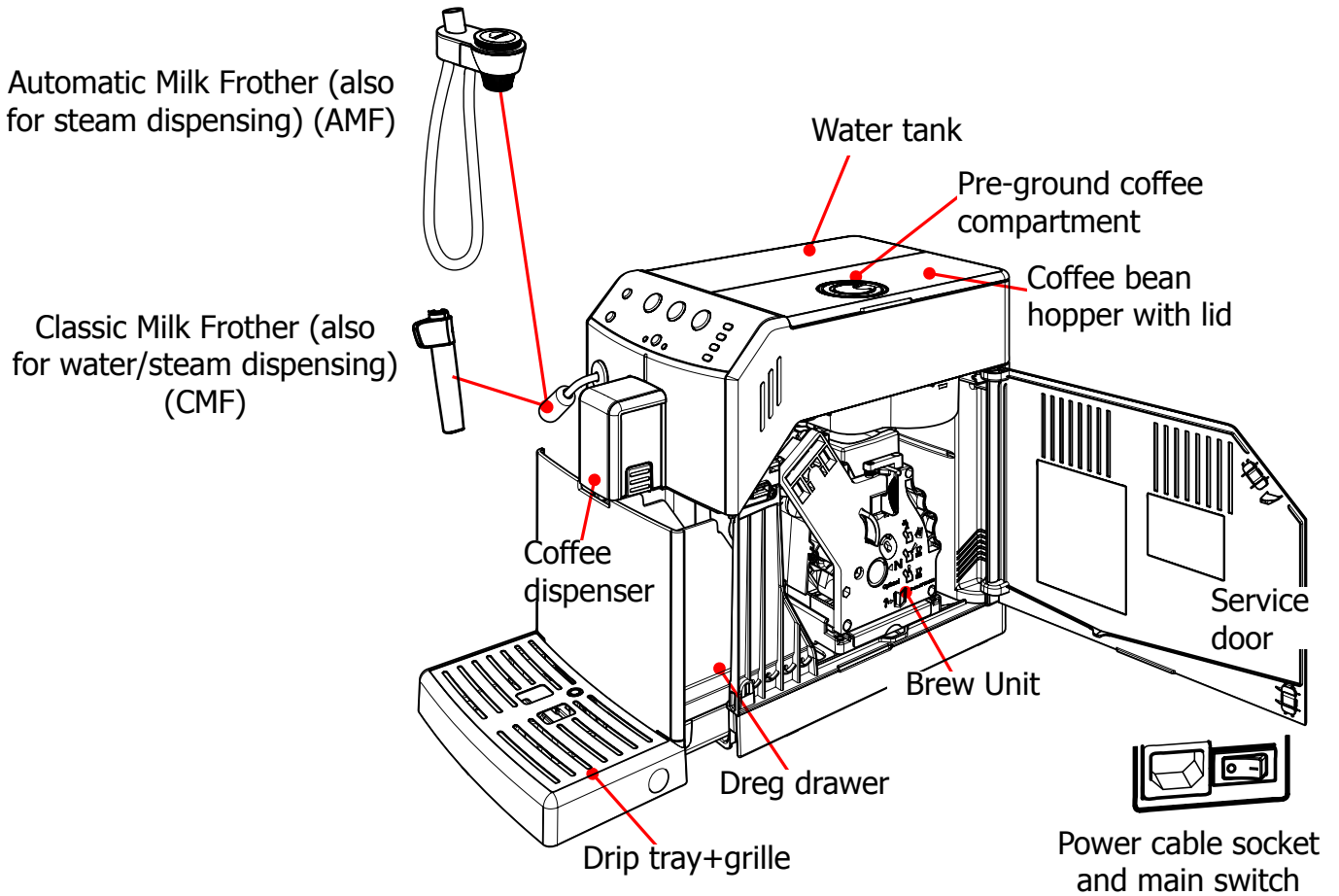

3000 AMF

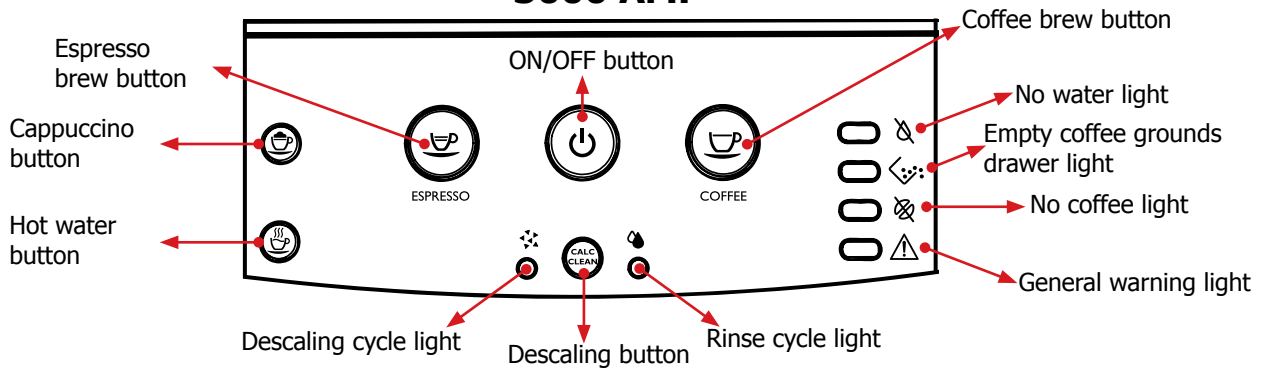

3000 CMF

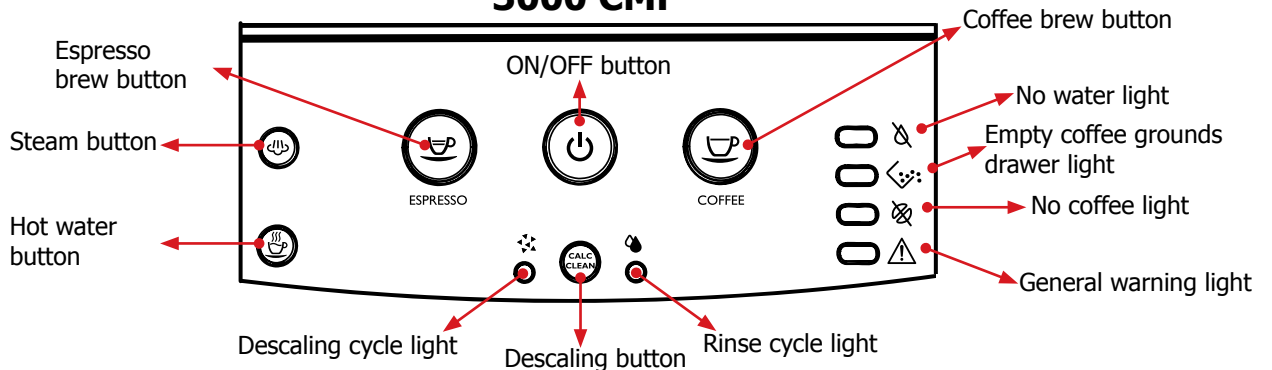

1.6.3 Internal machine parts

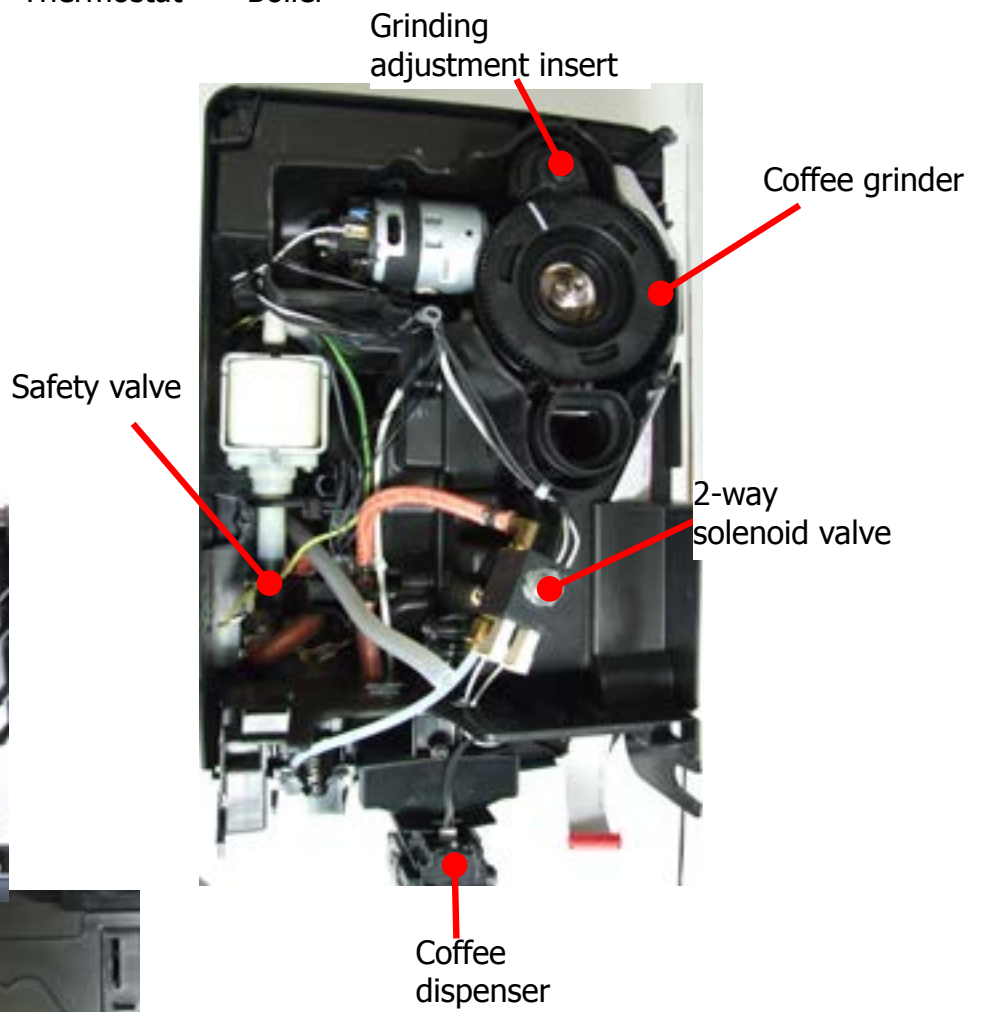
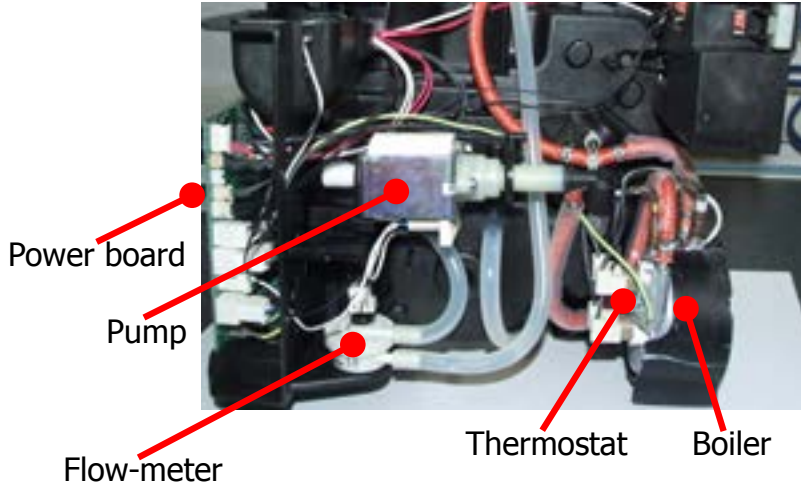

CHAPTER 2

TECHNICAL SPECIFICATIONS

2.1. Technical specifications

Power supply and output:	240 V~ 50 Hz 1850 W - 230 V~ 50/60 Hz 1850 W 120 V~ 60 Hz 1500 W
Temperature monitoring:	(NTC) variable resistor sensor - transmits the value to the electronic card
Safety system:	2 thermostats at 190°C one shot
Coffee heat exchanger output: Stainless steel	(230 V~) 1900 W - (120 V~) 1300 W - (100 V~) 1100 W for coffee, hot water and steam dispensing
Gear motor:	2 rotation directions; power supply 24VC
Pump:	Ulka Type EP5/S GW approx. 13-15 bar with reciprocating piston and thermal switch 100°C 48 W, 230V, 50 Hz, 120V, 60Hz 100V, 50/60 Hz
Overpressure valve:	Opening at approx. 16-18 bar
Water filter:	In tank
Coffee grinder:	Direct current motor with flat ceramic grinder blades
Automatic dosage:	Dose adjustment controlled by the electronic system
Power consumption:	During heating phase- approx. 5.6 A
Dimensions: W x H x D in mm:	215 x 330 x 429 mm (data may vary depending on the model)
Weight:	6.7 kg - 7.5kg (OTC)
Water tank capacity:	1.8 l
Coffee bean hopper capacity:	250 g. / 1 cup
Dreg drawer capacity:	15
Water circuit filling time:	Approx. 15 sec Max. on first filling cycle
Heating time:	Approx. 45 sec.
Grinding time:	Approx. 8-10 sec.

2.2.1. Specification for the measurement of the coffee products temperature.

The temperature is influenced by the flow from the dispenser and stratification of temperatures in the glass. In order to consider these phenomena and to introduce measures that allow comparisons in controlled conditions, below guidelines must be followed:

Conditions:

- Water temperature in tank: 23°C (+/-2°C).
- It must be used a plastic cup (see picture N°1).
- It must be used a thermocouple thermometer (e.g. type K - see picture N°2).
- The coffee machine is tested without any change of parameters or calibrations, which may affect the temperature of products, so the measurement of temperature must be done with machine in default factory setting.

Procedure:

- The temperature must be measured in the cup, immediately after dispensing. Cup has to be placed on a non-metal surface using a thermocouple thermometer (Picture 1).
- The temperature in the cup is measured by immersing the probe of the thermometer up to touch the bottom. The probe then must be moved in a circular motion for 5/6 rotations. At the of the rotations, stop in the center of the cup (Picture 2).
- The highest temperature measured during the rotations is the value we are searching for, and that must be reported;
- Test measurement: from end of dispensing to the end of rotations must be completed within 12 seconds.
- the distance of the probe from the bottom of the glass is a function of the quantity of coffee dispensed: 10mm for 35gr - 17mm for 60gr - 35mm for 120gr and superior (Picture 3).

Limits of acceptability

The acceptance limits are divided by features and products and are the following:

Espresso Coffee Italy Q.ty 25/40 gr.

Temperature of 1st product 69°C ≤ 85°C
Temperature of 2nd product 72°C ≤ 85°C

Coffee Q.ty 70/120 gr.

Temperature of 1st product 69°C ≤ 85°C
Temperature of 2nd product 72°C ≤ 85°C

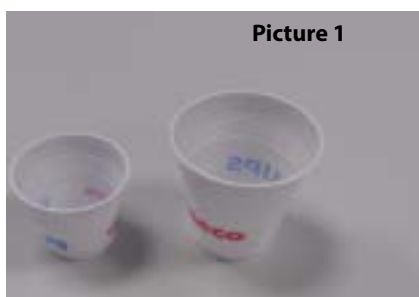

Picture 1



Picture 2

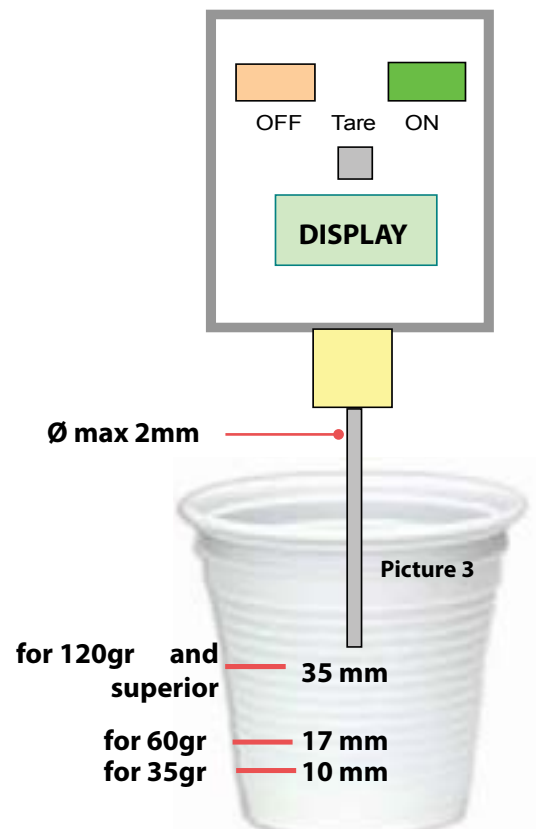

2.2.2. Specification for the measurement of the Milk products temperature.

Milk evaluation

To carry out the test, a partially skimmed UHT milk with a percentage of grease between 1.5-1.8% at a refrigerator temperature T_{refr} . (between 4 to 10°C) must be used.

The milk product must be checked on a beaker of 250 ml of capability and with an inner diameter of 70mm, brewing 100gr of product.

Parameters to be respected:

The parameters to be respected are: milk temperature and height of the cream. Each of these parameters, however, must be evaluated depending on the type of system used for the production of hot milk. Actually three types of devices are present on the appliances:

- Manual system (pannarello)
- Semi-Automatic system (cappuccinatore)
- Automatic system (carafe, Pinless wonder system, etc.)

Milk temperature in the beaker:

System with Pinless Wonder: With milk at T_{refr} . (about 4-10 °C): $\rightarrow \Delta \geq 45$

how does it work:

1. The milk is heated in the first chamber of the carafe thanks to the steam.
2. Then, it is mixed with air and frothed in the middle chamber.
3. Finally, in the outlet chamber, the 'typhoon effect' perfects the milk texture by removing the large bubbles

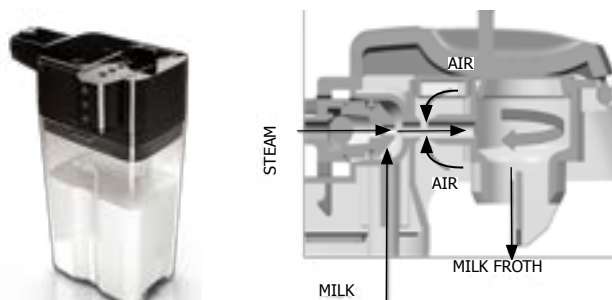

Height of the milk cream in the beaker:

Manual system (pannarello) ≥ 15 mm on 100gr. of brewed product

Semi-automatic system (cappuccinatore) ≥ 20 mm on 100gr. of brewed product

Automatic system: carafe, cappuccinatore, Pinless wonder e.g. (New Royal, Energica Pure, Intelia EVO latte) ≥ 20 mm on 100gr. of brewed product

How to measure the temperature of the milk.

1. The measurement is carried out in the beaker, immediately after the end of milk brew, positioned on a non-metallic surface, using a thermocouple thermometer (eg. Type K). Stop the preparation of mixed product: at the end of milk brewing, where "One Touch product" function is present.
2. The temperature is measured by immersing the probe of the thermometer, positioning the probe inside the beaker at about 10mm from the bottom of the container, then the probe moves in a circular motion for 3-5 turns, stopping at the end, at the center of the beaker. It detects the maximum temperature reached in a time of relief between 3 to 5 seconds. It is important the mixing of milk before the measurement at 10mm from the bottom of the beaker. If the mixing is correct, temperature, for a few fractions of a second, during the measurement should not oscillate.

How to measure the milk cream.

The temperature (T_{refr} or T_{amb}) of the milk doesn't affect as much the test result on measuring the milk cream; by convection is assumed to always use milk at refrigerator temperature T_{refr} .

Manual systems (Pannarello)

Pour 100cc. of milk at T_{refr} . in a beaker of 250 ml of capacity and with a inner diameter of 70 mm; with machine in steam mode:

1. Open the steam knob to discharger water circuit for 4 sec, then close the knob.
2. Place the beaker with the frother dipped in milk, open the steam knob to maximum and start the chronometer.
3. After about 30 to 60 seconds, close the knob and check the result on milk.

Semi-automatic systems (cappuccino)

Pours milk at T_{refr} . in a container ; with the machine in steam mode:

1. Open the steam knob to discharge water circuit for 4 sec. then close the knob.
2. Insert the silicone tube in the milk container, placing a beaker of 250 ml capacity and with an inner diameter of 70 mm under the cappuccino maker and open the steam knob.
3. After having provided 100gr. of product, close the knob and check the result obtained on milk.
Note: The same applies to machines which have a steam key on the user interface and a solenoid valve in place of the steam tap.

Automatic: Carafe, Cappuccino Pinless wonder e.g.:(New Royal, Energica Pure, Intelia EVO Latte), etc..

After setting the machine to delivery of 100gr. of product:

1. Launch the "hot milk" function.
2. Collect the product in a beaker with a 250ml of capacity and with an inner diameter of 70 mm, and verify the result obtained on milk. Carry out the test using milk at a T_{refr} .

In case the machine allows modify of the emulsion through the menu, use the machine with the emulsion set to the default value.

Related to the above testing procedure derives the following table of acceptability:

Manual, Semi-Automatic and Automatic's Milk System	
Grams of Product	Minimun Height of the milk cream
≥ 130	≥ 30mm
120	≥ 25mm
110	≥ 22mm
100	≥ 20mm
90	≥ 16mm
80	≥ 13mm
70	≥ 11mm

NB: To verify more accurately the height of the cream, a practical expedient dictated by experience is to add to the product just delivered a small amount of coffee. The addition of coffee immediately put in evidence the surface of separation between liquid and cream.

2.3. Machine parameters and performance

PRODUCT QUANTITY	Default quantity (Grams)	User programmable	Programm. by Production / Service
Espresso	40 +/- 10gr	Yes	No
Espresso lungo	120 +/- 10%	Yes	No
Classic coffee	Min.145 Max.190	Yes	No
Hot water	Continues until the water supply has been exhausted (capacitive sensor)		
Steam pannarello (frother)	Continues until the water supply has been exhausted (capacitive sensor)		

Descaling cycle frequency			
Hardness	Water hardness	Without water filter	With water filter
1	Soft (up to 7°dH)	240 litres (480,000 pulses)	480 litres (960,000 pulses)
2	Medium (7° - 14°dH)	120 litres (240,000 pulses)	240 litres (480,000 pulses)
3	Hard (15° - 21°dH)	60 litres (120,000 pulses)	120 litres (240,000 pulses)
4	Very hard (over 21°dH)	30 litres (60,000 pulses)	60 litres (120,000 pulses)

The default water hardness level is 4. Each litre of water corresponds to approximately 2,000 pulses.

In the machines where is not possible change the water hardness the default hardness level is 3.

DREG DRAWER	Description and values
Time-out for dreg drawer	5 sec.
Reset dreg counter	Dreg emptying alarm, if the dreg drawer is removed for more than 5 seconds.

STANDBY	Description and values
Inlet time (default)	15 minutes
Inlet time programmed by Production/Service	Yes
Boiler temperature during Standby	Boiler OFF

WATER TANK	Description
Water reserve (pulses) with water filter	200
Water reserve (pulses) with no water filter	200
Water reserve modifiable by Production/Service departments	No
"Fill tank" alarm	Yes
"No tray" alarm	Yes (Fill tank)
Water mains	No

CHAPTER 3

USER INSTRUCTIONS

3.1. Customer menu in the Philips 4000 OTC

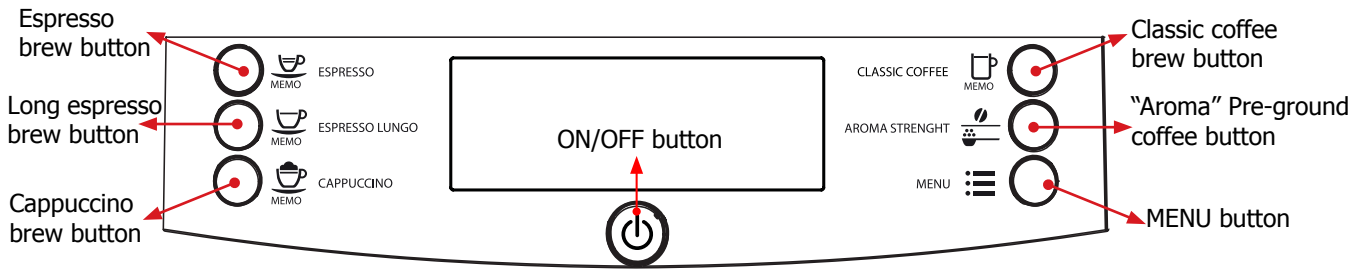

This machine is equipped with a colour-coded system to make your understanding of the display signals easier.

The icons are colour-coded according to the traffic light principle.

Ready Signals (Green Colour)

	The machine is ready to brew products.		The machine is programming the amount of espresso to be brewed.
			The machine is programming the amount of long espresso to be brewed.
	The machine is warming up to dispense beverages.		The machine is programming the amount of classic coffee to be brewed.
	The machine is ready to brew pre-ground coffee.		Espresso brewing using pre-ground coffee in progress.
			Long espresso brewing using pre-ground coffee in progress.
	The machine is brewing one cup of espresso.		Classic coffee brewing using pre-ground coffee in progress.
	The machine is brewing one cup of long espresso.		Water dispensing.
	The machine is brewing one cup of classic coffee.		Frothed milk dispensing.
	The machine is brewing two cups of espresso.		The machine is frothing milk for a cappuccino.
	The machine is brewing two cups of coffee.		The machine is brewing coffee for a cappuccino.



The machine is programming the amount of milk to be dispensed for a cappuccino.



The machine is programming the amount of coffee to be brewed for a cappuccino.



The machine is programming the amount of milk to be dispensed for frothed milk.



Insert the water dispensing spout and press the "MEMO" button to start dispensing. Press "MEMO" to exit.



The machine reminds you to insert the carafe and remove the dispensing spout.

Warning Signals (Yellow Colour)



The machine is warming up.



The machine is performing the rinse cycle. Wait until the machine has completed the cycle.

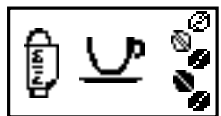

The machine needs the "INTENZA+" water filter to be replaced.

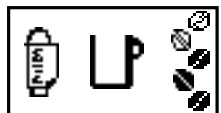

The brew group is being reset due to machine reset.



Fill the coffee bean hopper with coffee beans and restart the cycle.



The machine is priming the circuit.



You need to descale the machine. Press the "MEMO" button to start the descaling process. Follow the steps described in the "Descaling" chapter of this manual.

If you want to descale the machine later, press the "MEMO" button to continue using the machine. Please note that not descaling your machine will ultimately make it stop working properly. In this case, repair is NOT covered under your warranty.

Warning Signals (Red Colour)



Completely insert the drip tray with the coffee grounds drawer into the machine and close the service door.



The brew group must be inserted into the machine.

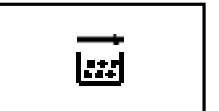

Empty the coffee grounds drawer. Wait 5 seconds before reinserting it.



Fill the coffee bean hopper.

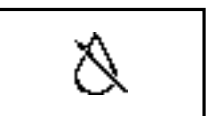

Fill the water tank.



Set the "ESPRESSO" or "COFFEE" selection lever to "COFFEE" within 30 seconds to complete brewing.



Set the "ESPRESSO" or "COFFEE" selection lever to "ESPRESSO" within 30 seconds to complete brewing.

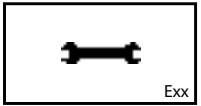

The machine is out of order. The error code is displayed in the right bottom corner. For error codes 1 -3 - 4 - 5, please refer to the "Troubleshooting" chapter. For any other error codes, follow the instructions below: Turn off the machine. Turn it back on after 30 seconds. Try this 2 or 3 times.

3.2. Customer menu in the Philips 4000 AMF

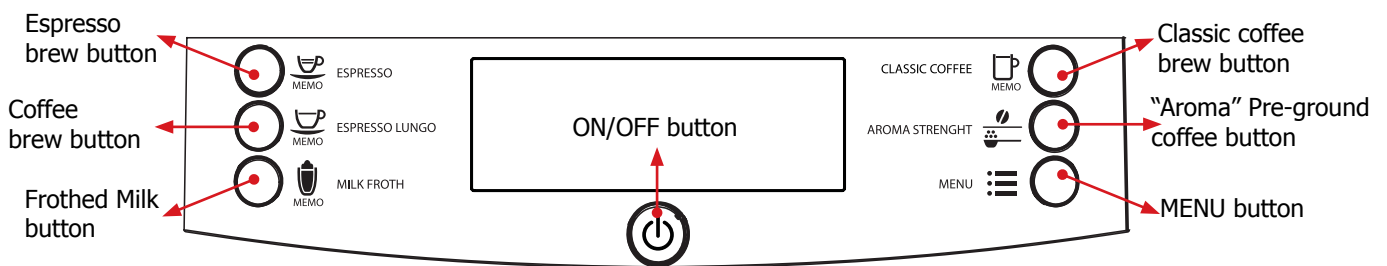

This machine is equipped with a colour-coded system to make the user's understanding of the display signals easier.

The icons are colour-coded according to the traffic light principle.

Ready Signals (Green Colour)



The machine is ready to brew products.

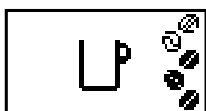

The machine is ready to brew pre-ground coffee.



The machine is warming up to dispense beverages.

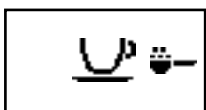

The machine is ready to brew pre-ground coffee.



The machine is ready to brew pre-ground coffee.



Water dispensing.



Frothed milk dispensing.



The machine is brewing one cup of espresso.



The machine is brewing one cup of long espresso.

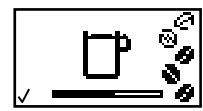

The machine is brewing one cup of classic coffee.



The machine is brewing two cups of espresso.



The machine is brewing two cups of long espresso.



The machine is programming the amount of espresso to be brewed.



Espresso brewing using pre-ground coffee in progress.



The machine is programming the amount of long espresso to be brewed.



Long espresso brewing using pre-ground coffee in progress.



The machine is programming the amount of classic coffee to be brewed.



Classic coffee brewing using pre-ground coffee in progress.

Warning Signals (Yellow Colour)



The machine is warming up.



The brew group is being reset due to machine reset.



The machine is performing the rinse cycle. Wait until the machine has completed the cycle.



Fill the coffee bean hopper with coffee beans and restart the cycle.

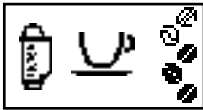

The machine needs the "INTENZA+" water filter to be replaced.



Prime the circuit.



You need to descale the machine. Press the "MEMO" button to start the descaling process. Follow the steps described in the "Descaling" chapter of this manual. If you want to descale the machine later, press the "MEMO" button to continue using the machine.



Please note that not descaling your machine will ultimately make it stop working properly. In this case, repair is NOT covered under your warranty.

Warning Signals (Red Colour)



Completely insert the drip tray with the coffee grounds drawer into the machine and close the service door.



Fill the water tank.



Fill the coffee bean hopper.



Set the "ESPRESSO" or "COFFEE" selection lever to "COFFEE" within 30 seconds to complete brewing.



The brew group must be inserted into the machine.



Set the "ESPRESSO" or "COFFEE" selection lever to "ESPRESSO" within 30 seconds to complete brewing.

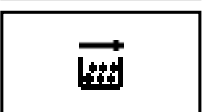

Empty the coffee grounds drawer. Wait 5 seconds before reinserting it.



The machine is out of order. The error code is displayed in the right bottom corner. For error codes 1 -3 - 4 - 5, please refer to the "Troubleshooting" chapter. For any other error codes, follow the instructions below: Turn off the machine. Turn it back on after 30 seconds. Try this 2 or 3 times.

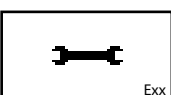

3.3. Customer menu in the Philips 4000 AMF

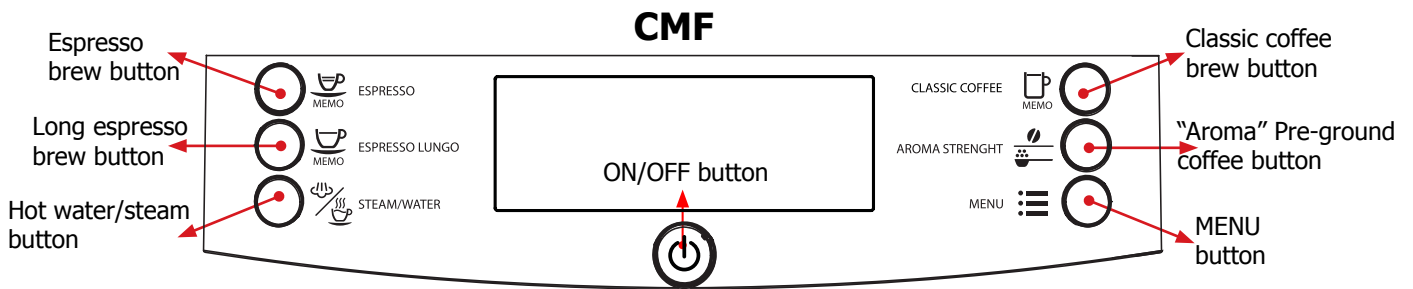

Ready Signals (Green Colour)

- | | | | |
|--|--|--|---|
| | The machine is ready to brew products. | | The machine is brewing one cup of classic coffee. |
| | | | The machine is brewing two cups of espresso. |
| | The machine is warming up to brew beverages or dispense hot water. | | The machine is brewing two cups of long espresso. |
| | | | The machine is programming the amount of espresso to be brewed. |
| | The machine is ready to brew pre-ground coffee. | | The machine is programming the amount of long espresso to be brewed. |
| | Water dispensing. | | The machine is programming the amount of classic coffee to be brewed. |
| | Steam dispensing. | | Espresso brewing using pre-ground coffee in progress. |
| | The machine is brewing one cup of espresso. | | Long espresso brewing using pre-ground coffee in progress. |
| | The machine is brewing one cup of long espresso. | | Classic coffee brewing using pre-ground coffee in progress. |

Warning Signals (Yellow Colour)

Warning Signals (Yellow Colour)



The machine is warming up.



The brew group is being reset due to machine reset.



The machine is performing the rinse cycle. Wait until the machine has completed the cycle.

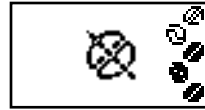

Fill the coffee bean hopper with coffee beans and restart the cycle.

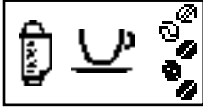

The machine needs the "INTENZA+" water filter to be replaced.



Prime the circuit.



You need to descale the machine. Press the "☺☺☺" button to start the descaling process. Follow the steps described in the "Descaling" chapter of this manual. If you want to descale the machine later, press the "☺☺☺ MEMO" button to continue using the machine.



Please note that not descaling your machine will ultimately make it stop working properly. In this case, repair is NOT covered under your warranty.

Warning Signals (Red Colour)



Completely insert the drip tray with the coffee grounds drawer into the machine and close the service door.



Fill the water tank.

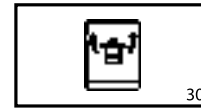

Set the "ESPRESSO" or "COFFEE" selection lever to "COFFEE" within 30 seconds to complete brewing.



Fill the coffee bean hopper.



Set the "ESPRESSO" or "COFFEE" selection lever to "ESPRESSO" within 30 seconds to complete brewing.



The brew group must be inserted into the machine.

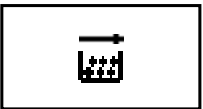
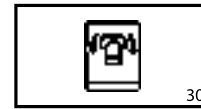

Empty the coffee grounds drawer. Wait 5 seconds before reinserting it.

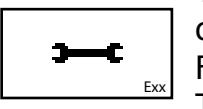
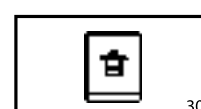

The machine is out of order. The error code is displayed in the right bottom corner. For error codes 1 -3 - 4 - 5, please refer to the "Troubleshooting" chapter. For any other error codes, follow the instructions below: Turn off the machine. Turn it back on after 30 seconds. Try this 2 or 3 times.

3.4. Customer menu in the Philips 3000 AMF

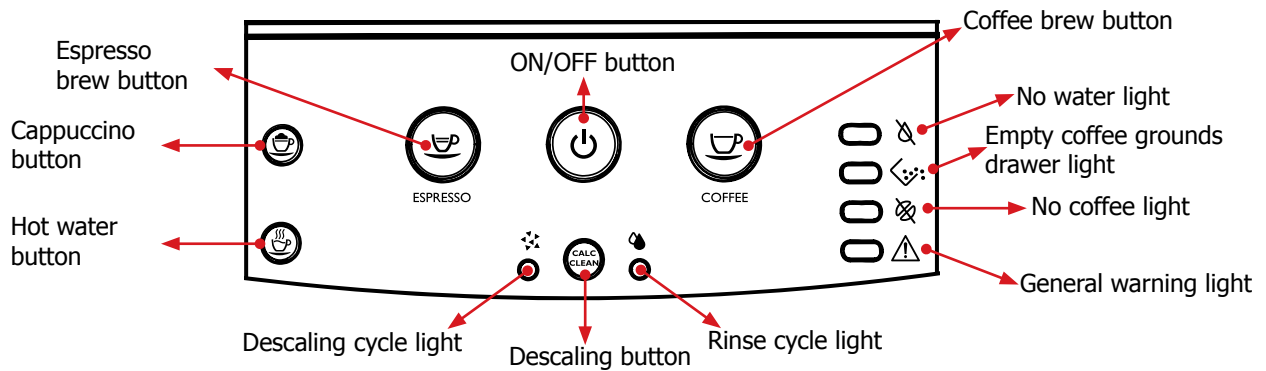

Warning Signals



The machine is performing one of the following operations:
 - Warm-up
 - Automatic rinse.

Flashing



The machine needs to prime the circuit. Press the "☕" button. Once pressed, the button turns off. The "⚡" and "⚠️" lights flash while the circuit is being primed, and they turn off once priming has been completed.

"☕" steady on "⚡" and "⚠️" flashing



The machine is ready for product brewing.

Steady on

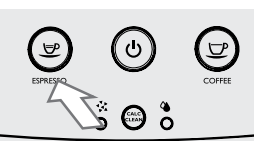

The machine is brewing one cup of espresso.

Flashing slowly



The machine is brewing one cup of coffee.

Flashing slowly



The machine is brewing two cups of espresso.

Quick double flashing



The machine is brewing two cups of coffee.

Quick double flashing



The machine is programming the amount of espresso to be brewed.

Flashing quickly

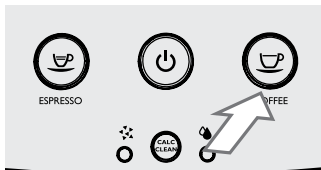

The machine is programming the amount of coffee to be brewed.

Flashing quickly



The machine is in the steam dispensing phase.

Flashing slowly



The machine is in the hot water dispensing phase.

Flashing slowly

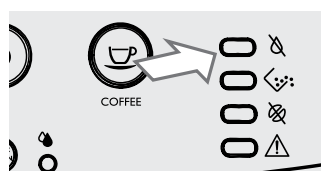

Fill the water tank.

Steady on



Completely insert the drip tray with the coffee grounds drawer into the machine and close the service door.

Steady on



The brew group is being reset due to machine reset.

Flashing quickly



Insert the brew group.

Flashing slowly

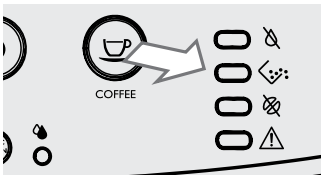

Empty the coffee grounds drawer.

Steady on

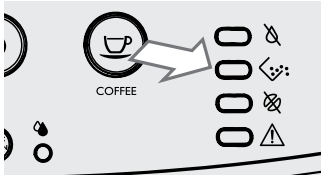

The coffee grounds drawer is not inserted into the machine. Wait a few seconds until the “☞” light turns off and the “⚠” light shines steadily. Then insert the coffee grounds drawer and close the service door.

Flashing

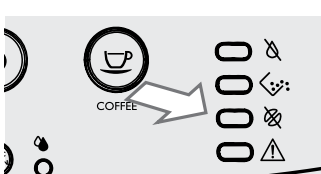

Fill the coffee bean hopper with coffee beans and restart the brewing cycle. The light turns off when the brew button of the selected product is pressed.

It is possible to dispense steam and hot water when this warning message appears.

Steady on

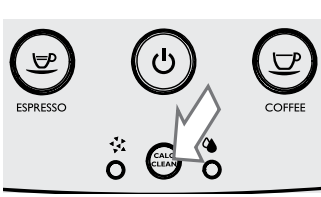

You need to descale the machine. Follow the steps described in the “Descaling” chapter of this manual.

Please note that not descaling your machine will ultimately make it stop working properly. In this case repair is NOT covered under your warranty.

Steady on



Your machine is out of order.

Turn off the machine. Turn it back on after 30 seconds.

Repeat the procedure 2 or 3 times. If the machine does not start, contact the Philips hotline in your country (contact details in the warranty booklet).

All lights flashing simultaneously

3.5. Customer menu in the Philips 3000 CMF

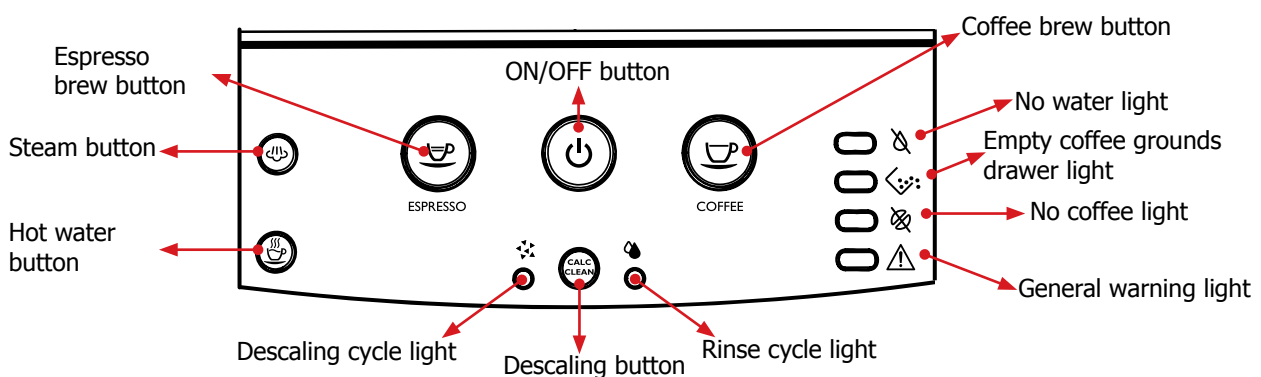

Warning Signals



The machine is performing one of the following operations:
 - Warm-up
 - Automatic rinse.

Flashing

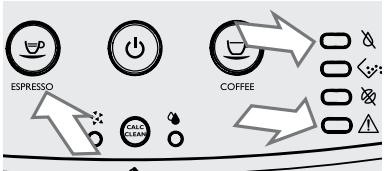

The machine needs to prime the circuit.
 Press the "☕" button. Once pressed, the button turns off .
 The "⚡" and "⚠" lights flash while the circuit is being primed, and they turn off once priming has been completed.

"☕" steady on "⚡" and "⚠" flashing



The machine is ready for product brewing.

Steady on

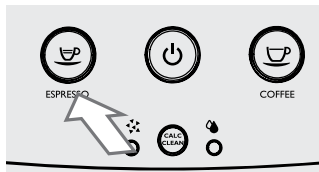

The machine is brewing one cup of espresso.

Flashing slowly



The machine is brewing one cup of coffee.

Flashing slowly

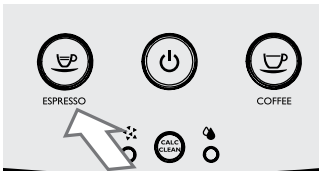

The machine is brewing two cups of espresso.

Quick double flashing



The machine is brewing two cups of coffee.

Quick double flashing

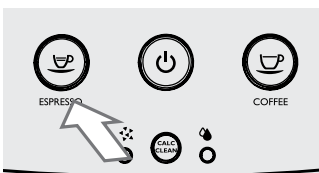

The machine is programming the amount of espresso to be brewed.

Flashing quickly

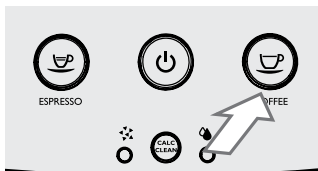

Flashing quickly

The machine is programming the amount of coffee to be brewed.



Flashing slowly

The machine is in the steam dispensing phase.



Flashing slowly

The machine is in the hot water dispensing phase.

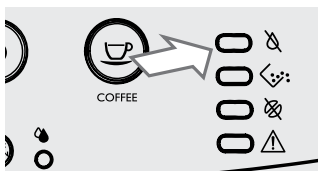

Steady on

Fill the water tank.



Steady on

Completely insert the drip tray with the coffee grounds drawer into the machine and close the service door.

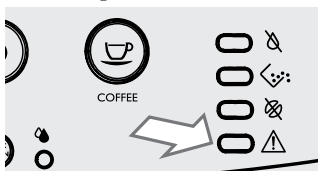

Flashing quickly

The brew group is being reset due to machine reset.

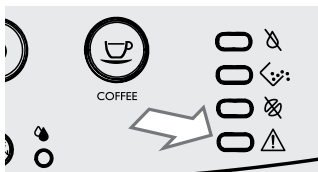

Flashing slowly

Insert the brew group.

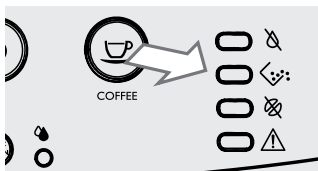

Steady on

Empty the coffee grounds drawer.

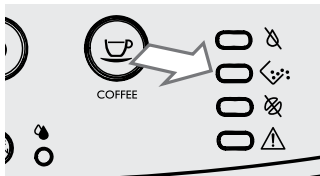

The coffee grounds drawer is not inserted into the machine. Wait a few seconds until the "☕" light turns off and the "⚠" light shines steadily. Then insert the coffee grounds drawer and close the service door.

Flashing

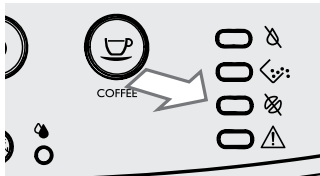

Fill the coffee bean hopper with coffee beans and restart the brewing cycle. The light turns off when the brew button of the selected product is pressed.

It is possible to dispense steam and hot water when this warning message appears.

Steady on

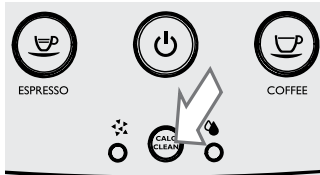

You need to descale the machine. Follow the steps described in the "Descaling" chapter of this manual.

Please note that not descaling your machine will ultimately make it stop working properly. In this case repair is NOT covered under your warranty.

Steady on

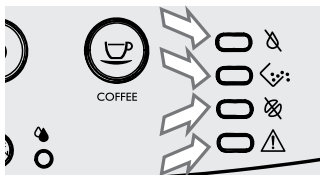

Your machine is out of order.

Turn off the machine. Turn it back on after 30 seconds.

Repeat the procedure 2 or 3 times.

If the machine does not start, contact the Philips hotline in your country (contact details in the warranty booklet).

All lights flashing simultaneously

3.6. Operation, cleaning and maintenance

Operating the machine		
1	Fill water tank	
2	Fill the coffee bean hopper	
3	Switch on the appliance	
4	Press the button to start the appliance	
5	Heating	When the heating phase begins, wait for it to finish
6	Rinse	Carry out a rinse cycle for the internal circuits
7	Machine ready	The machine is ready to dispense beverages

CLEANING AND TECHNICAL SERVICING		
A	Empty the dregs drawer	When indicated
B	Empty the drip tray	As necessary
C	Clean the water tank	Weekly
D	Clean the coffee bean hopper	As necessary
E	Clean the casing	As necessary
F	Clean the brewing unit	Every time the coffee bean hopper is filled or weekly
	Lubricate the brewing unit	After 500 dispensing cycles or when the grease is no longer present on the brewing unit
	Clean the unit housing	Weekly
H	Descaling	When indicated

Descaling cycle frequency			
Hardness	Water hardness	Without water filter	With water filter
1	Soft (up to 7°dH)	240 litres (480,000 pulses)	480 litres (960,000 pulses)
2	Medium (7° - 14°dH)	120 litres (240,000 pulses)	240 litres (480,000 pulses)
3	Hard (15° - 21°dH)	60 litres (120,000 pulses)	120 litres (240,000 pulses)
4	Very hard (over 21°dH)	30 litres (60,000 pulses)	60 litres (120,000 pulses)

CHAPTER 4

OPERATING LOGIC

4.1. Water circuit Philips 4000 - 3000

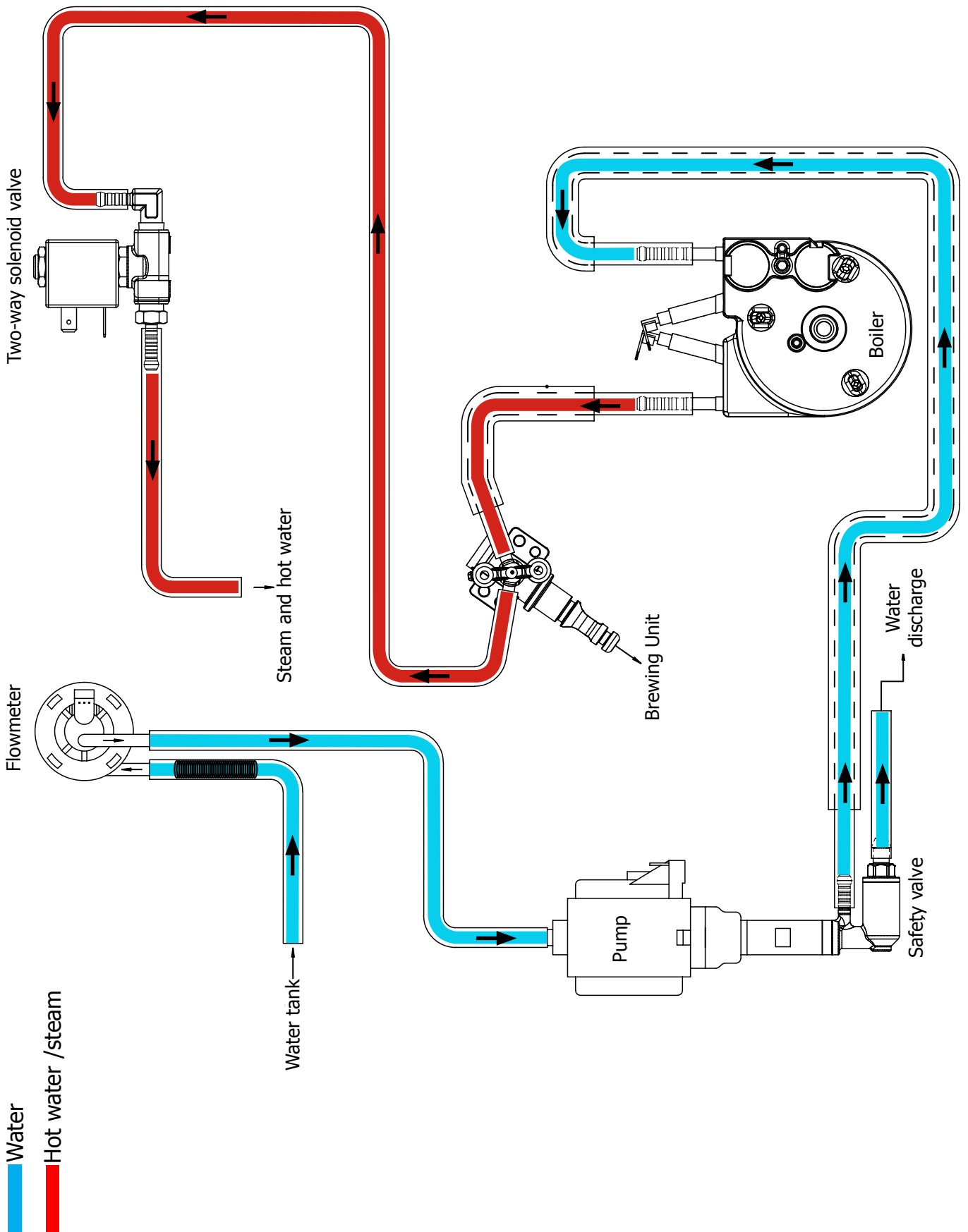

4.2. Milk Carafe 4000 OTC

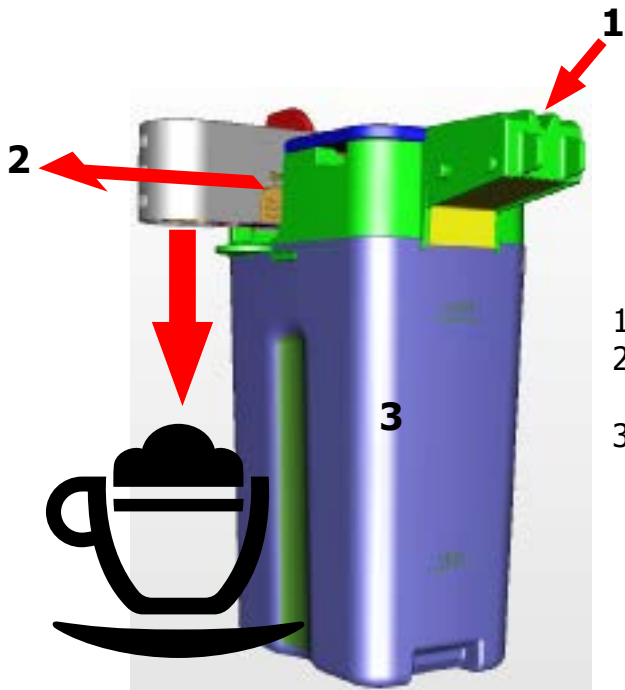

- 1) Steam input
- 2) Bring the cappuccino maker into dispensing position
- 3) Milk tank

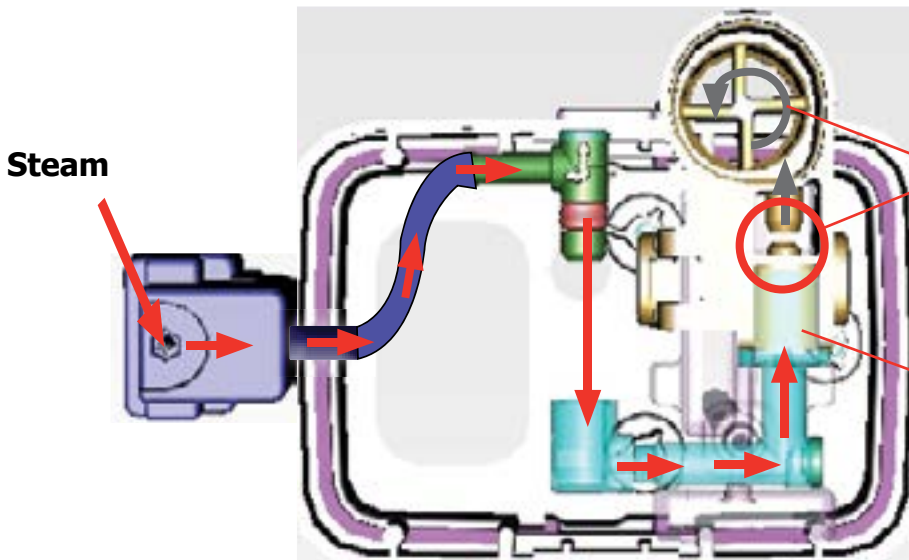

The milk is heated by the steam and taken towards the emulsion chamber where it is mixed with air and transformed into foam

The steam passes through the pipe creating a sucking effect that pulls the milk upwards

4.3. Single microswitch

Switching on

When the machine is switched on, the gear motor repositions itself as follows:

- It acts on microswitch 1
- The gear motor changes its rotation direction and moves upwards again by approx. 1-2 mm.
- The boiler begins to heat the water for approx. 45 sec., at full power, in order to reach the optimal temperature. The temperature will then remain at a constant level.

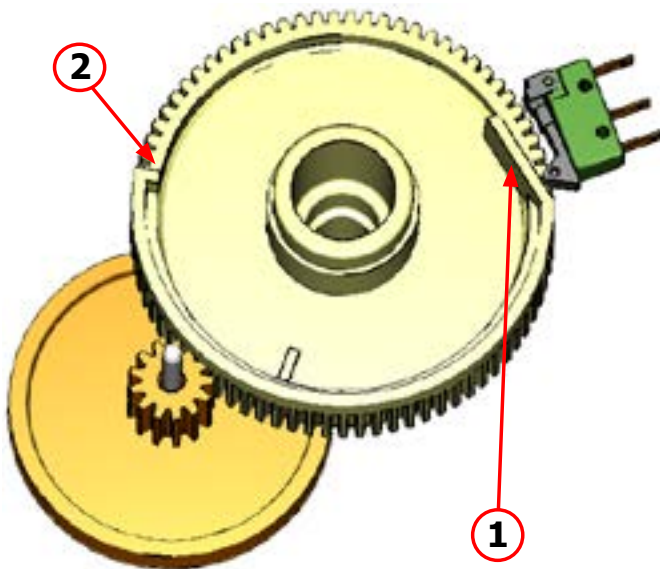

The gear motor is powered by a direct current motor that engages with the smaller double toothed wheel using a worm screw. The unit is mounted on the axle of the large gear wheel and when a coffee is requested, it moves from the standby position to the dispensing position, and then back to the standby position again.

- **Standby position: 1**

- **Dispensing position: 2**

4.7. Temperature sensor (adjustment)

Temp. (°C)	R nom (kΩ)	ΔR (+/- %)
20	61.465	8.6
50	17.599	5.9
75	7.214	4.1
80	6.121	3.7
85	5.213	3.4
90	4.459	3.1
100	3.3	2.5
125	1.653	3.9
150	0.893	5.1

An NTC is used as a temperature sensor; in the event of overheating this reduces boiler element power consumption.

The electronic system detects the current boiler temperature from the drop in voltage of the sensor and adjusts it accordingly.

Heating element values and corresponding temperatures: see table.

4.4. Coffee grinder Philips 4000

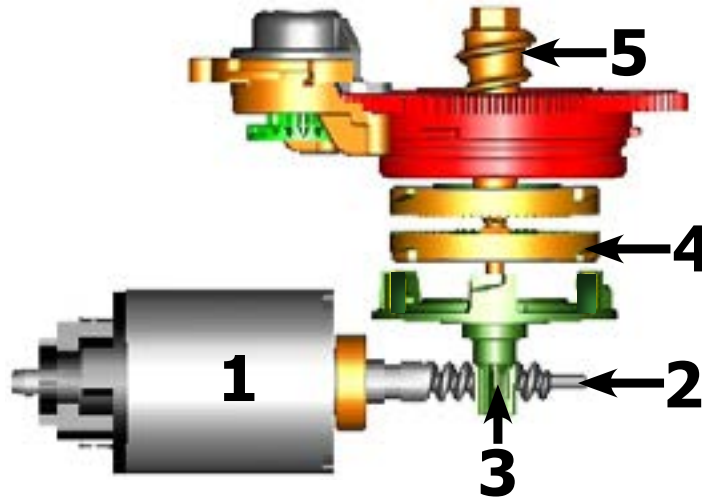

The coffee grinder is driven by a direct current motor (1) using a worm screw helicoidal wheel transmission (2). The worm screw (2) drives a plastic gear wheel (3), which turns the lower grinder (4) and the increment pin (5)

4.4.1 Autodose system description

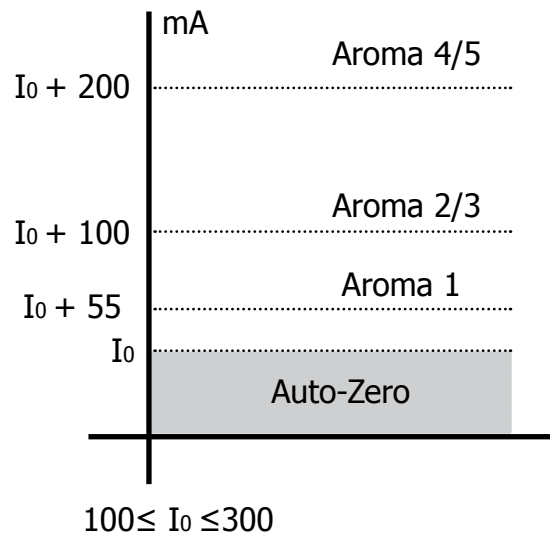

I_0 = current when the BU is moving without load, i.e. without coffee. It occurs, for example, during the rinsing phase of coffee spout.

Current targets:

- Aroma 1 → 55mA
- Aroma 2/3 → 100mA
- Aroma 4/5 → 200mA
- $100 \text{ mA} \leq I_0 \leq 300 \text{ mA}$

If the BU current is \leq the current target → the grinding time ↑
 If the BU current is \geq the current target → the grinding time ↓

1) When the system get the stability (i.e. the system got the current target) the coffee doses should be:

A1	A2/3	A4/5	
7,5	9,0	10	±1,5 grams





with medium grinding (500±60µm) and using coffee of test.

2) the 3 grinding times are always:

$$T_1 < T_2 < T_3$$

beside, every grinding time is, respectively:

- 4,0s ≤ T₃ ≤ 10s (10000ms)
- 3,5s ≤ T₂ ≤ 9s (9000ms)
- 3,0s ≤ T₁ ≤ 8,1s (8100ms)

5 levels		DOSE ADJUSTMENT			
		Grinder Time	Min Grinder Time	Max Grinder Time	Curret target
Aroma of the grinded product	Aroma1  Very Light	T ₁	3s	8,1s	I ₀ + 55mA
	Aroma2  Light	T ₂	3,5s	9s	I ₀ + 100mA
	Aroma3  Med				
	Aroma4  Strong	T ₃	4s	10s	I ₀ + 200mA
	Aroma5  Very Strong				

4.4.2. Coffee lack detection and coffee grinder blocked

The machine uses an **ALGORITHM** that considers the **current absorbed** by the coffee grinder, beside it considers if the grinder is old or new and if it is warm or cold.

4.5. Coffee cycle

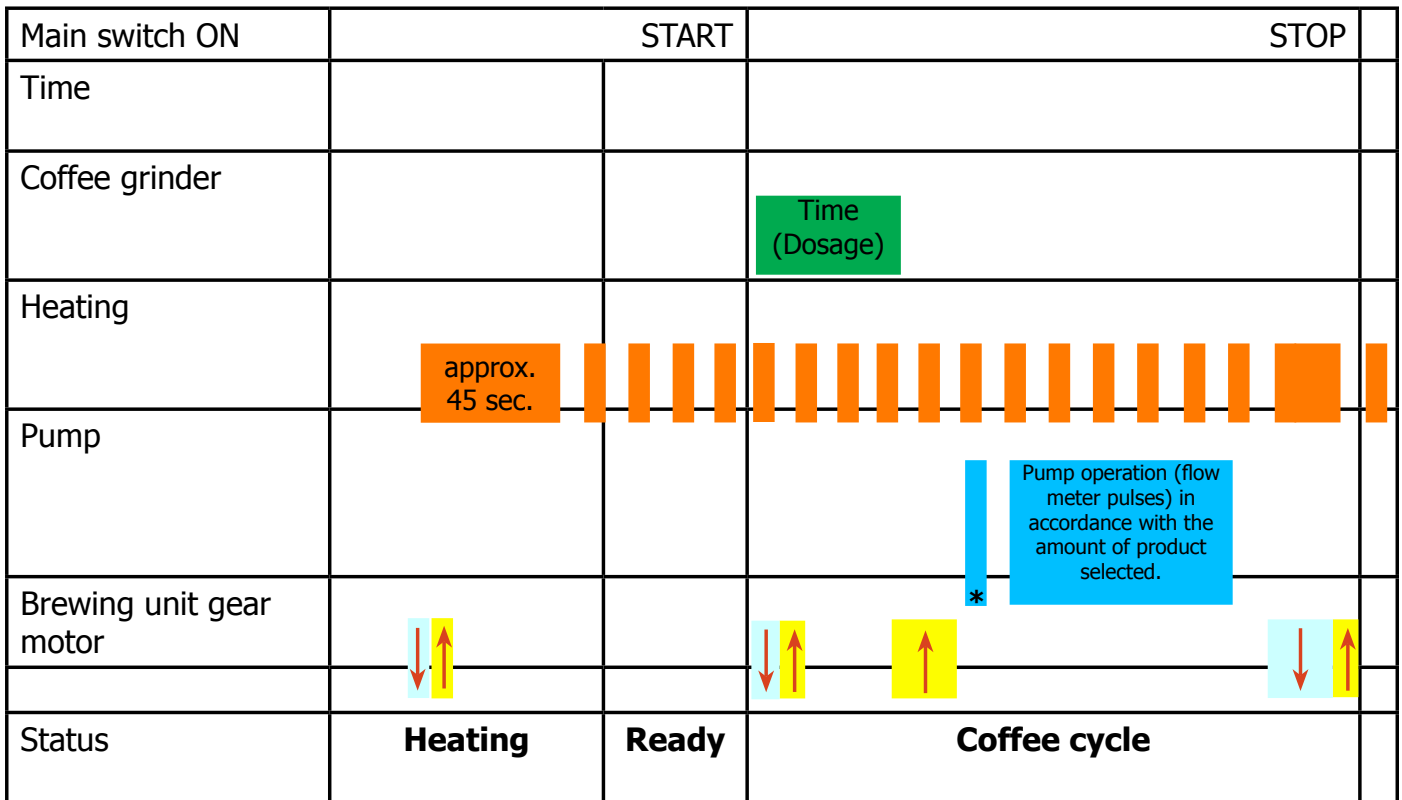

Notes: * Only with Pre-brewing



Single microswitch gear motor

Switching on

When the machine is switched on, the gear motor repositions itself as follows:

- It acts on microswitch 1 (see following chapter).
- The gear motor changes its rotation direction and moves upwards again by approx. 1-2 mm.
- The boiler begins to heat the water for approx. 45 sec., at full power, in order to reach the optimal temperature. The temperature will then remain at a constant level.

Coffee cycle

1. The coffee grinder starts the grinding process (controlled by Time).
2. The gear motor (brewing unit) moves to the brewing position.
3. Preliminary dispensing phase (short pump activity, short pause).
4. Product dispensing (the pump operation period is defined by the amount of product dispensed).
5. The gear motor moves to its home position (the dregs are expelled automatically).

4.5.1. Coffee grinder Philips 3000

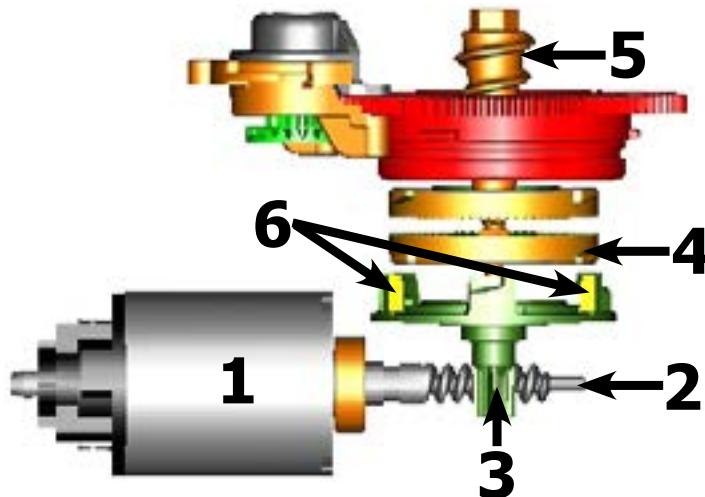

The coffee grinder is driven by a direct current motor (1) using a worm screw helicoidal wheel transmission (2).

The worm screw (2) drives a plastic gear wheel (3), which turns the lower grinder (4) and the increment pin (5)

There are two magnets (6) in the gear wheel; at every rotation these induce two pulses to a Hall sensor, which in turn transmits them to the electronic system.

4.5.2. Low bean level detection, dose quantity adjustment, coffee grinder blocked

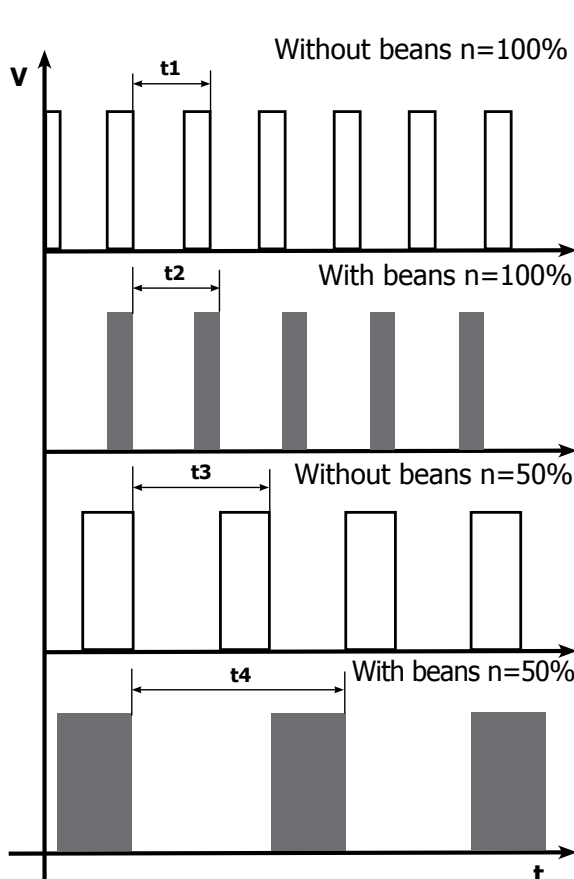

No coffee

A low coffee bean level is detected by the Hall sensor, after variations in the pulse frequency (with or without coffee).

If there are no coffee beans (operation while empty), the number of rotations – and therefore the number of pulses – will be greater.

t1 = no coffee indication

If, however, there are coffee beans, the number of rotations will be lower due to the force created by the grinding.

t2 = no indication

t3 and t4 = this measurement is performed at the end of each grinding process

Dose quantity adjustment

The dose quantity is adjusted in accordance with the pulses detected (number of rotations proportional to the selected flavor – mild, medium or strong).

Coffee grinder blockage

If the coffee grinder becomes blocked for any reason, pulses will no longer be transmitted to the electronic system and the grinder will come to a stop.

4.5.3. Dose self-learning (SAS)

The aim of this function is to automatically regulate the average dose of ground coffee (SELF-LEARNING); this takes place with an algorithm based on the following values and setting by the user:

1. Number of coffee grinder pulses during the grinding cycle.
2. Max. average value of the power consumed by the gear motor during the coffee brewing cycle.
3. Aroma selected by the user.

The algorithm compares the maximum average value of the power consumed by the gear motor with the value listed in the table for the selected aroma, in order to calculate the new grinding pulse value for the next coffee produced.

If the power consumption value is less than the minimum current value, the grinding pulses will be increased by 2.

If the power consumption value is greater than the maximum current value, the grinding pulses will be decreased by 4.

If the power consumption value falls within the "over-torque" interval, the product will be dispensed and the grinding pulses will be decreased by 10.

If the power consumption value falls within the "abort cycle" interval, the dreg will be expelled and the grinding pulses will be decreased by 10.

If the "pre-ground" flavour is selected by the user, no modification will be made.

This guarantees that, regardless of the coffee type used, the grinding level setting and the wear on the grinders, the ground coffee dose always remains constant.

			DOSE ADJUSTMENT (NUMBER OF GRINDER IMPULSES) TO APPLY TO MED AROMA					
		3 levels	5 levels	+2	0	-4	-10	-10 and CYCLE ABORTED
Aroma of the grinded product	A	Light	Very Light	MAX_CURRENT_mA <150mA	<=150mA MAX_CURRENT_mA <=250mA	MAX_CURRENT_mA >250mA	MAX_CURRENT_mA >800mA	MAX_CURRENT_mA >1000mA
		B	Med	Light	MAX_CURRENT_mA <250mA	<=250mA MAX_CURRENT_mA <=350mA	MAX_CURRENT_mA >350mA	MAX_CURRENT_mA >800mA
	C		Strong	Med	MAX_CURRENT_mA <350mA	<=350mA MAX_CURRENT_mA <=500mA	MAX_CURRENT_mA >500mA	MAX_CURRENT_mA >800mA
		Strong		Very Strong				

Important:

For perfect operation, machine adjustment should take place in the area of the fields highlighted in green (A, B, C). When the type or brand of coffee is changed, there may be variations in the size of the beans and their stickiness or roasting level. This leads to variations in power consumption (mA), with resulting excessive or insufficient doses (until the necessary adjustments have been made to compensate for this change).

Caution: In the case of excessive dosage, powder may be expelled into the dreg drawer. This is not a fault, but can occur during preliminary operation or after a service.

4.6. Water level detection (water tank)

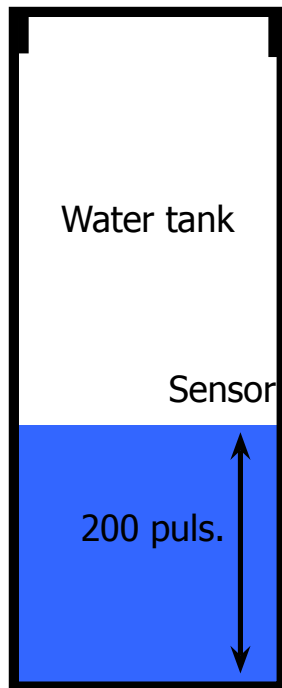

“Water low” message (water reserve)

Function:

The water level is monitored by a capacitive sensor, located one third of the way up the water tank wall.

If the electronics assembly detects, by means of the sensor, that the amount of water in the tank has dropped below the above mentioned level, a water reserve remains available for the dispensing process underway (this will cover 200 flow meter pulses).

The product dispensing process will then come to an end.

If a dispensing cycle ends after the sensor has been triggered (in the reserve) then the display “Water low” continues to be displayed during the following dispensing cycle.

4.7. Descaling request

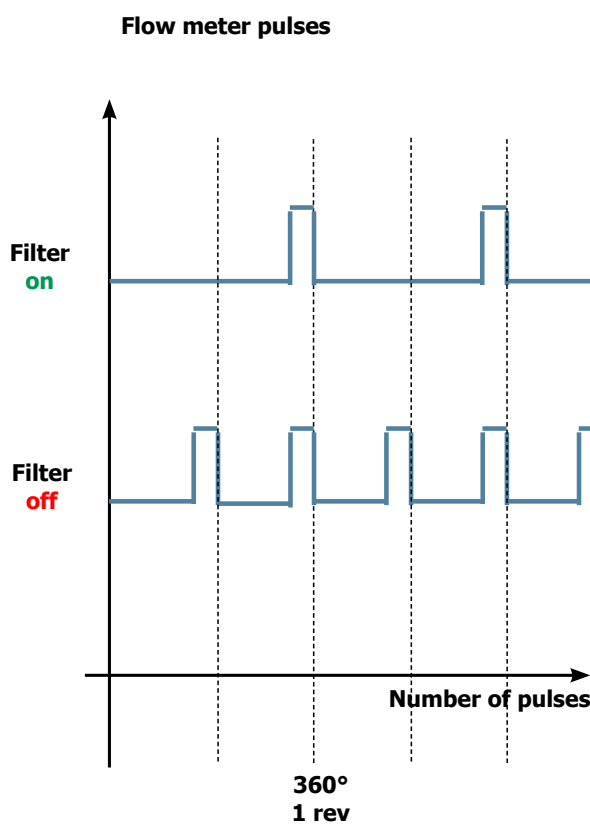

“Descaling” – message with water filter inserted

(appliances with display only)

The water hardness is set on the basis of the regional water hardness analysis (1, 2, 3, 4).

Filter off:

If the function is turned off the electronics assembly monitors the flow meter pulses, recording one pulse each turn.

Filter on:

If the function is turned on the electronics assembly monitors the flow meter pulses, recording one pulse every two turns.

“Change water filter” message

The electronics assembly uses the flow meter impulses to keep track of the amount of water which has flowed through; after the specified amount (set in accordance with the water hardness level), the “Replace filter” message appears.

4.8. Water filter

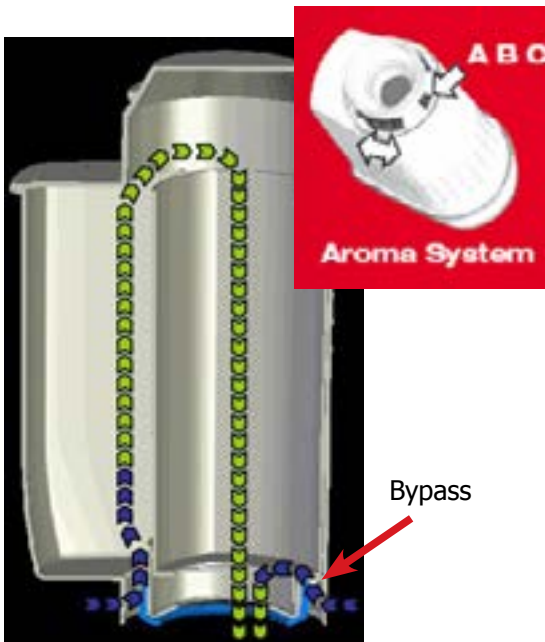
**Function:**

- Reduced limescale deposits which take longer to form.
- Improved water quality.
- Improved taste due to the ideal water hardness.

Life span / descaling performance:

- - 10 ° dH
- 60 litres
- 2 months

To achieve the best possible operating mode consistency over the total life span, the water is channelled using a 3-stage bypass (A, B, C) depending on the degree of hardness. See small image.

CHAPTER 5

TROUBLESHOOTING

5.1. Test Mode Philips 4000.

Introduction

This document describes the Test Mode of the Philips 4000 (CMF,AMF & OTC) Coffee Machine. This application is used in order to test the machine in its mechanics and electronic components.

To enter Test Mode

The machine enters in Test mode by holding pressed together **Z1** and **Z6** buttons while switching on the machine by the main switch on the backside of the CA. Once entered in Test Mode, the display shows the firmware version (Level 0).

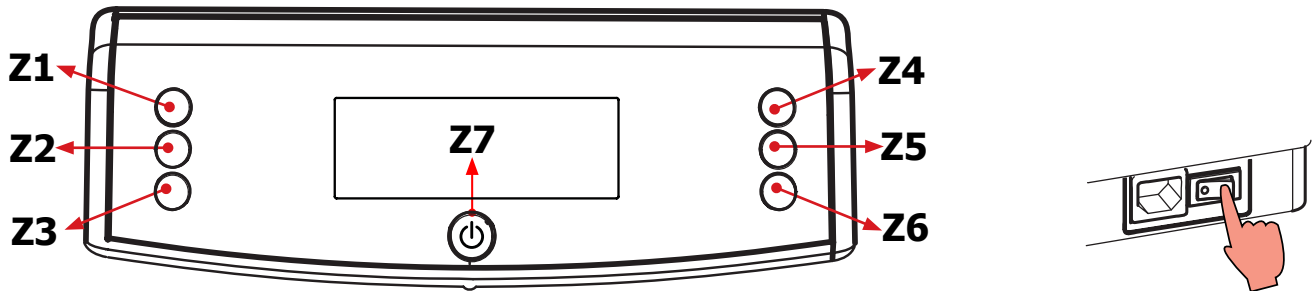

The Test Mode is organized into **6 different** pages, each level the coffee machine can execute different commands:

Page 0: The display shows:

- Firmware version.
- Version of machine (Focus CMF, Class AMF, Top OTC).
- Voltage of PCB.
- Main supply frequency (50 or 60 Hz).

Page 1: Keyboard and display's colour test:

- Z1 button
- Z2 button
- Z3 button
- Z4 button
- Z5 button
- Z6 button
- Z7 button
- Backlight colors

Page 2: Input signals test:

- Water level sensor
- Micro-switch door closed/opened
- Microswitch presence of the Brew Unit

Page 3: Low voltage loads test:

- Brew Unit movement upward and downward (24V DC)

Page 4: High/Low voltage loads test (Pump, E.Valve) :

- Pump (230V AC)
- DC Solenoid valve (24V) (The door must be closed !!)
- Flow-meter

Page 5: High voltage loads test (Heater , Grinder):

- a) Heater (230V AC)
- b) Grinder (320V DC)

The user can change the page by pressing the **Z7** button.
 Page 0 is accessible only entering Test Mode from power-off mode; at the start up all loads are turned off.

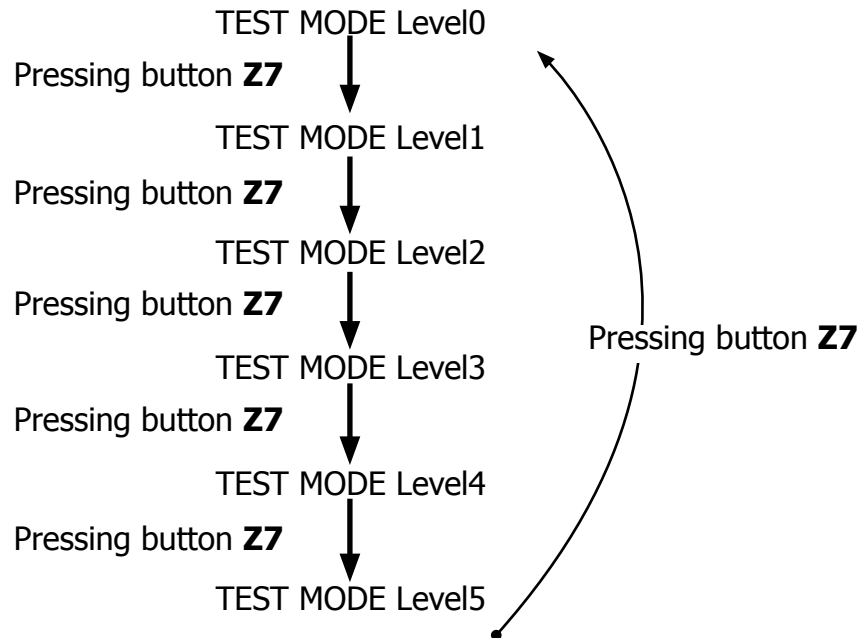

Page 0 (FIRMWARE)

Verify the firmware version



Firmware version on the display.
 The machine model is shown (FOCUS, CLASS or TOP).
 The voltage of the main supply "230V"
 The frequency of the main supply is shown (50 or 60 Hz)

ERROR: If in machine model field is written "Unknow" and backlight of display is Yellow, check the jumper in interface.



The firmware version is the same as the label on MicroController
ERROR: The firmware version is different from the label on MicroController;
 change the CPU_POWER Boards !

Press **Z7** " ⏻ " to move to the next screen



The machine passes to the Page 1 (KEYBOARD)
ERROR: The page does not change; Check the interface board and the flat cable (JP21)

Page 1 (KEYBOARD)



Start condition



Press buttons from 1 to 7

Only when a button is pressed a 0 appears on the relative position of button pressed.

In the middle of display appears the name of the button pressed. Pressing buttons on the left the backlight color changes from GREEN to YELLOW.

Pressing button on the right the backlight color changes from GREEN to RED.

When a button is pressed, also the Stand-By led (RED) turn ON.



Note: Press button Z7 as the last once, since it makes change the test page.

Note: If 2 or more buttons are pressed the name that appears on display could be wrong.

ERROR: If nothing appears on display; check the interface board and the flat cable (JP21).

ERROR: If during the movement the backlight remain green check the wiring (JP1) from the interface board and the display.

ERROR: The name displayed is wrong; check the position of jumper in interface. It must be the same of machine model.

Press **Z7** "  " to move to the next screen



The machine passes to the level 2 (INPUTS)

Page 2 (INPUTS)



Start condition

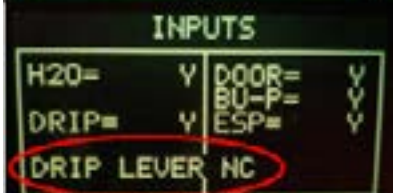

Warning: if the Lever sensor is not connected to interface will appear a warning message.

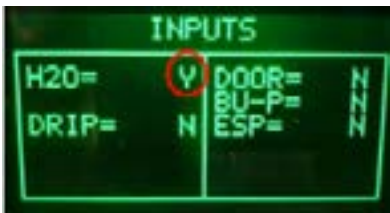

Insert a full Water Tank

The indication **H2O** changes from "N" to "Y".

Note: the switching from "N" to "Y" requires about 1-2 seconds.

ERROR: The indication TANK-H2O doesn't change; check the capacitive sensor (fixing) and the wiring (JP23)



Insert the BrewUnit

The indications **BU-P** changes from "N" to "Y".

Note: removing the BrewUnit the indication from "Y" to "N" requires about 2-3 seconds to switch.

ERROR: Check the BU presence Microswitch and the wiring (JP16).



Close the Door and Dreg Drawer

The indication **DOOR** change from "N" to "Y"

ERROR: The indication **DOOR** does not change; check the Microswitch for the door and the wiring (JP14).

Note: without the Dreg Drawer correctly inserted the DOOR indication cannot change!



Move Lever to Coffee Position

The indication DRIP change from "N" to "Y"

ERROR: The indication **DRIP** does not change; check the Lever sensor, the connector in PCB interface (JP4) or the cabling between Lever sensor and interface



Move the lever in Espresso position

The indication ESP change from "N" to "Y"

ERROR: The indication **ESP** does not change; check the Lever sensor, the connector in PCB interface (JP4) or the cabling between Lever sensor and interface.

Press **Z7** "  " to move to the next screen

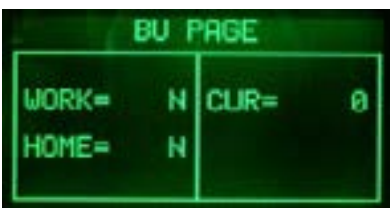

The machine passes to the Page 3 (**BU PAGE**)

Page 3 (BU)



Start condition



Press the Z1 button to move the BU to Work

IMPORTANT NOTE: If the DREGDRAWER is not inserted or the DOOR is not closed the BU test cannot be performed. If these 2 inputs are not in the right position, a warning message will be shown and the display turns to yellow.



When the BU reaches the work position the indication **WORK** changes from "N" to "Y", the number of the current is less than 200mA (without BU) or 300mA (with BU).



ERROR: The indication **WORK** doesn't change and remain "N", the display backlight changes from green to red; Check the work microswitch (broken?), the BU motor (blocked?) and the wiring (JP16).

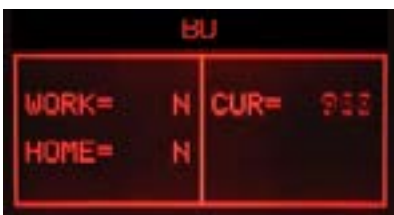

ERROR: (Without BU) The absorbed current is more than 200mA, the display backlight changes from green to red; check the BU and the motor.



ERROR: (With BU) The absorbed current is more than 300mA, the display backlight changes from green to red; check the BU and the motor.



Press the Z3 button to move the BU to Home

When the BU reaches the home position the indication **HOME** changes from "N" to "Y", the number of the current is minus than 200mA (without BU) or 300mA (with BU).



ERROR: The indication **HOME** doesn't change and remain "N", the display backlight changes from green to red; Check the work microswitch (is broken), the BU motor (is blocked) and the wiring (JP16).



ERROR: (Without BU) The absorbed current is higher than 200mA, the display backlight changes from green to red; check the BU and the motor.



ERROR: (With BU) The absorbed current is higher than 300mA, the display backlight changes from green to red; check the BU and the motor

Press **Z7** "  " to move to the next screen

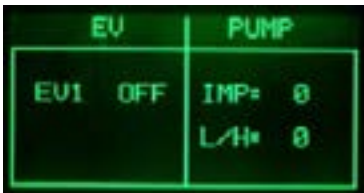

The machine passes to the Page 4 (**EV - PUMP**)

Page 4 (EV - PUMP)

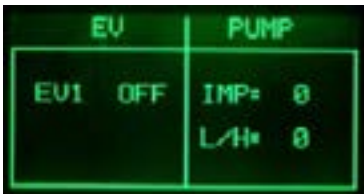

Start condition



Press the Z1 button to open the Electro Valve

IMPORTANT NOTE: If the DREGDRAWER is not inserted or the DOOR is not closed the EV test cannot be performed. If these 2 inputs are not in the right position, a warning message will be shown and the display turns to yellow.



It is possible to hear the "click" from Electro Valve. The indication beside the **EV1** changes from "OFF" to "ON".



Press and Release the Z4 button to switch on the pump (100 impulses)

The water goes out from the pipe and the indication IMP shows increasing numbers. The indication L/H must be within the range 10-18.



ERROR: The display backlight changes from green to red and the impulse remains 0; If water comes out the pipe: check the wiring from the flowmeter to the CPU/POWER board (JP5). If no water comes out the pipe: check the pump and the wiring from the pump to the CPU/POWER board (JP24).



ERROR: The L/H is zero or very low; the Electro Valve does not open. Check the wiring from the Electro Valve to the CPU/POWER board (JP3) and the Electro Valve

Press **Z7** "  " to move to the next screen



The machine passes to the level 5 (Heater-Grinder)



Start condition



Press the Z4 button to switch on the grinder.

The grinder rotates and in the indication **GRINDER** the number increasing up to 5000 (5seconds test). The other numbers inside the **GRINDER** box are not important for this test.

7000	7 sec. grinding in medium aroma (the number can vary during operation of the machine)
5000	5 sec. grinding of the coffee grinder in functionality test
523	Number of half-waves that reads the sensor (may vary)
2273	Average distance of the sensor impulse beds (may vary)
2000	Average of the last 4 millings in the normal mode as above (2273)



ERROR: The number remains 0 or the grinder does not run, or the display backlight changes from white to red; check the Grinder and the wiring from the Grinder to the CPU/POWER board (JP8)

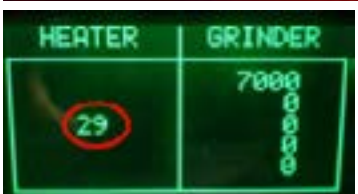

Check the temperature

The number shows the heater temperature.



ERROR: In the indication HEATER appears "SHORT", the NTC temperature-sensor is shorted, the display backlight changes from green to red; check the wiring from the NTC temperature-sensor to the CPU/POWER board (JP13).



ERROR: In the indication HEATER appears "OPEN", the NTC temperature-sensor is detached or broken, the display backlight changes from green to red; check the wiring from the NTC temperature-sensor to the CPU/POWER board (JP13).



Press the Z1 button to switch on the Heater

The absorbed current (Amperometer on the main supply) is OK, the indication **HEATER** changes from "OFF" to "ON" and the temperature starts increasing.



If temperature is over 100°C, the backlight change from GREEN to YELLOW. This is a ALERT message to avoid heating the HEATER element over dangerous temperature.

ERROR: the absorbed current is KO or the temperature does not increase; check the wiring from the heater to the CPU/POWER board (JP19) and the wiring of the NTC temperature-sensor (JP13).

5.1.1. SteamOut

This document describes the Steam-Out procedure; the application is used in order to empty the heater.

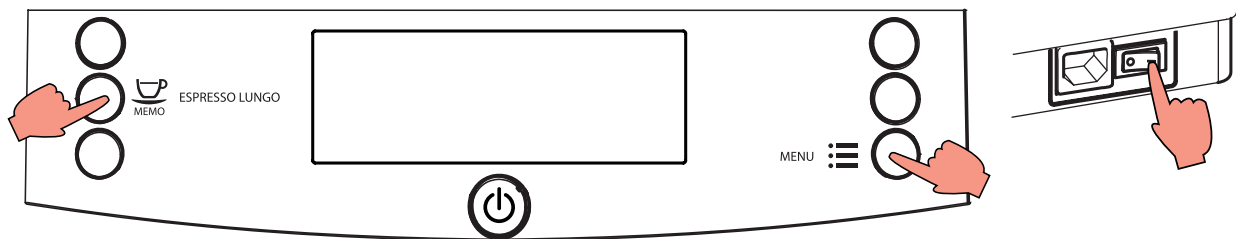

To enter in SteamOut

The machine enters in Steam-Out mode by holding pressed together: the "ESPRESSO LUNGO" button and the MENU button; while switching on the machine by main switch behind the machine.



Once entered the Steam Out mode the display shows the "STEAM OUT" indication. Buttons can be released



IMPORTANT NOTE: to execute the Steam-out procedure the Ntc sensor must work correctly; if some errors occurs on Ntc during the steam-out, the procedure can't continue and an error message is shown on the display.



IMPORTANT NOTE: to execute the Steam-Out procedure the DREGDRAWER must be in place and the DOOR must be closed. If these 2 conditions are not respected a warning message is shown on the display and the Steam-Out is interrupted



The machine starts the Steam Out and the display change the backlight (yellow) and appears the indication "ON". While the Steam Out runs the Electro valve is opened and water comes out the Water/Steam pipe.



When the Steam Out is complete the message "COMPLETE" is shown on the Display. The Electro valves automatically closes and the machine can be switched off.

When the Steam-Out is complete the following parameters are reset to their default values:

Length "Espresso" product	(Default 128 impulses)
Length "Espresso Lungo" product	(Default 292 impulses)
Length "Large Coffee" product	(Default 428 impulses)
Length "Cappuccino" (Coffee + Milk product)	(Default 170 impulses coffee & 34sec milk)
Length "Milk" product	(Default 34 seconds)
Stand-By Time	(Default 15 minutes)
Coffee Ground	(Default 0)
The request for Priming the Circuit at the first switch on is set.	
Brewing Unit Empty	
Aroma Strength Espresso	(Default 3 beans)
Aroma Strength Large Coffee	(Default 4 beans)
BU current array (BU during rinsing)	(Default 150mA)
Grinder Sensing Array	Default 2000ms)
Grinding time Aroma Very Light (1 Bean)	(Default 3000ms)
Grinding time Aroma Light/Medium (2/3 Beans)	(Default 3500ms)
Grinding time Aroma Strong/Extra Strong (4/5 Beans)	(Default 4000ms)
Filter Presence	(Default OFF)
Filter Pulses	(Default 0)
Last Error Log	(Default 0)
Coffee Duct Empty = TRUE (To grind more first time after steam-out and refill duct with coffee)	

5.2. Test Mode Philips 3000

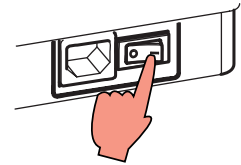

To enter Test Mode

The machine enters in test mode by holding together Espresso and Calc-Clean button while switching on the

machine by mean of the main switch on the backside of the CA.

Once entered shows Led Espresso, Led Coffee flashing in series (Level 0).

There are 6 different level, in each level the coffee-machine can execute different commands,

Level 0: Entry Level:

a) In this level can be done Reset to default

Level 1: The machine can test the interface (Leds & Buttons):

- a) Button "Espresso"
- b) Button "Coffee"
- c) Button "Calc-Clean"
- d) Button "Steam" & Led Steam under the button;
- e) Button "Hot-Water" & Led Hot-Water under the button;
- f) Button "Stand-By" & Led Stand-By under the button;
- g) No Water LED
- h) General Alarm LED
- i) Descale LED
- j) Rinsing LED
- k) Dreg drawer full LED
- l) No Beans LED

Level 2: The machine can test other input signal:

- a) Microswitch door closed/opened
- b) Microswitch present of the brewing unit
- c) Water Tank sensor

Level 3: The machine can test the loads in low voltage:

- a) Brew Unit movement upward and downward (24V DC)

Level 4: The machine can test the load:

- a) Pump (230V AC)
- b) DC Solenoid Valve @24V.
- c) Flow Meter

Level 5: The machine can test:

- a) Heater (100-120-230V AC)
- b) Grinder (140-170-320V DC)
- c) Grinder sensor

The user can switch the level by pressing the Button Stand-By, the machine shows the level of the test:

- a) Level 1 : Led Espresso ON (G), Led Stand-by ON (R)
- b) Level 2 : Led Espresso ON (G), Led Descale ON (O)
- c) Level 3 : Led Espresso ON (G), Led Descale ON (O), Led Calc-Clean ON (O)
- d) Level 4 : Led Espresso ON (G), Led Descale ON (O), Led Calc-Clean ON (O), Led Rinsing ON (O)
- e) Level 5 : Led Espresso ON (G), Led Descale ON (O), Led Calc-Clean ON (O), Led Rinsing ON (O), Led Coffee ON (G).

Legend:

(O) = Orange (G) = Green (R) = Red

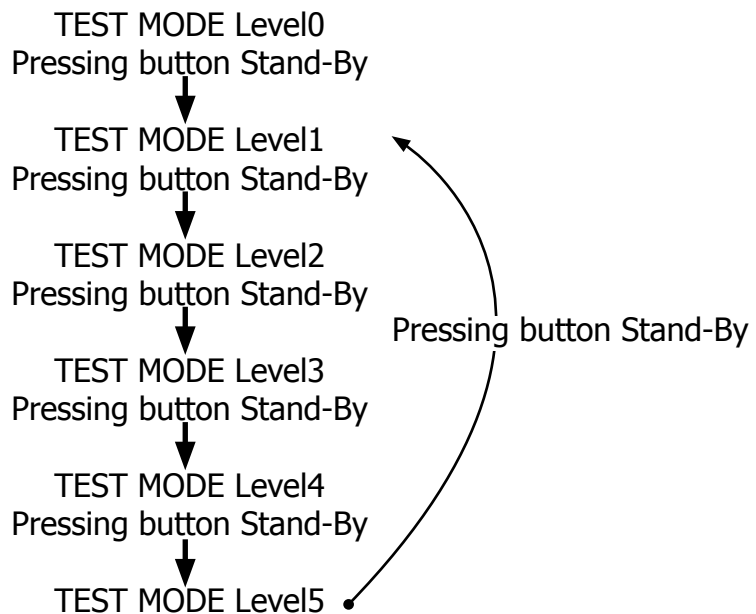

At the start up all loads are turned off. The software allow to have only one load active at the same time.

Level 0 (Start Test mode)

Start condition: NO BU, NO drag drawer, door open, No Water sensor	LED INDICATION	
	Led Espresso	Led Coffee
	Blink Alternately	

Press BUTTON Stand-By to move to the next screen

Level 1 (Key)

Start condition: NO BU, NO drag drawer, door open and No Water sensor	LED INDICATION					
	Led NoBeans	Led NoWater	Led GenAlarm	Led Dreg drawer full	Led Descale	Led Rinsing
	OFF	OFF	OFF	OFF	OFF	OFF

Press Espresso Button						
Action by user	LED INDICATION					
	Led NoBeans	Led NoWater	Led GenAlarm	Led Dreg drawer full	Led Descale	Led Rinsing
Switch on Red Leds NoWater & Dreg drawer full	OFF	ON	OFF	ON	OFF	OFF
ERROR: Led NoWater remains off, check the interface board and flat cable (JP21)		OFF		ON		
ERROR: Led Dreg drawer full remains off, check the interface board and flat cable (JP21)		ON		OFF		
ERROR: Led NoWater & Dreg drawer full remain off, check the interface board and flat cable (JP21)		OFF		OFF		

Press CalcClean Button						
Action by user	LED INDICATION					
	Led NoBeans	Led NoWater	Led GenAlarm	Led Dreg drawer full	Led Descale	Led Rinsing
Switch on Orange Leds Descale & Rinsing	OFF	OFF	OFF	OFF	ON	ON
ERROR: Led Descale remains off, check the interface board and flat cable (JP21)					OFF	ON
ERROR: Led Rinsing remains off, check the interface board and flat cable (JP21)					ON	OFF
ERROR: Led Descale & Rinsing remain off, check the interface board and flat cable (JP21)					OFF	OFF

Press Coffee Button						
Action by user	LED INDICATION					
	Led NoBeans	Led NoWater	Led GenAlarm	Led Dreg drawer full	Led Descale	Led Rinsing
Switch on Red Leds GenAlarm & NoBeans	ON	OFF	ON	OFF	OFF	OFF
ERROR: Led NoBeans remains off, check the interface board and flat cable (JP21)	OFF		ON			
ERROR: Led GenAlarm remains off, check the interface board and flat cable (JP21)	ON		OFF			
ERROR: Led NoBeans & GenAlarm remain off, check the interface board and flat cable (JP21)	OFF		OFF			

Press Steam Button		
Action by user	LED INDICATION	
	Led Steam Button	Led Hot-Water Button
Switch on green Led under the Steam Button	ON	OFF
ERROR: Led Steam remains off, check the interface board and flat cable (JP21)	OFF	OFF

Press Hot Water Button		
Action by user	LED INDICATION	
	Led Steam Button	Led Hot-Water Button
Switch on green Led under the Hot Water button	OFF	ON
ERROR: Led Hot-Water remains off, check the interface board and flat cable (JP21)	OFF	OFF

Finish condition: NO BU, NO drag drawer, door open and No Water sensor	LED INDICATION					
	Led NoBeans	Led NoWater	Led GenAlarm	Led Dreg drawer full	Led Descale	Led Rinsing
	OFF	OFF	OFF	OFF	OFF	OFF

Press BUTTON Stand-By to move to the next screen

Level 2 (Input)

Start condition: NO BU, NO drag drawer, door open and No Water sensor	LED INDICATION			
	Led NoBeans	Led NoWater	Led GenAlarm	Led Dreg drawer full
	OFF	ON	ON	ON

Insert a full Water Tank				
Action by user	LED INDICATION			
	Led NoBeans	Led NoWater	Led GenAlarm	Led Dreg drawer full
Switch off Red Leds NoWater	NA	OFF	NA	NA
ERROR: Led NoWater remains on, check the capacitive sensor (fixing) and the wiring (JP23)	NA	ON	NA	NA

Insert the Brew Unit				
Action by user	LED INDICATION			
	Led NoBeans	Led NoWater	Led GenAlarm	Led Dreg drawer full
Switch off Red Leds GenAlarm	NA	NA	OFF	NA
ERROR: Led GenAlarm remains on, check the BU presence Microswitch and the wiring (JP16).	NA	NA	ON	NA

Insert Dreg drawer and close the service door				
Action by user	LED INDICATION			
	Led NoBeans	Led NoWater	Led GenAlarm	Led Dreg drawer full
Switch off Red Led Dreg drawer full	NA	NA	NA	OFF
ERROR: Led Dreg drawer full remains on, check the Microswitch for the door and the wiring (JP14). NOTE: without the Dreg drawer correctly inserted the indication cannot change!	NA	NA	NA	ON

Finish condition: With BU, Drag Drawer, door closed and Tank	LED INDICATION			
	Led NoBeans	Led NoWater	Led GenAlarm	Led Dreg drawer full
	OFF	OFF	OFF	OFF

Press **BUTTON Stand-By** to move to the next screen

Level 3 (Brewing unit)

Start condition: NO BU, Drag drawer, door Closed and No Water sensor	LED INDICATION			
	Led NoBeans	Led NoWater	Led GenAlarm	Led Dreg drawer full
	OFF	OFF	OFF	OFF
If the Dreg drawer is not inserted or the Service door is not closed the BU test cannot be performed. If these 2 inputs are not in the right position, Led Dreg drawer full will be RED	NA	NA	NA	ON

Press the Espresso button to move BU to work				
Action by user	LED INDICATION			
	Led NoBeans	Led NoWater	Led GenAlarm	Led Dreg drawer full
	ON	NA	NA	NA
When the BU reaches the work position the Led NoBeans is switched on	NA	NA	NA	NA
ERROR: Led NoBeans remains off, Check the work microswitch (broken?), the BU motor (blocked?) and the wiring (JP16).	NA	NA	NA	NA
ERROR: led GenAlarm Switch ON; the absorbed current is much more 300mA (with BU) or 200mA (without BU) check the BU and the motor	NA	NA	ON	NA

Press the Coffee button to move BU to home				
Action by user	LED INDICATION			
	Led NoBeans	Led NoWater	Led GenAlarm	Led Dreg drawer full
	ON	NA	NA	NA
When the BU reaches the home position the Led NoBeans is switched on	NA	NA	NA	NA
ERROR: Led NoBeans remains off, Check the work microswitch (broken?), the BU motor (blocked?) and the wiring (JP16).	NA	NA	NA	NA
ERROR: led GenAlarm Switch ON; the absorbed current is much more 300mA (with BU) or 200mA (without BU) check the BU and the motor	NA	NA	ON	NA

Finish condition: With BU, Drag Drawer, door closed	LED INDICATION			
	Led NoBeans	Led NoWater	Led GenAlarm	Led Dreg drawer full
	OFF	OFF	OFF	OFF

Press **BUTTON Stand-By** to move to the next screen

Level 4 (Pump)

Start condition: BU not inserted, Drag drawer and service door closed, no water sensor	LED INDICATION			
	Led NoBeans	Led NoWater	Led GenAlarm	Led Dreg drawer full
	OFF	OFF	OFF	OFF
If the Dreg drawer is not inserted or the Service door is not closed the EV cannot be opened and test cannot be performed. If these 2 inputs are not in the right position, Led Dreg drawer full will be RED	NA	NA	NA	ON

Press the Espresso button to open the EV				
Action by user	LED INDICATION			
	Led NoBeans	Led NoWater	Led GenAlarm	Led Dreg drawer full
It is possible to hear the "click" from ElectroValve. The Led NoBeans is switched on	ON	NA	NA	NA

Press and release the Coffee button to switch on the Pump (100 impulses)				
Action by user	LED INDICATION			
	Led NoBeans	Led NoWater	Led GenAlarm	Led Dreg drawer full
The water goes out from the dispensing spout, the NoWater LED blink every Flowmeter pulse.	NA	BLINK	NA	NA
ERROR: the NoWater LED doesn't flashing and after 5sec this LED Switch ON; check: 1) The EV (open?) 2) Pump (is ON?), 3) The flowmeter (works rightly?) 4) the wiring from the flowmeter to the CPU/POWER board (JP5) 5) the wiring from the pump to the CPU/POWER board (JP24)	NA	ON	NA	NA

Finish condition: With BU, Drag Drawer, door closed	LED INDICATION			
	Led NoBeans	Led NoWater	Led GenAlarm	Led Dreg drawer full
	OFF	OFF	OFF	OFF

Press BUTTON Stand-By to move to the next screen

Level 5 (Grinder-Heater)

Start condition: NO BU, NO drag drawer, door open and No Water sensor	LED INDICATION			
	Led NoBeans	Led NoWater	Led GenAlarm	Led Dreg drawer full
	OFF	OFF	OFF	OFF

Check the Temperature				
Action by user	LED INDICATION			
	Led NoBeans	Led NoWater	Led GenAlarm	Led Dreg drawer full
The red led General Alarm remains OFF	NA	NA	OFF	NA
ERROR: The temperature sensor is shorted or opened, the led GenAlarm switch ON; check the wiring from the heater to the CPU/POWER board (JP13).	NA	NA	ON	ON

Press the Espresso button to switch on the Heater				
Action by user	LED INDICATION			
	Led NoBeans	Led NoWater	Led GenAlarm	Led Dreg drawer full
The user checks that the absorbed current is OK	NA	OFF	NA	NA
ERROR: the absorbed current is KO; check the wiring from the heater to the CPU/POWER board (JP17-3) and the other wiring	NA	OFF	NA	NA
ERROR: If temperature is over 100°C, the NoWater LED turn ON. This is a ALERT message to avoid heating the HEATER element over dangerous temperature; and Heater test cannot be performed.	NA	ON	NA	NA

Press the Coffee button to switch on the Grinder				
Action by user	LED INDICATION			
	Led NoBeans	Led NoWater	Led GenAlarm	Led Dreg drawer full
The grinder rotates and Led NoBeans Blink every grinder pulses.	BLINK	NA	OFF	NA
ERROR: the led NoBeans remains OFF and after the led NoBeans switch ON; check the hall sensor board in the Grinder, the wiring from the hall sensor board to the CPU/POWER board (JP2) and the wiring from the Grinder to the CPU/POWER board (JP8)	ON	NA	ON	NA

Finish condition: With BU, Drag Drawer, door closed	LED INDICATION			
	Led NoBeans	Led NoWater	Led GenAlarm	Led Dreg drawer full
	OFF	OFF	OFF	OFF

5.2.1. SteamOut

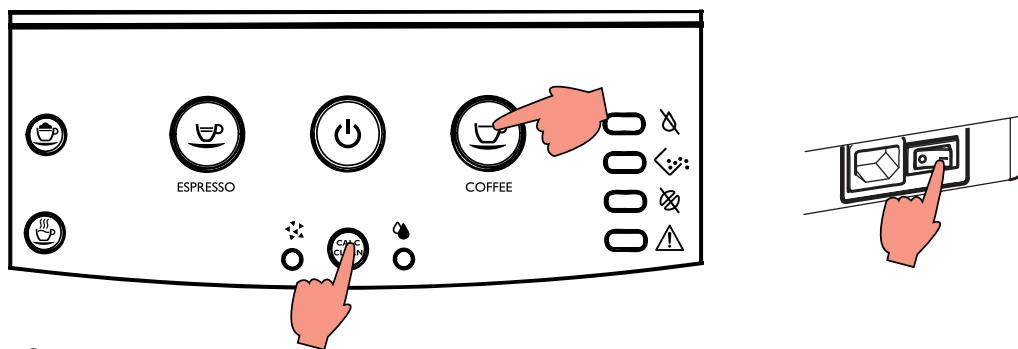

To enter in SteamOut

The machine enters SteamOut mode by holding pressed together the **COFFEE** button and the **CALC_CLEAN** button while switching on the machine.

Once entered the machine shows **Led Descale and Led Rinsing flashing in series.**

If there is a failure on NTC (Ntc disconnected or in short circuit) the operation cannot be performed and the **LED General Alarm will blink** (turn off the machine and repair before do Steam-out operation).

If Door is opened or drag drawer is removed **LED WASTE FULL will be switched on.** To start again the operation insert drag drawer and close service door.

At the end of procedure **LED ESPRESSO and LED COFFEE turns on.**

When the Steam-Out is complete the following parameters are reseted to their default values:

- Length Espresso product
- Length Coffee product
- Stand-By Time
- Count Coffee (Ground counter)
- The request for Priming the Circuit at the first switch on is set.
- Aroma
- Aroma Impulses
- Filter Presence
- Filter Pulses
- Dynamic threshold
- History of grindings for Beans Presence detection

5.3. Error codes

ERROR CODES	DESCRIPTION
01	The coffee grinder is blocked (grinder blades jammed or sensor not reading properly)
03	The brewing unit is blocked in work position (microswitch not released in up position after 3", torque error trying to move down, descent time out exceeded)
04	The brewing unit is blocked in home position (microswitch not released in down position after 3", torque error trying to move up, ascent time out exceeded)
05	Water circuit / flow meter problems (water circuit blocked or no flow meter signal)
10	Boiler temperature sensor short circuited
11	Boiler temperature sensor open circuit
14	The boiler temperature has exceeded the maximum allowed value (165°C)
15	The boiler temperature has not increased by x°C in y sec (boiler power supply disconnected, incorrect boiler fitted must be a 1300W boiler, partial power supply to boiler, cut out thermostat tripped)
19	Mains voltage trouble
22	interface missing or unknown

CHAPTER 6

STANDARD CHECKS

6.1. Repair Flow

Proces stap	Saeco no.	Action
Intake	1	Visual inspection (transport damage) take care for pictures
	2	Check Type/serialnumber
		Log all available accessory
Diagnosis	3	Check product for consumer complaint (NFF contact consumer)
	4	Opening machine
	5	Visual inspection check for loosen parts, leaking etc..
	6	Operational tests
Repair		Run Diagnostic to get error codes and relevant set statistics (Saeco Service Center SSC)
	7	Repairing the faults encountered
	8	"Checking any modifications (view Symptom Cure, new software, etc.) Refer Annex tabs per family"
	9	Service activities in accordance with the operating schedule
		Check/Replace Waterfilter (the small filter, not the Britta filter)
		Check/Replace Water tank lip seal
		Check/Replace Boiler pin O-ring
		Clean/align Coffee grinder (Vacuum cleaner / brush)
		Descale the water Circuit
		Check/Replace Hot water/steam valve
	10	Internal check / cleaning
		Check/Clean/Grease Brewing unit
	11	Operational test while the appliance is open
		Check Hoses, attachments and Oetiker clamps
	Check Pump for operation & noise	
	Check Gear motor for operation & noise	
	Check for leakage	
	12	Assembly
	13	Final inspection test
	14	Steam out before shipping out, if temperature is below 0° to prevent any damaged due to frozen water
Inspection		
visual		Do cabinet parts fit well together
		Check for damages
Power check		Will the set switch on
Accessoires		Do the accessories match with the intake
Consumer complaint		Check the product for the consumer complaint
Coffee		
Dispense		Make 2 * coffee. Are both amounts equal
		Make e 2 cups at the same time. Are the volumes equal

Noise		Is the sound normal
Crema		Blow on the coffee. Does the crema come back together
		Is the crema colour correct (Hazelnut)
Temperature		Is the coffee temperature within spec
Grinder		Is the grinder noise normal
Steam		
Steam		Does the steam work
Hot Water		Does the hot water work
Milk		(if applicable)
Cappuchino		Does the cappuccinatore produce good froth
Leakage		
Leakage	14	Did the product leak during the testing
	15	Draining the circuit (in winter)
Cleaning		Clean water reservoir, bean reservoir, brew chamber and conveyor
	16	Clean and dry brew unit, coffee bin and drip tray.
		Lubricating the brewing unit with suitable grease
		External cleaning
Safety check		
		Earth leakage, Isolation test, resistor of earth wire grounding, as requested in certain country's (VDE, ISO)
visueel		Check the mains cord for damages
Packing		
	18	Packing
		Check completeness (accessories) according income log
	19	Neatly pack the product
Documentation		NFF letter
		Descaling instruction with changed procedure (S/C)
		Other instructions according S/C
Repair report		Is there an answer to ALL consumer questions/complaints (see complaint)
		add set statistic and give, if needed clear instruction towards consumer
		Is it indicated which documents are added
		Are there tips how to prevent issues

CHAPTER 7

DISASSEMBLY

7.1. Outer Shell



Philips 3000

Remove the water tank, coffee container cover, drip tray, brew drawer, brewing unit.

Coffee dispenser 4000

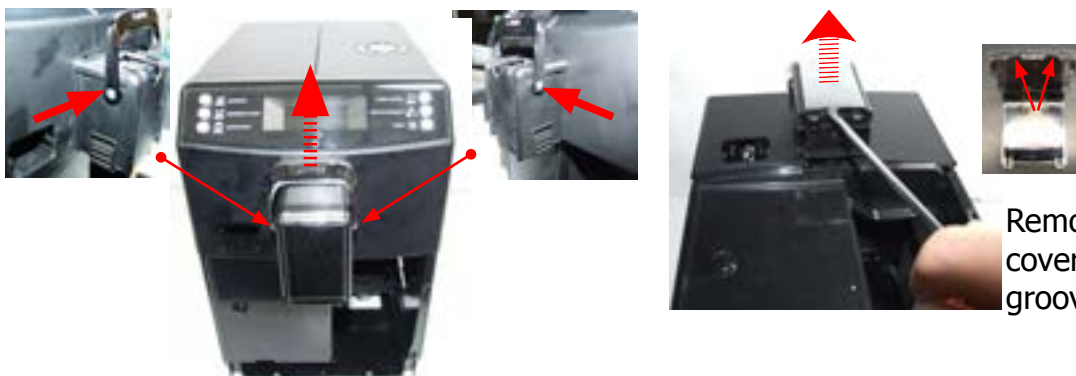

Remove the dispenser cover leveraging the grooves

Unscrew the screws shown and remove the lever

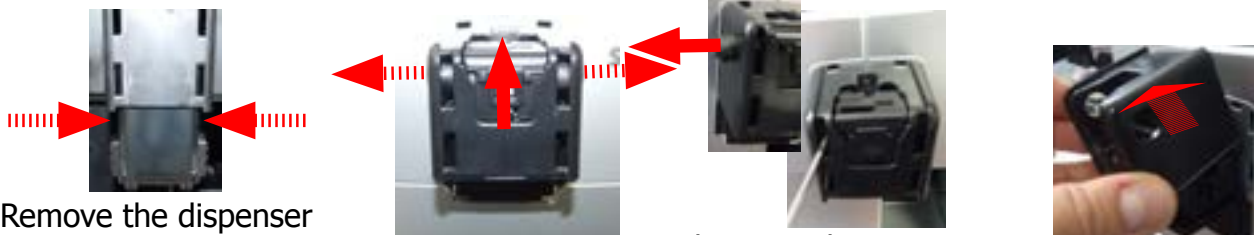

Remove the dispenser by pressing sideways

Unscrew the screw shown and remove the inserts with a screwdriver

Remove the cover

Unscrew the screw shown and remove the cover

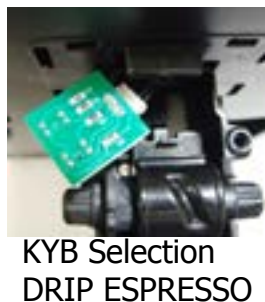

KYB Selection DRIP ESPRESSO



Unscrew the screw shown and remove the cover

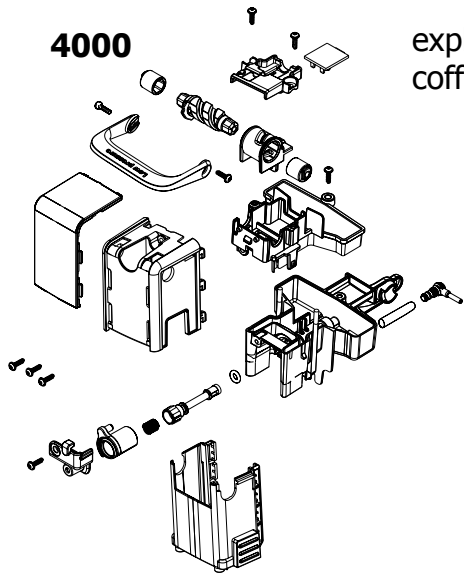

exploded view of the coffee dispenser

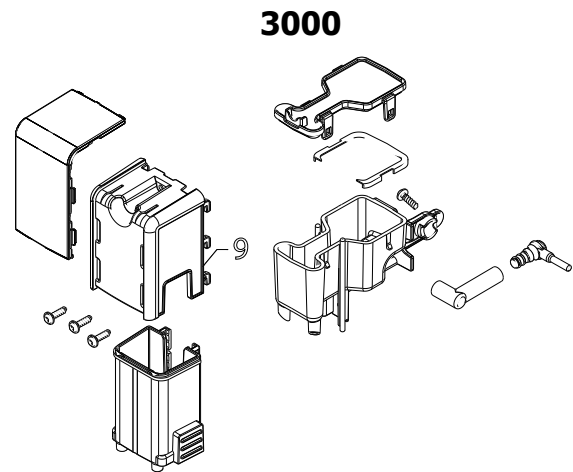

Upper cover



Unscrew the screws shown, raise the top cover and remove the electrical and water circuit connections.

7.2. Coffee grinder



Raise the coffee grinder and remove the connections.

When reassembling the coffee grinder, make sure the spring is repositioned correctly (see photo).

7.3. Grinder blades

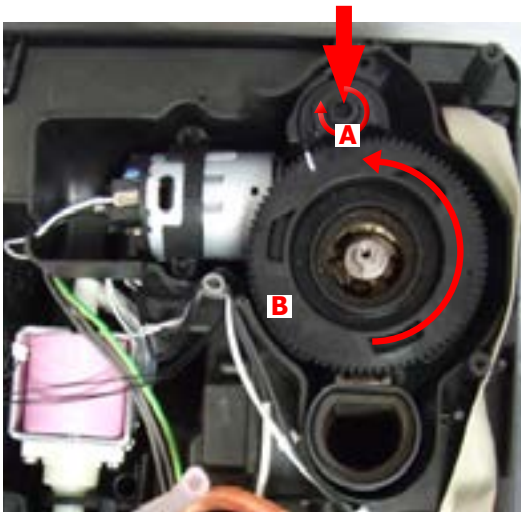

To extract the top support of the appliance, press on the grinding adjustment spindle (A) and turn the support anticlockwise until it unhooks.



Turn the grinder blades anticlockwise out of the support.

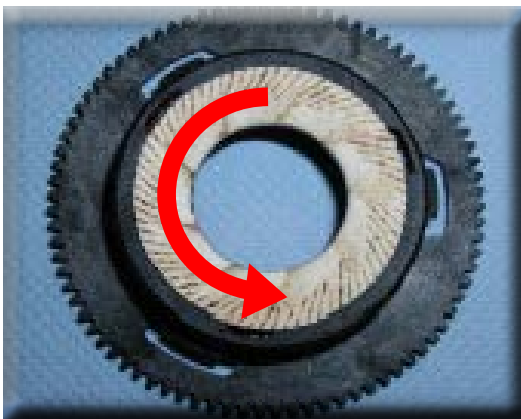

Turn the grinder blades clockwise out of the support. The bayonet connections can be accessed from the rear.

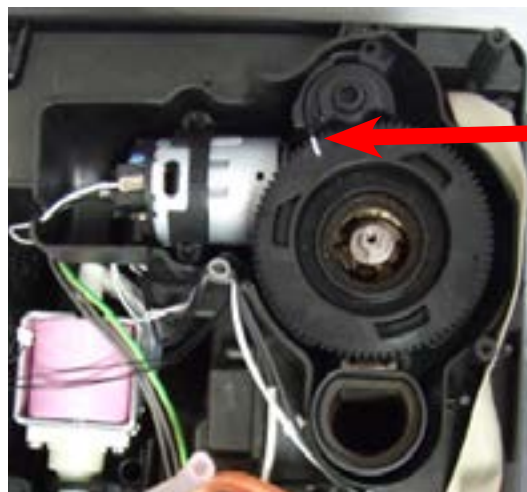

For a standard adjustment, both markings must be aligned.

7.4. Coffee grinder adjustment



The grinding adjustment can be set by the user (only with the coffee grinder in operation) by pressing and turning (only by one click at a time) the insert inside the coffee bean hopper with the aid of the wrench supplied.

Adjustment by a service center

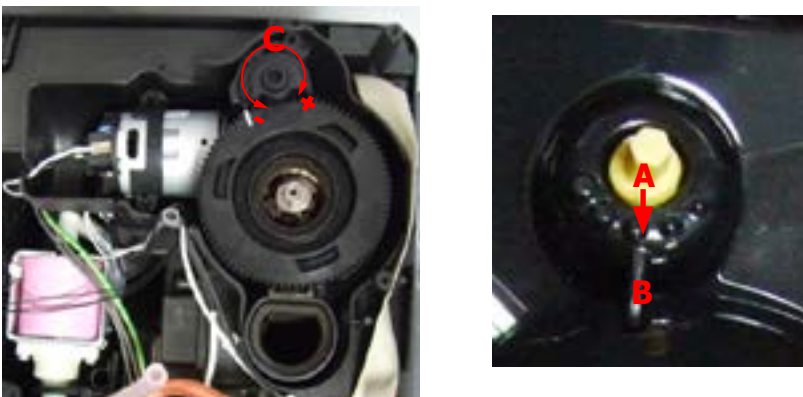

To adjust grinding further, the engineer can work directly on the coffee grinder by pressing and turning the ring nut (C) shown. (clockwise + to increase the particle size of the coffee and anticlockwise - to decrease it).

If there are any remains of coffee powder between the two grinding blades it is recommended to tighten by max. two marks at a time.

Lastly, move the arrow (A) on the adjustment knob to the center of the adjustment dots on the cover (B).

7.5. Carafe connection and hot/steam water dispenser



Slide out the fork as illustrated



Loosen the screws holding the carafe connection



When reassembling the assembly to be careful to correctly position the spring.

hot water dispenser



Removes the covers shown



unscrew the screws shown



7.6. Central plate

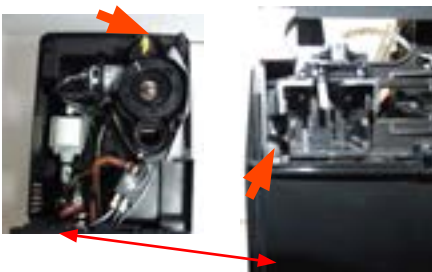

unscrew the screws shown



Lift up the center plate



7.7. Pin boiler

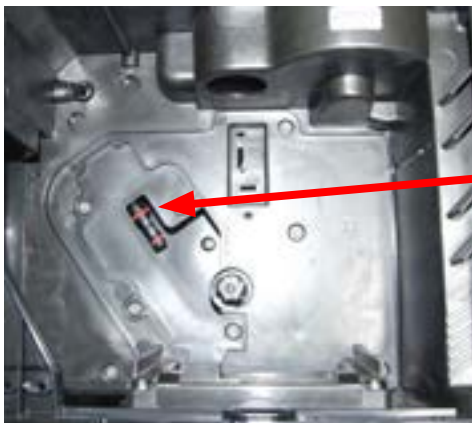

Loosen the screws as illustrated and remove the boiler pin (A).

7.8. Gear motor

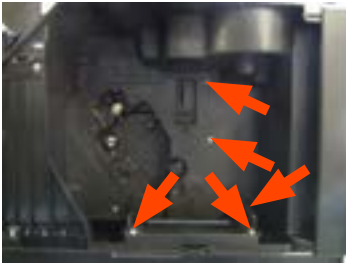

Loosen the screws as illustrated and remove the gear motor cover.

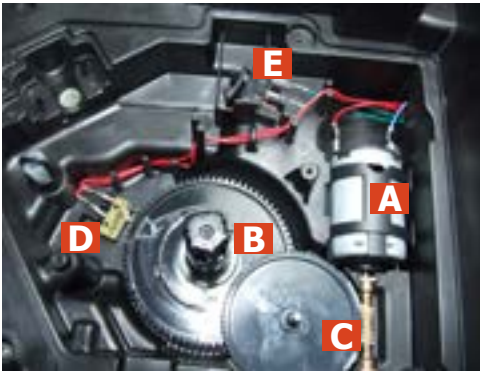

The following are located inside the compartment protected by the casing:

- Electric motor (A) with gears (B) and (C) for transmission and timing of the dispenser.
- Brewing unit present microswitch (E).
- Microswitch (D) detecting brewing unit home and work positions.
- Remove the gear (C) that meshes with the motor transmission shaft.
- Remove the large gear (B).
- Remove the motor (A), complete with transmission shaft.

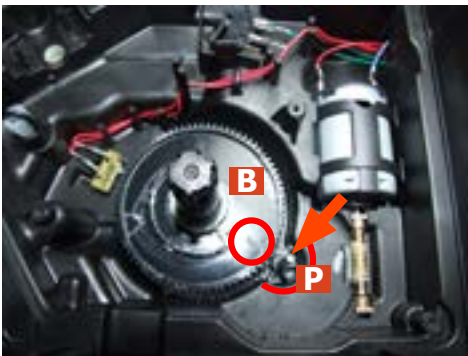

Replace the gear (B), making sure that the imprint of the arrow is aligned with the opening containing the pin (P).



When replacing the motor and the transmission shaft, make sure the guide runners (L) are in the right position.

Grease the shaft thoroughly and evenly.

7.9. Pump

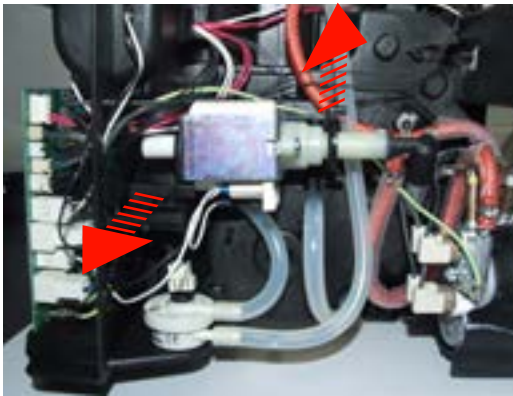

Unhook the pump from the supports.

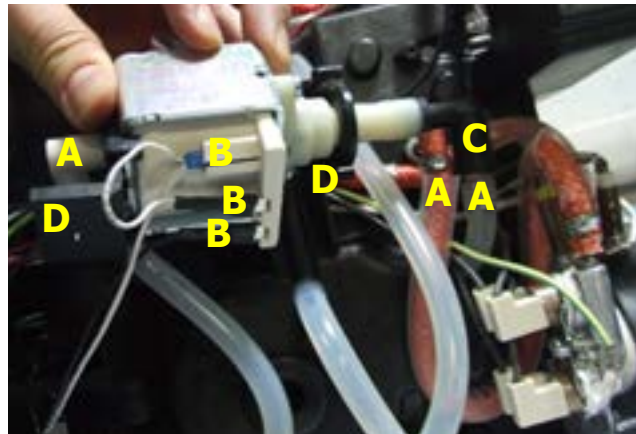

Disconnect the water circuit connections (A) and electrical connections (B), loosen the safety valve (C) and slide the pump off the brackets (D).

7.10. Flow-meter

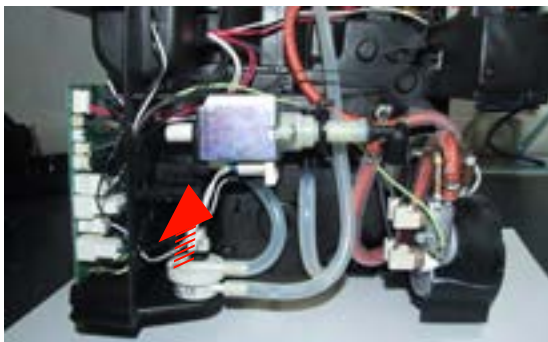

Lift the flow meter out of the casing assembly and remove the electrical and water circuit connections.

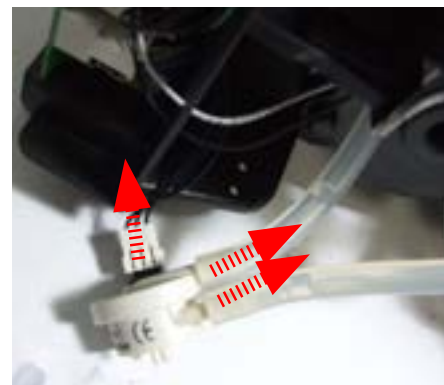

7.11. Boiler

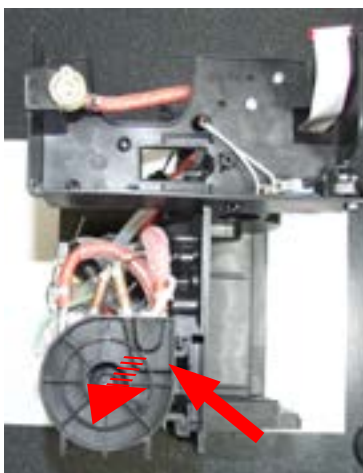

Unscrew the screw shown at unthread the support boiler



Unscrew the screw shown and remove the electrical and water circuit connections.

7.12. CPU board

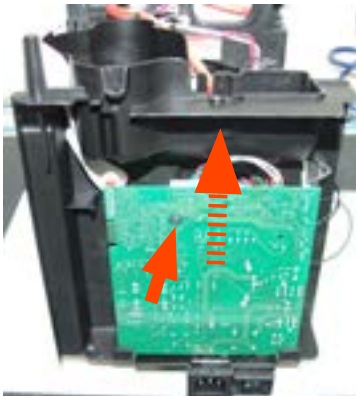

Loosen the screws slide the card off the support and disconnect the electrical connections.

7.13. Programming access for SSC (Saeco Service Center)

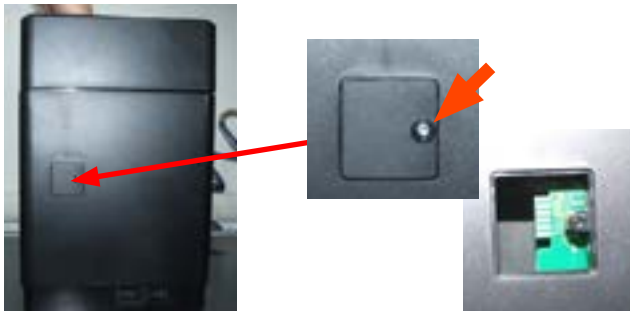

Loosen the screw for remove the cover.

7.14. KYB interface and display

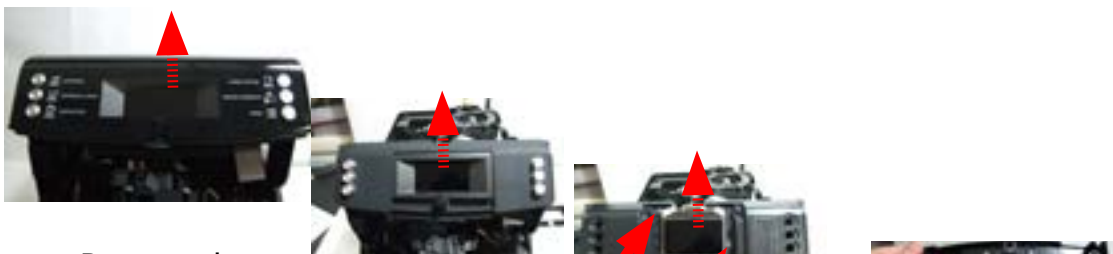

Remove the cover.

Loosen the screws for remove the cover.

Disconnect the electrical connections.



7.15. Fitting and removing Oetiker clamps

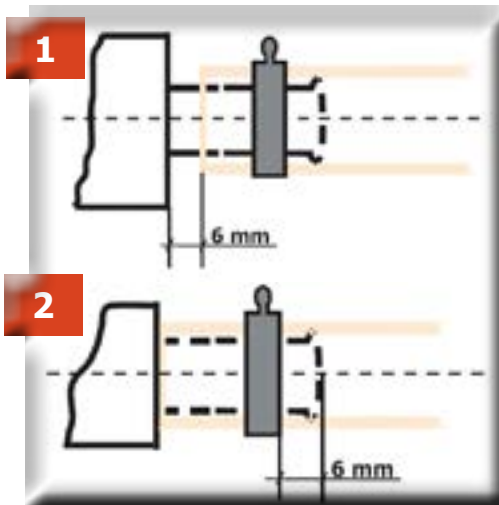

1) Boiler connection.

2) Other connections.



Use a suitable pair of pliers to remove the clamp (as illustrated).



Tighten the clamp as illustrated.

CHAPTER 8

NOTES

CHAPTER 9

WATER CIRCUIT DIAGRAM

Philips 4000/3000

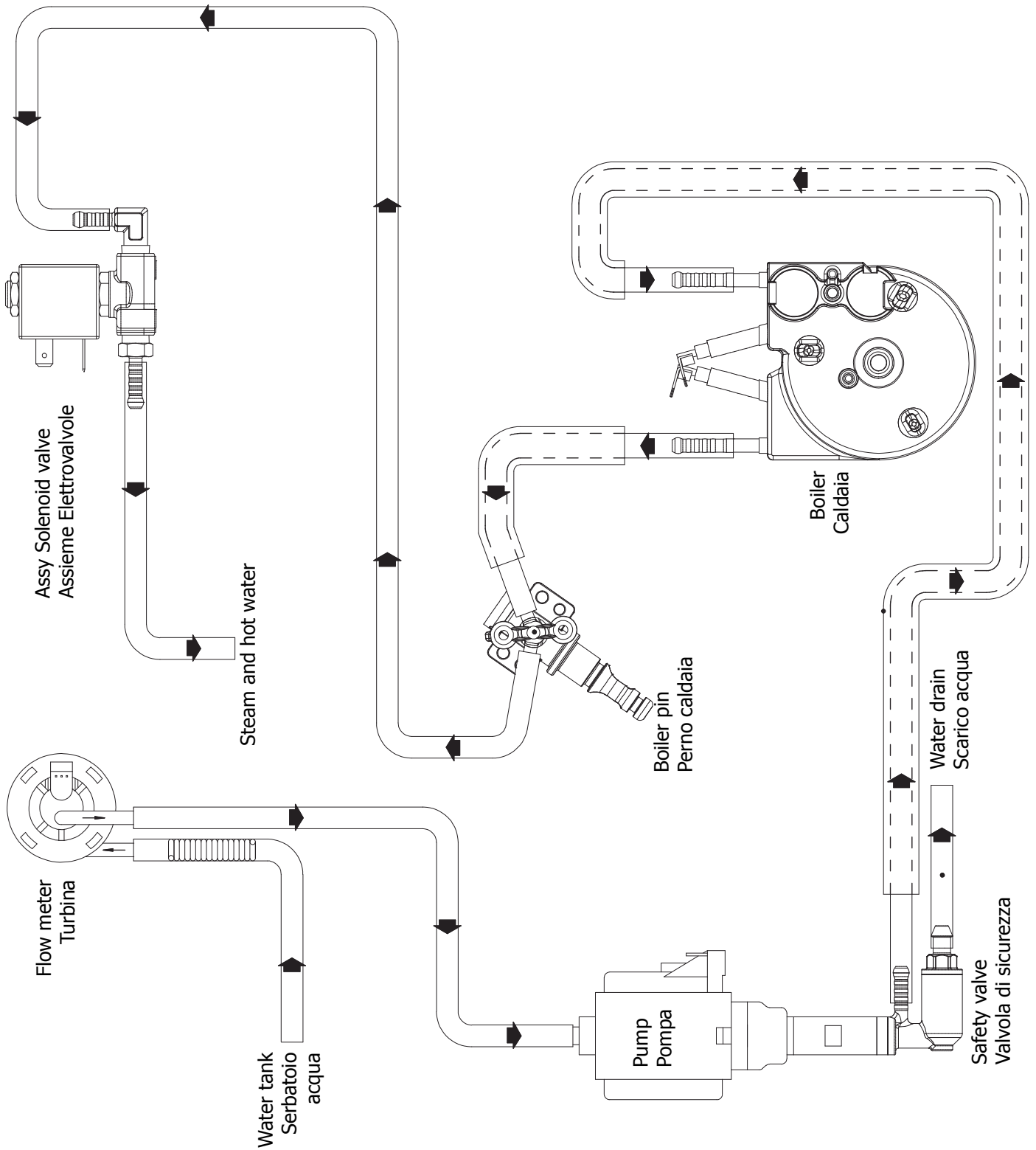

CHAPTER 10

ELECTRICAL DIAGRAM

Philips 4000

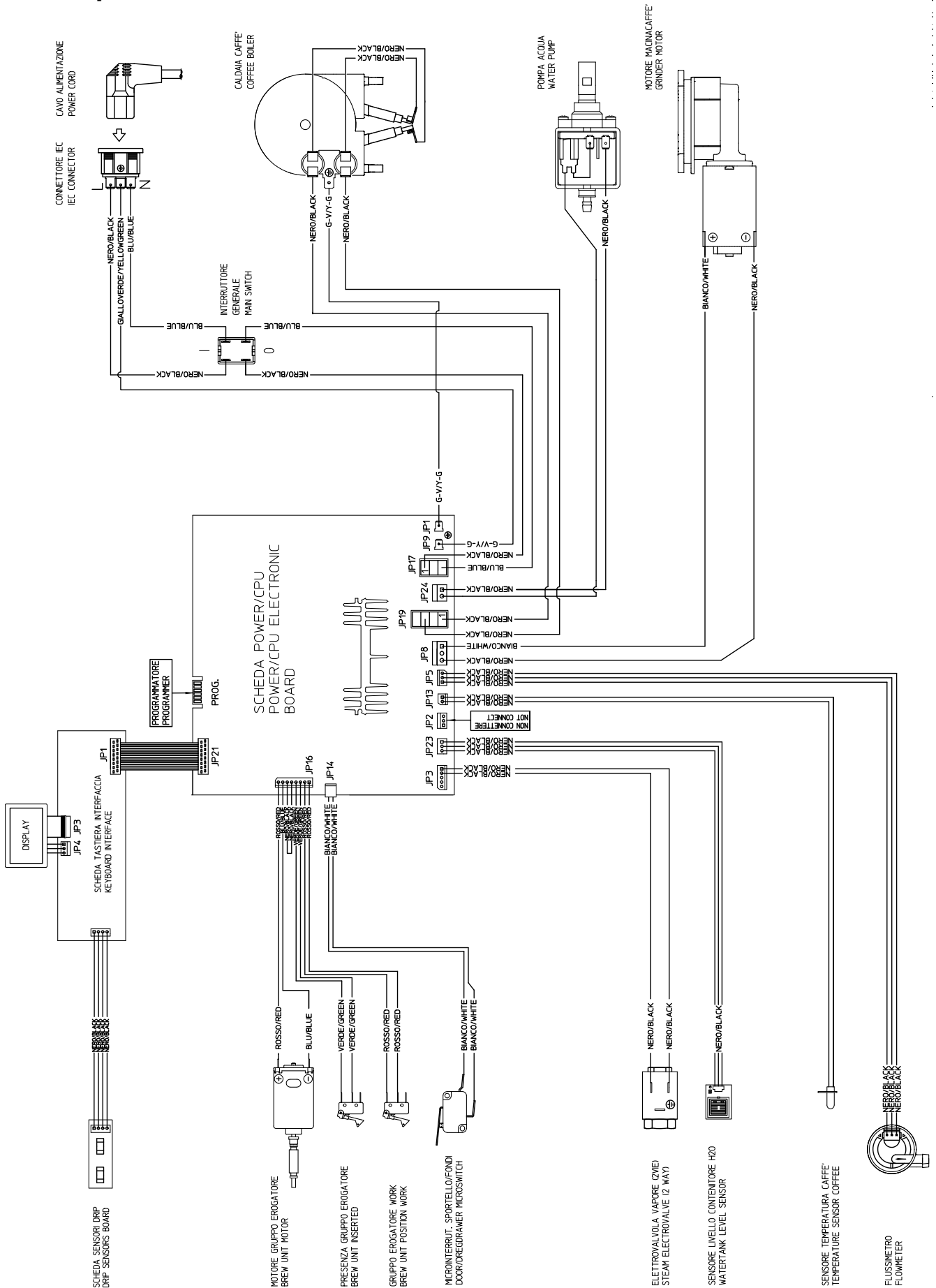

Philips 3000

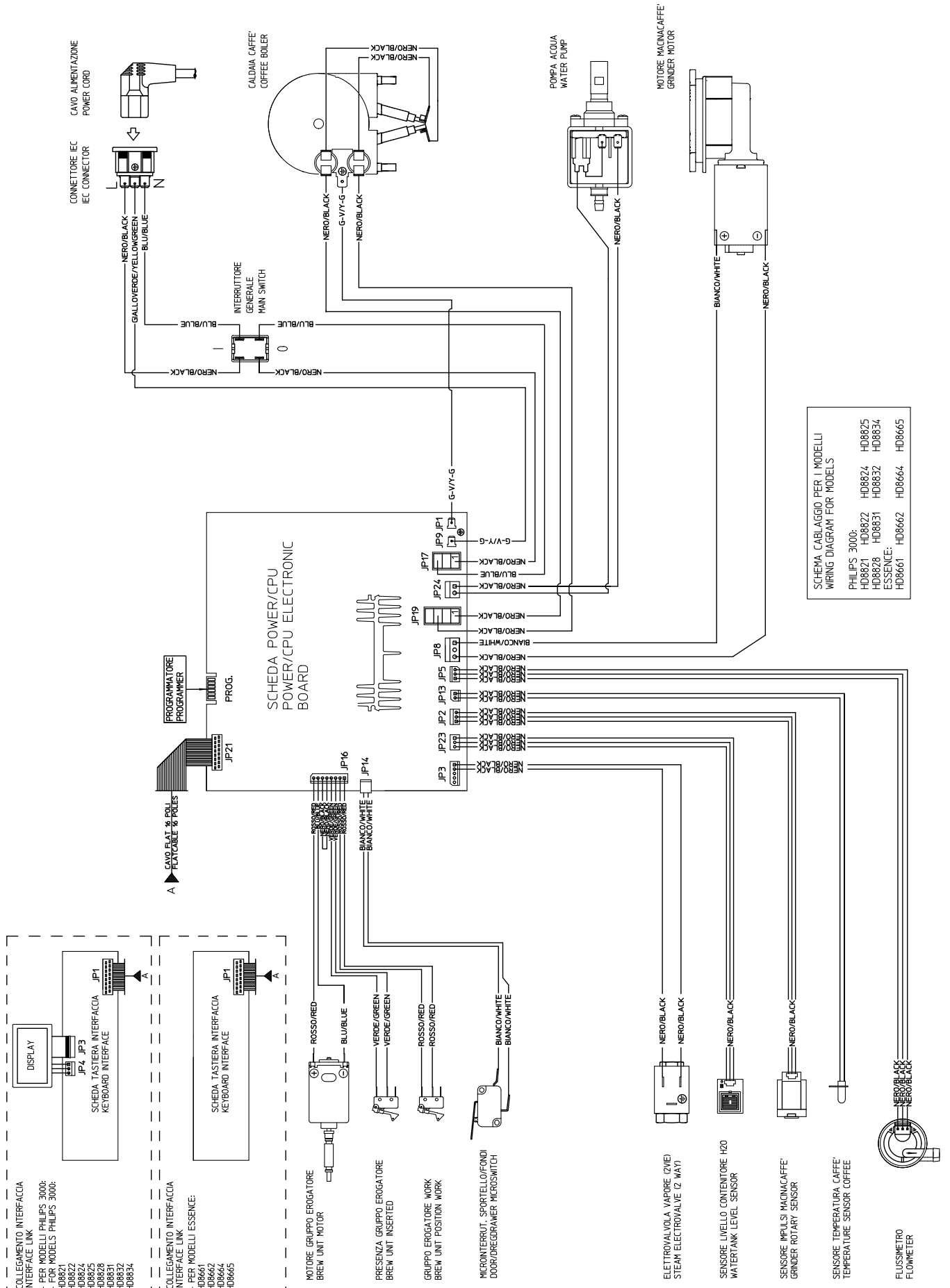

SCHEMA CABLAGGIO PER I MODELLI
WIRING DIAGRAM FOR MODELS

PHILIPS 3000:	HD8821	HD8824	HD8825
	HD8822	HD8823	HD8834
ESSENCE:	HD8651	HD8652	HD8665
	HD8661	HD8662	HD8664
		HD8666	HD8665

COLLEGAMENTO INTERFACCIA
INTERFACE LINK
- PER MODELLI PHILIPS 3000:
HD8821
HD8822
HD8824
HD8825
HD8831
HD8832
HD8834

COLLEGAMENTO INTERFACCIA
INTERFACE LINK
PER MODELLI ESSENCE:
HD8662
HD8664
HD8665

MOTORE GRUPPO ERGATORE
BREW UNIT MOTOR

PRESENZA GRUPPO ERGATORE
BREW UNIT INSERTED

GRUPPO ERGATORE WORK
BREW UNIT POSITION WORK

MICROINTERRUT. SPORTELLO/FONDI
DOOR/DREGRAMMER MICROSWITCH

ELETTROVALVOLA VAPORE (2VIE)
STEAM ELECTROVALVE (2-WAY)

SENSORE LIVELLO CONTENITORE H2O
WATERTANK LEVEL SENSOR

SENSORE IMPULSI MACINACAFFE
GRINDER ROTARY SENSOR

SENSORE TEMPERATURA CAFFÈ
TEMPERATURE SENSOR COFFEE

FLUSSIMETRO
FLOWMETER