

Service  
Service  
**Service**

Exprelia Series



# Service Manual

Rev.02 December 2012

Table of contents	Page	Table of contents	Page
1. Introduction		4.7. Coffee grinder	7
1.1. Documentation required	1	4.8. Low bean level detection, dose quantity adjustment, coffee grinder blocked	8
1.2. Tools and equipment required	1	4.9. Dose self-learning (SAS)	9
1.3. Material	1	4.10. SBS	10
1.4. Safety warnings	1	4.11. Water level detection (water tank)	11
1.5. Service Policy	2	4.12. Water level detection (drip tray)	11
1.6.1. External machine parts	3	4.13. Descaling request	12
1.6.2. Internal machine parts	4	4.14. Water filter	12
2. Technical specifications		5. Troubleshooting	
2.1. Technical specifications	1	5.1. Test mode	1
2.2. Specification for the measurement of the coffee products temperature	2	5.2. Diagnostics mode	5
2.3. Machine parameters and performance	3	5.3. Test mode Energica	7
3. User instructions		5.3. Error messages	11
3.1.1. Customer and programming menu	1	6. Standard checks	
3.1.2. Machine indications	3	6.1. Repair schedule	1
3.2. Customer and programming menu Energica	5	6.2. Service schedule	1
3.3. Operation, cleaning and maintenance	9	6.3. Final test	2
4. Operating logic		7. Disassembly	
4.1. Water circuit	1	7.1. Outer elements	1
4.2.1. Frother unit valve assembly	2	7.2. Coffee grinder	1
4.2.2. General carafe assembly	2	7.3. Grinder blades	2
4.3. Multi-way valve	4	7.4. Coffee grinder adjustment	3
4.4. Coffee cycle	5	7.5. Steam pump	4
4.5. Simple microswitch	6		
4.6. Temperature sensor	6		

All rights reserved. No part of this publication may be reproduced, stored in a retrieval system or transmitted, in any form or by any means, electronic, mechanical, photocopying, or otherwise without the prior permission of Saeco.

Table of contents	Page
7.6. Coffee pump	4
7.7. Turbine	4
7.8. Power card	4
7.9. Steam boiler	4
7.10. Coffee boiler	5
7.11. Gearmotor:	5
7.12. Multi-way valve	6
7.13. Frother unit valve assembly	6
7.14. Door tube coupling	6
7.15. Dispenser assembly	7
7.16. Steam pipe assembly	7
7.17. General carafe card assembly	8
7.18. Teflon pipe support and carafe attachment assembly	
7.19. CPU and display card	8
7.20. Fitting and removing Oetiker clamps	8
8. Notes	
9. Water circuit diagram	
10. Electrical diagram	



# CHAPTER 1

## INTRODUCTION

### 1.1 Documentation required

The following documentation is needed for repair procedures:

- Service manual for specific model
- Technical documentation for specific model (diagrams, exploded view, symptom cure and service manual)

### 1.2 Tools and equipment required

As well as the standard equipment, the following is required:

Qty.	Description	Notes
1	Screwdriver	Torx T 8 - T 10 - T 20
1	Pliers for Oetiker clamps	
1	CC -A - Vdc tester	
1	Digital thermometer	Scale limit > 150°C
1	SSC (Saeco Service Center)	Programmer (for programming and diagnostics mode)

### 1.3 Material

Description	Notes
Thermal paste	Heating element > 200°C
Descaler	Saeco descaler
Grease solvent	Personal choice
Silicone grease	Safe to use with food

### 1.4 Safety warnings

We recommend you consult this Service manual of the machine before performing any maintenance work.

Observe all applicable standards relating to the repair of electrical appliances.

Always disconnect the power plug from the mains before beginning repairs on the machine.  
**Simply turning off the main switch is not sufficiently safe to prevent electrical discharges.**

This household appliance is rated as insulation class I.

On completion of the repairs, insulation and dielectric rigidity tests must be performed.



## 1.5 Service POLICY grid as used for coffee machine

**For IN WARRANTY** repairs is mandatory to use the single components (not the assembly) available in the exploded views of the coffee machines or of the specific components. If you find the information "SEE THE EXPLODED VIEW E....." in the assembly description field, it means that the single components of the assembly are available in the other pages of the exploded view. It's possible to use the assembly only if there is a specific Symptom Cure that include this possibility or when the single components are not available for the order.

### List of principal assembly present in all our coffee machines

<b>Components</b>	<b>Assembly use</b>	<b>Single components available</b>
<b>COFFEE GRINDER</b>	<b><u>Only for OOW repairs</u></b>	<b>YES</b> , to consult the specific exploded-view of the machine or of the Coffee Grinder on website
<b>BREWING UNIT</b>	<b><u>Only for OOW repairs</u></b>	<b>YES</b> , to consult the specific exploded-view of the machine or of the Brewing unit on website
<b>BOILER</b>	<b><u>Only for OOW repairs</u></b>	<b>YES</b> , to consult the specific exploded-view of the machine on website
<b>GEAR MOTOR</b>	<b><u>Only for OOW repairs</u></b>	<b>YES</b> , to consult the specific exploded-view of the machine on website
<b>FILTER HOLDER</b>	<b><u>Only for OOW repairs</u></b>	<b>YES</b> , to consult the specific exploded-view of the machine on website
<b>MILK CARAFE</b>	<b><u>Only for OOW repairs</u></b>	<b>YES</b> , to consult the specific exploded-view of the machine on website
<b>THERMAL CARAFE</b>	<b><u>Only for OOW repairs</u></b>	<b>YES</b> , to consult the specific exploded-view of the Thermal Carafe on website
<b>MILK ISLAND</b>	<b><u>Only for OOW repairs</u></b>	<b>YES</b> , to consult the specific exploded-view of the Milk Island on website

**1.6.1 External machine parts**

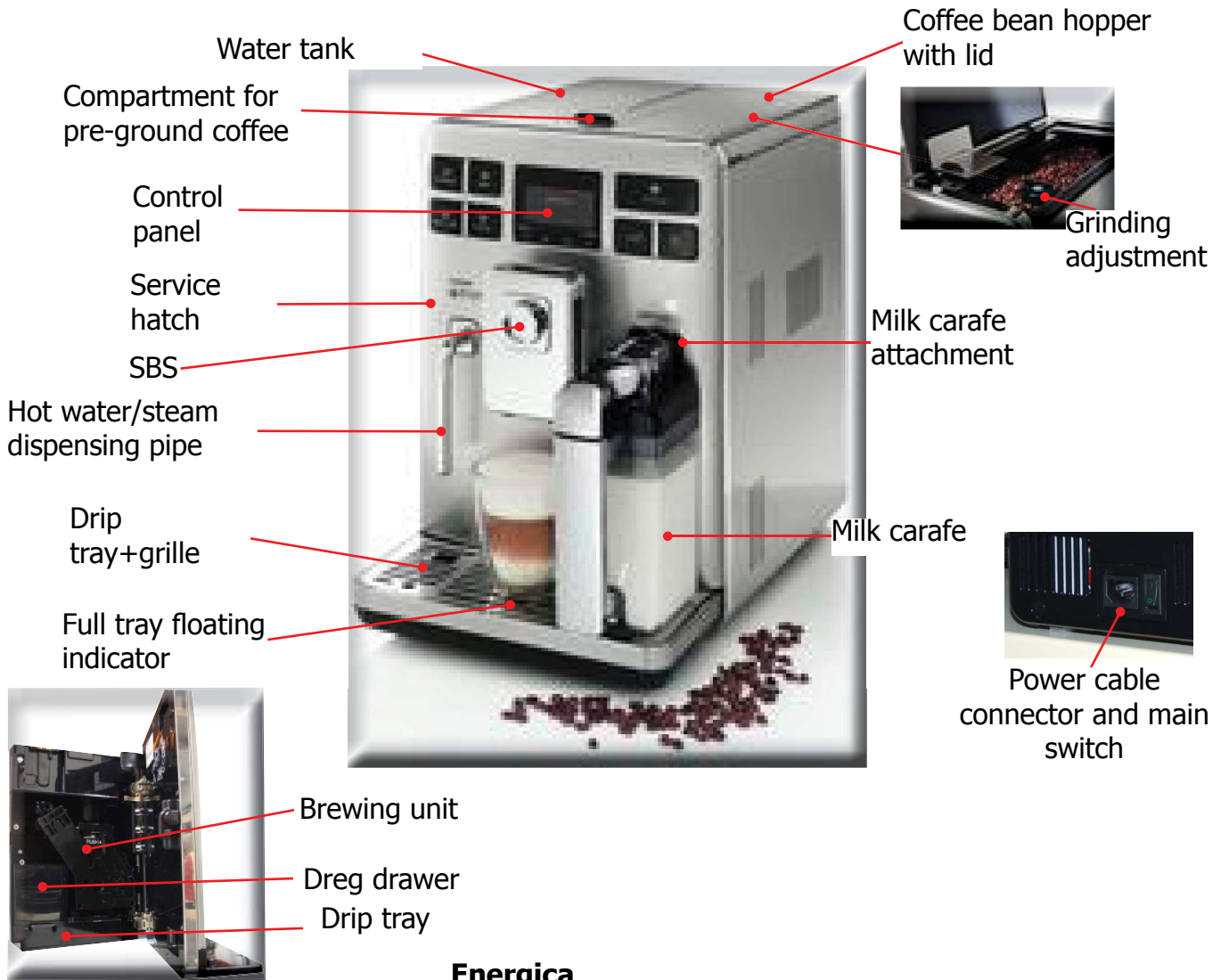

**Energica**

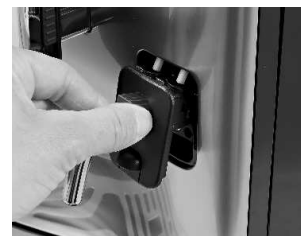

**WATER DISPENSING (removable)**

### 1.6.2 Internal machine parts

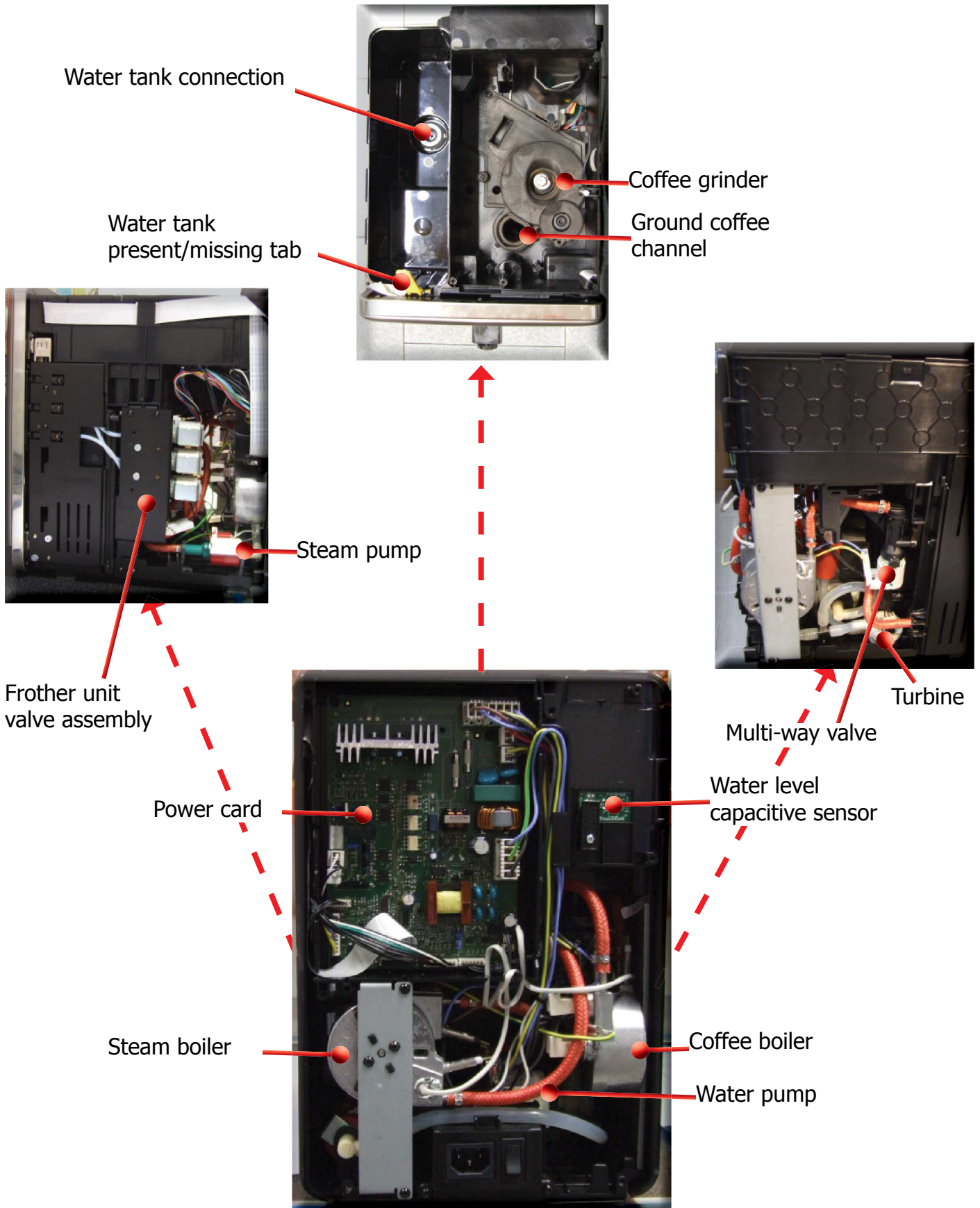



## CHAPTER 2

# TECHNICAL SPECIFICATIONS

## 2.1. Technical specifications

Power supply and output:	240 V~ 50 Hz 1400 W - 230 V~ 50/60 Hz 1400 W - 120 V~ 60 Hz 1500 W - 100 V~ 50/60 Hz 1300 W
Temperature monitoring:	Variable resistance sensors (NTC) transmits the value to the electronic card
Safety system:	2 manual reset or one-shot thermostats (175°C)
Coffee heat exchanger output: Stainless steel	(230/120 V~) 1300 W – (100 V~) 1100W for coffee, hot water and steam dispensing
Steam heat exchanger output: Stainless steel	As above
Gearmotor:	2 rotation directions; power supply 24VC
Coffee pump	Ulka Type EP5/S GW approx. 13-15 bar with reciprocating piston and thermal switch 120°C 48 W, 230V, 50 Hz, 120V, 60Hz 100V, 50/60 Hz
Steam pump	Ulka MF with reciprocating piston 230V, 50 Hz, 120V, 60Hz 100V, 50/60 Hz
Overpressure valve: (multi-way valve)	Opening at approx. 17-23 bar
Water filter:	In tank
Coffee grinder:	Direct current motor with flat ceramic grinder blades
Automatic dosage	Dose adjustment controlled by the electronic system
Power consumption:	During heating phase- approx. 5.6 A
Consumption in Standby	< 1 W
Dimensions: W x H x D in mm:	245x360x420
Weight:	14 kg
Water tank capacity:	1.5 l.
Coffee bean hopper capacity	300 g. of coffee beans
Dreg drawer capacity	11
Heat exchanger capacity:	Approx. 10 cc
Water circuit filling time:	Approx. 15 sec Max. on first filling cycle
Heating time:	Approx. 45 sec.
Grinding time:	Approx. 8-10 sec.

## 2.2. Specification for the measurement of the coffee products temperature.

The temperature is influenced by the flow from the dispenser and stratification of temperatures in the glass. In order to consider these phenomena and to introduce measures that allow comparisons in controlled conditions, below guidelines must be followed:

### Conditions:

- a) Water temperature in tank: 23°C (+/-2°C).
- b) It must be used a plastic cup (see picture N°1).
- c) It must be used a thermocouple thermometer (e.g. type K - see picture N°2).
- d) The coffee machine is tested without any change of parameters or calibrations, which may affect the temperature of products, so the measurement of temperature must be done with machine in default factory setting.

### Procedure:

1. The temperature must be measured in the cup, immediately after dispensing. Cup has to be placed on a non-metal surface using a thermocouple thermometer.
2. The temperature in the cup is measured by immersing the probe of the thermometer up to touch the bottom. The probe then must be moved in a circular motion for 5/6 rotations. At the of the rotations, stop in the center of the cup.
3. The highest temperature measured during the rotations is the value we are searching for, and that must be reported;
4. Test measurement: from end of dispensing to the end of rotations must be completed within 12 seconds.

### Limits of acceptability

The acceptance limits are divided by features and products and are the following:

#### Espresso Coffee Italy Q.ty 25/40 gr.

Temperature of 1st product 69°C ≤ 85°C

Temperature of 2nd product 72°C ≤ 85°C

#### Coffee Q.ty 70/120 gr.

Temperature of 1st product 69°C ≤ 85°C

Temperature of 2nd product 72°C ≤ 85°C





### 2.3. Machine parameters and performance

AMOUNT OF PRODUCT	Minimum amount (Puls.)	Default amount (Puls.)	Maximum amount (Puls.)	User programmable	Programm. by Production / Service
<b>Espresso</b>	50	130 - 170 *	600	Yes	No
<b>Long coffee</b>	70	200 - 230 *	600	Yes	No
<b>Pre-ground</b>	Yes				
<b>Hot water</b>	Continues for 400 pulses				
<b>Steam for frother</b>	Continues until the water supply has been exhausted (capacitive sensor)				

\* Depends on the language selected by the user

RINSE	Initial rinse	Final rinse
When performed	When the machine is switched on and the boiler temperature is $\leq 50^{\circ}\text{C}$	When the machine is switched off electronically, manually or automatically after 60', if at least one coffee has been dispensed, before switching off
No. of pulses	130	100
Stopping option	Yes, by pressing any key	Yes, by pressing any key
User disable option	Yes	No
Disabling by Production/Service department	No	No
No. of pulses user adjustment option	No	No
No. of pulses adjustable by Production/Service department	No	No
Pulse range (Min. – Max.)	No	No

Descaling cycle frequency			
Hardness	Water hardness	Without water filter	With water filter
<b>1</b>	Soft (up to 7°dH)	240 litres (480,000 pulses)	480 litres (960,000 pulses)
<b>2</b>	Medium (7° - 14°dH)	120 litres (240,000 pulses)	240 litres (480,000 pulses)
<b>3</b>	Hard (15° - 21°dH)	60 litres (120,000 pulses)	120 litres (240,000 pulses)
<b>4</b>	Very hard (over 21°dH)	30 litres (60,000 pulses)	60 litres (120,000 pulses)

The default water hardness level is 3. Each litre of water corresponds to approximately 2,000 pulses

EXPRELIA	02 TECHNICAL SPECIFICATIONS
DREG DRAWER	Description and values
Time-out for dreg drawer	5 sec.
Warning to empty dreg drawer after	Yes, after 12 lots of dregs
Shutdown alarm to empty dreg drawer after (double coffee as last product dispensed)	15 lots of dregs (16 lots of dregs)
Reset dreg counter	The dreg drawer must be emptied only when prompted by the machine ensuring the machine is switched on and removing the drawer for more than 5 seconds.

STANDBY	Description and values
Inlet time (min. – max.)	15 minutes - 180 minutes
Inlet time (default)	60 minutes
Inlet time programmed by user	Yes
Inlet time programmed by Production/Service	Yes
Boiler temperature during Standby	Boiler OFF
Cup heater during Standby	Cup heater OFF
Timer and Standby	Yes **

**\*\* The machine switches on at the TimerOn (Timer) value and switches off when the "Standby time" (Delay – Time) has elapsed**

WATER TANK	Description
Water reserve (pulses) with water filter	200
Water reserve (pulses) with no water filter	200
Water reserve modifiable by Production/Service departments	No
"Fill tank" alarm	Yes
"No tray" alarm	No
Water mains	No





# CHAPTER 3

# USER INSTRUCTIONS

### 3.1.1. Customer and programming menu

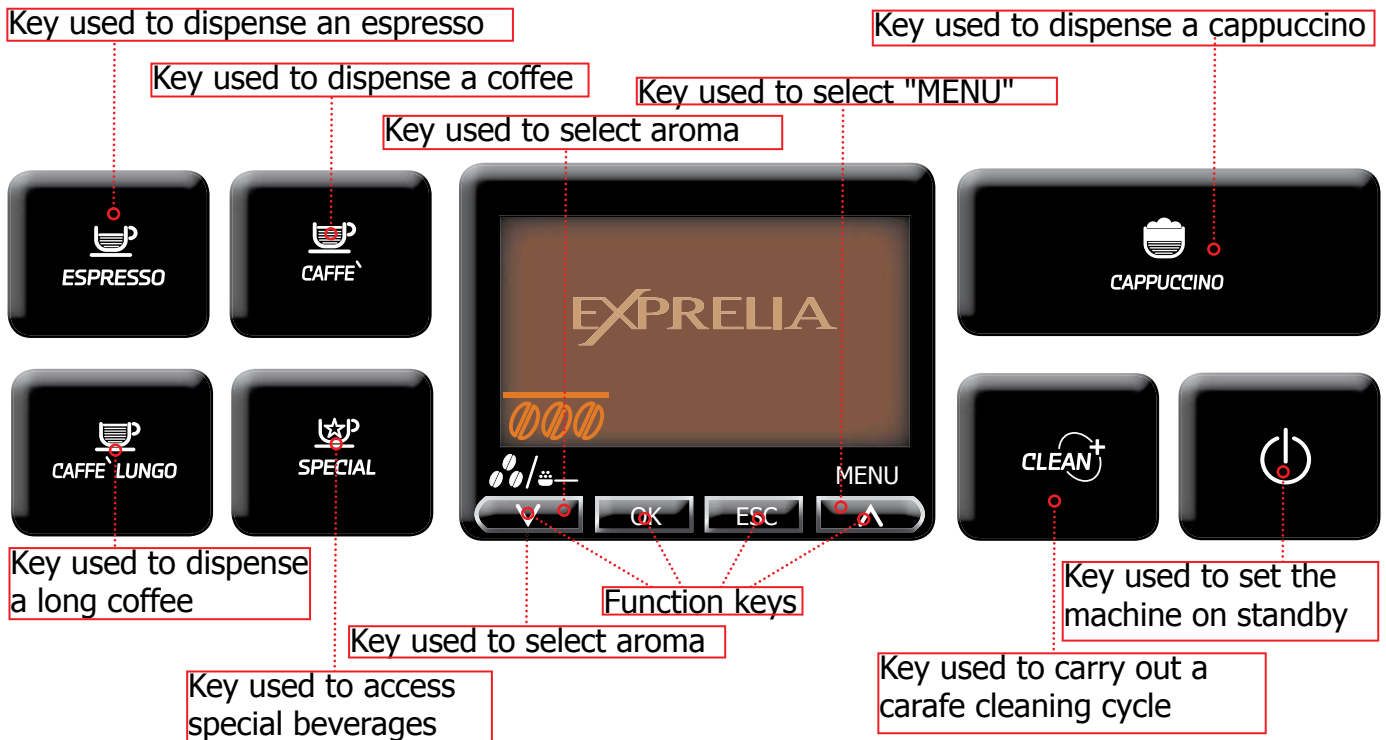

**BEVERAGE MENU** The machine allows custom settings for dispensing each beverage



Press the "MENU" button to go to the machine's main menu



Press the "OK" button to go to the BEVERAGE MENU



1. Scroll/select key
2. Select/confirm key
3. Exit key
4. Scroll/select key



- **Quantity of Coffee:** this section enables programming the quantity of coffee to be ground for making the beverage; this setting will affect the aroma of the coffee. GROUND - LIGHT - MEDIUM - STRONG
- **Pre-brewing:** the coffee is slightly moistened before brewing to enhance the aroma of the coffee. OFF - LOW - HIGH
- **Coffee temperature:** LOW - NORMAL - HIGH
- **Coffee size:** Used to program the quantity of coffee to dispense.
- **Amount of milk:** (only for cappuccino, latte macchiato and hot milk) Used to program the quantity of milk to dispense.
- **Amount of water:** (only for HOT WATER) Used to program the quantity of water to dispense.
- **Default:** The standard values set as default by the manufacturer are reprogrammed.
- **SPECIAL BEVERAGES:** This function includes LATTE MACCHIATO, HOT MILK and HOT WATER

**MACHINE MENU** Used to customize the machine's operational settings



Press the "OK" button to go to the MACHINE MENU



Press the "OK" button to go to the submenus

**GENERAL MENU**

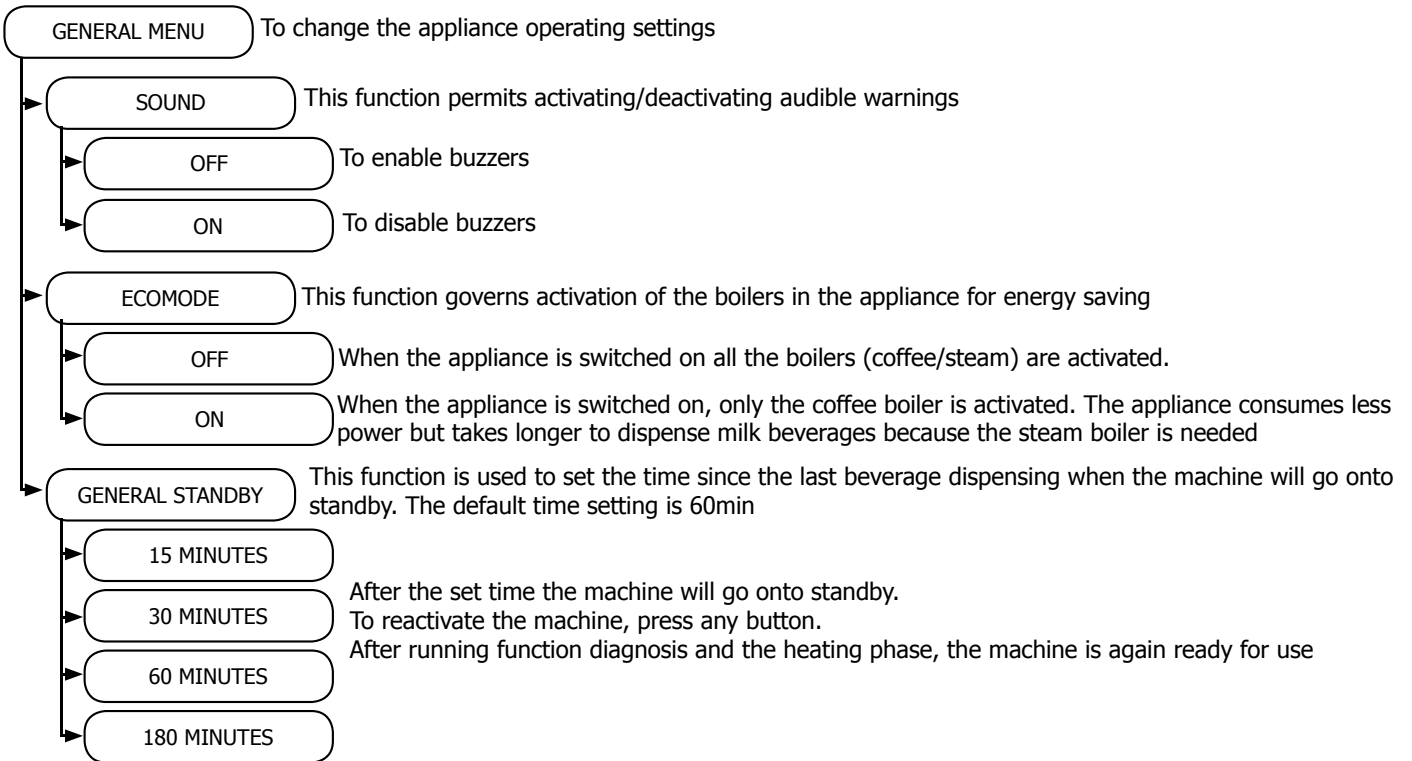

**DISPLAY MENU**

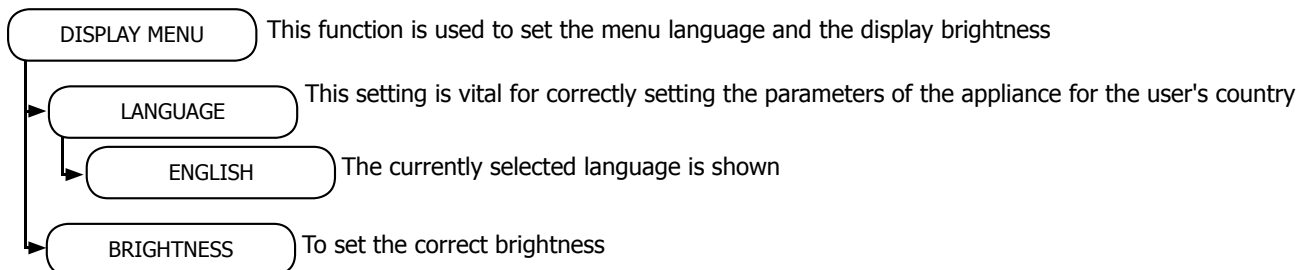

**WATER MENU**

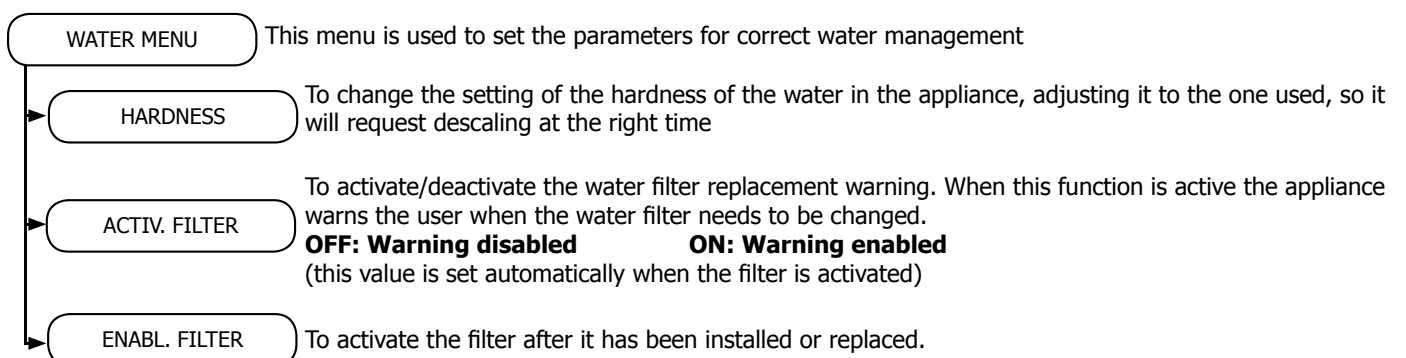

**MAINTENANCE**

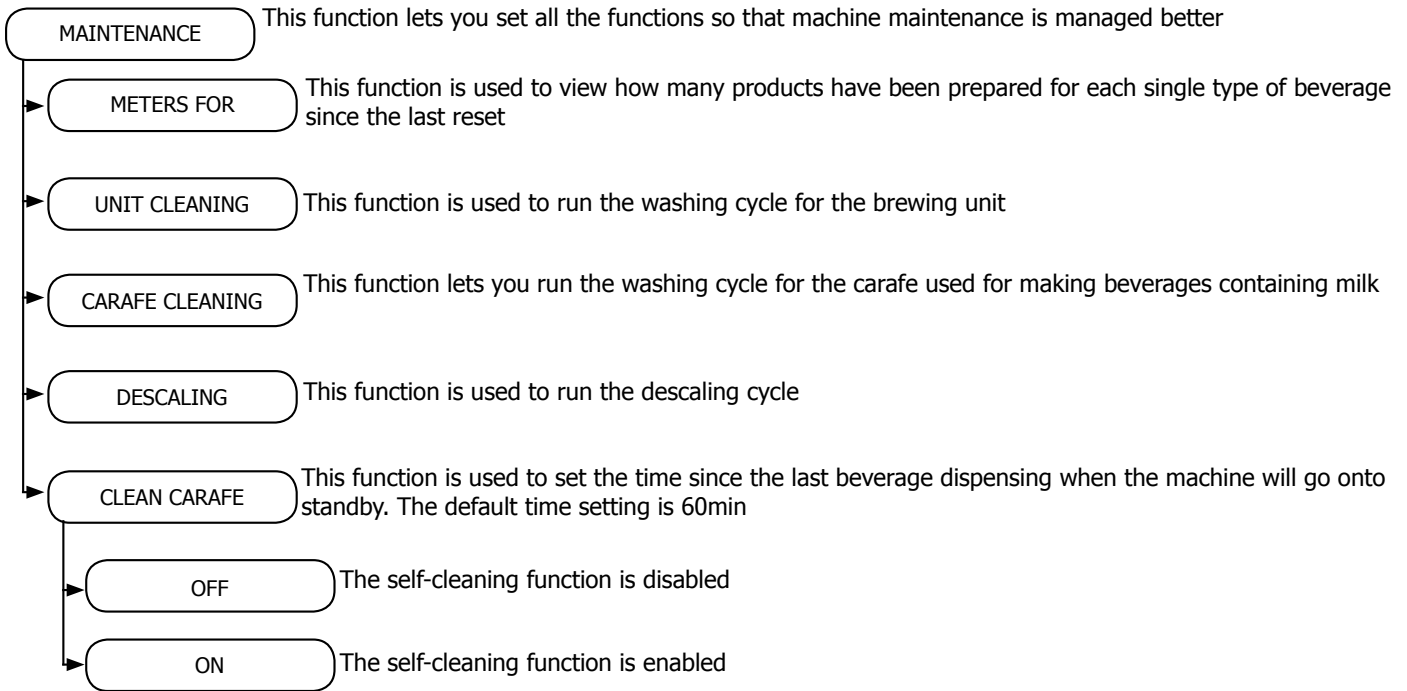

**FACTORY SETTINGS**

**FACTORY SETTINGS** This function allows the factory values to be reset. Restoring the factory parameters deletes all the personal parameters set beforehand.

**3.1.2. Machine indications**



Close the coffee bean hopper lid to enable delivery of any beverage

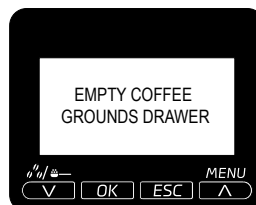

Remove the dregs drawer. Note: The dregs drawer must only be emptied when requested by the machine and with the machine on.

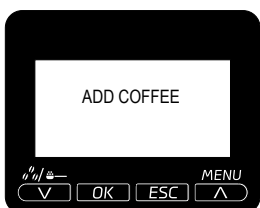

Fill the coffee container

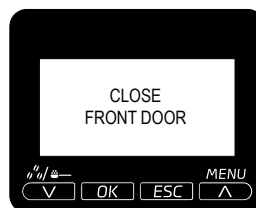

For the machine to become operative, the service hatch must be closed



Insert the brewing unit in its correct location

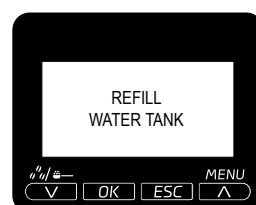

Take out the tank and fill it with fresh drinking water



Insert the dregs drawer



Open the front hatch and empty the drip tray underneath the brewing unit. You should also empty the dreg drawer, as the dregs counter will also be reset when the machine is switched on.



A beverage containing milk has been selected. The machine asks you to place the carafe handle spout in its dispensing position. Press "ESC" to cancel the procedure

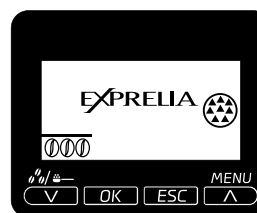

The appliance requires a descaling cycle. With this message you can keep on using the machine but there is the risk it will not work properly.

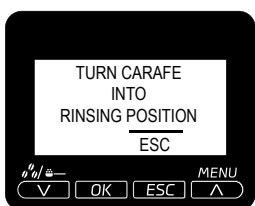

The carafe rinse function has been selected. Press "ESC" to cancel the procedure

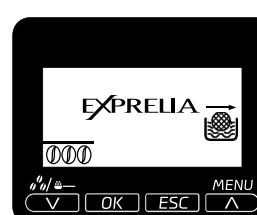

The machine requires replacement of the "Intenza" filter with a new one. The alarm is displayed only if the "enable filter" function is ON.

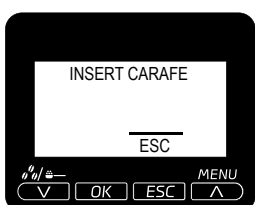

An operation has been selected that requires dispensing from the milk container. Insert the milk container. Press "ESC" to cancel the procedure

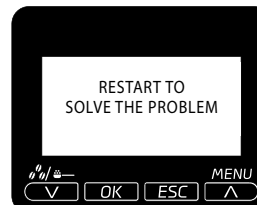

An even has occurred that requires restarting the appliance. Take note of the code (E xx) shown at the bottom



Red LED blinking Machine on Standby. It is possible to change the Standby settings Press the button to exit Standby

### 3.2. Customer and programming menu Energica

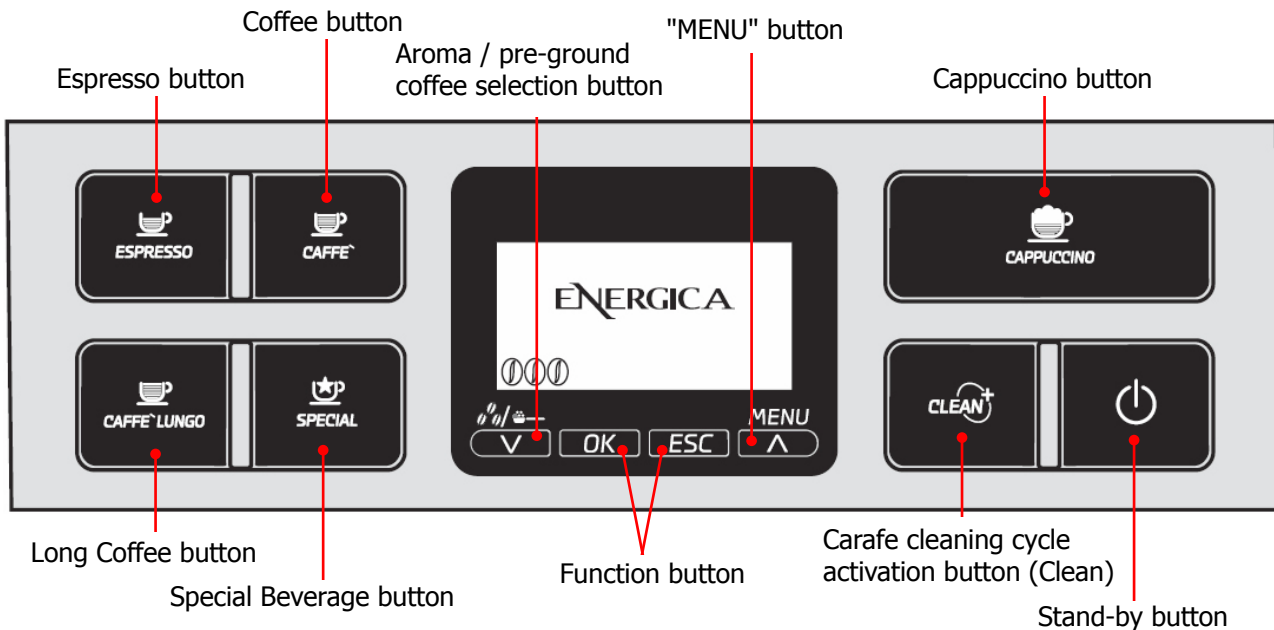

#### GENERAL MENU

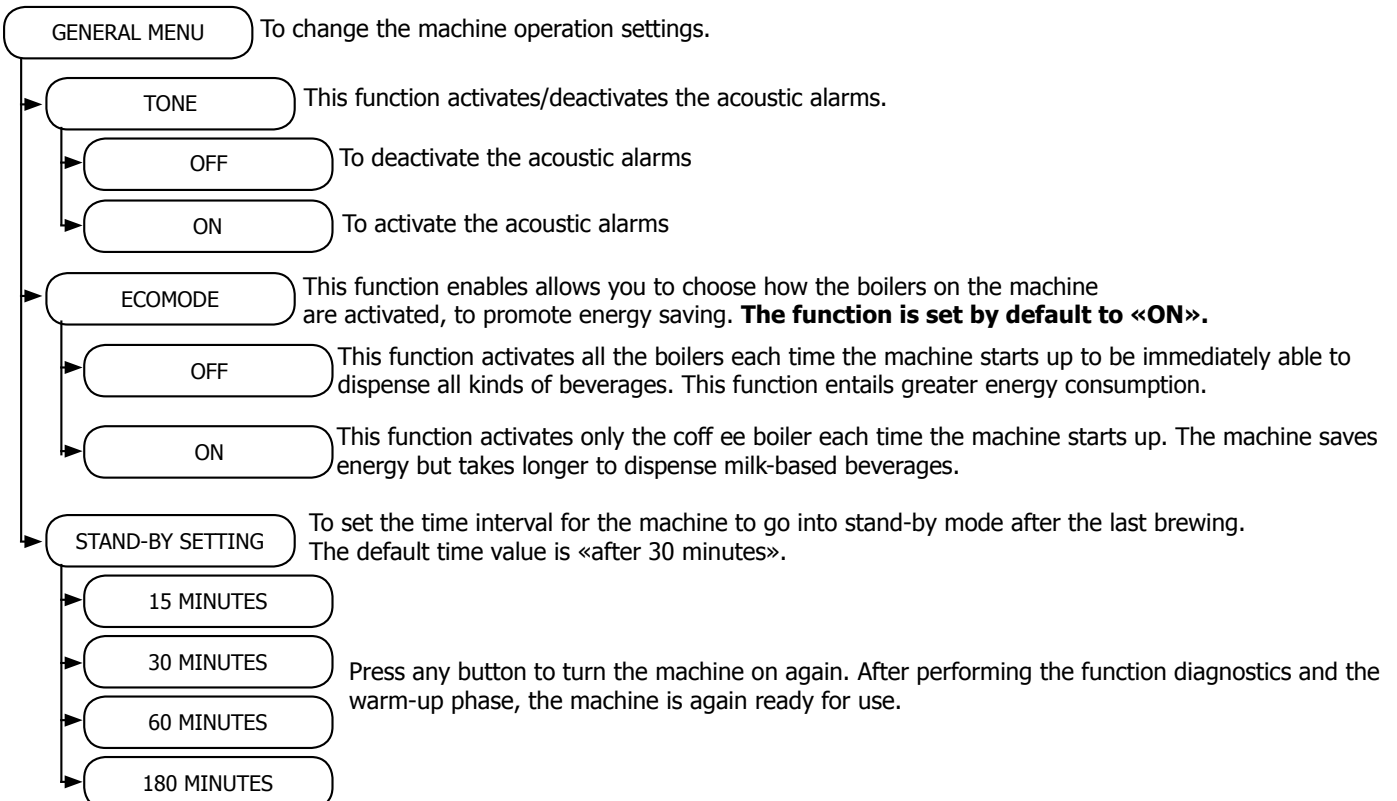

## DISPLAY MENU

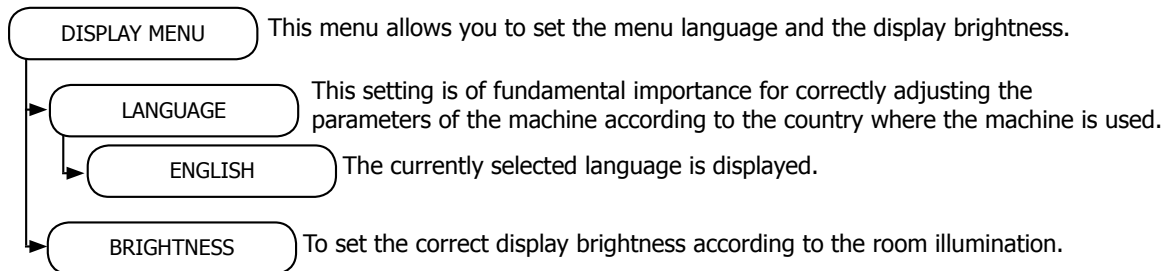

## WATER MENU

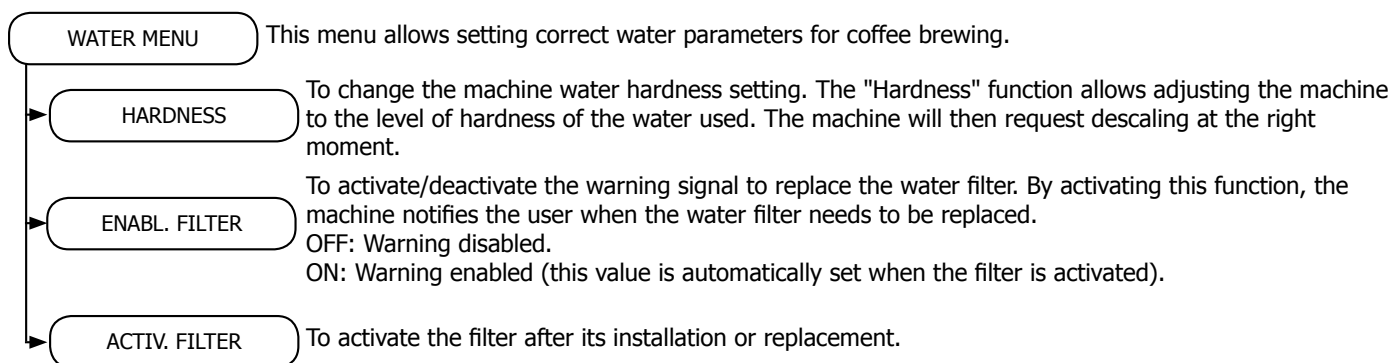

## MAINTENANCE

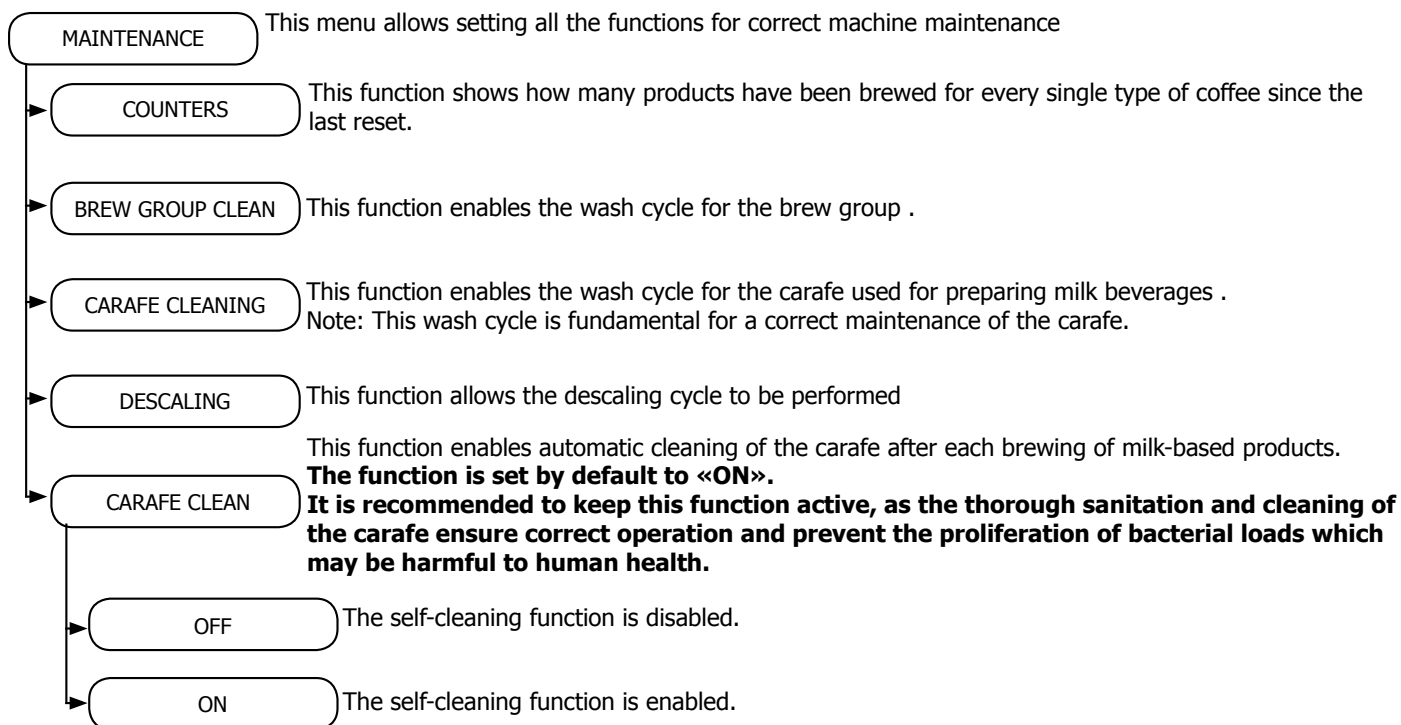

## FACTORY SETTINGS

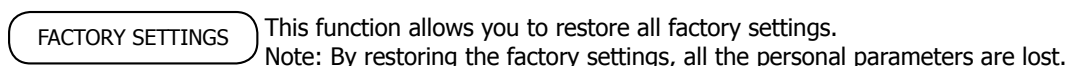

## Machine indications



Close or correctly place the coffee bean hopper inner cover to be able to prepare a beverage.

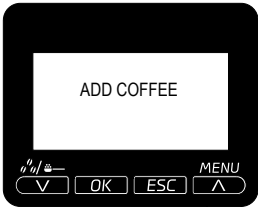

Fill the coffee bean hopper with coffee beans.



Insert the brew group back in place.

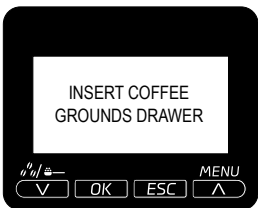

Insert the coffee grounds drawer and the drip tray.

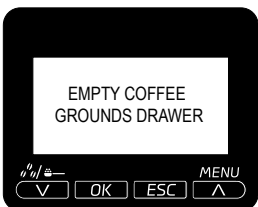

Remove the used grounds drawer and empty the coffee grounds into a suitable container.  
**Note: The used grounds drawer must be emptied only when the machine requires it and with the machine on. If you empty the drawer with the machine turned off it will not record the emptying operation.**

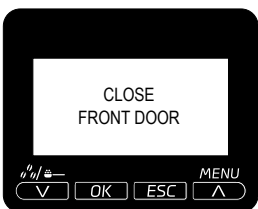

Close the service door to make the machine functional.



Take out the tank and fill it with fresh drinkable water or top it up by means of the special port.



Open the service door and empty the drip tray located under the brew group.  
**Warning: If this operation is performed when the machine is on, it will record the used grounds drawer emptying and will reset the counter; therefore, it is necessary to empty the coffee grounds as well.**





A beverage with milk has been selected. The machine requires the carafe handle spout to be placed into dispensing position. Press the button "ESC" to cancel the selection

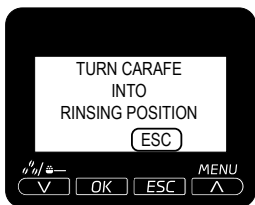

The carafe rinse function has been selected. Press the button "ESC" to cancel the selection.

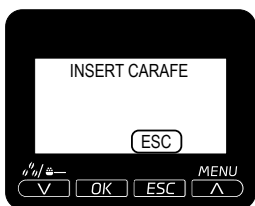

The selected operation requires the milk container for brewing. Insert the container in the machine as specified in the manual. Press the button "ESC" to cancel the selection.



Perform a descaling cycle on the machine. When this message is displayed, it is still possible to use the machine, but its correct operation might be compromised. Damages caused by failure to descale the machine are not covered by warranty.

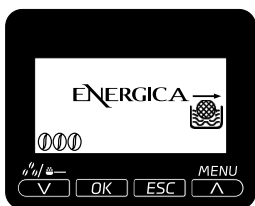

The machine requests the "Intenza" water filter to be replaced with a new one. Replace the filter as described on page 7. The alarm is displayed only if the "Enable Filter" function is set to "ON".



Flashing red light. Machine in Stand-by. The Stand-by settings can be changed. Press the "power" button.

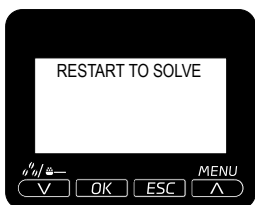

An event has occurred which requires the machine restart. Take note of the code (E xx) shown at the bottom. Switch off the machine, wait 30 seconds and then switch it on again. If the problem persists, contact the service centre.

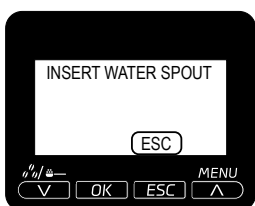

An event has occurred which requires the machine restart. Take note of the code (E xx) shown at the bottom. Switch off the machine, wait 30 seconds and then switch it on again. If the problem persists, contact the service centre.

### 3.3. Operation, cleaning and maintenance

Operating the machine		
1	Fill water tank	
2	Fill the coffee bean hopper	
3	Switch on the appliance	
4	Press the button to start the appliance	
5	Select the desired language	Store
6	Heating	When the heating phase begins, wait for it to finish
7	Rinse	Carry out a rinse cycle for the internal circuits
8	Machine ready	The machine is ready to dispense beverages

CLEANING AND TECHNICAL SERVICING		
A	Empty the dregs drawer	When indicated
B	Empty the drip tray	As necessary (float indicator)
C	Clean the water tank	Weekly
D	Clean the coffee bean hopper	As necessary
E	Clean the casing	As necessary
F	Clean the brewing unit	Every time the coffee bean hopper is filled or weekly
	Lubricate the brewing unit	After 500 dispensing cycles or when the grease is no longer present on the brewing unit
	Clean the unit housing	Weekly
H	Descaling	When indicated

Descaling cycle frequency			
Hardness	Water hardness	Without water filter	With water filter
<b>1</b>	Soft (up to 7°dH)	240 litres (480,000 pulses)	480 litres (960,000 pulses)
<b>2</b>	Medium (7° - 14°dH)	120 litres (240,000 pulses)	240 litres (480,000 pulses)
<b>3</b>	Hard (15° - 21°dH)	60 litres (120,000 pulses)	120 litres (240,000 pulses)
<b>4</b>	Very hard (over 21°dH)	30 litres (60,000 pulses)	60 litres (120,000 pulses)

The default water hardness level is 3. Each litre of water corresponds to approximately 2,000 pulses



# CHAPTER 4

## OPERATING LOGIC

4.1. Water circuit

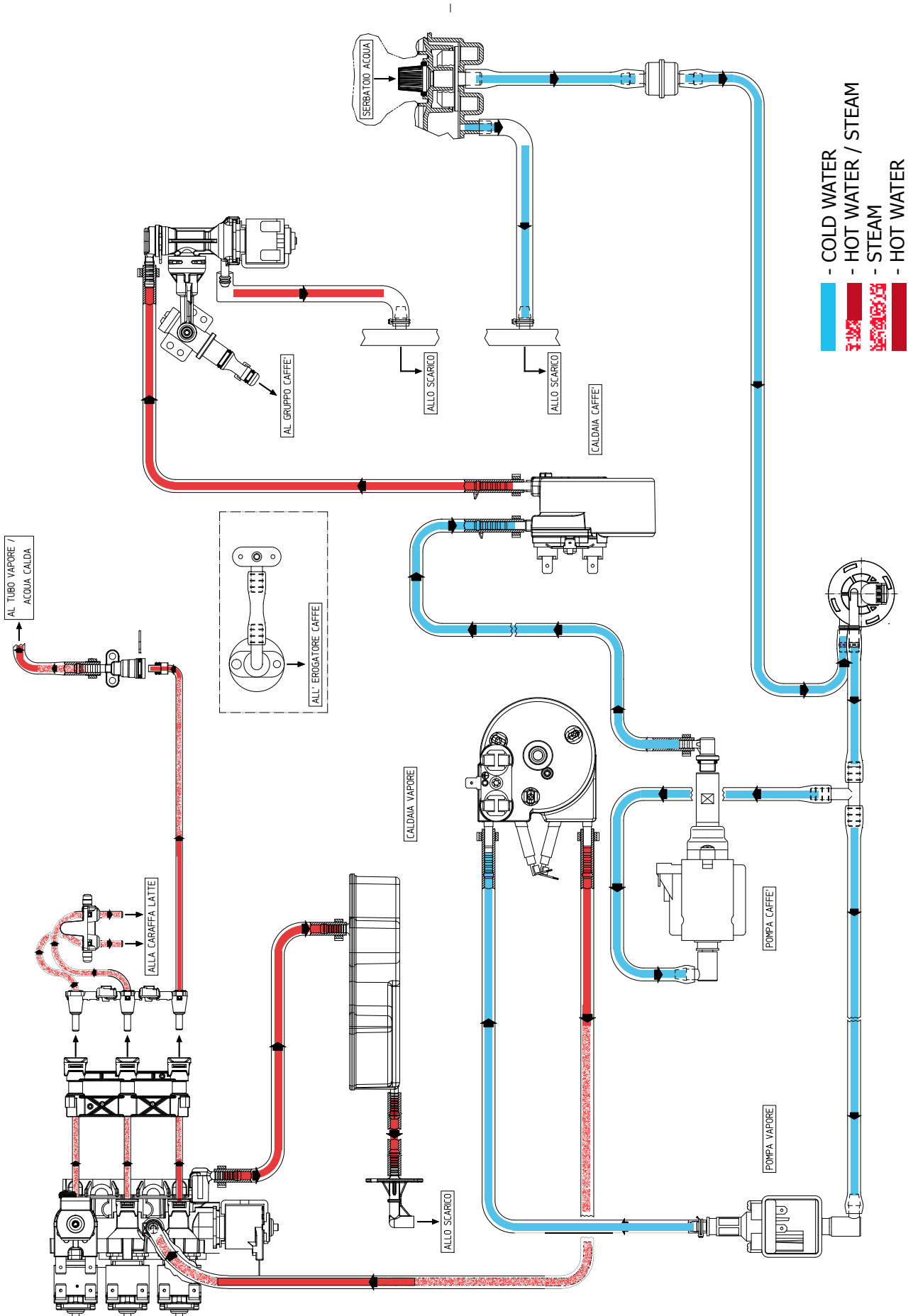

### 4.2.1. Frother unit valve assembly

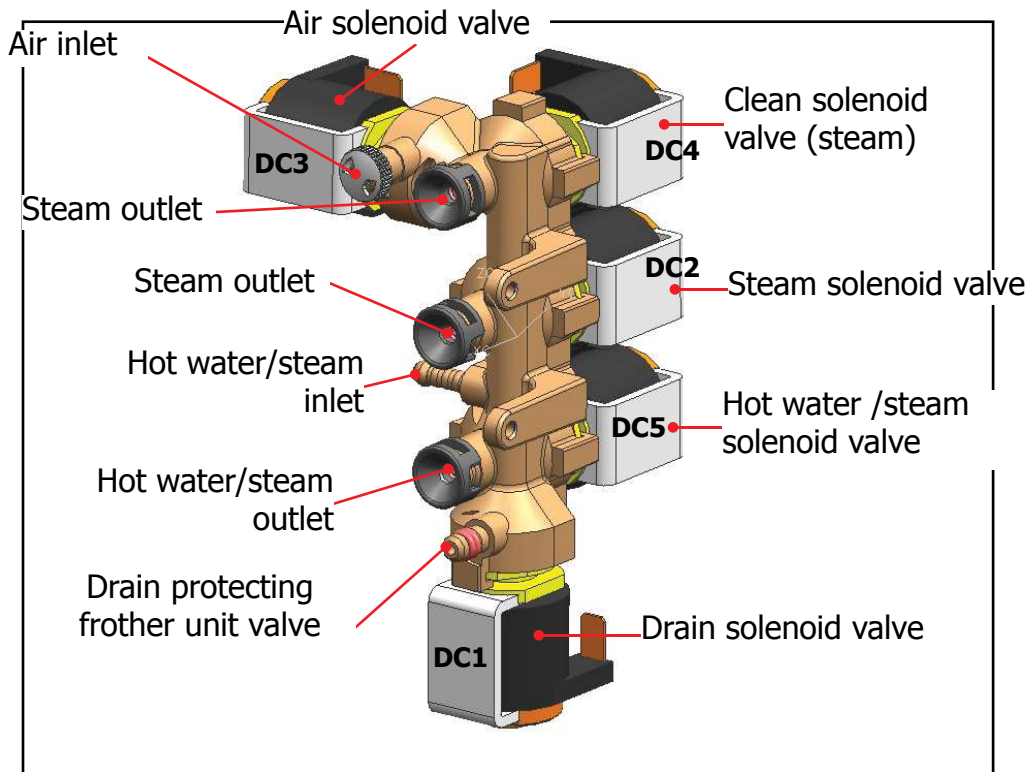

#### Features and requirements

Maximum operating pressure 3 bar

Maximum pressure in the water/steam circuit does not exceed 4.5 bar 0/+1

Hot water temperature 90°

Steam temperature 125°

### 4.2.2. General carafe assembly

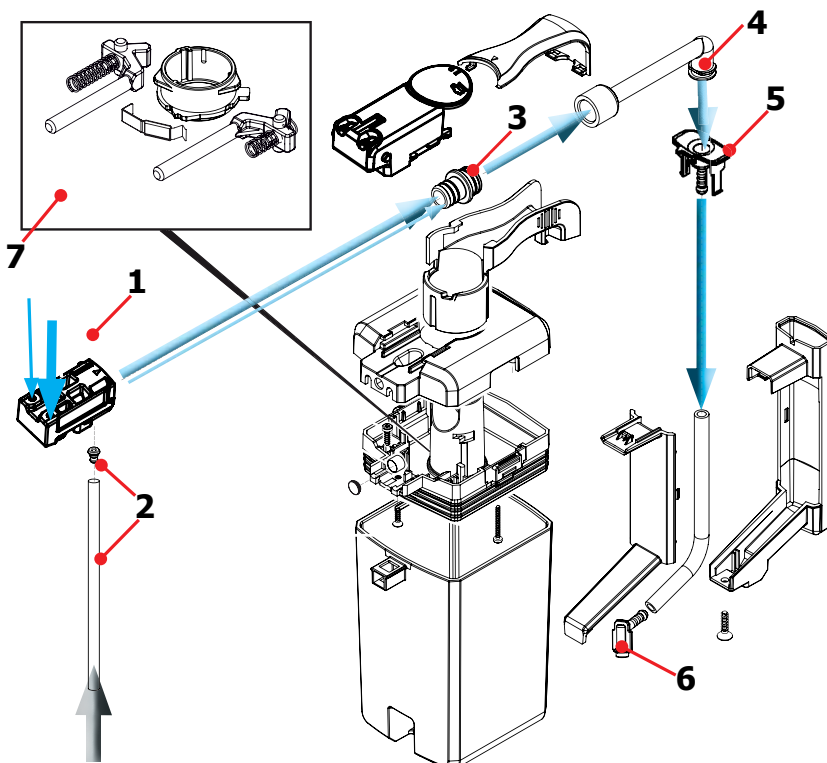

1	Cappuccino valve body
2	Milk suction pipe and attachment
3	Venturi pipe
4	Milk dispenser pipe
5	Upper attachment of drain pipe for carafe
6	Lower attachment of carafe drain pipe
7	Levers, springs and pin for carafe present/missing indication and dispenser positioning

**Functional method for the production of milk-based beverages and circuit cleaning**

When the solenoid valves open and let air or hot water/steam through, the following situations occur:

- **DC3+DC2** STEAM + AIR = Frothing and heating of frothed milk
- **DC2** STEAM FROM CENTRAL HOLE = Heating of non-frothed milk
- **DC4** STEAM FROM LOWER HOLE = Cleaning of milk circuits

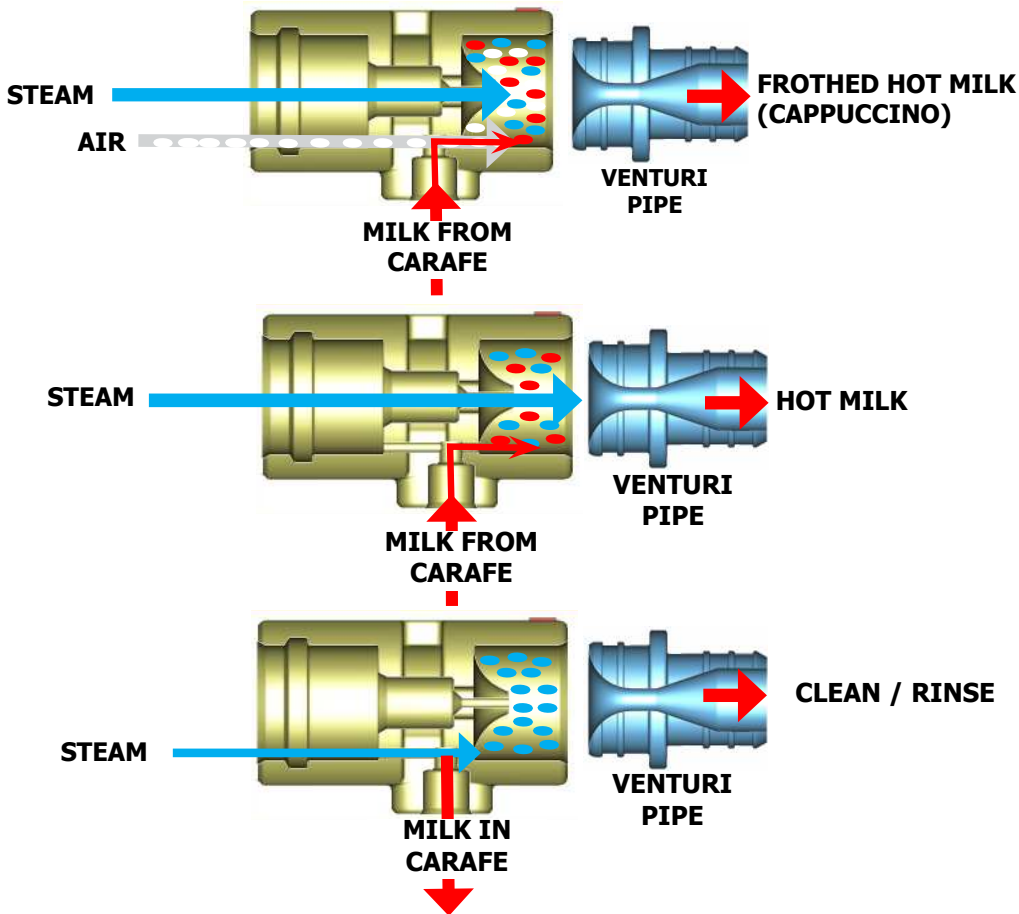

- DC1 = pressure relief valve assembly
- DC2 = steam valve
- DC3 = air valve
- DC4 = clean valve (steam)
- DC5 = hot water/steam valve

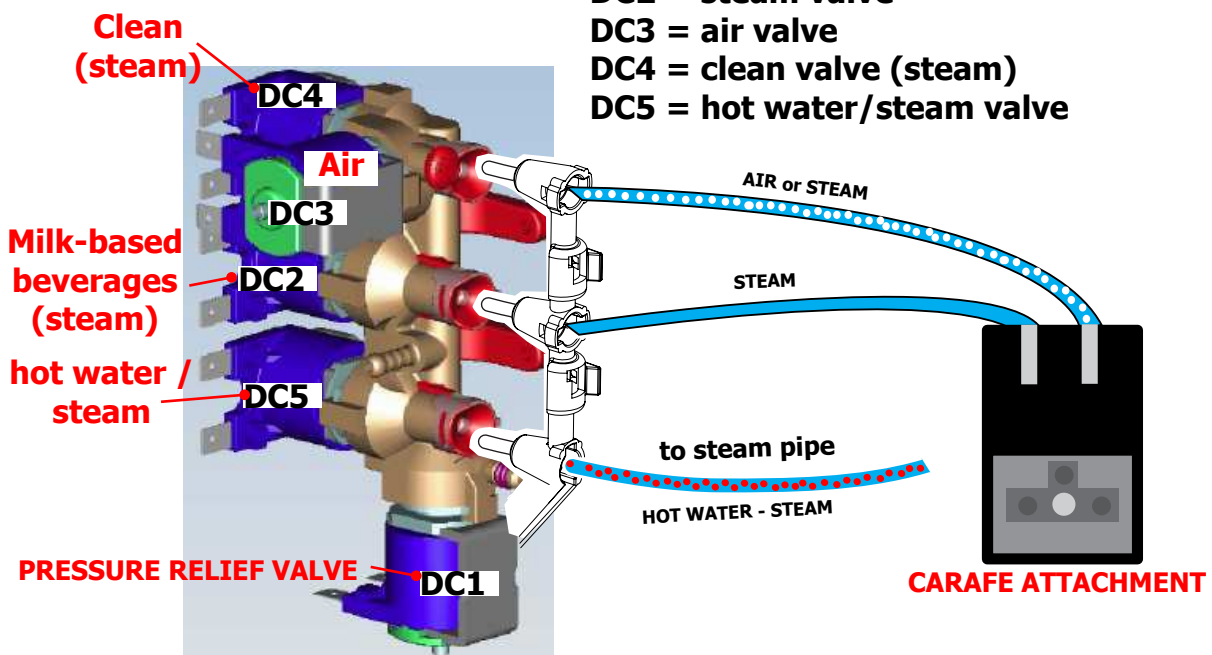

### 4.3. Multi-way valve

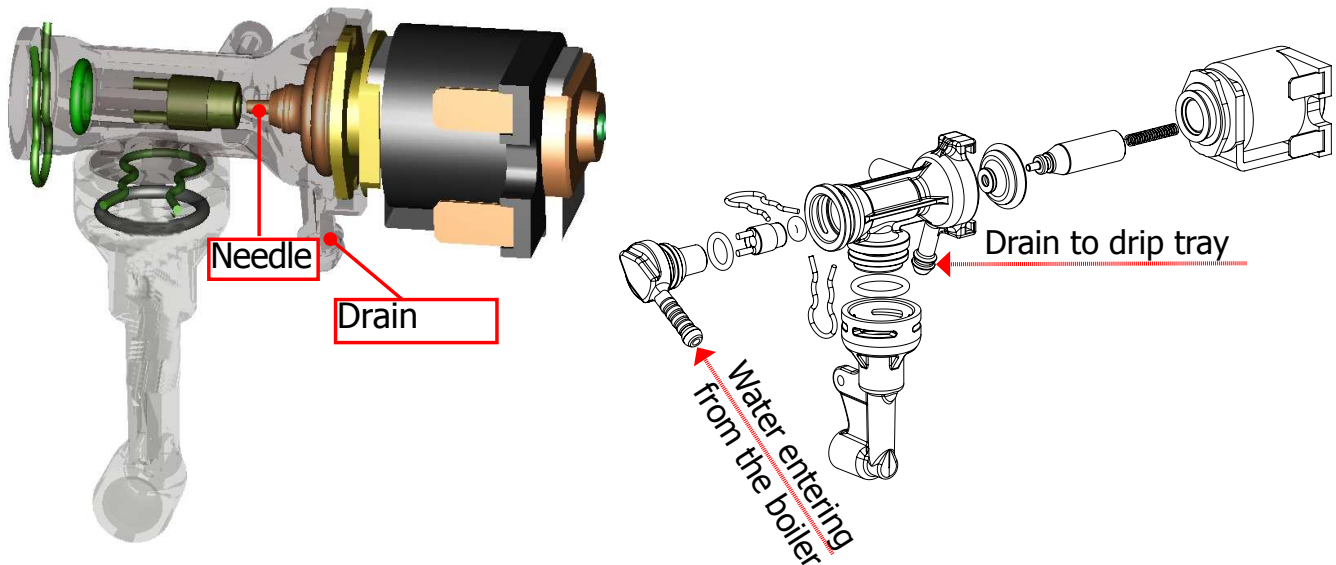

#### Functions:

**Safety valve:** functions as a safety valve by opening towards the drain in the event that the pressure rises above 16-19 bar

**Filling the circuit:** the solenoid valve opens (drain position) and the pump is activated, automatically refilling the circuit by expelling the air in the pipe

**Unit discharge:** before the unit descends it opens briefly, discharging the pressure created to prevent spraying and making the pad drier

**Coffee beverage:** when a coffee beverage is selected, the pump is charged briefly during the grinding process and the valve assumes the drain position in order to fill the pipes with hot water.

### 4.4. Coffee cycle

Main switch ON	START		STOP
Time			
Coffee grinder			Pulses (Dosage)
Heating	approx. 45 sec.		
Pump			Pump activity (turbine pulses) depending on the product quantity selected *
Gearmotor: Brewing unit			
Status	Heating	Ready	Coffee cycle

Notes: \* Only with Pre-brewing



Single microswitch gearmotor

#### Switching on

When the machine is switched on, the gearmotor repositions itself as follows:

- It acts on microswitch 1 (see following chapter)
- The gearmotor changes its rotation direction and moves upwards again by approx. 1-2 mm
- The boiler begins to heat the water for approx. 45 sec., at full power, in order to reach the optimal temperature. The temperature will then remain at a constant level.

#### Coffee cycle

1. The coffee grinder starts the grinding process (controlled by pulses generated by a sensor)
2. The gearmotor (brewing unit) moves to the dispensing position
3. Preliminary dispensing phase (short pump activity, short pause)
4. Product dispensing (the pump operation period is defined by the amount of product dispensed)
5. The gearmotor moves to its home position (the dregs are expelled automatically)



#### 4.5. Single microswitch

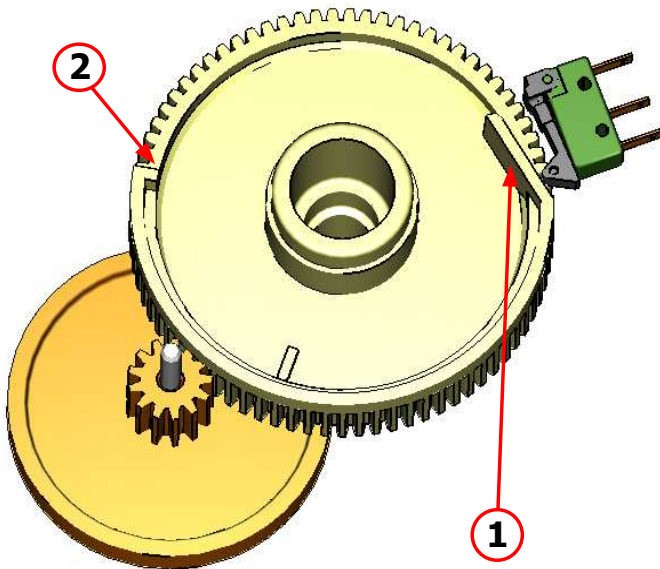

The gearmotor is powered by a direct current motor that engages with the smaller double toothed wheel using a worm screw. The unit is mounted on the axle of the large gear wheel and when a coffee is requested, it moves from the standby position to the dispensing position, and then back to the standby position again.

- Standby position: 1

- Dispensing position: 2

#### 4.6. Temperature sensor (adjustment)

Temp. (°C)	R nom (kΩ)	ΔR (+/- %)
20	61.465	8.6
50	17.599	5.9
75	7.214	4.1
80	6.121	3.7
85	5.213	3.4
90	4.459	3.1
100	3.3	2.5
125	1.653	3.9
150	0.893	5.1

An NTC is used as a temperature sensor; in the event of overheating this reduces boiler element power consumption.

The electronic system detects the current boiler temperature from the drop in voltage of the sensor and adjusts it accordingly.

**Heating element values and corresponding temperatures:** see table

**4.7. Coffee grinder**

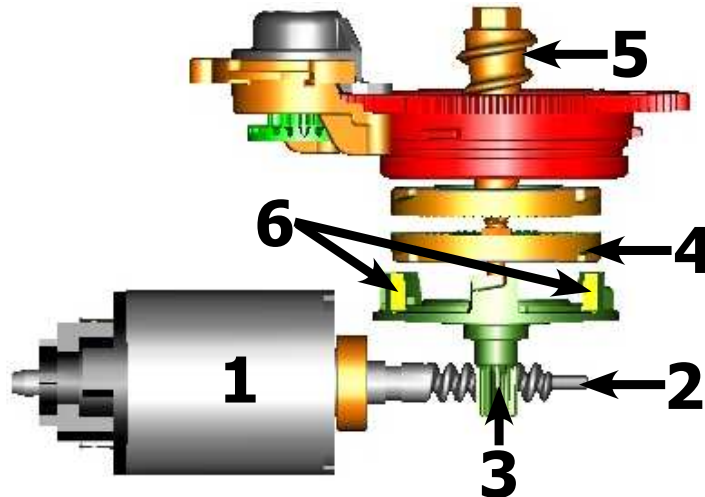

The coffee grinder is driven by a direct current motor (1) using a worm screw helical wheel transmission (2).

The worm screw (2) drives a plastic gear wheel (3), which turns the lower grinder (4) and the increment pin (5)

There are two magnets (6) in the gear wheel; at every rotation these induce two pulses to a Hall sensor, which in turn transmits them to the electronic system.

**4.8. Low bean level detection, dose quantity adjustment, coffee grinder blocked**

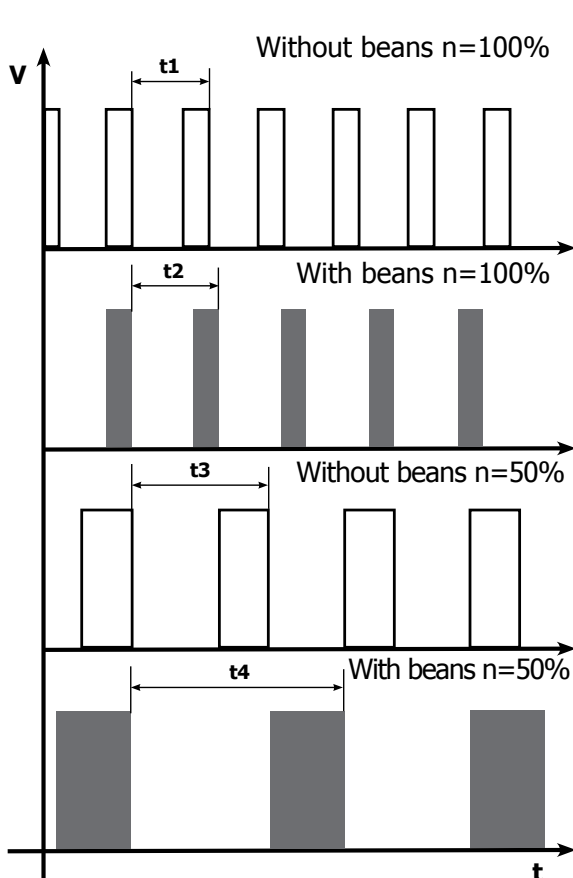

**No coffee**

A low coffee bean level is detected by the Hall sensor, after variations in the pulse frequency (with or without coffee).

If there are no coffee beans (operation while empty), the number of rotations – and therefore the number of pulses – will be greater

**$t_1$  = no coffee indication**

If, however, there are coffee beans, the number of rotations will be lower due to the force created by the grinding

**$t_2$  = no indication**

**$t_3$  and  $t_4$**  = this measurement is taken at the end of each grinding cycle

**Dose quantity adjustment**

The dose quantity is adjusted in accordance with the pulses detected (number of rotations proportional to the weak/medium/strong aroma setting)

**Coffee grinder blockage**

If the coffee grinder becomes blocked for any reason, pulses will no longer be transmitted to the electronic system and the grinder will come to a stop

## 4.9 Dose self-learning (SAS)

The aim of this function is to automatically regulate the average dose of ground coffee (SELF-LEARNING); this takes place with an algorithm based on three pieces of data that the machine receives via the card:

1. Number of coffee grinder pulses during the grinding cycle
2. Max. average value of the power consumed by the group motor during the coffee brewing cycle
3. Aroma selected by the user

The algorithm compares the maximum average value of the power consumed by the group motor with the value listed in the table for the selected aroma, in order to calculate the new grinding pulse value for the next coffee produced.

If the value of the power consumed is lower than the value of the min. current, the grinding pulses will be increased by 2.

If the power consumption value is greater than the maximum current value, the grinding pulses will be decreased by 4.

If the power consumption value falls within the "over-torque" interval, the product will be dispensed and the grinding pulses will be decreased by 10.

If the power consumption value falls within the "abort cycle" interval, the pad will be expelled and the grinding pulses will be decreased by 10.

If the "pre-ground" flavour is selected by the user, no modification will be made.

**This guarantees that, regardless of the coffee type used, the grinding level setting and the wear on the grinders always remains constant.**

Setting/Status		Power consumption in mA	Pulses corrected in the next grinding process	
			Exceeded by	Deficient by
A	Mild aroma	200 - 300 mA	- 4	+2
B	Medium Aroma	301 - 450 mA	- 4	+2
C	Strong Aroma	451 - 600 mA	- 4	+2
D	Over-limit	601 - 800 mA	- 4	
E	Overwork	801 - 1000 mA	- 10	
F	Pad expulsion	> 1000 mA	- 10	

### Important:

For perfect operation, machine adjustment should take place in the area of the fields highlighted in green (A, B, C). When the type or brand of coffee is changed, there may be variations in the size of the beans and their stickiness or roasting level. This leads to variations in power consumption (mA), with resulting excessive or insufficient doses (until the necessary adjustments have been made to compensate for this change).

**Caution: In the case of excessive dosage, powder may be expelled into the dreg drawer. This is not a fault, but can occur during preliminary operation or after a service.**

## 4.10. SBS

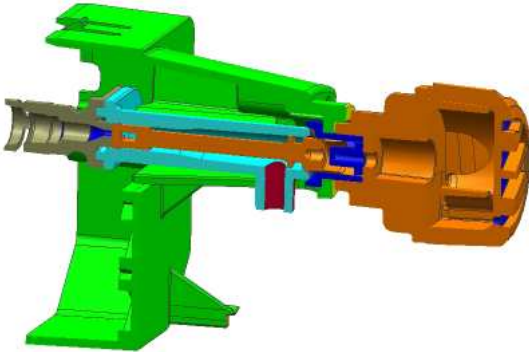

### SBS - Saeco Brewing System - Principle

Controlling the flow speed, which influences the contact time between the coffee and water, changes the extraction and therefore the taste intensity and strength of the coffee.

- Slower flow: strong extraction
- Fast flow: lighter extraction

### SBS / dispensing valve

Turning the SBS control knob leads to brewing taking place inside the brewing unit, where the flow speed is adjusted using a cream valve.

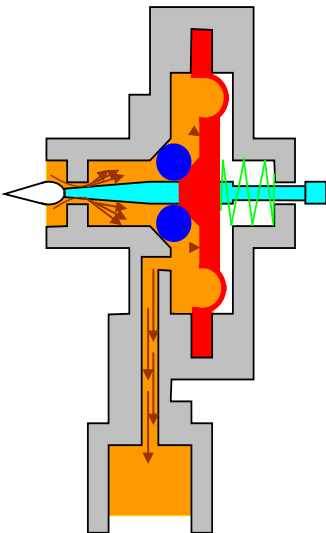

### Cream valve control

#### Fast flow (slight extraction)

If the SBS valve is open, the coffee flows more easily because the pressure is lower and the membrane, with the support of the spring, remains almost in its original position.

The control needle does not close off the opening and the flow is not diminished.

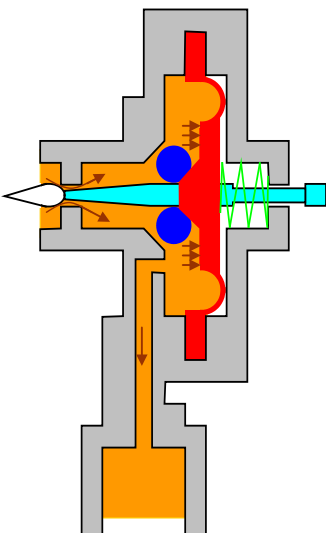

### Cream valve control

#### Slow flow (strong extraction)

The coffee can only be dispensed slowly with a closed SBS valve – a pressure is created which forces the membrane to the side, pushing it against the spring force.

In the next stage, the valve needle closes off the opening, thus reducing the flow.

#### 4.11. Water level detection (water tank)

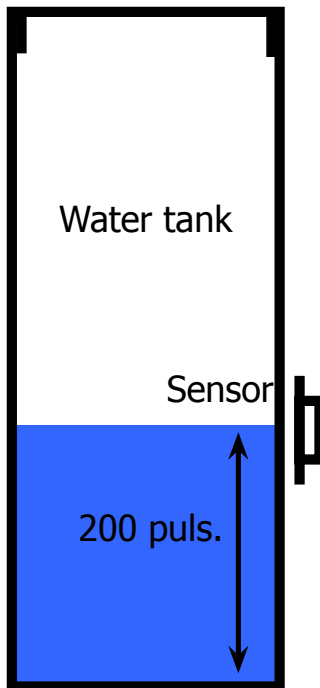

##### “Water low” message (water reserve)

###### Function:

The water level is monitored by a capacitive sensor, located one third of the way up the water tank wall.

If the electronics assembly detects, by means of the sensor, that the amount of water in the tank has dropped below the above mentioned level, a water reserve remains available for the dispensing process underway (this will cover 200 turbine pulses). The product dispensing process will then come to an end.

If a dispensing cycle ends after the sensor has been triggered (in the reserve) then the display “Water low” continues to be displayed during the following dispensing cycle.

#### 4.12. Water level detection (drip tray)

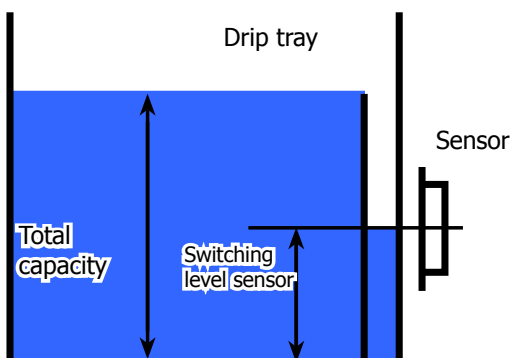

##### “Empty drip tray” - message

###### Function:

The residual water level is monitored using a capacitive sensor. The sensor is located approximately halfway up the upper edge of the drip tray. To ensure the best possible use of the drip tray capacity, the sensor is located near to a dam. Therefore, the drip tray fills up to the upper edge of the dam and overflows inside, triggering the sensor and thus the “Empty drip tray” message.

### 4.13. Descaling request

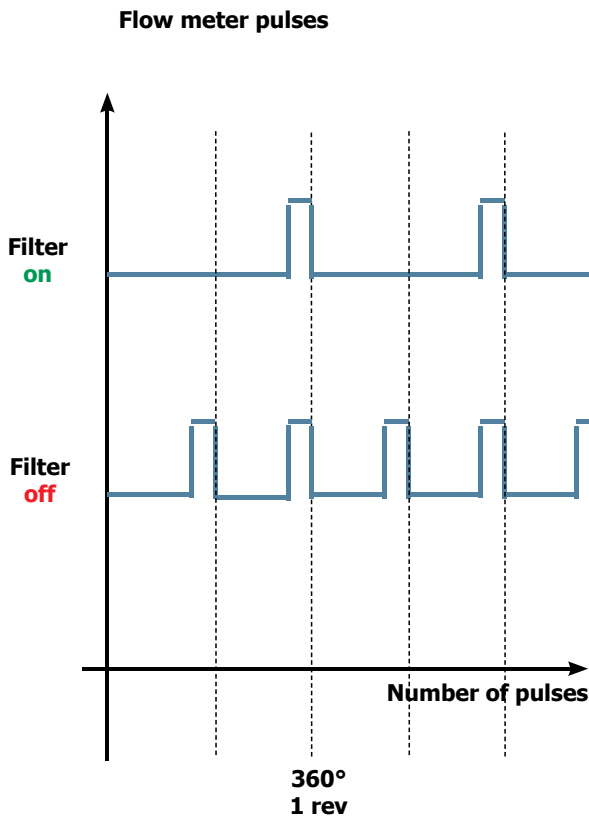

**“Descaling” – message with water filter inserted**

(appliances with display only)

The water hardness is set on the basis of the regional water hardness analysis (1, 2, 3, 4).

**Filter off:**

If the function is turned **off** the electronics assembly monitors the turbine pulses, recording **one pulse each turn**.

**Filter on:**

If the function is turned **on** the electronics assembly monitors the turbine pulses, recording **one pulse every two turns**.

**“Change water filter” message**

The electronics assembly uses the turbine impulses to keep track of the amount of water which has flowed through; after the specified amount (set in accordance with the water hardness level), the “Replace filter” message appears.

### 4.14. Water filter

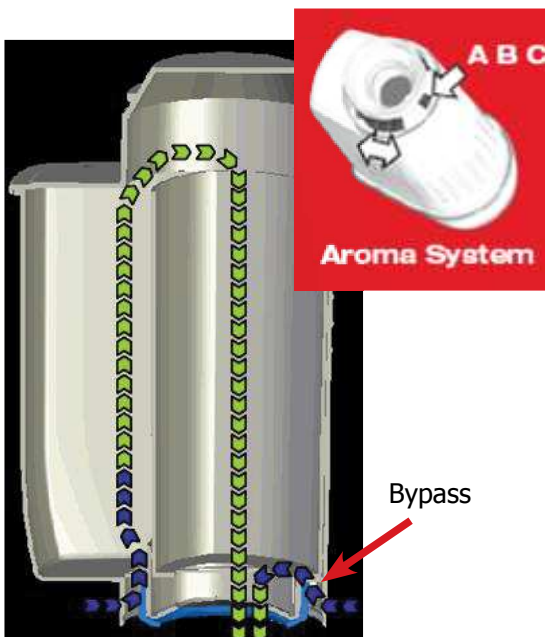

**Water filter**

**Function:**

- Reduced limescale deposits which take longer to form.
- Improved water quality.
- Improved taste due to the ideal water hardness

**Life span / descaling performance:**

- - 10 ° dH
- 60 litres
- 2 months

To achieve the best possible operating mode consistency over the total life span, the water is channelled using a 3-stage bypass (A, B, C) depending on the degree of hardness.

See small image.



# CHAPTER 5

# TROUBLESHOOTING

### 5.1. Test mode

To enter Test Mode:

- Switch on the machine
- Press the four function keys in the sequence indicated below (1,2,3,4) before the heating bar is completed



Entry into Test Mode results in a screen divided into sections, as illustrated in the diagram below

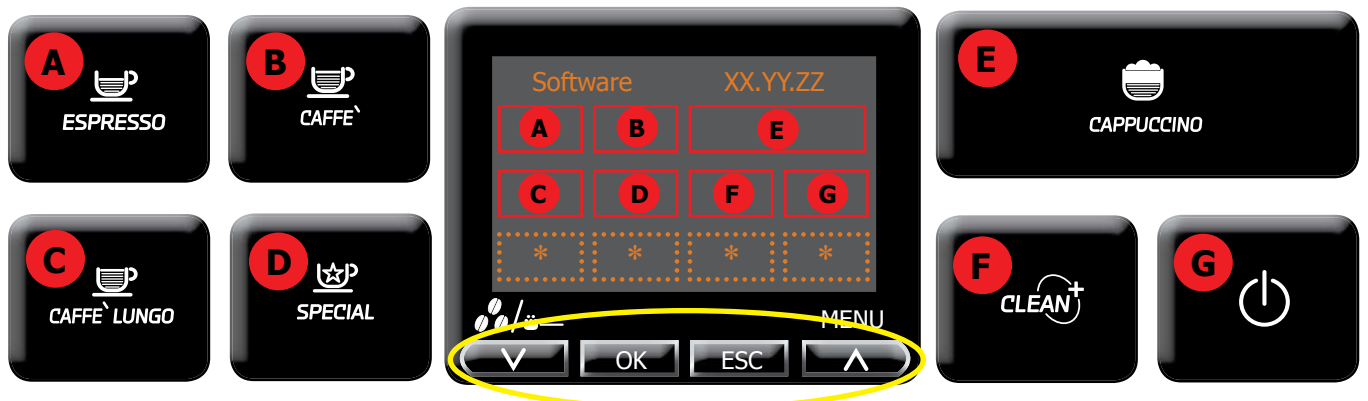

The sectors highlighted in red on the following screens represent the various loads that can be activated by pressing the corresponding keys on the keypads.

This load is deactivated by pressing the same key once more.

Other conditions in which a load can be automatically deactivated are:

- If a work cycle is defined and ends (e.g., coffee grinder or brewing unit)
- A time-out is reached (e.g.: 5 sec for the boiler test)

The 4 buttons highlighted in yellow under the display can be used for navigating within Test Mode. The remaining four dashed sectors are used to indicate the status of the sensors, microswitches or control variables.

If present, the asterisk symbol (\*) in a sector indicates that no function is associated with that sector on that particular screen.



## Software version

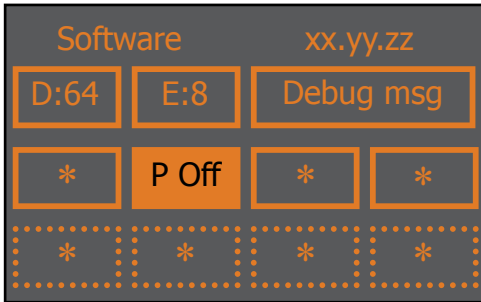

- **(xx.yy.zz)** software version loaded onto the machine
- **(D and E)** are values providing information on the memory settings and must be 64 and 8.
- **P OFF:** if active it enables immediately going onto Standby when the machine is switched on
- **Debug msg:** if active it enables the automatic dosing debug messages for the next restart only

Press  to move on to the next screen

## Keyboard

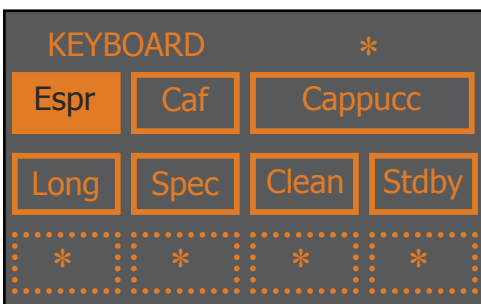

This is the button test page: each beverage corresponds to a box on the display that changes colour when the corresponding button is pressed (e.g.: ESPRESSO)

Press  to move on to the next screen

## Brew Unit

This screen corresponds to the management of the area inside the front hatch.



### Operation:

- **WORK:** if pressed, switches the unit into its work position
- **STOP:** if pressed, stops the unit instantly
- **HOME:** if pressed, switches the unit into its Home position
- **DREG UP:** increases the coffee dregs counter
- **DREG DOWN:** decreases the coffee dregs counter

### Indicators:

- **mA:** indicates moment by moment the maximum current (in mA) consumed by the unit when moving. Its value must not exceed 300 mA
- **H/W:** becomes active (illuminated) when the unit reaches a "Work" position
- **Pres:** if active, this indicates that the unit is inserted
- **DDr:** if active, this indicates that the dregs counter is inserted
- **Door:** if active, this indicates that the front hatch is closed

Press  to move on to the next screen

## HydraulicCircuit

This screen corresponds to water circuit management.

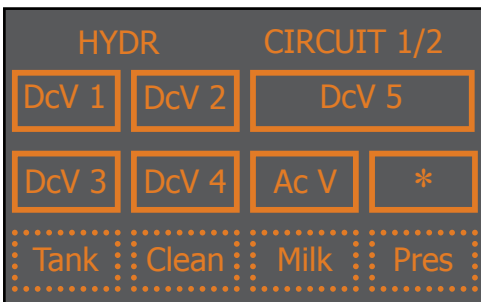

### Operation:

- **Ac V:** if pressed, activates the 230V solenoid valve
- **Dc V1:** activates the 24V solenoid valve for draining
- **Dc V2:** activates the 24V steam dispensing solenoid valve
- **Dc V3:** activates the 24V milk frothing solenoid valve
- **Dc V4:** activates the 24V solenoid valve for milk circuit cleaning
- **Dc V5:** activates the 24V hot water dispensing solenoid valve

### Indicators

- **Tank:** indicates the status of the water tank level sensor. If activated, the sensor signals that the level has been reached
- **Clean:** if activated, it indicates that the milk carafe is in the CLEAN position.
- **Milk:** if activated, it indicates that the milk carafe is in the MILK dispensing position
- **Pres:** if activated, it indicates that the milk carafe is inserted

Press  to move on to the next screen

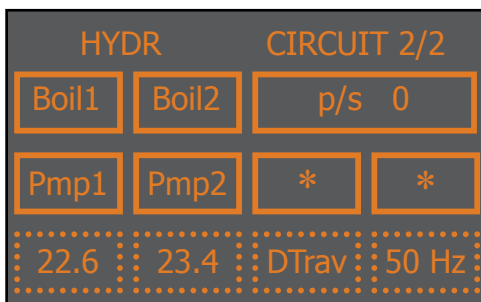

### Operation:

- **Boil1:** if pressed, this activates the coffee boiler. The boiler is deactivated either by pressing the button again or automatically after 5 seconds. The temperature is indicated in the corresponding window at the bottom
- **Boil2:** if pressed, activates the steam/hot water boiler. The boiler is deactivated either by pressing the button again or automatically after 5 seconds. The temperature is indicated in the corresponding window at the bottom
- **Pmp1:** activates the hot water dispensing pump. The pump is switched off by pressing the button once more
- **Pmp2:** activates the hot water/steam dispensing pump. The pump is switched off by pressing the button once more

### Indicators

- **p/s:** indicates moment by moment the water flow rate in the turbine, expressed in pulses per second. When coffee pump 1 is switched on and the coffee solenoid valve is on (AcV on the previous screen) the value must be no lower than 10 p/sec. When hot water/steam pump 2 is switched on and the drain solenoid valve is on (DcV5 on the previous screen) the value must be no lower than 5 p/sec.
- **50 Hz:** indicates the mains electricity voltage frequency.
- **DTray:** indicates the status of the tray level sensor. If activated, the sensor signals that the level has been reached

Press  to move on to the next screen

## Grinder

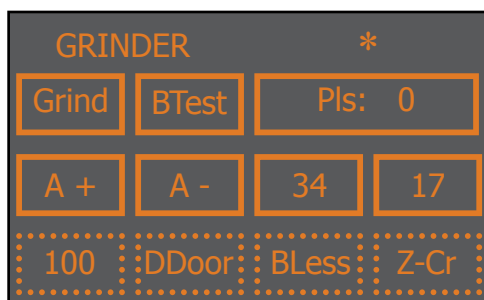

### Operation:

- **Grind:** if pressed, activates the coffee grinder. To stop it, press the button again. If the coffee grinder is not stopped, it will grind for 200 pulses; the corresponding countdown appears in the window.
- **BTEST:** if pressed, activates the coffee grinder. To stop it, press the button again. If stopped, the no-coffee test is run. At the end of the test, 2 values will appear in the "instantaneous threshold" and "reference threshold" windows: if "instantaneous threshold" is less than the "reference threshold" the system considers that the coffee grinder is empty

**Indicators:**

- **Pls**: indicates, during grinding, the real-time grinding pulse countdown
- **Bless**: This is activated when the system detects there is no coffee. To cancel the alarm you need to raise and lower the bean cover to simulate coffee loading
- **BDOOR**: indicates the status of the bean hopper door sensor (if active, it indicates that the door is closed)
- **A+**: increases the number of pulses for a medium aroma
- **A-**: decreases the number of pulses for a medium aroma
- **Z-cr**:... not used

**The value at bottom left is the number of pulses for a medium aroma: it is modified manually with the "A+" and "A-" keys or automatically by the automatic dosing algorithm**

Press  to move on to the next screen

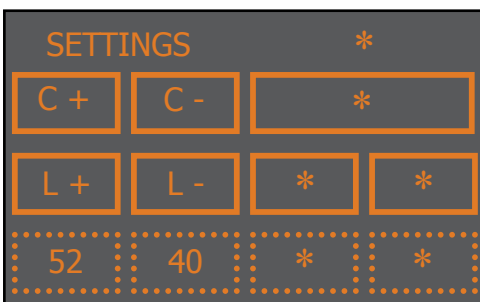
**Display****Operation:**

- **C+**: increases the contrast of the display
- **C-**: decreases the contrast of the display
- **L+**: increases the brightness of the display
- **L-**: decreases the brightness of the display

**Indicators**

- **The values at the bottom are indices representing the brightness and contrast: in this case these values are not saved to eeprom as they have solely a test function**

Press  to move on to the next screen

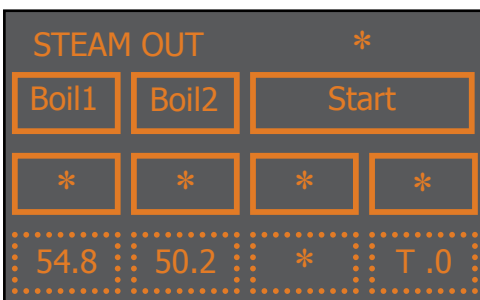
**Steam Out****Operation:**

- **Boil1**: illuminates when the coffee boiler is powered
- **Boil2**: illuminates when the steam boiler is powered
- **Start**: starts the draining process

**Indicators**

- **The values at the bottom are the temperatures of the two boilers and the countdown (T.O) before the machine requests switching off.**

**This is the last screen of the Test Mode. Press  to go back to the previous screens.**

**On each screen, pressing ESC exits the TEST mode and restarts the appliance in normal mode.**

### 5.2. Diagnostics mode

To enter Diagnostics mode:



- Switch on the machine
- Press the four function keys in the sequence indicated below (1,2,3,4) before the heating bar is completed



Entering Diagnosis Mode shows a screen like the one in the following diagram and pressing scrolls through all the menus present



MENU	DESCRIPTION
PRODUCT COUNTERS	This represents the number of times the C:A: has dispensed each beverage
ERROR COUNTERS	This displays the total number of "out of order" (fail) errors occurring in the system and enables resetting. The max number of counted "fails" is 20
WATER COUNTERS	This shows the water consumption (in pulses) after dispensing beverages, for the descaling cycle, the unit cleaning cycle and filter activation
BREWING UNIT CLEANING	This shows the water consumption after the last unit cleaning cycle and the number of times cleaning has been performed
MAX GRINDER DOSE	This is used to select the highest dose threshold the coffee grinder can accommodate
MAX GROUND	This is used to select the maximum number of coffee grounds batches. The range of the number of coffee grounds batches can vary from 10 to 20
HOTWATER FLOWRATE	This is used to select the maximum delay between two water pulses in the flow meter
CUP TEMPERATURE	This is used to select the average or normal temperature of the coffee in a cup

Press the  or  buttons to move the cursor onto the desired beverage and press  to enter the submenu

**1. PRODUCT COUNTERS**

• ESPRESSO (default 0)	• dispensing no.
• COFFEE (default 0)	• dispensing no.
• LONG COFFEE (default 0)	• dispensing no.
• HOT WATER (default 0)	• dispensing no.
• CAPPUCCINO (default 0)	• dispensing no.
• LATTE MACCHIATO (default 0)	• dispensing no.
• HOT MILK (default 0)	• dispensing no.

**2. ERROR COUNTERS**

• ERRORS LOG	• ERROR CODE (default 0)	ERROR CODE - the code representing the type of error that has occurred (see Tab. 5.3 Error messages)
	• ERROR INDEX (default 0)	NUMERICAL POSITION - represents the numerical position of the error in the internal list for a max no. of 20
	• ERROR TEXT (default 0)	ERROR DESCRIPTION - a text description of the type of error that has occurred

• ERRORS RESET	All the errors are reset
----------------	--------------------------

**3. WATER COUNTERS**

• DESCALING CYCLES	• WATER SINCE LAST CYCLES	Represents the consumption of water since the last descaling cycle
	• WATER SINCE SECOND	As above but for the penultimate descaling cycle
	• WATER SINCE THIRD	As above but for the third last descaling cycle
	• WATER SINCE LAST CYCLE	total no. of descaling cycles performed
• BREWING UNIT CLEANING	• SINCE LAST (default 0)	Represents the consumption of water since the last unit cleaning cycle. When performed it goes back to 0.
	• NUMBER OF EXECUTION (default 0)	Represents the number of unit cleaning cycles carried out on the C.A.

• WATER FILTER	• SINCE LAST RESET (default 0)	Represents the consumption of water since the last filter activation cycle. When performed it goes back to 0
	• NUMBER OF RESET (default 0)	total no. of filter activation cycles performed.

• WATER SINCE PRODUCT	Total consumption of water in litres (default 0).
-----------------------	---

<b>4. MAX GRINDER DOSE</b>	100 to 170 (default 170)
----------------------------	--------------------------

<b>5. MAX GROUND</b>	10 to 20 (default 10)
----------------------	-----------------------

<b>6. HOTWATER FLOWRATE</b>	100 to 150 (default 120)
-----------------------------	--------------------------

<b>7. CUP TEMPERATURE</b>	75 to 85 (default 78)
---------------------------	-----------------------

### 5.3. Test mode Energica Focus

To enter Test Mode:

- Switch on the machine
- Press the four function keys in the sequence indicated below (1,2,3,4) before the heating bar is completed

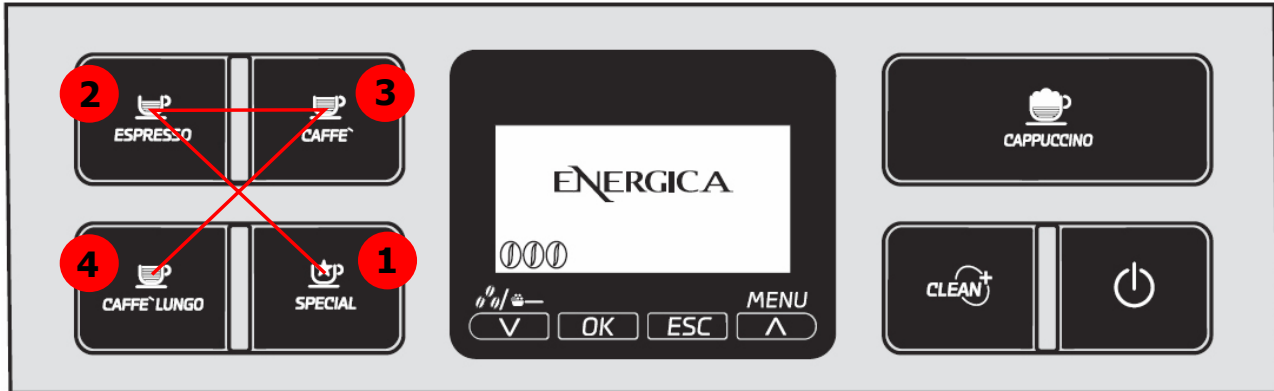

Entry into Test Mode results in a screen divided into sections, as illustrated in the diagram below

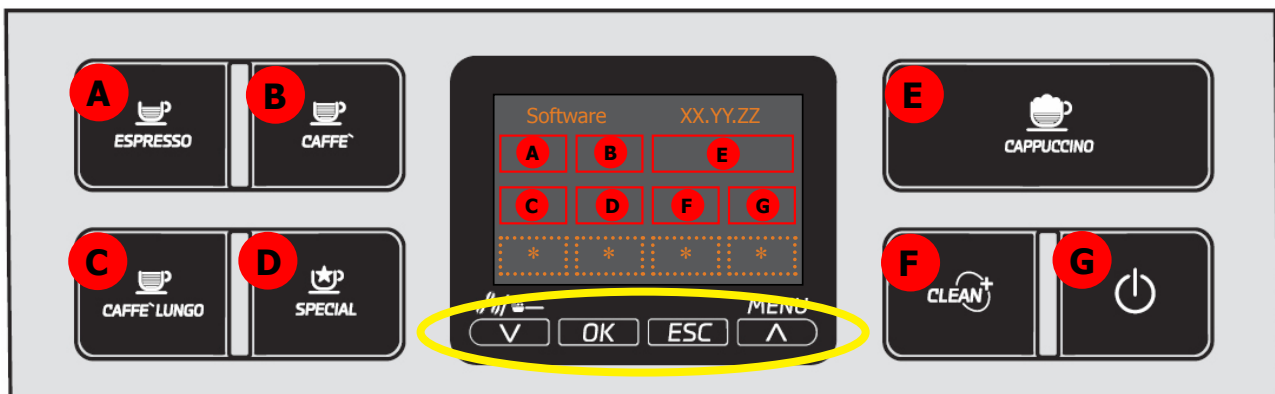

The sectors highlighted in red on the following screens represent the various loads that can be activated by pressing the corresponding keys on the keypads.

This load is deactivated by pressing the same key once more.

Other conditions in which a load can be automatically deactivated are:

- If a work cycle is defined and ends (e.g., coffee grinder or brewing unit)
- A time-out is reached (e.g.: 5 sec for the boiler test)

The 4 buttons highlighted in yellow under the display can be used for navigating within Test Mode. The remaining four dashed sectors are used to indicate the status of the sensors, microswitches or control variables.

If present, the asterisk symbol (\*) in a sector indicates that no function is associated with that sector on that particular screen.

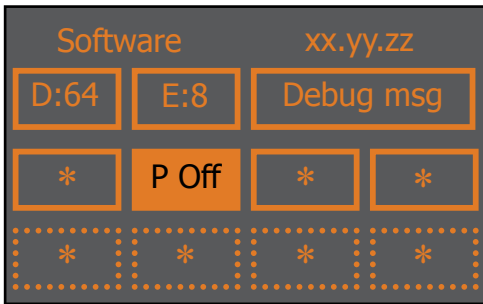

- **(xx.yy.zz)** software version loaded onto the machine
- **(D and E)** are values providing information on the memory settings and must be 64 and 8.
- **P OFF:** if active it enables immediately going onto Standby when the machine is switched on
- **Debug msg:** if active it enables the automatic dosing debug messages for the next restart only

Debug msg active

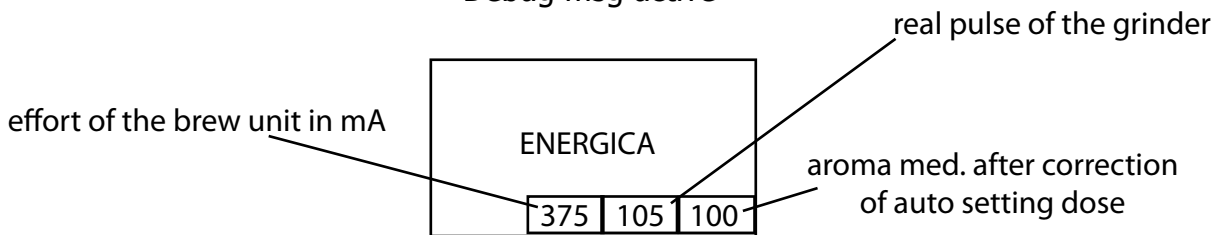

Press to move on to the next screen

### Keyboard

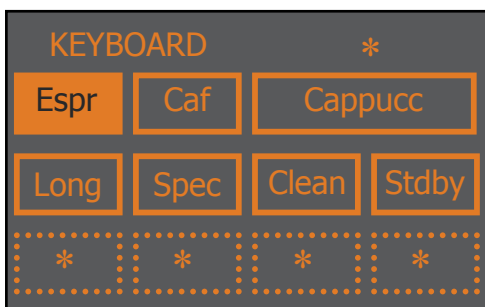

This is the button test page: each beverage corresponds to a box on the display that changes colour when the corresponding button is pressed (e.g.: ESPRESSO)

Press to move on to the next screen

### Brew Unit

This screen corresponds to the management of the area inside the front hatch.



**Operation:**

- **WORK:** if pressed, switches the unit into its work position
- **STOP:** if pressed, stops the unit instantly
- **HOME:** if pressed, switches the unit into its Home position
- **DREG UP:** increases the coffee dregs counter
- **DREG DOWN:** decreases the coffee dregs counter

**Indicators:**

- **mA:** indicates moment by moment the maximum current (in mA) consumed by the unit when moving. Its value must not exceed 300 mA
- **H/W:** becomes active (illuminated) when the unit reaches a "Work" position
- **Pres:** if active, this indicates that the unit is inserted
- **DDr:** if active, this indicates that the dregs counter is inserted
- **Door:** if active, this indicates that the front hatch is closed

Press to move on to the next screen



## HydraulicCircuit

This screen corresponds to water circuit management.

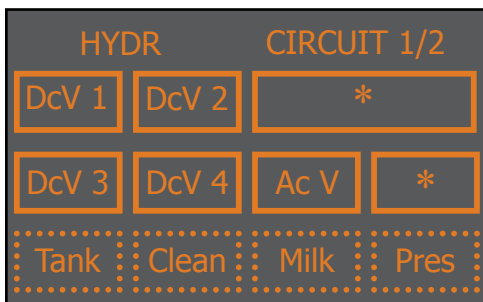

### Operation:

- **Ac V**: if pressed, activates the 230V solenoid valve
- **Dc V1**: activates the 24V solenoid valve for draining
- **Dc V2**: activates the 24V steam dispensing solenoid valve
- **Dc V3**: activates the 24V milk frothing solenoid valve
- **Dc V4**: activates the 24V solenoid valve for milk /hot water circuit cleaning

### Indicators

- **Tank**: indicates the status of the water tank level sensor. If activated, the sensor signals that the level has been reached
- **Clean**: if activated, it indicates that the milk carafe is in the CLEAN position.
- **Milk**: if activated, it indicates that the milk carafe is in the MILK dispensing position
- **Pres**: if activated, it indicates that the milk carafe is inserted

Press  to move on to the next screen

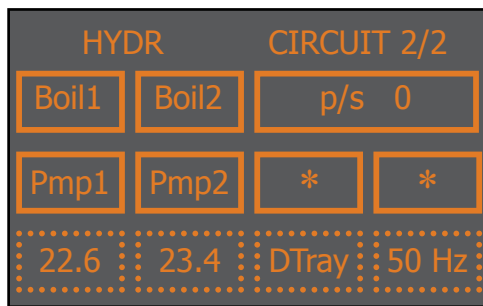

### Operation:

- **Boil1**: if pressed, this activates the coffee boiler. The boiler is deactivated either by pressing the button again or automatically after 5 seconds. The temperature is indicated in the corresponding window at the bottom
- **Boil2**: if pressed, activates the steam/hot water boiler. The boiler is deactivated either by pressing the button again or automatically after 5 seconds. The temperature is indicated in the corresponding window at the bottom
- **Pmp1**: activates the hot water dispensing pump. The pump is switched off by pressing the button once more
- **Pmp2**: activates the hot water/steam dispensing pump. The pump is switched off by pressing the button once more

### Indicators

- **p/s**: indicates moment by moment the water flow rate in the turbine, expressed in pulses per second. When coffee pump 1 is switched on and the coffee solenoid valve is on (AcV on the previous screen) the value must be no lower than 10 p/sec. When hot water/steam pump 2 is switched on and the drain solenoid valve is on (DcV5 on the previous screen) the value must be no lower than 5 p/sec.
- **50 Hz**: indicates the mains electricity voltage frequency.
- **DTray**: indicates the status of the tray level sensor. If activated, the sensor signals that the level has been reached

Press  to move on to the next screen

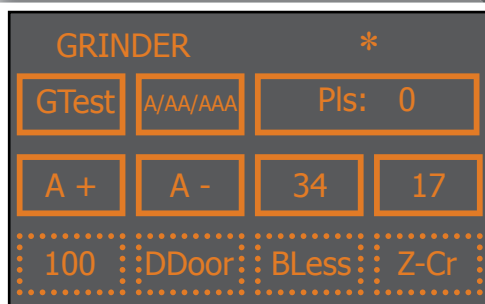

## Grinder

### Operation:

- **A/AA/AAA Aroma A=mild AA=medium AAA=strong**
- **GTEST**: if pressed, activates the coffee grinder. To stop it, press the button again. If stopped, the no-coffee test is run. At the end of the test, 2 values will appear in the "instantaneous threshold" and "reference threshold" windows: if "instantaneous threshold" is less than the "reference threshold" the system considers that the coffee grinder is empty

### Indicators:

- **Pls**: indicates, during grinding, the real-time grinding pulse countdown
- **BLess**: This is activated when the system detects there is no coffee. To cancel the alarm you need to raise and lower the bean cover to simulate coffee loading
- **BDOOR**: indicates the status of the bean hopper door sensor (if active, it indicates that the door is closed)
- **A+**: increases the number of pulses for a medium aroma
- **A-**: decreases the number of pulses for a medium aroma
- **Z-cr**:... not used

**The value at bottom left is the number of pulses for a medium aroma: it is modified manually with the "A+" and "A-" keys or automatically by the automatic dosing algorithm**

Press  to move on to the next screen



## Display

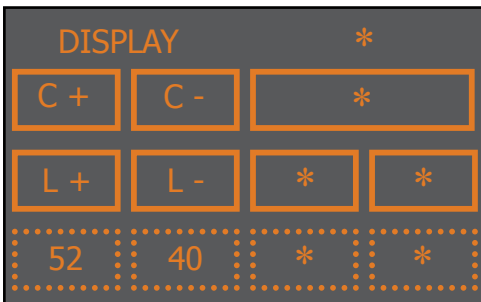

### Operation:

- **C+**: increases the contrast of the display
- **C-**: decreases the contrast of the display
- **L+**: increases the brightness of the display
- **L-**: decreases the brightness of the display

### Indicators

- **The values at the bottom are indices representing the brightness and contrast: in this case these values are not saved to eeprom as they have solely a test function**

Press  to move on to the next screen

## Steam Out

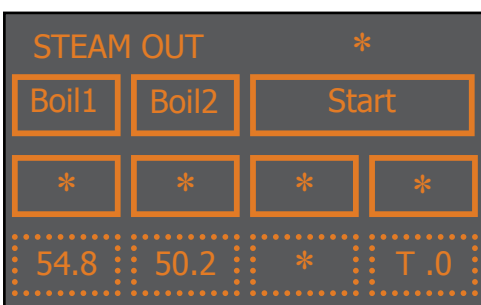

### Operation:

- **Boil1**: illuminates when the coffee boiler is powered
- **Boil2**: illuminates when the steam boiler is powered
- **Start**: starts the draining process

### Indicators

- **The values at the bottom are the temperatures of the two boilers and the countdown (T.O) before the machine requests switching off.**

This is the last screen of the Test Mode. Press  to go back to the previous screens.

On each screen, pressing ESC exits the TEST mode and restarts the appliance in normal mode.

### 5.4. Error messages

Code	Brief description	Description
01	coffee grinder blocked	The coffee grinder is blocked (grinder blades jammed or sensor not reading properly)
03	Brewing unit blocked in 'work' position	Descent time-out exceeded
04	Brewing unit blocked in 'home' position	Ascent time-out exceeded
05	Water circuit blocked	No water in flow meter or flow meter not turning (jammed)
06	Frother unit solenoid valve	Frother unit solenoid valve short-circuit
10	Coffee boiler short-circuit	Coffee boiler temperature sensor short-circuit
11	Coffee boiler in open circuit	Coffee boiler temperature sensor in open circuit
12	Steam boiler short-circuit	Steam boiler temperature sensor short-circuit
13	Steam boiler in open circuit	Steam boiler temperature sensor in open circuit
14	Various temperature errors (in the coffee boiler)	Coffee boiler temperatures out of control
15	Various temperature errors (in the steam boiler)	Steam boiler temperatures out of control
16	Group motor short-circuit	Brewing unit microswitch short-circuit
17	Not used	
18	Clock error	Memory fault or impossible to set
19	No zero crossing	No zero crossing on card, could be caused by power card
20	Not used	



# CHAPTER 6

# STANDARD CHECKS

### 6.1. Repair schedule

	Action
<b>1</b>	Visual inspection (transport damage)
<b>2</b>	Machine data check (rating plate)
<b>3</b>	Operational check / problem analysis
<b>4</b>	Opening machine
<b>5</b>	Visual inspection
<b>6</b>	Operational tests
<b>7</b>	Repairing the faults encountered
<b>8</b>	Checking any modifications (view info, new sw, etc.)
<b>9</b>	Service activities in accordance with the operating schedule
<b>10</b>	Internal cleaning
<b>11</b>	Operational test while the appliance is open
<b>12</b>	Assembly
<b>13</b>	Final inspection test
<b>14</b>	Draining the circuit (in winter)
<b>15</b>	External cleaning
<b>16</b>	Lubricating the brewing unit with suitable grease
<b>17</b>	Insulation test HG 701 (dielectric)
<b>18</b>	Documentation

### 6.2. Service schedule

**S** Replacement

**ES** Visual inspection

**D** Descaling

**CF** Operative check

**P** Cleaning

**TR** Noise test

**R** Adjustment

Component	Action	Support/tool
Water filter:	<b>P/S/CF</b>	
Water tank lip seal	<b>S/CF</b>	
Boiler pin O-ring	<b>S/CF</b>	
Brewing unit	<b>ES/P/CF</b>	Grease solvent / Grease
Hoses, attachments and Oetiker clamps	<b>ES/CF</b>	
Coffee circuit pump	<b>ES/TR/CF</b>	
Hot water/steam circuit pump	<b>ES/TR/CF</b>	
Gearmotor:	<b>ES/TR/CF</b>	
Coffee grinder	<b>P/R/CF</b>	Vacuum cleaner / brush
Water circuit	<b>D/CF</b>	Saeco descaler
Frothing valve assembly	<b>ES/S/CF</b>	
Multi-way valve (solenoid pilot)	<b>ES/S/CF</b>	

**6.3. Final test**

<b>Test</b>	<b>Procedure</b>	<b>Support/tool</b>	<b>Standard</b>	<b>Tolerance</b>
Espresso	2-3 Espressos for adjustment purposes	Measuring scoop	Same amount	15%
Coffee	2-3 Coffees for adjustment purposes	Measuring scoop	Same amount	15%
Noise			Standard	
Amount of cream	Blow into the cup until the cream separates		The cream should come together again to form a complete layer	
Cream colour			Hazel brown	
Temperature	Reading taken while dispensing	Thermometer	84 °C	± 4 °C
Grinding level	Check the grain size of the ground coffee			
Hot water	Dispense water			
Steam	Dispense steam			
Dreg drawer missing indication	Remove the dreg drawer		Dreg drawer missing indication	
Missing indication coffee beans	Start brewing a coffee while the coffee bean hopper is empty		Missing indication coffee beans	



# CHAPTER 7

# DISASSEMBLY

**7.1. Outer elements**



Remove the water tank, coffee container cover and water drip tray



Take off the caps covering the screws and unscrew them. Raise the rear cover and take it off



Extract the PWR cover



Loosen the screws as indicated and remove the rear frame

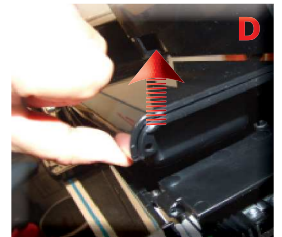
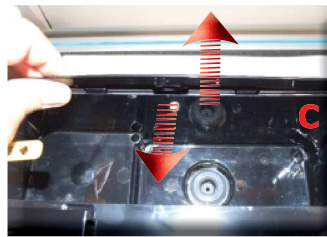

Unscrew the screws as indicated under the water container cover (A) and the coffee bean hopper (B). Unhook and gently raise the casing cover (C) by a few cm. Go onto the opposite side and raise the cover as shown in the photo (D)

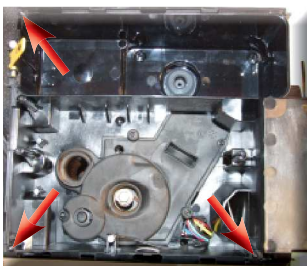

Unscrew the screws shown and pull out the RH and LH panel assembly

**7.2. Coffee grinder**

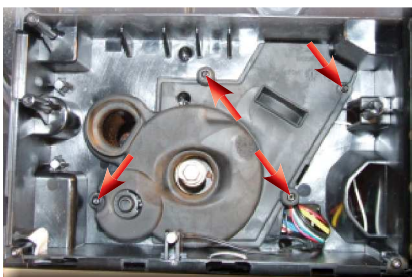

Loosen the screws as illustrated and remove the sound insulating cover of the coffee grinder



Raise the coffee grinder and remove the connections



When reassembling the coffee grinder, make sure the spring is repositioned correctly (see photo)



### 7.3. Grinder blades

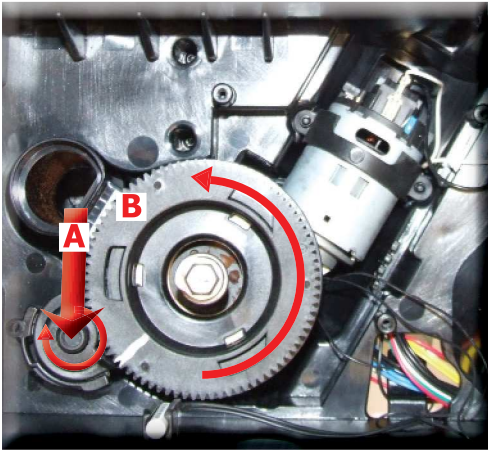

To extract the top support of the appliance, press on the grinding adjustment spindle (A) and turn the support anticlockwise until it unhooks.

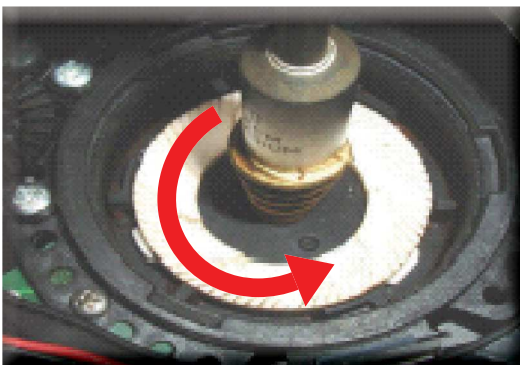

Turn the grinder blades anticlockwise out of the support.

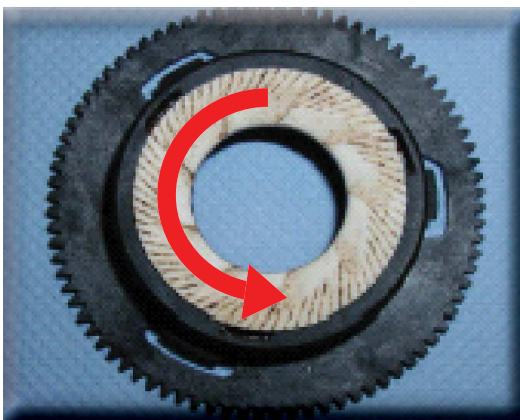

Turn the grinder blades clockwise out of the support. The bayonet connections can be accessed from the rear.

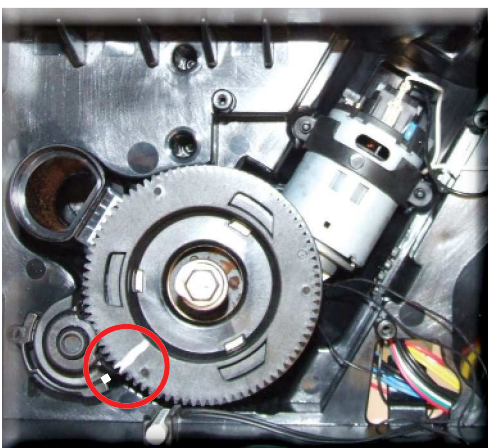

For a standard adjustment, both markings must be aligned.



### 7.4. Coffee grinder adjustment

The grinding adjustment can be set by the user (only with the coffee grinder in operation) by pressing and turning (only by one click at a time) the knob inside the coffee bean hopper

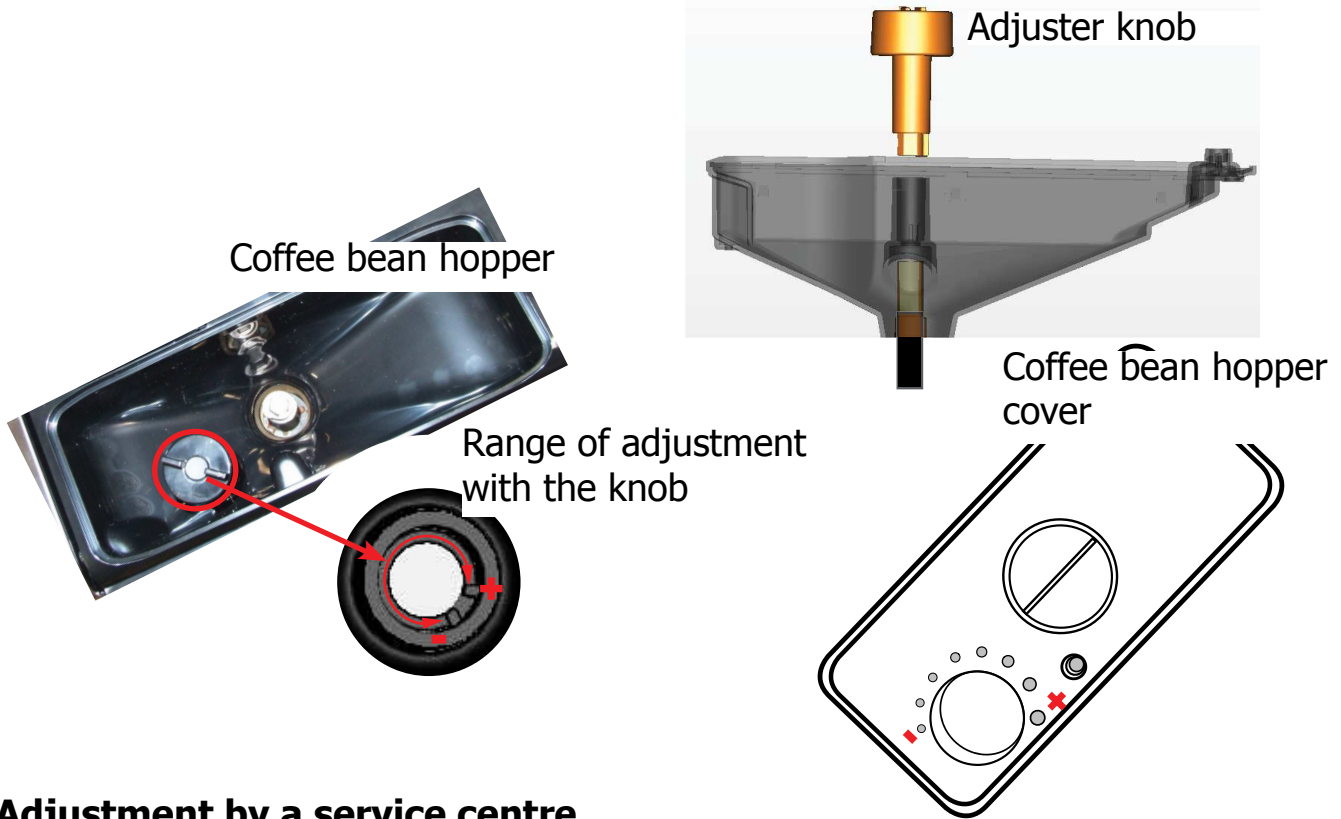

### Adjustment by a service centre

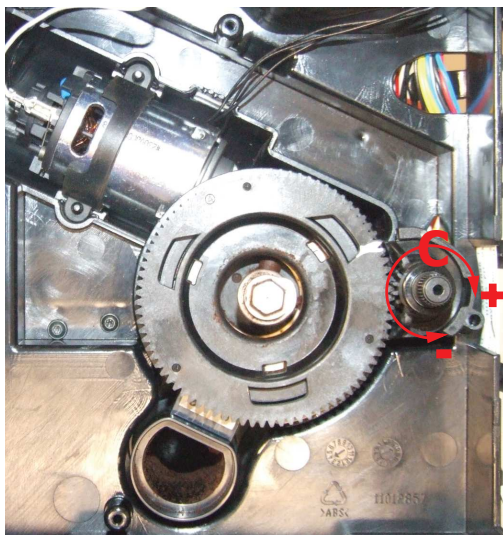

To adjust grinding further, the engineer can work directly on the coffee grinder by pressing and turning the ring nut (C) shown. (clockwise + to increase the particle size of the coffee and anticlockwise - to decrease it).

If there are any remains of coffee powder between the two grinding blades it is recommended to tighten by max. two marks at a time.

Lastly, move the arrow (A) on the adjustment knob to the centre of the adjustment dots on the cover (B).

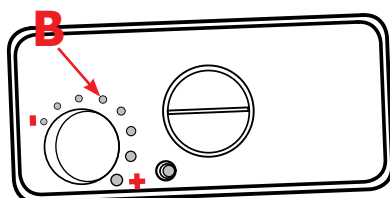

**7.5. Steam pump**

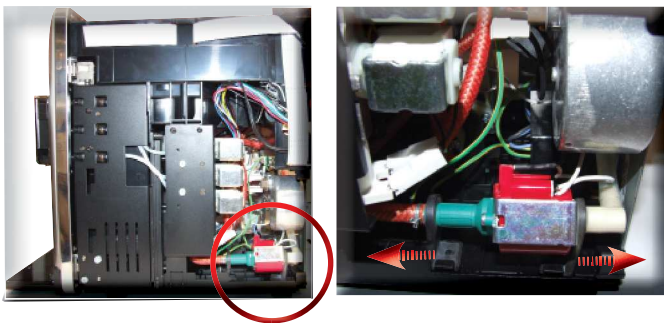

Slide out the two pump supports (highlighted) fixed to the housing and disconnect the electrical and water circuit connections

**7.6. Coffee pump**

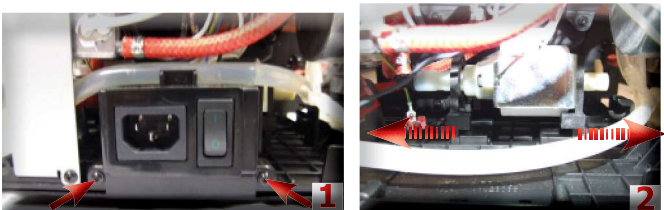

1) Loosen the screws as illustrated and remove all electrical connections from the component support  
2) Extract the pump from the supports and disconnect it from the electrical and water circuit connections

**7.7. Turbine**

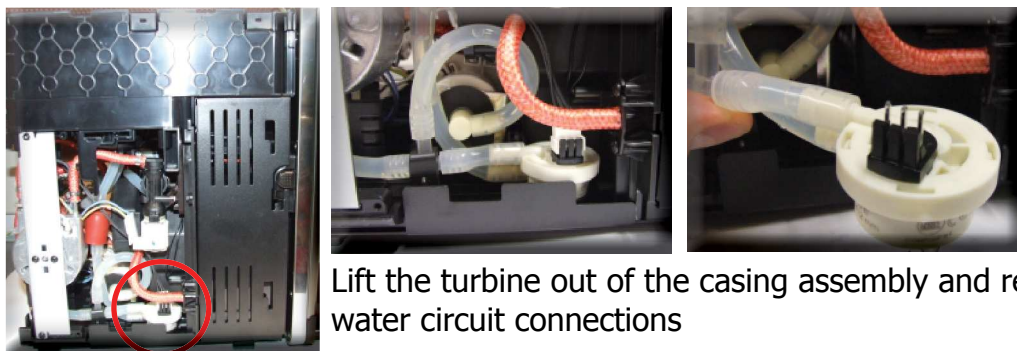

Lift the turbine out of the casing assembly and remove the electrical and water circuit connections

**7.8. Power card**

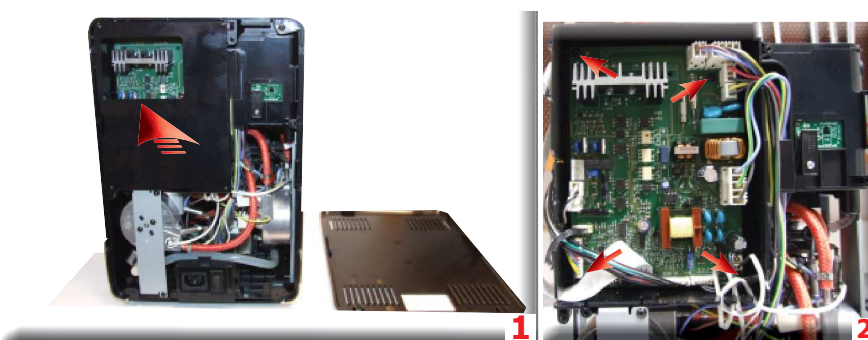

1) Remove the card cover by raising it  
2) Loosen the screws as illustrated and remove the PWR card extracting the electrical connections

**7.9. Steam boiler**

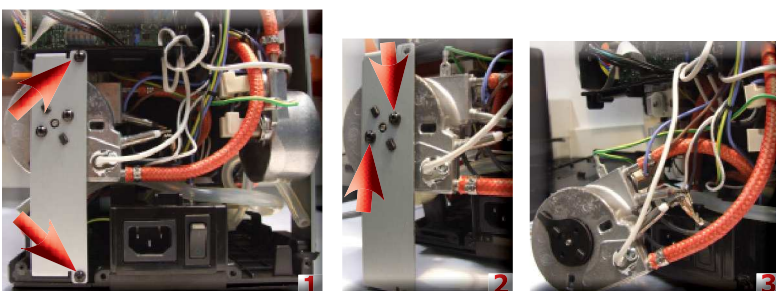

1-2) Unscrew the screws shown  
3) Unhook the boiler, disconnect the electrical and water circuit connections



**7.10. Coffee boiler**

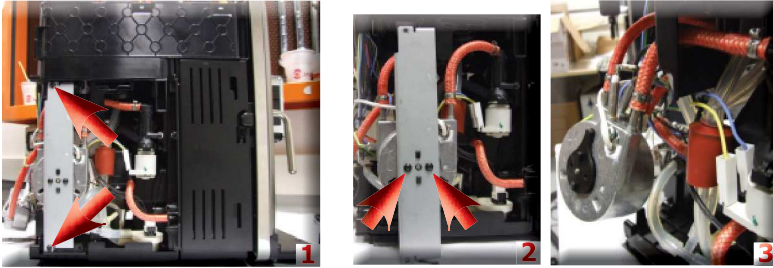

1-2) Unscrew the screws shown  
 3) Unhook the boiler, disconnect the electrical and water circuit connections

**7.11. Gearmotor:**

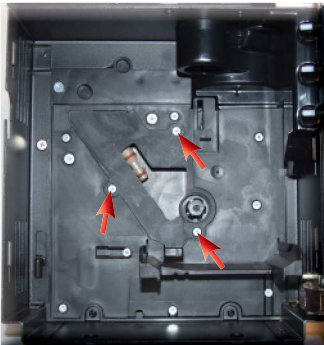

Loosen the screws as illustrated and remove the boiler pin

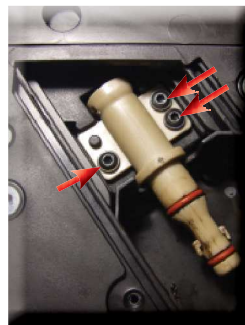

Loosen the screws as illustrated and remove the boiler pin

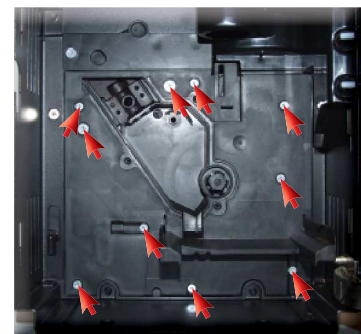

Loosen the screws as illustrated and remove the gearmotor cover

The following are located inside the compartment protected by the casing:

- Electric motor (A) with gears (B) and (C) for transmission and timing of the dispensing unit
- Dreg drawer presence sensor (D)
- Dispensing head present microswitch (E)
- Microswitch (F) detecting brewing unit home and work positions
- Remove the gear (C) that meshes with the motor transmission shaft
- Remove the large gear (B)
- Remove the motor (A), complete with transmission shaft

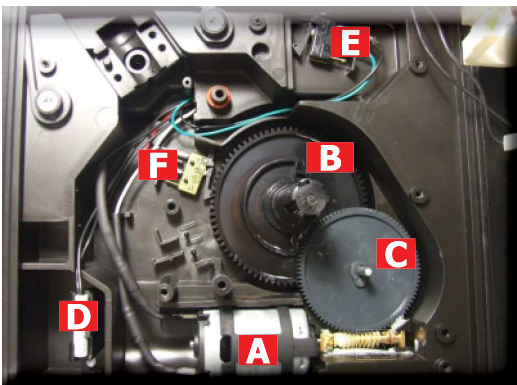

- (G) Multi-way valve drain

Replace the gear (B), making sure that the imprint of the arrow is aligned with the opening containing the pin (P).

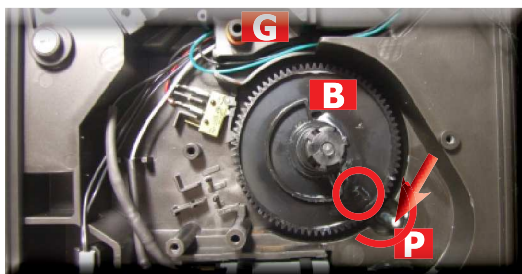

When replacing the motor and the transmission shaft, make sure the guide runners (L) are in the right position. Grease the shaft thoroughly and evenly.



**7.1. Multi-way valve**

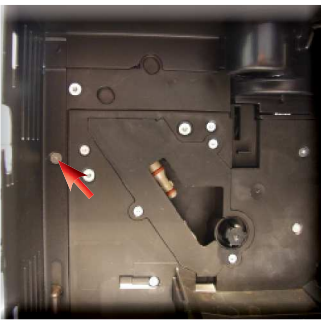

Unscrew the screws as indicated to reach the screw anchoring the multi-way valve to the support

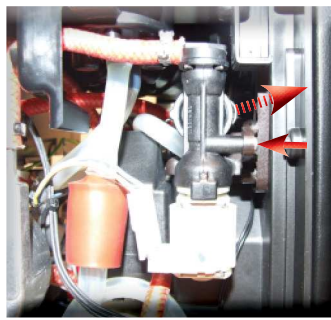

Loosen the screw as illustrated and remove the clip



Disconnect the electrical and water circuit connections

**7.13. Frother unit valve assembly**



Unscrew the screws anchoring the valve support to the housing and to the horizontal plate as shown

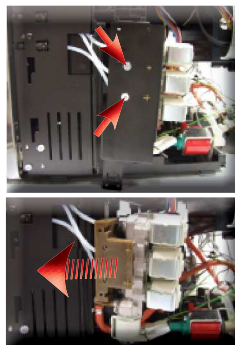

Unscrew the screws shown and pull out the valve assembly

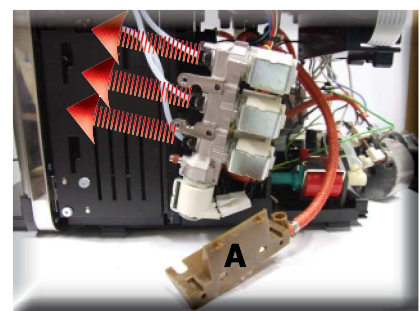

Unhook the support for coupling the drain (A) and extract the three Teflon tubes as shown

**7.14. Door tube coupling**

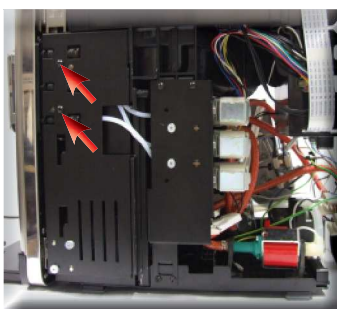

Loosen the screws as illustrated

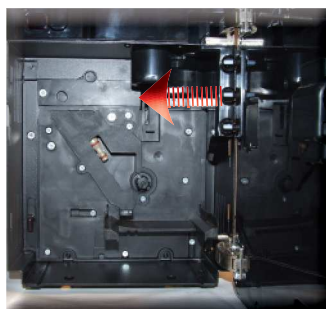

Extract the coupling guard

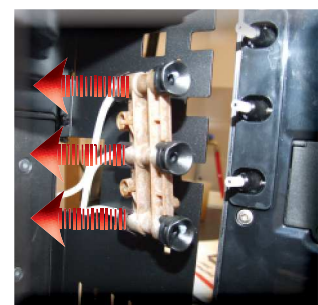

Unhook the coupling (A) and extract the three Teflon tubes as shown



### 7.15. Dispenser assembly



Extract the dispenser assembly



Loosen the screws as illustrated to remove the inner front panel cover



Loosen the screws located inside the door and slide out the coffee dispenser as shown

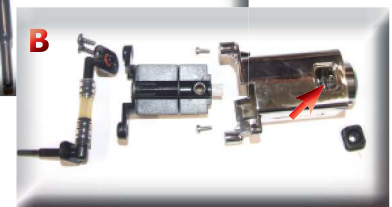
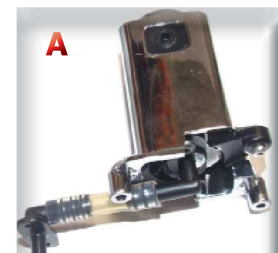

Remove the dispenser (photo B); when replacing it, make sure the spring highlighted is positioned correctly

### 7.16. Steam pipe assembly



Loosen the screws as illustrated to remove the inner front panel cover

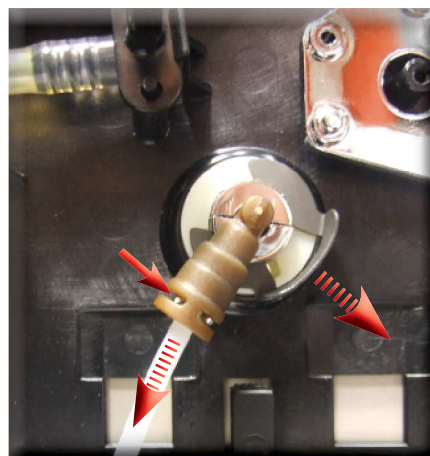

Remove the fork spring and the steam pipe washer, disconnect the pipe from the Teflon by removing the fork



**7.17. General carafe card assembly**

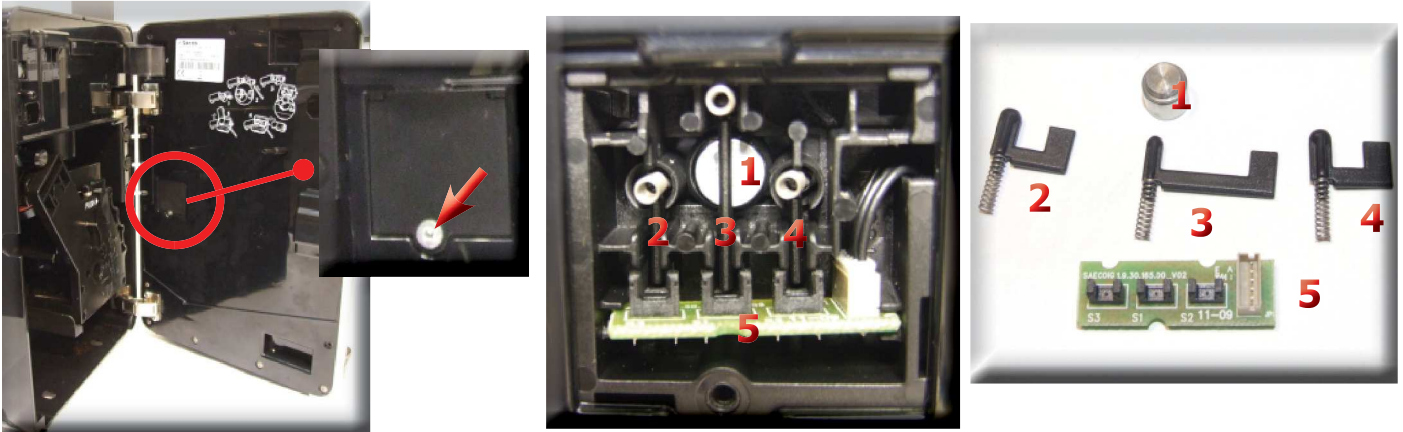

Loosen the screw as shown

- 1) Magnet to improve carafe adherence to the door
- 2,3,4) for the carafe presence and position sensors
- 5) Carafe card

**7.18 Teflon pipe support and carafe attachment assembly**



Loosen the screws as illustrated to remove the inner front panel cover

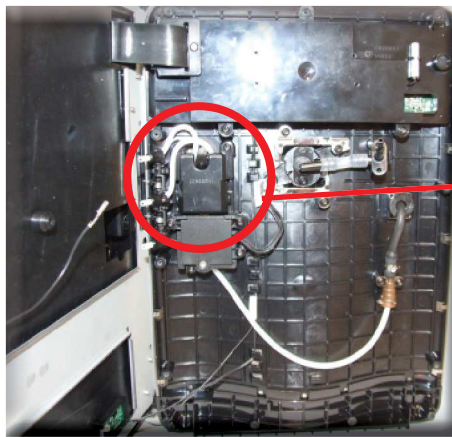

Remove the screws shown and pull the Teflon pipe support cover away from the carafe

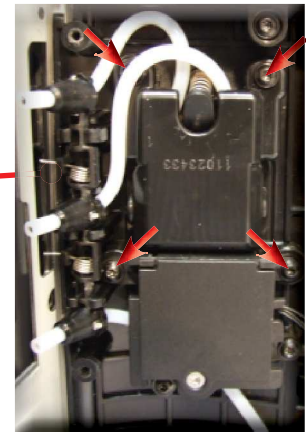

Remove the Teflon pipe support assembly

**7.19. CPU and display card**

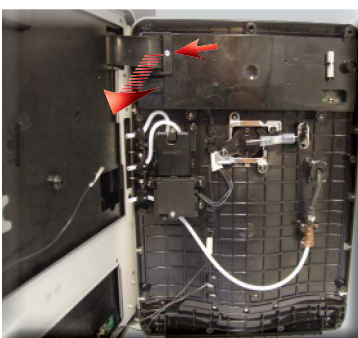

Loosen the screws as illustrated and remove the guard and the flat cable



Unscrew the screws of the display support as shown





Extract the connections and flat cable.



Extract the display and the keypad



CPU and display card assembly

**7.20. Fitting and removing Oetiker clamps**

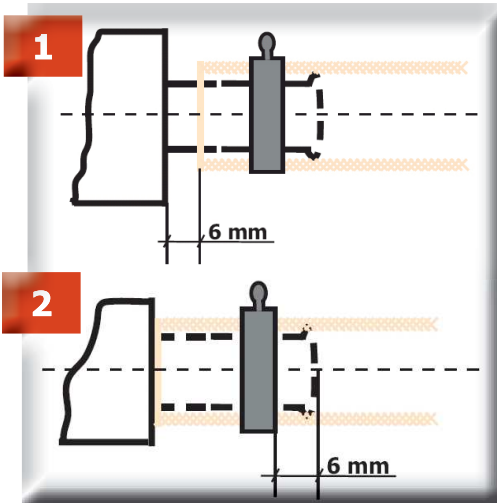

1) Boiler connection

2) Other connections

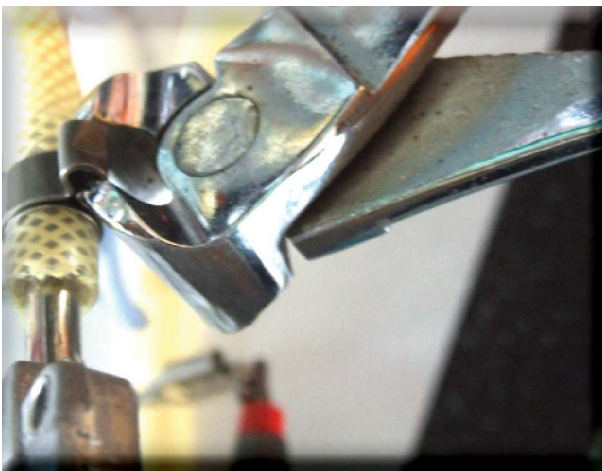

Use a suitable pair of pliers to remove the clamp (as illustrated)



Tighten the clamp as illustrated



# CHAPTER 8

## NOTES







# CHAPTER 9

# WATER CIRCUIT DIAGRAM

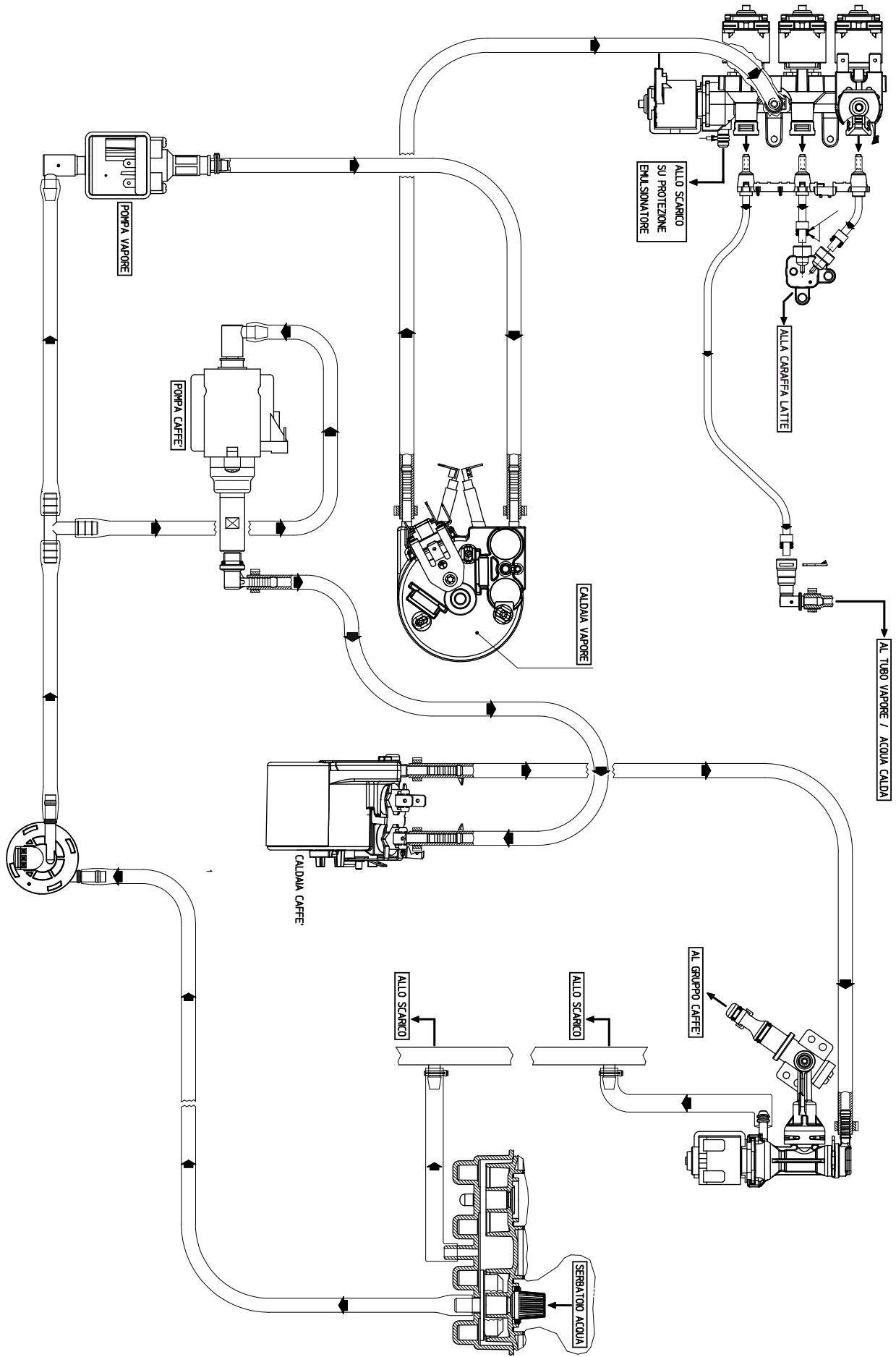



# CHAPTER 10

# ELECTRICAL DIAGRAM

