

# Service Service Service

## Exprelia Evo and Evo2



# Service Manual

Rev. 00 September 2015

### TECHNICAL INFORMATION

Power supply and output:	240 V~ 50 Hz 1900W - 230 V~ 50/60 Hz 1900 W 120 V~ 60 Hz 1300 W
Temperature monitoring:	(NTC) variable resistor sensor - transmits the value to the electronic card
Safety system:	2 thermostats at 190°C one shot
Coffee heat exchanger output: Stainless steel for coffee, hot water and steam dispensing	(230 V~) 1900 W - (120 V~) 1300 W - (100 V~) 1100 W
Dimensions: W x H x D in mm:	245 x 360 x 420 mm (data may vary depending on the model)
Stand-by power consumption	< 0,5W
Weight:	13.4 kg (data may vary depending on the model)
Water tank capacity:	1.5 l
Coffee bean hopper capacity:	300 g. of coffee beans
Dreg drawer capacity:	1l
Heating time:	Approx. 45 sec.
Water circuit filling time:	Approx. 15 sec Max. on first filling cycle
Power consumption:	During heating phase- approx. 5.6 A
Automatic dosage:	Dose adjustment controlled by the electronic system
<b>Material</b>	
Housing	ABS/ABS+PMMA/METAL
Beans container	ABS
Water tank	SAN
Dreg drawer	ABS

All parts of this document are the property of Saeco International Group.

All rights reserved. This document and all the information herein is provided without liability deriving from any errors or omissions. Furthermore, no part may be reproduced, used or collected, except where express authorisation has been provided in writing or through a contractual agreement.

# Exprelia Evo

Table of contents		Page	Table of contents		Page
<b>1.</b>	<b>Introduction</b>		<b>6.</b>	<b>Standard checks</b>	
1.1.	Documentation required	1	6.1.	Repair Flow	1
1.2.	Tools and equipment required	1			
1.3.	Material	1	<b>7.</b>	<b>Disassembly</b>	
1.4.	Safety warnings	1	7.1.	Outer elements	1
1.5.	Service Policy	2	7.2.	Coffee grinder	2
1.6.1.	External machine parts Exprelia Evo - Evo2	3	7.3.	Grinder blades	3
1.6.2.	Internal machine parts	5	7.4.	Coffee grinder adjustment	4
			7.5.	Steam pump	5
<b>2.</b>	<b>Technical specifications</b>		7.6.	Coffee pump	5
2.1.	Technical specifications	1	7.7.	Flow meter	5
2.2.	Machine parameters and performance	1	7.8.	Power Board	6
2.3.1.	Specification for the measurement of the milk products temperature	4	7.9.	Steam boiler	6
2.3.2.	Specification for the measurement of the Milk products temperature.	5	7.10.	Coffee boiler	6
			7.11.	Gearmotor	7
<b>3.</b>	<b>User instructions</b>		7.12.	Frother valve assembly	8
3.1.	Customer and programming menu Exprelia Evo	1	7.13.	Dispenser assembly	8
3.2.	Customer and programming menu Exprelia Evo V2	5	7.14.	CPU Water level Sensor	8
			7.15.	Steam pipe assembly	9
<b>4.</b>	<b>Operating logic</b>		7.16.	Teflon pipe support and carafe fitting assembly	9
4.1.	Water circuit	1	7.17.	Carafe board general assembly	10
4.2.	Frother valve assembly	2	7.18.	CPU board, display and front panel	10
4.3.	General carafe assembly	2	7.19.	Un/installing Oetiker clamps	11
4.4.	Multi-way valve	4			
4.5.	Coffee cycle	5	<b>8.</b>	<b>Notes</b>	
4.6.	Single microswitch	5			
4.7.	Temperature sensor (adjustment)	6	<b>9.</b>	<b>Water circuit diagram</b>	
4.8.	Coffee grinder	7			
4.9.	Detection of coffee bean absence, dose adjustment, blocked coffee grinder	7	<b>10</b>	<b>Electrical diagram</b>	
4.10.	Auto-learning dose (SAS)	8			
4.11.	SBS	9			
4.12.	Water level detection in the tank	10			
4.13.	Drip tray water level detection	10			
4.14.	Descaling request in Exprelia Evo	11			
4.15.	Anti-scale filter in Exprelia Evo	11			
4.16.	AquaClean water filter Exprelia Evo V2	12			
<b>5.</b>	<b>Troubleshooting</b>				
5.1.	Test mode Exprelia Evo V2	1			
5.2.	SteamOut	7			
5.3.	Diagnostics mode EVO 2	8			
5.4.	Test mode Exprelia Evo	13			
5.5.	Steam-out	19			
5.6.	Diagnostics mode Evo	20			

## What's new / Important Exprelia Evo2

Boiler	Boiler increased for greater water passage
Water container	New Water container for housing new filter
AquaClean water filter	New filter (see description point 4.10.)
Brew Unit	New Brew Unit with yellow components (The productions of October)

# **CHAPTER 1**

## **INTRODUCTION**

### 1.1 Documentation required

The following documentation is needed for repair procedures:

- Instruction booklet for specific model
- Technical documentation for specific model (diagrams, exploded view, symptom cure and service manual)

### 1.2 Tools and equipment required

As well as the standard equipment, the following is required:

Qty.	Description	Notes
1	Screwdriver	
1	Pliers for Oetiker clamps	
1	CC -A - Vdc tester	
1	Digital thermometer	Scale limit > 150°C
1	SSC (Saeco Service Center)	Programmer (for programming and diagnostics mode)

### 1.3 Material

Description	Notes
Thermal paste	Heating element > 200°C
Descaler	Saeco descaler
Grease solvent	Personal choice
Silicone grease	Safe to use with food

### 1.4 Safety warnings

We recommend you consult the technical manual of the machine before performing any maintenance work.

Observe all applicable standards relating to the repair of electrical appliances.

Always disconnect the power plug from the mains before beginning repair work.



Simply turning off the main machine power switch is not an adequate safety precaution.

This domestic appliance is rated as insulation class I.

On completion of the repair work, insulation and dielectric rigidity tests must be performed.



Disassembling the machine, the operator must pay attention to hot and under Pressure parts: boiler, pin-boiler, valves, dispensing, steam tube, brew unit, connections and pipes to avoid burns. Please refer to specific hydraulic circuit (Image1) to know the parts in detail.



The machine hydraulic circuit can reach maximum pressure of 16/18 bar.

To operate in safety condition is recommended to perform the Steam Out procedure in order to remove the pressure and hot water inside the hydraulic circuit.



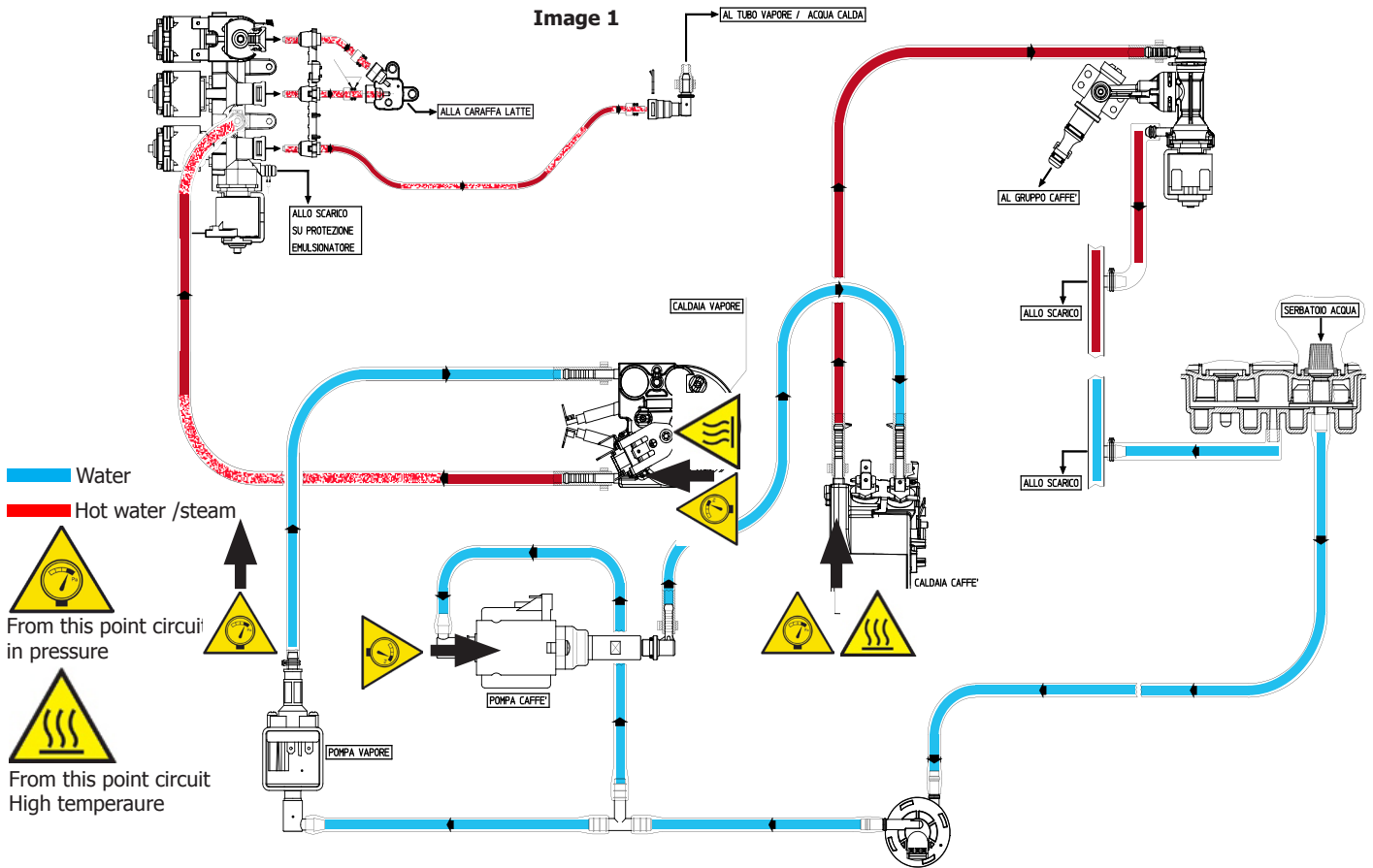

### 1.5 Service POLICY grid as used for coffee machine

**For IN WARRANTY** repairs is mandatory to use the single components (not the assembly) available in the exploded views of the coffee machines or of the specific components. If you find the information "SEE THE EXPLODED VIEW E....." in the assembly description field, it means that the single components of the assembly are available in the other pages of the exploded view. It's possible to use the assembly only if there is a specific Symptom Cure that include this possibility or when the single components are not available for the order.

### List of principal assembly present in all our coffee machines

Components	Assembly use	Single components available
<b>COFFEE GRINDER</b>	<u>Only for OOW repairs</u>	<b>YES</b> , to consult the specific exploded-view of the machine or of the Coffee Grinder on website
<b>BREWING UNIT</b>	<u>Only for OOW repairs</u>	<b>YES</b> , to consult the specific exploded-view of the machine or of the Brewing unit on website
<b>BOILER</b>	<u>Only for OOW repairs</u>	<b>YES</b> , to consult the specific exploded-view of the machine on website
<b>GEAR MOTOR</b>	<u>Only for OOW repairs</u>	<b>YES</b> , to consult the specific exploded-view of the machine on website
<b>FILTER HOLDER</b>	<u>Only for OOW repairs</u>	<b>YES</b> , to consult the specific exploded-view of the machine on website
<b>MILK CARAFE</b>	<u>Only for OOW repairs</u>	<b>YES</b> , to consult the specific exploded-view of the machine on website
<b>THERMAL CARAFE</b>	<u>Only for OOW repairs</u>	<b>YES</b> , to consult the specific exploded-view of the Thermal Carafe on website
<b>MILK ISLAND</b>	<u>Only for OOW repairs</u>	<b>YES</b> , to consult the specific exploded-view of the Milk Island on website

1.6.1 External machine parts Exprelia Evo Evo2

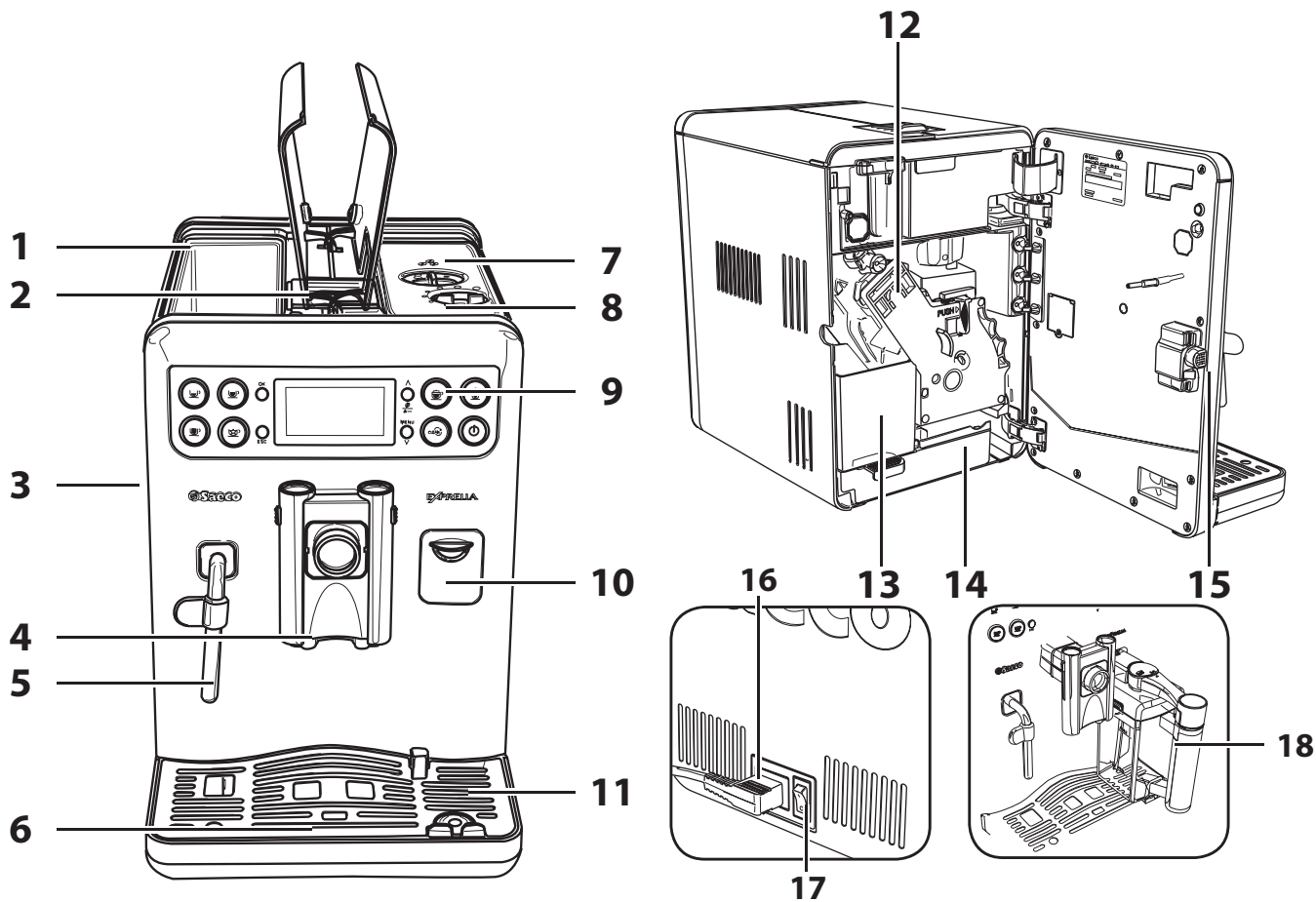

01	Water tank	10	Carafe coupling cap
02	Pre-ground coffee compartment	11	Drip tray (external)
03	Service door	12	Brew group
04	Dispensing spout	13	Coffee grounds drawer
05	Hot water/steam wand	14	Drip tray (internal)
06	Full drip tray indicator	15	Service door button
07	Coffee bean hopper with lid	16	Power cord socket
08	Grinder adjustment	17	Power button
09	Control panel	18	Milk carafe

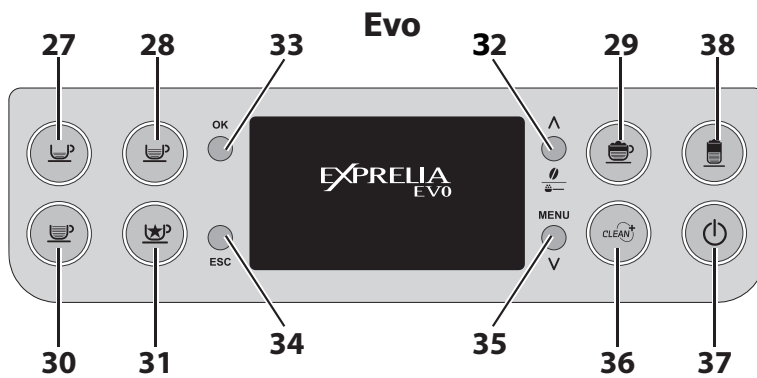

27	Espresso button
28	Coffee button
29	Cappuccino button
30	Long Coffee button
31	"Special beverage" button
32	"Aroma" - Pre-ground coffee button
33	"OK" button
34	"ESC" button
35	"MENU" button
36	Carafe cleaning cycle activation button (Clean)
37	Stand-by button
38	Latte macchiato button

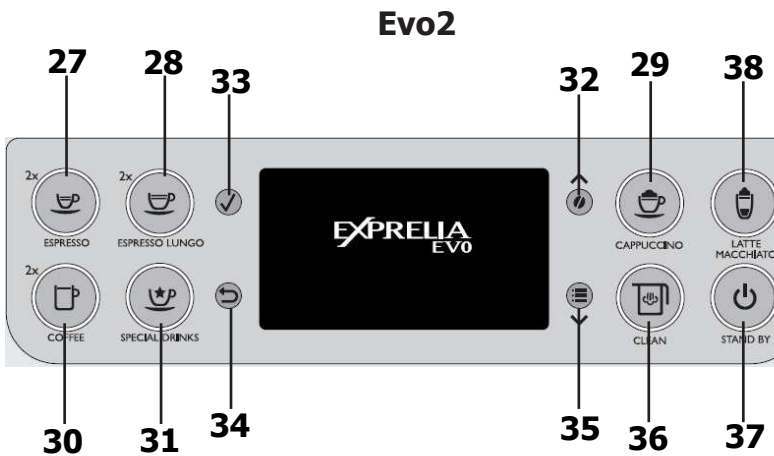

27	Espresso button
28	Espresso Long button
29	Cappuccino button
30	Coffee button
31	"Special Drink" button
32	"Aroma" - Pre-ground coffee button
33	"OK" button
34	"ESC" button
35	"MENU" button
36	Carafe cleaning cycle activation button (Clean)
37	Stand-by button
38	Latte macchiato button

1.6.2 Internal machine parts

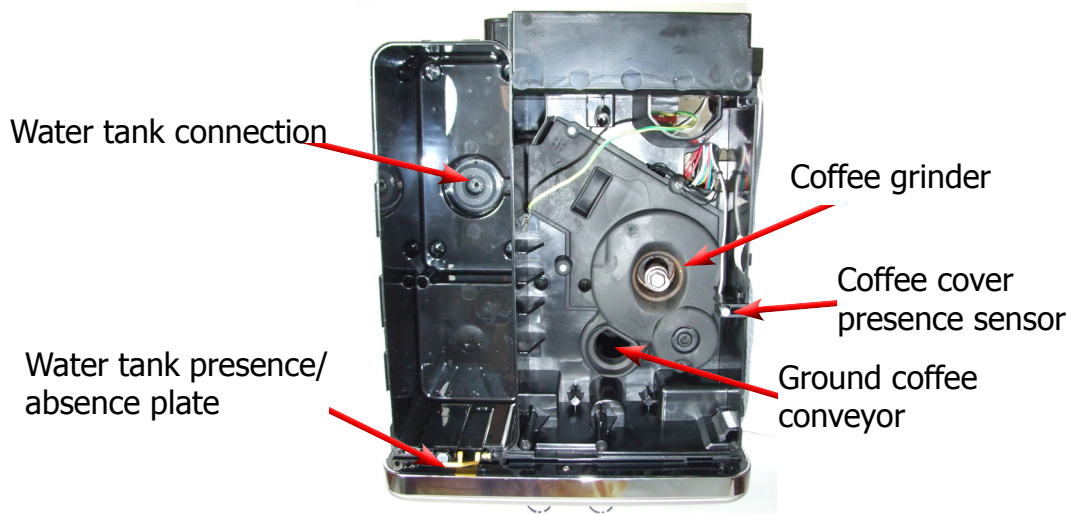
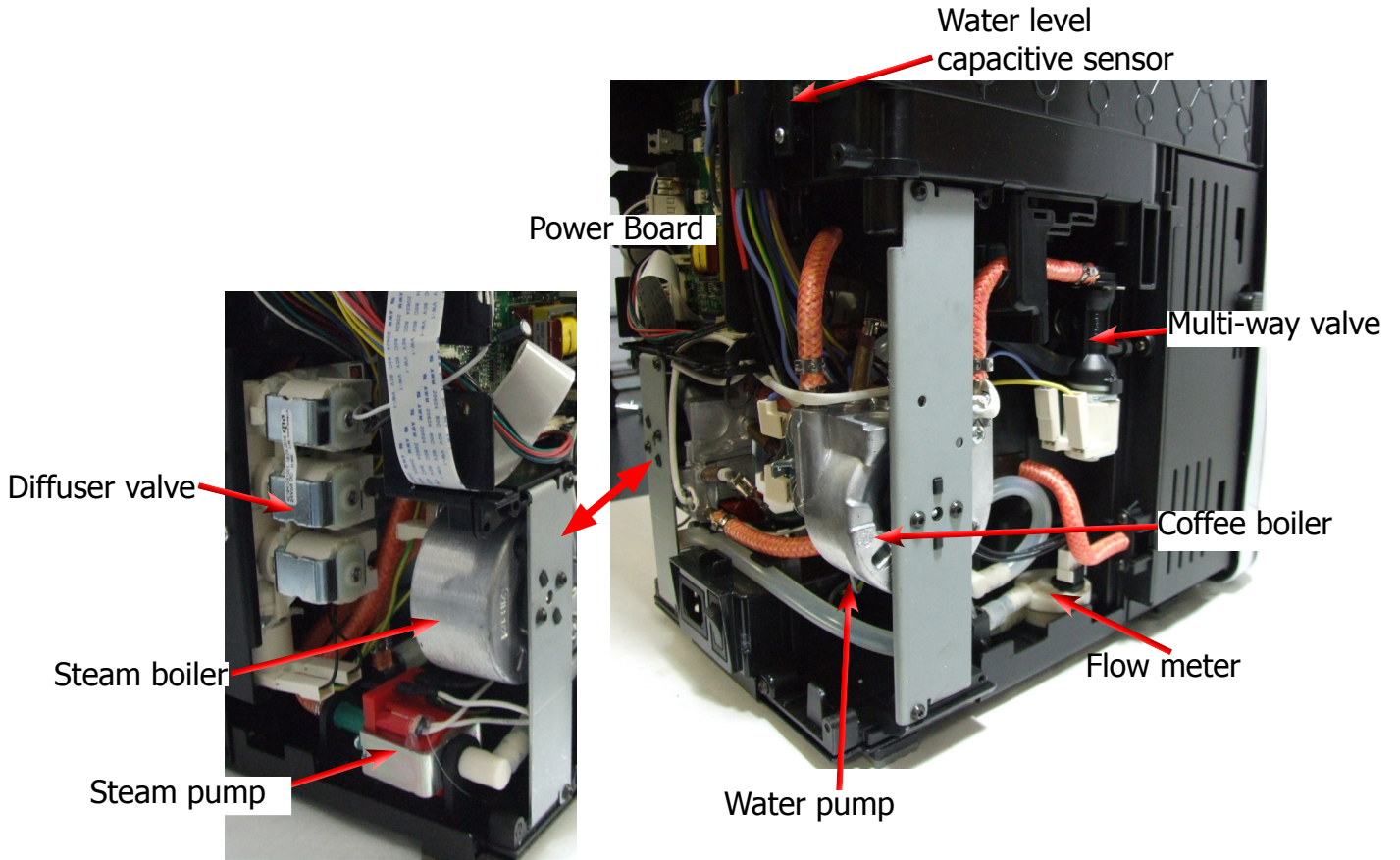

# **CHAPTER 2**

# **TECHNICAL SPECIFICATIONS**

**2.1. Technical specifications**

Power supply and output:	240 V~ 50 Hz 1400 W - 230 V~ 50/60 Hz 1400 W - 120 V~ 60 Hz 1500 W - 100 V~ 50/60 Hz 1300 W
Temperature monitoring:	Variable resistor sensors (NTC) transmits the value to the control board
Safety system:	2 manual reset or one-shot thermostats (175°C)
Coffee heat exchanger output: Stainless steel	(230/120 V~) 1300 W – (100 V~) 1100 W to dispense coffee, hot water and steam
Steam heat exchanger output: Stainless steel	As above
Gearmotor:	2 rotation directions; 24VC power supply
Coffee pump	Ulka Type EP5/S GW approx. 13-15 bar with reciprocating piston and 120°C cutout 48 W, 230V, 50 Hz, 120V, 60Hz 100V, 50/60 Hz
Steam pump	Ulka MF with reciprocating piston 230V, 50 Hz, 120V, 60Hz 100V 50/60 Hz
Overpressure valve: (multi-way valve)	Opening at approx. 17-23 bar
Water filter:	In tank
Coffee grinder:	Direct current motor with flat ceramic grinder blades
Automatic dosage	Dose adjustment controlled by the electronic system
Consumption:	During the heating phase - approx. 5.6 A
Consumption in Stand-by	< 1 W
Dimensions: W x H x D in mm:	245x360x420 (data may vary depending on the model)
Weight:	13.4 kg (data may vary depending on the model)
Water tank capacity:	1.5 l.
Coffee container capacity	300 g coffee beans
Dreg drawer capacity	11
Heat exchanger capacity:	Approx. 10 cc
Water circuit filling time:	Approx. 15 sec. max on first filling cycle
Heating time:	Approx. 45 sec.
Grinding time:	Approx. 8-10 sec.

**2.2. Machine parameters and performance**

<b>PRODUCT QUANTITY</b>	<b>Min quantity (Puls.)</b>	<b>Max quantity (Puls.)</b>	<b>Max quantity (Puls.)</b>	<b>Set by the user</b>	<b>Set by the Production/Service Dept</b>
<b>Espresso</b>	50	130 - 170 *	600	Yes	No
<b>Espresso lungo</b>	70	200 - 230 *	600	Yes	No
<b>Pre-ground</b>	Yes				
<b>Hot water</b>	Continues for 400 pulses				
<b>Steam nozzle</b>	Continues until the water is used up (capacitive sensor)				

\* Depends on the language selected by the user



<b>RINSE</b>	<b>Initial rinse</b>	<b>Final rinse</b>
When performed	When the machine is switched on and the temperature of the boiler reaches $\leq 50^{\circ}\text{C}$	When the machine is switched off electronically, manually or automatically after 60', if at least one coffee has been dispensed before being switched off
No. of Pulses	130	100
Stop option	Yes, by pressing any key	Yes, by pressing any key
Can be disabled by the user	Yes	No
Can be disabled by the Production/Service Dept	No	No
No. of pulses adjustable by the user	No	No
No. of pulses adjustable by the Production/Service Dept	No	No
Pulse range (Min - Max)	No	No

<b>STAND-BY</b>	<b>Description and values</b>
<b>Input time (min - max)</b>	15 minutes - 180 minutes
<b>Input time (default)</b>	15 minutes
<b>Input time set by user</b>	Yes
<b>Input time set by the Production/Service Dept</b>	Yes
<b>Boiler temperature during Stand-by</b>	Boiler OFF
<b>Cup heater during stand-by</b>	Cup heater OFF
<b>Timer and Stand-by</b>	Yes **

**\*\* The machine switches on at the TimerOn (Timer) value and switches off when the "Stand-by input time" (Delay - Time) has elapsed**

<b>DREG DRAWER</b>	<b>Description and values</b>
<b>Time-out for dreg drawer</b>	5 sec.
<b>Warning to empty dreg drawer</b>	Yes, after 12 lots of dregs
<b>Empty dreg drawer block alarm (double espresso as the last dispensed product)</b>	15 lots of dregs (16 lots of dregs)
<b>Reset dreg counter</b>	Only if the Warning or the empty dreg drawer alarm is triggered and the dreg drawer is removed for at least 5 seconds.

WATER TANK	Description
Water reserve (pulses) with water filter	200
Water reserve (pulses) with no water filter	200
Water reserve modifiable by the Production/Service Dept	No
"Fill tank" alarm	Yes
"No tray" alarm	No
Water mains	No

**Descaling frequency (Intenza) in Expreflia Evo**

Hardness	Water hardness	Without anti-scale filter	With anti-scale filter
1	Soft (up to 7°dH)	240 litres (480,000 pulses)	480 litres (960,000 pulses)
2	Medium (7° - 14°dH)	120 litres (240,000 pulses)	240 litres (480,000 pulses)
3	Hard (15° - 21°dH)	60 litres (120,000 pulses)	120 litres (240,000 pulses)
4	Very hard (over 21°dH)	30 litres (60,000 pulses)	60 litres (120,000 pulses)

The default water hardness level is 3. Each litre of water corresponds to approximately 2,000 pulses

**Descaling frequency in AQUACLEAN Expreflia Evo V2**

The first activation must be made before you've paid up to 5000ml products because mind thinks as if he had the filter

Hardness	Filter number	Percentual on display 10% the icon flashes slowly.	Percentual on display 0% the icon flashes quickly.	MAX Quantity water, the icon turns off. (replace filter)	
Indifferent	From 1/8 to 7/8	8050ml	2000ml	62500ml	Replace filter (you can not turn off)
	8/8				Descaling

**If after descaling or after the use of a filter this is not reactivated , the machine recognizes the water hardness setting and calculates as in the table below**

**Descaling cycle frequency**

Hardness	WATER HARDNESS	Without water filter	Not reactivating the filter
1	Soft (up to 7°dH)	240 litres (480,000 pulses)	210 litres (420,000 pulses)
2	Medium (7° - 14°dH)	120 litres (240,000 pulses)	105 litres (210,000 pulses)
3	Hard (15° - 21°dH)	60 litres (120,000 pulses)	52.5 litres (105,000 pulses)
4	Very hard (over 21°dH)	30 litres (60,000 pulses)	26.25 litres (52,500 pulses)

The default water hardness level is 4. Each litre of water corresponds to approximately 2,000 pulses.



**2.3.1. Specification for the measurement of the coffee products temperature.**

The temperature is influenced by the flow from the dispenser and stratification of temperatures in the glass. In order to consider these phenomena and to introduce measures that allow comparisons in controlled conditions, below guidelines must be followed:

**Conditions:**

- a) Water temperature in tank: 23°C (+/-2°C).
- b) It must be used a plastic cup (see picture N°1).
- c) It must be used a thermocouple thermometer (e.g. type K - see picture N°2).
- d) The coffee machine is tested without any change of parameters or calibrations, which may affect the temperature of products, so the measurement of temperature must be done with machine in default factory setting.

**Procedure:**

1. The temperature must be measured in the cup, immediately after dispensing. Cup has to be placed on a non-metal surface using a thermocouple thermometer (Picture 1).
2. The temperature in the cup is measured by immersing the probe of the thermometer up to touch the bottom. The probe then must be moved in a circular motion for 5/6 rotations. At the of the rotations, stop in the center of the cup (Picture 2).
3. The highest temperature measured during the rotations is the value we are searching for, and that must be reported;
4. Test measurement: from end of dispensing to the end of rotations must be completed within 12 seconds.
5. the distance of the probe from the bottom of the glass is a function of the quantity of coffee dispensed: 10mm for 35gr - 17mm for 60gr - 35mm for 120gr and superior (Picture 3).

**Limits of acceptability**

The acceptance limits are divided by features and products and are the following:

**Espresso Coffee Italy Q.ty 25/40 gr.**

Temperature of 1st product 69°C ≤ 85°C  
 Temperature of 2nd product 72°C ≤ 85°C

**Coffee Q.ty 70/120 gr.**

Temperature of 1st product 69°C ≤ 85°C  
 Temperature of 2nd product 72°C ≤ 85°C

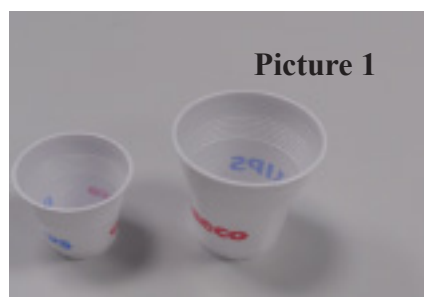

Picture 1



Picture 2

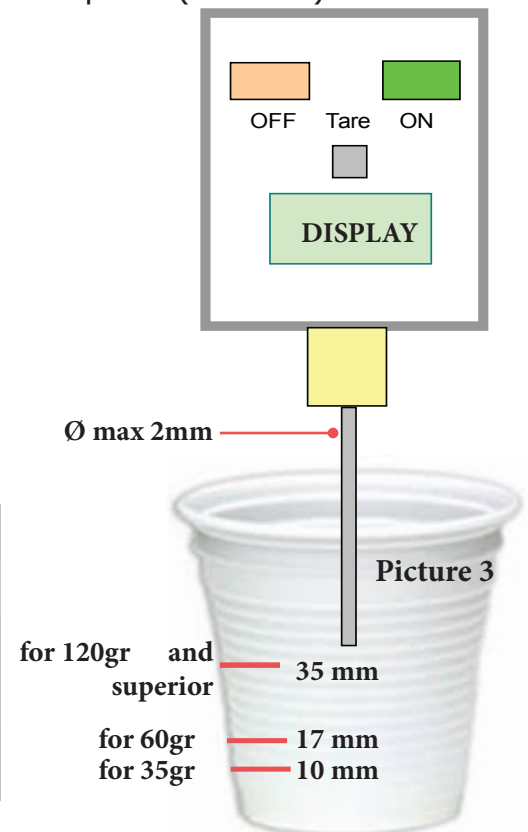

### 2.3.2. Specification for the measurement of the Milk products temperature.

#### Milk evaluation

To carry out the test, a partially skimmed UHT milk with a percentage of grease between 1.5-1.8% at a refrigerator temperature  $T_{refr}$ . (between 4 to 10°C) must be used.

The milk product must be checked on a beaker of 250 ml of capability and with an inner diameter of 70mm, brewing 100gr of product.

#### Parameters to be respected:

The parameters to be respected are: milk temperature and height of the cream. Each of these parameters, however, must be evaluated depending on the type of system used for the production of hot milk. Actually three types of devices are present on the appliances:

- Manual system (pannarello)
- Semi-Automatic system (cappuccinatore)
- Automatic system (carafe, Pinless wonder system, etc.)

#### Milk temperature in the beaker:

System without Pinless Wonder: With milk at  $T_{refr}$ . (about 4-10 °C):  $\rightarrow \Delta \geq 36$

how does it work:

1. The cold milk is frothed with air in the first chamber.
2. Then, the frothed milk is heated in the second chamber thanks to the steam.

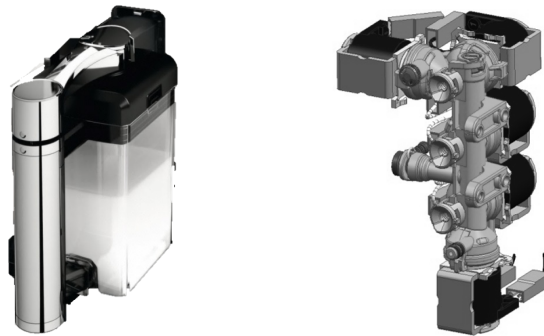

#### Height of the milk cream in the beaker:

Manual system (pannarello)  $\geq 15\text{mm}$  on 100gr. of brewed product

Semi-automatic system (cappuccinatore)  $\geq 20\text{mm}$  on 100gr. of brewed product

Automatic system: carafe, cappuccinatore, Pinless wonder e.g. (New Royal, Energica Pure, Intelia EVO latte)  $\geq 20\text{mm}$  on 100gr. of brewed product

#### How to measure the temperature of the milk.

1. The measurement is carried out in the beaker, immediately after the end of milk brew, positioned on a non-metallic surface, using a thermocouple thermometer (eg. Type K). Stop the preparation of mixed product: at the end of milk brewing, where "One Touch product" function is present.
2. The temperature is measured by immersing the probe of the thermometer, positioning the probe inside the beaker at about 10mm from the bottom of the container, then the probe moves in a circular motion for 3-5 turns, stopping at the end, at the center of the beaker. It detects the maximum temperature reached in a time of relief between 3 to 5 seconds. It is important the mixing of milk before the measurement at 10mm from the bottom of the beaker. If the mixing is correct, temperature, for a few fractions of a second, during the measurement should not oscillate.

**How to measure the milk cream.**

The temperature (Trefr or Tamb) of the milk doesn't affect as much the test result on measuring the milk cream; by convection is assumed to always use milk at refrigerator temperature Trefr..

**Manual systems (Pannarello)**

Pour 100cc. of milk at Trefr. in a beaker of 250 ml of capacity and with a inner diameter of 70 mm; with machine in steam mode:

1. Open the steam knob to discharger water circuit for 4 sec, then close the knob.
2. Place the beaker with the frother dipped in milk, open the steam knob to maximum and start the chronometer.
3. After about 30 to 60 seconds, close the knob and check the result on milk.

**Semi-automatic systems (cappuccino)**

Pours milk at Trefr. in a container ; with the machine in steam mode:

1. Open the steam knob to discharge water circuit for 4 sec. then close the knob.
2. Insert the silicone tube in the milk container, placing a beaker of 250 ml capacity and with an inner diameter of 70 mm under the cappuccino maker and open the steam knob.
3. After having provided 100gr. of product, close the knob and check the result obtained on milk. Note: The same applies to machines which have a steam key on the user interface and a solenoid valve in place of the steam tap.

**Automatic: Carafe, Cappuccino Pinless wonder e.g.:(New Royal, Energica Pure, Intelia EVO Latte), etc..**

After setting the machine to delivery of 100gr. of product:

1. Launch the "hot milk" function.
2. Collect the product in a beaker with a 250ml of capacity and with an inner diameter of 70 mm, and verify the result obtained on milk. Carry out the test using milk at a Trefr..

In case the machine allows modify of the emulsion through the menu, use the machine with the emulsion set to the default value.

Related to the above testing procedure derives the following table of acceptability:

<b>Manual, Semi-Automatic and Automatic's Milk System</b>	
Grams of Product	Minimun Height of the milk cream
≥ 130	≥ 30mm
120	≥ 25mm
110	≥ 22mm
<b>100</b>	≥ 20mm
90	≥ 16mm
80	≥ 13mm
70	≥ 11mm

**NB:** To verify more accurately the height of the cream, a practical expedient dictated by experience is to add to the product just delivered a small amount of coffee. The addition of coffee immediately put in evidence the surface of separation between liquid and cream.

# **CHAPTER 3**

# **USER INSTRUCTIONS**

3.1. Customer and programming menu Exprelia Evo

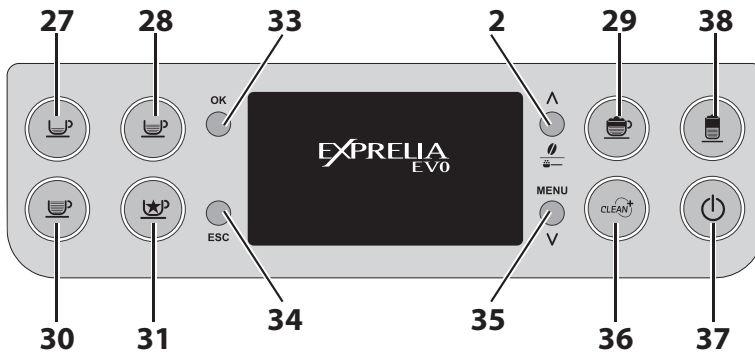

27	Espresso button
28	Coffee button
29	Cappuccino button
30	Long Coffee button
31	"Special beverage" button
32	"Aroma" - Pre-ground coffee button
33	"OK" button
34	"ESC" button
35	"MENU" button
36	Carafe cleaning cycle activation button (Clean)
37	Stand-by button
38	Latte macchiato button

General menu

- GENERAL MENU** The general menu allows you to change the operation settings.

  - TONE** The TONE function de-/activates the sound feedback.
  - ECOMODE** The ECOMODE enables you to save energy by limiting the boiler activation to one when the machine starts up. If you want to brew more milk beverages, the heating time may be longer. The function is set ON by default.
  - STAND-BY SETTINGS** The STAND-BY SETTINGS set the time interval for the machine when to go into stand-by mode after the last brewing. The stand-by time varies from 15, 30, 60 and 180 minutes. The default time value is 30 minutes.

Display menu

- DISPLAY MENU** The display menu allows you to set the language and the display brightness.

  - LANGUAGE** This setting is important to automatically adjust the parameters of the machine according to your country.
  - BRIGHTNESS**

**Water menu**

WATER MENU	The WATER MENU allows adjusting water parameters for optimal coffee.
HARDNESS	Under HARDNESS, you can set the level of water hardness. To measure water hardness, refer to chapter "MEASURING AND PROGRAMMING WATER HARDNESS"
ENABLE FILTER	By enabling the filter, the machine notifies the user when the water filter needs to be replaced. OFF: warning disabled. ON: warning enabled (the warning is automatically set when the filter is activated).
ACTIVATE FILTER	To activate the filter after its installation or replacement. Refer to the chapter "INTENZA+ Water Filter Installation".

**Maintenance menu**

MAINTENANCE	The MAINTENANCE MENU allows setting all the functions for correct machine maintenance.
COUNTERS	The COUNTERS function shows how many products have been brewed for every single type of coffee since the last reset.
BREW GROUP CLEAN	The BREW GROUP CLEAN function enables the monthly cleaning of the brew group (please see chapter "Monthly cleaning of the brew group").
CARAFE CLEANING	The CARAFE CLEANING function enables the monthly cleaning of the milk carafe (please see chapter "Monthly cleaning of the milk carafe").
DESCALING	The DESCALING function activates the descaling cycle (please see chapter "Descaling").
CARAFE CLEAN	The CARAFE CLEAN function activates the automatic self-cleaning of the milk carafe. The function is set ON by default.

**Factory Setting**

FACTORY SETTINGS	Activating the FACTORY SETTINGS will restore all machine settings to default values. In this case all the personal parameters will be lost.
------------------	---

## MEANING OF THE DISPLAY

## Help Message Displayed

## How to Reset the Message

CLOSE  
HOPPER DOOR

Close the bean hopper inner cover.

ADD COFFEE

Fill the coffee beans hopper.

INSERT BREW GROUP

The brew group must be inserted into the machine.

INSERT COFFEE  
GROUNDS DRAWER

Insert the coffee grounds drawer and the internal drip tray.

Empty the coffee grounds drawer.

EMPTY COFFEE  
GROUNDS DRAWER

**Note:**

The used grounds drawer must be emptied only when the machine requires it and with the machine on. If you empty the drawer with the machine turned off it will not record the emptying operation.

CLOSE  
FRONT DOOR

Close the service door.

REFILL  
WATER TANK

Remove the water tank and fill it.

Open the service door and empty the internal drip tray.

EMPTY DRIP TRAY

**Warning:**

If this operation is performed when the machine is on, it will record the used grounds drawer emptying and will reset the counter; therefore, it is necessary to empty the coffee grounds as well.

TURN CARAFE  
INTO  
BREWING POSITION  
←ESC

Open the milk dispenser of the carafe to brew products.  
Press the button "ESC" to exit.

TURN CARAFE  
INTO  
RINSING POSITION  
←ESC

Close the milk dispenser of the carafe to start the rinsing cycle of the carafe.  
Press the button "ESC" to exit.

## Help Message Displayed

## How to Reset the Message

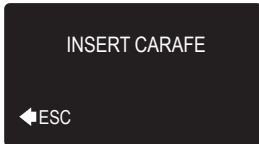

Close the bean hopper inner cover.



The machine needs to be descaled. Follow the steps described in the "Descaling" chapter of this manual. Please note that not descaling your machine will ultimately make it stop working properly. In this case repair is NOT covered under your warranty.



The machine needs the "INTENZA+" water filter to be replaced.



Red light flashes. Press the "⏻" button to exit the stand-by mode.

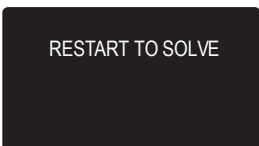

Take note of the code (E xx) shown in the display at the bottom. Turn off the machine. After 30 seconds, turn it on again. Try this 2 or 3 times. If the machine does not start, contact the Philips SAECO hotline in your country and tell them the code shown in the display. You can find its contact details in the warranty booklet by-packed separately or on [www.philips.com/support](http://www.philips.com/support).



### 3.2. Customer and programming menu Exprelia Evo V2

#### Menu for customization and maintenance

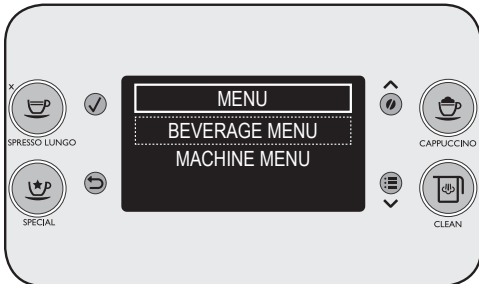

When you enter the programming mode:

- ✓ button = (confirms a selection or a change you have made)
- ^ button = (scrolls up the menu)
- ✓ button = (scrolls down the menu)
- ↩ button = (confirms when you exit a selection)

Press the ☰ Button

#### Beverage Menu

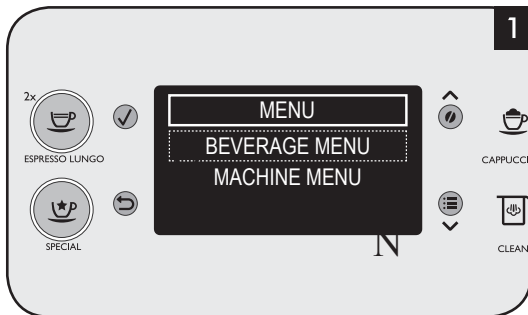

The machine can be programmed to tailor the coffee taste to your personal preferences. For each beverage it is possible to customize the settings. Press the ☰ button. Then press ✓.



Press the ✓ button to select the beverage that you wish to customize; press the ✓ button to confirm.

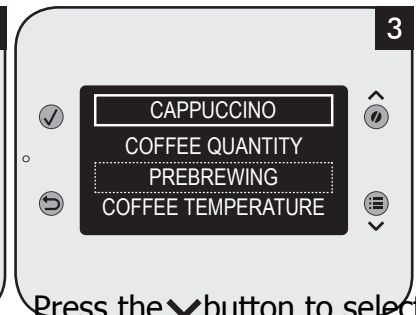

Press the ✓ button to select the setting that you want to adjust; then press ✓. Refer to the user manual for more details.

#### Machine Menu

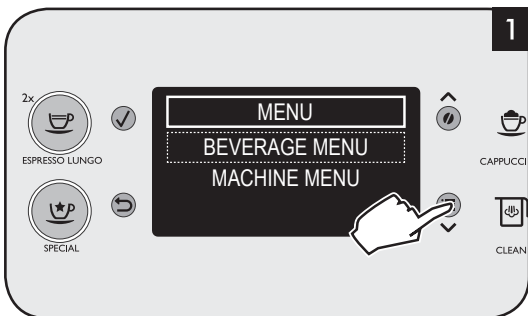

Press the ☰ Button

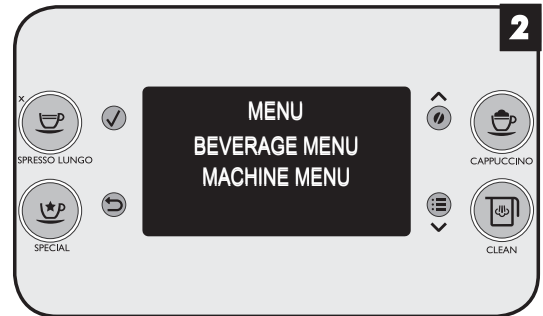

Press the ✓ button to select "MACHINE MENU"; press the ✓ button to access the menu.

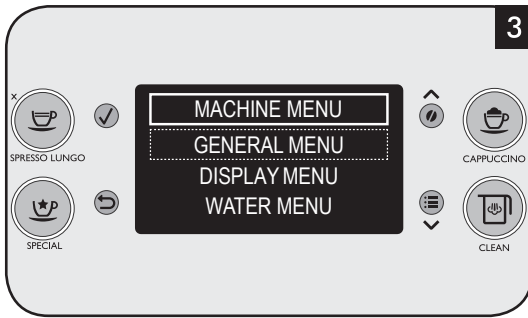

The machine menu allows you to customize the operation settings. It has 3 submenus.

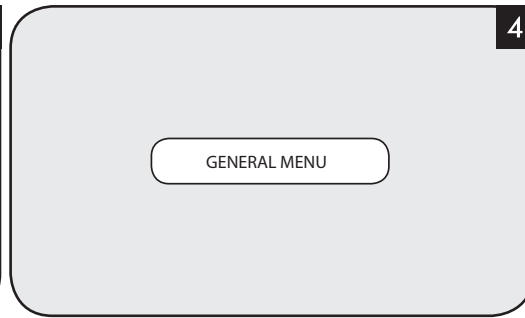

This menu allows you to change the tone, the ecomode and the stand-by.

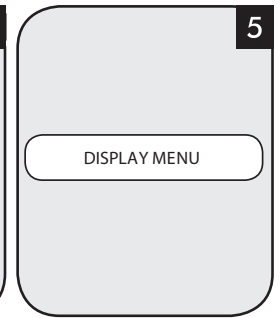

This menu allows you to change the language and the display brightness.

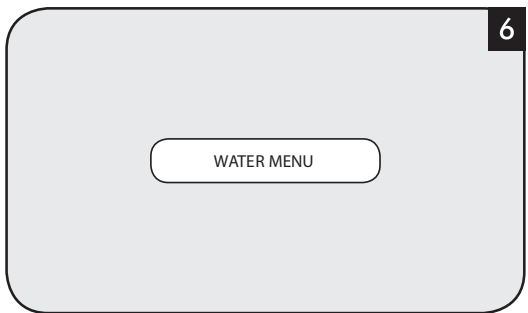

This menu allows you to set water hardness and manage the water filter.

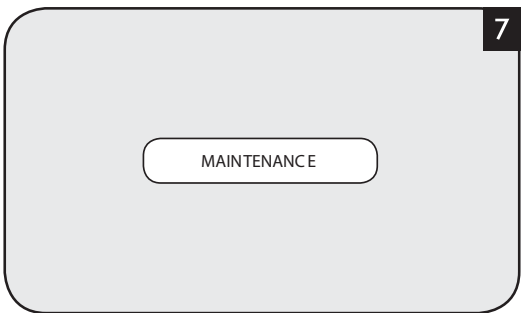

This menu allows you to perform maintenance operations.

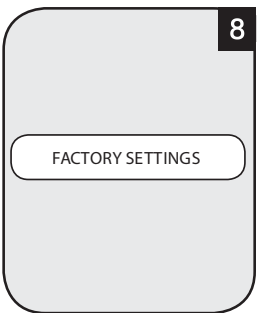

This function allows you to restore all factory settings.

### Meaning of the display

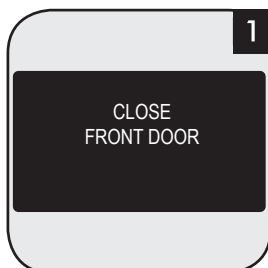

Close the service door



Open the service door and empty the internal drip tray.

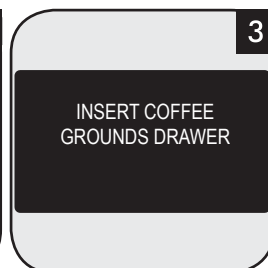

Insert the coffee grounds drawer and the internal drip tray.

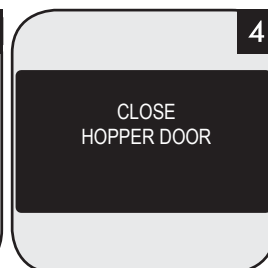

Close the coffee bean hopper inner cover.



Remove the water tank and fill it.



The brew group must be inserted into the machine.

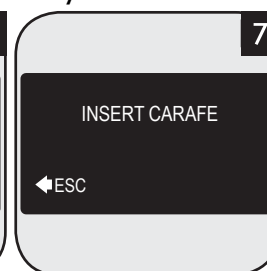

Insert the milk carafe to start brewing.

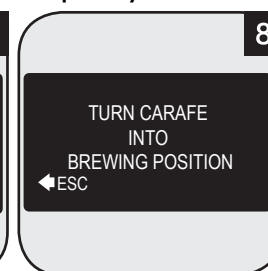

Open the milk carafe dispensing spout to brew products.

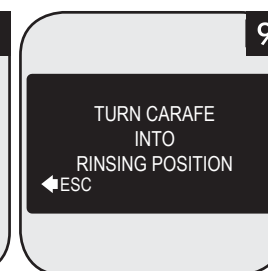

Close the milk carafe dispensing spout to start the carafe rinse cycle.

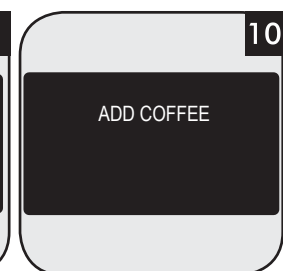

Fill the coffee bean hopper

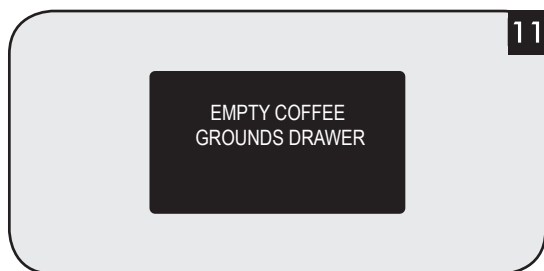

Remove and empty the coffee grounds drawer with the machine turned on.



An event has occurred which requires the machine to be restarted. Take note of the code (E xx) shown at the bottom. Switch off the machine, wait 30 seconds and then switch it on again. If the problem persists, contact the Philips SAECO hotline in your country and quote the error code shown on the display.

# **CHAPTER 4**

## **OPERATING LOGIC**

4.1. Water circuit

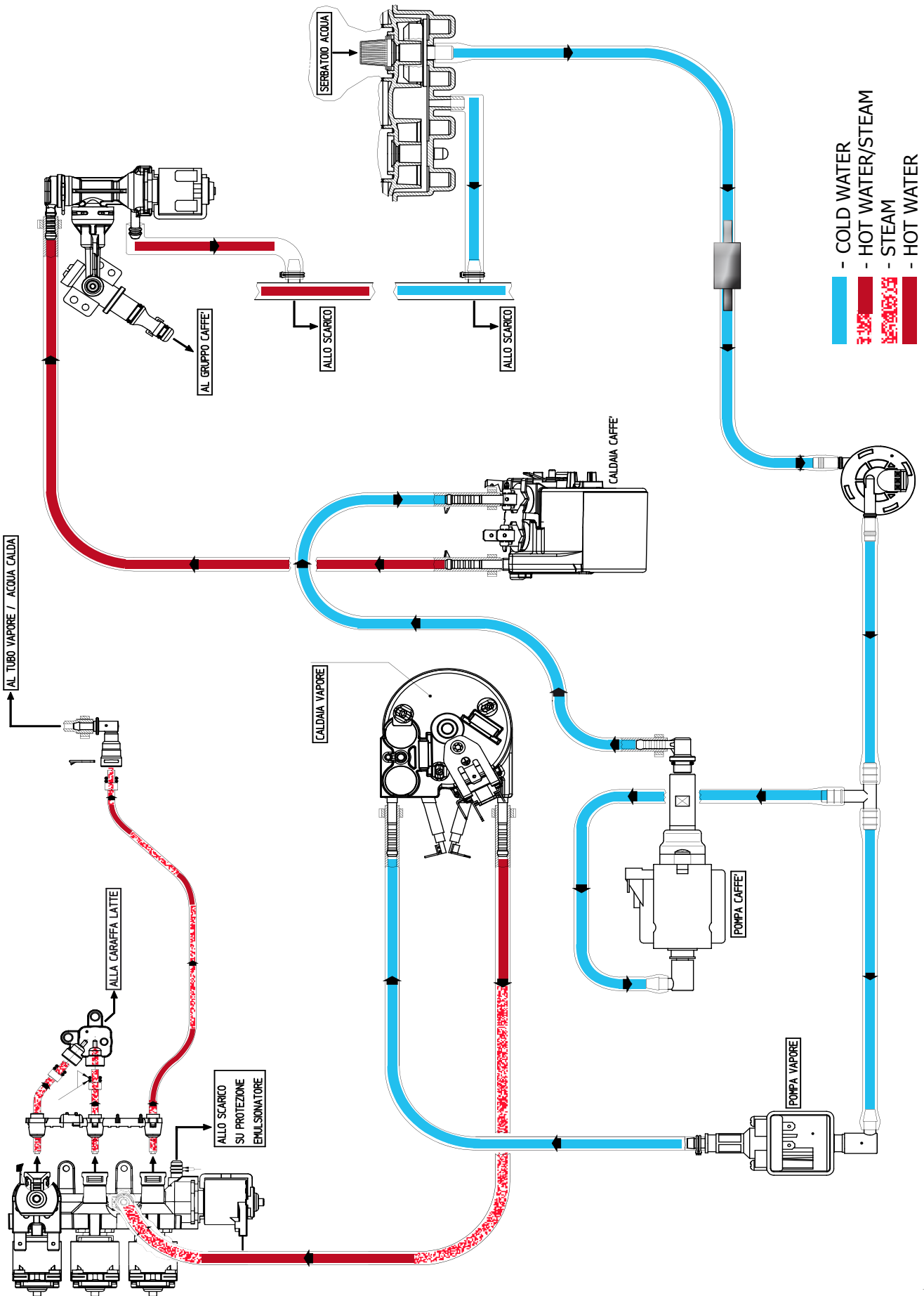

**4.2. Frother valve assembly**

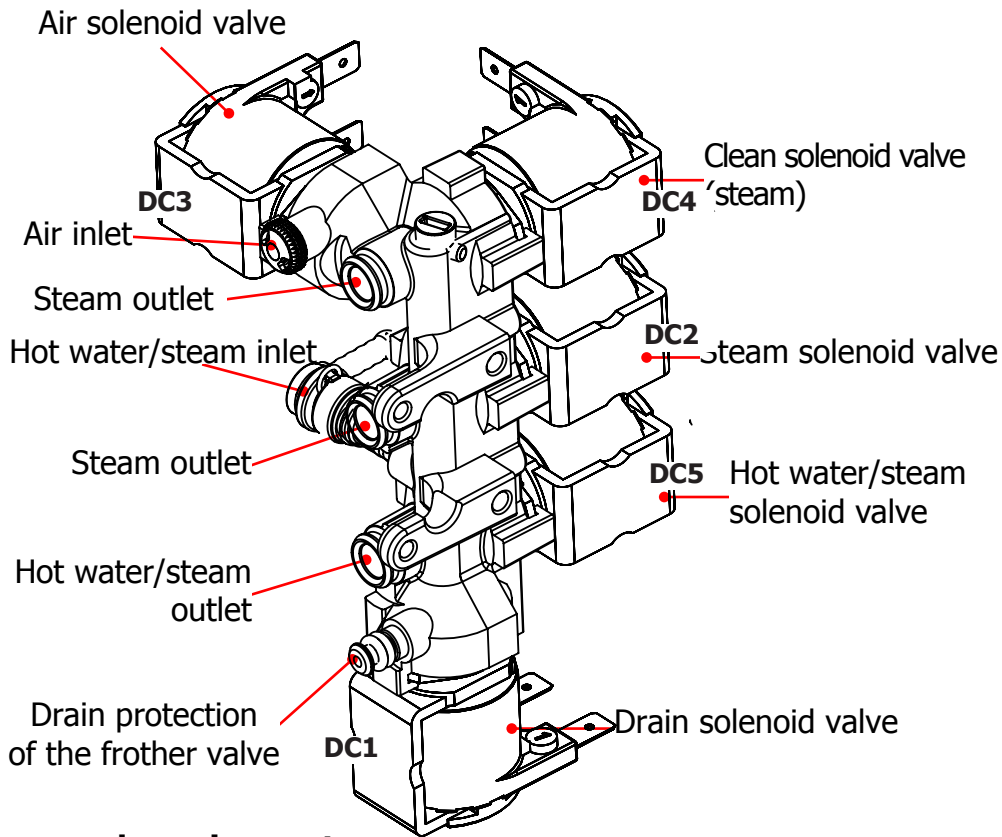

**Specifications and requirements**

Maximum operating pressure 3 bar

Maximum pressure in the water/steam circuit does not exceed 4.5 bar 0/+1

Hot water temperature 90°

Steam temperature 125°

**4.3. General carafe assembly**

1	Cappuccino-maker body
2	Milk suction pipe and fitting
3	Venturi pipe
4	Milk dispenser pipe
5	Upper fitting of the carafe drain pipe carafe
6	Lower fitting of the carafe drain pipe
7	Levers, springs and cam for the signalling of carafe presence/absence and the position of the dispenser

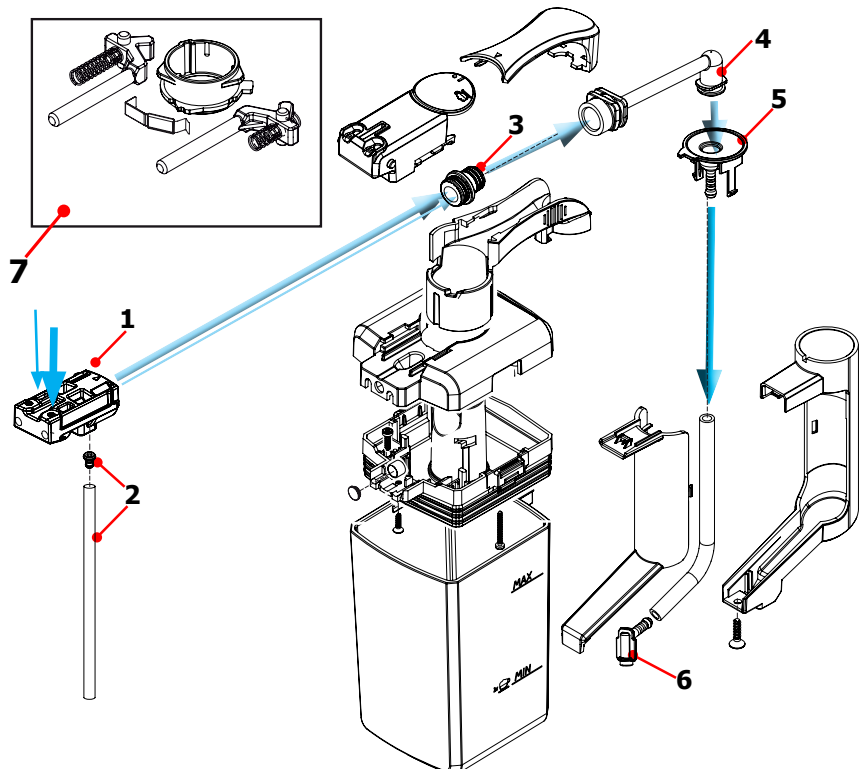

**Functional mode for the production of milk products and cleaning the circuit**

When the solenoid valves open and let air or hot water/steam through, the following situations occur:

- **DC3+DC2** STEAM + AIR = Frothing and heating of frothed milk
- **DC2** STEAM FROM CENTRAL HOLE = Heating of non-frothed milk
- **DC4** STEAM FROM LOWER HOLE = Cleaning of milk circuits

**DC1 = safety valve**  
**DC2 = steam valve**  
**DC3 = air valve**  
**DC4 = clean valve (steam)**  
**DC5 = hot water/steam valve**

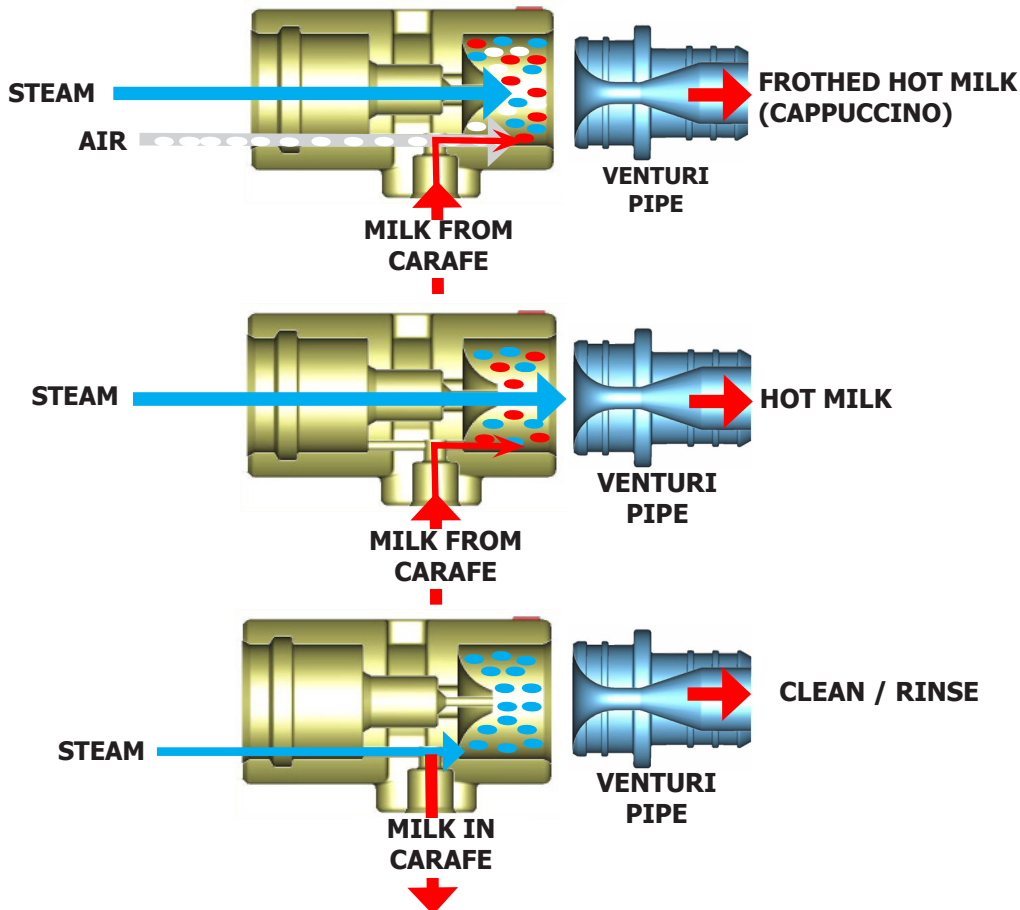
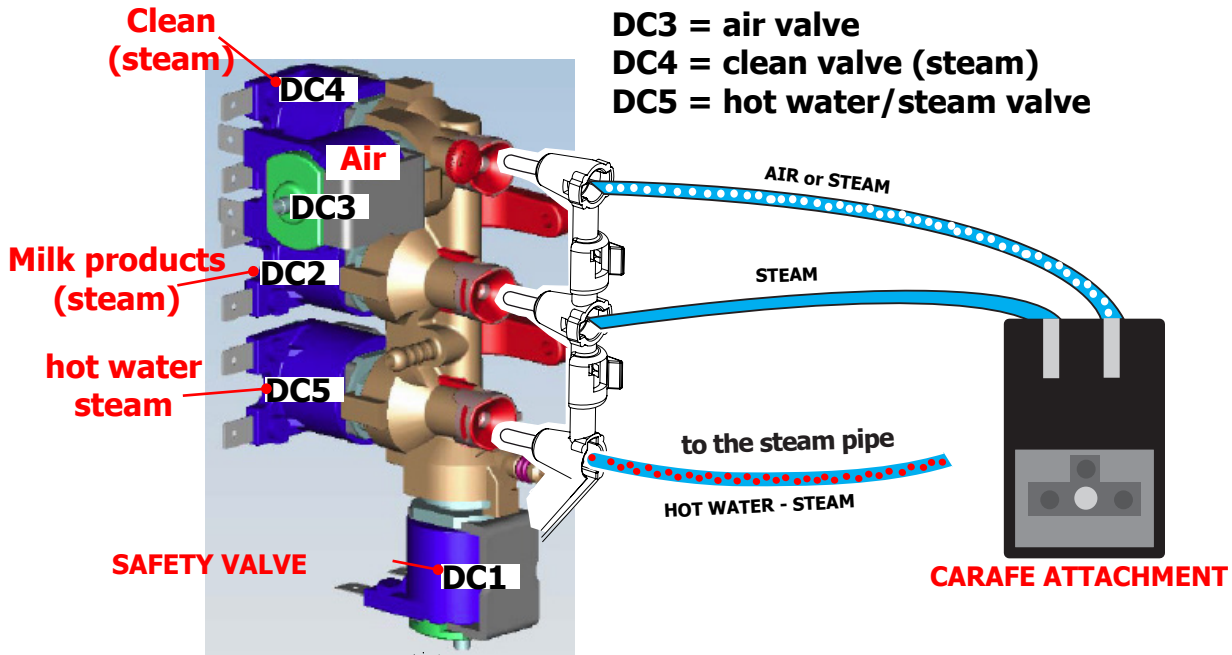

#### 4.4. Multi-way valve

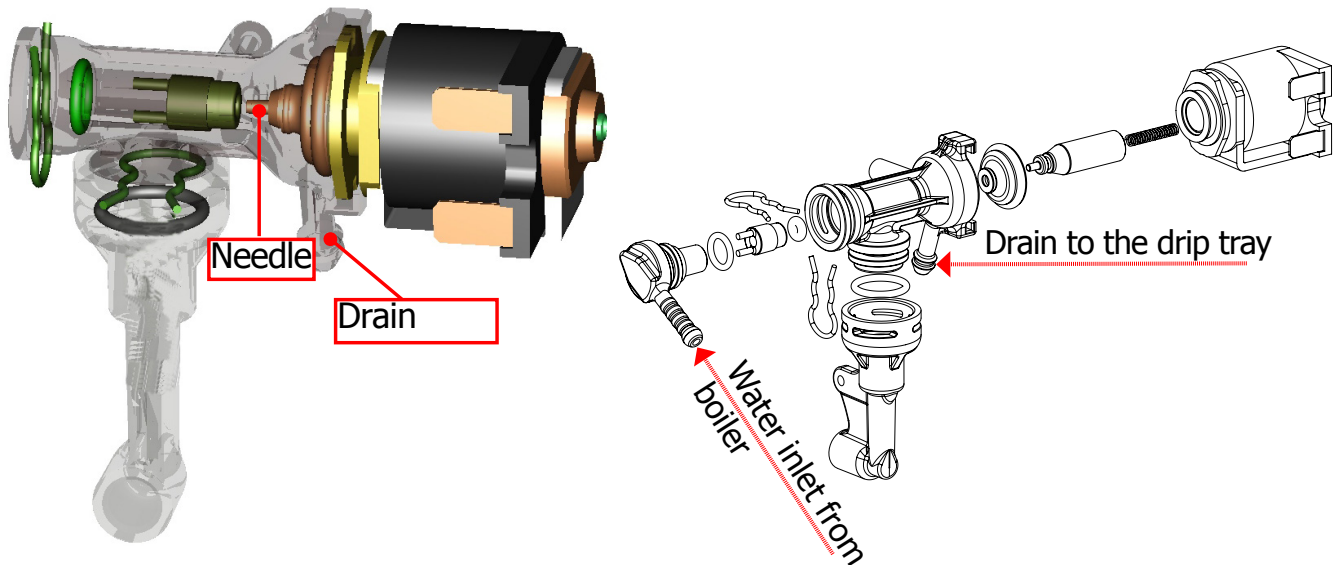

#### Functions:

**Safety valve:** opens towards the drain if the pressure exceeds 16-19 bar

**Filling the circuit:** the solenoid valve opens (drain position), the pump is controlled and automatically refills the circuit by expelling the air in the pipe

**Draining the unit:** before the unit descends, it opens briefly, releasing the pressure created to prevent the unit from spraying and making the pad drier

**Coffee product:** when a coffee beverage is selected, the pump is charged briefly during the grinding process and the valve assumes the drain position for hot water to pass through the pipes.



4.5. Coffee cycle

Main Switch ON	START		STOP
Time			
Coffee grinder			Pulses (Dosage)
Heating	approx.45 sec.		
Pump			Pump action (flow meter pulses) depending on the quantity of the product set *
Gearmotor Brewing unit			
Status	Heating	Ready	Coffee cycle

Notes: \* Only with Pre-brewing



Single microswitch gearmotor

Switching on

When the machine is switched on, the gearmotor repositions itself as follows:

- It stresses microswitch 1 (see the following chapter)
- The gearmotor changes the rotation direction and moves upwards again by approx. 1-2 mm
- The boiler begins to heat the water for approx. 45 sec. at full power in order to reach the optimal temperature. The temperature will then remain constant.

Coffee cycle

1. The coffee grinder starts the grinding process (controlled by pulses generated by a sensor)
2. The gearmotor (coffee unit) moves to the dispensing position
3. Preliminary dispensing phase (short pump activity, short pause)
4. The product is dispensed (the pump operation time depends on the amount of product dispensed)
5. The gearmotor moves to the idle position (the dregs are expelled automatically)

#### 4.6. Single microswitch

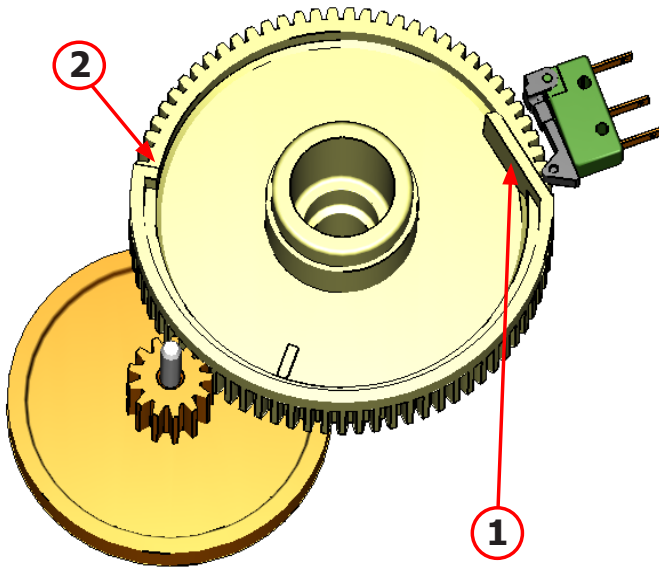

The gearmotor is activated by a direct current motor that acts on the smaller double toothed wheel via a worm screw. The unit is mounted on the axle of the large toothed wheel and when a coffee is requested, it moves from the idle position to the dispensing position to then return to the idle position.

- Idle position: 1

- Dispensing position: 2

#### 4.7. Temperature sensor (adjustment)

Temp. (° C)	R nom (kΩ)	ΔR (+/- %)
20	61.465	8.6
50	17.599	5.9
75	7.214	4.1
80	6.121	3.7
85	5.213	3.4
90	4.459	3.1
100	3.3	2.5
125	1.653	3.9
150	0.893	5.1

An NTC is used as a temperature sensor and in the event of overheating, it reduces the resistors consumption.

The electronic system detects the actual boiler temperature from the drop in voltage and adjusts it accordingly.

**Resistor values and corresponding temperatures:** see table

4.8. Coffee grinder

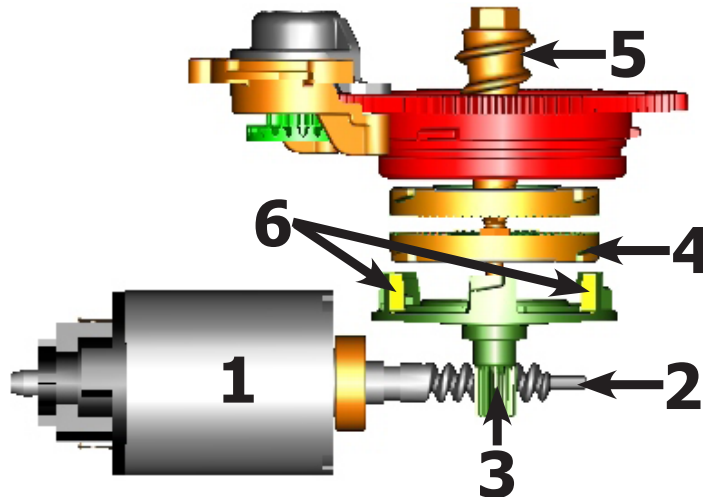

The coffee grinder is activated by a direct current motor (1) via helicoidal wheel transmission and a worm screw (2). The worm screw (2) activates a plastic toothed wheel (3), which turns the lower grinder blade (4) and the increment pin (5). There are two magnets (6) in the toothed wheel and with every rotation they transmit two pulses to a Hall sensor, which in turn transmits them to the electronic system.

4.9. Detection of coffee bean absence, dose adjustment, blocked coffee grinder

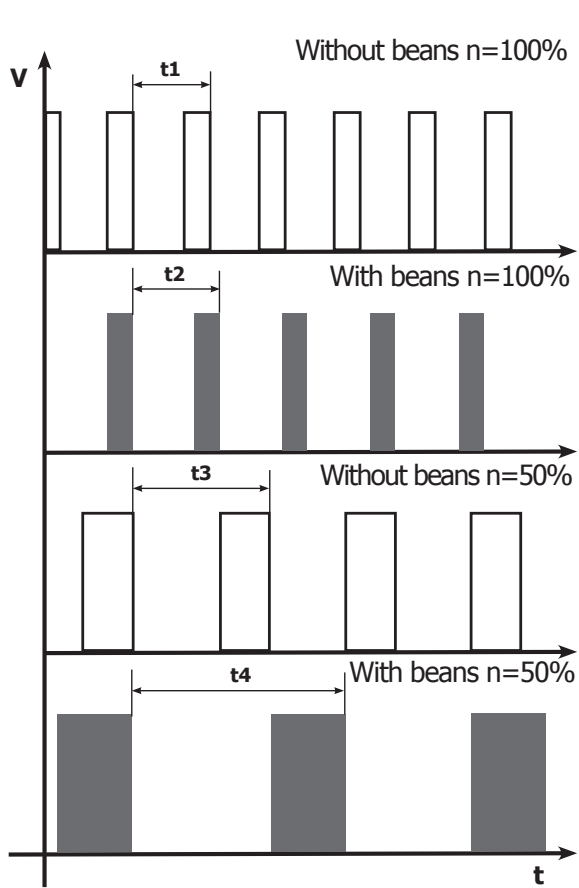

**No coffee**  
 when no coffee beans are present, this is detected by the Hall sensor due to variations in the pulse frequency (with or without coffee).  
 If there are no coffee beans (operation while empty), the number of rotations and therefore the number of pulses, will be greater  
**t1 = no coffee signal**

If there are coffee beans, the number of rotations will be lower due to the force created during the grinding process  
**t2 = no signal**

**t3 and t4 = this reading is taken**  
 at the end of each grinding process

**Dose quantity adjustment**  
 The dose quantity is adjusted in accordance with the pulses detected (number of rotations proportional to the weak, medium and strong flavour selection)

**Blocked grinder blades**  
 If the coffee grinder is blocked for any reason, pulses will no longer be transmitted to the electronic system and the grinder stops

### 4.10 Auto-learning dose (SAS)

The aim of this function is to automatically regulate the average dose of ground coffee (SELF-LEARNING); this takes place with an algorithm based on the following values and setting by the user:

1. Number of coffee grinder pulses during the grinding cycle.
2. Max. average value of the power consumed by the gear motor during the coffee brewing cycle.
3. Aroma selected by the user.

The algorithm compares the maximum average value of the power consumed by the gear motor with the value listed in the table for the selected aroma, in order to calculate the new grinding pulse value for the next coffee produced.

If the power consumption value is less than the minimum current value, the grinding pulses will be increased by 2.

If the power consumption value is greater than the maximum current value, the grinding pulses will be decreased by 4.

If the power consumption value falls within the "over-torque" interval, the product will be dispensed and the grinding pulses will be decreased by 10.

If the power consumption value falls within the "abort cycle" interval, the dreg will be expelled and the grinding pulses will be decreased by 10.

If the "pre-ground" flavour is selected by the user, no modification will be made.

**This guarantees that, regardless of the coffee type used, the grinding level setting and the wear on the grinders, the ground coffee dose always remains constant.**

		DOSE ADJUSTMENT (NUMBER OF GRINDER IMPULSES) TO APPLY TO MED AROMA						
		3 levels	5 levels	+2	0	-4	-10	-10 and CYCLE ABORTED
Aroma of the grinded product	A	Light	Very Light	MAX_CURRENT_mA <150mA	<=150mA MAX_CURRENT_mA <=250mA	MAX_CURRENT_mA >250mA	MAX_CURRENT_mA >800mA	MAX_CURRENT_mA >1000mA
	B	Med	Light	MAX_CURRENT_mA <250mA	<=250mA MAX_CURRENT_mA <=350mA	MAX_CURRENT_mA >350mA	MAX_CURRENT_mA >800mA	MAX_CURRENT_mA >1000mA
			Med					
	C	Strong	Strong	MAX_CURRENT_mA <350mA	<=350mA MAX_CURRENT_mA <=500mA	MAX_CURRENT_mA >500mA	MAX_CURRENT_mA >800mA	MAX_CURRENT_mA >1000mA
			Very Strong					

**Important:**

For perfect operation, machine adjustment should take place in the area of the fields highlighted in green (A, B, C). When the type or brand of coffee is changed, there may be variations in the size of the beans and their stickiness or roasting level. This leads to variations in power consumption (mA), with resulting excessive or insufficient doses (until the necessary adjustments have been made to compensate for this change).

**Caution: In the case of excessive dosage, powder may be expelled into the dreg drawer. This is not a fault, but can occur during preliminary operation or after a service.**

## 4.11. SBS

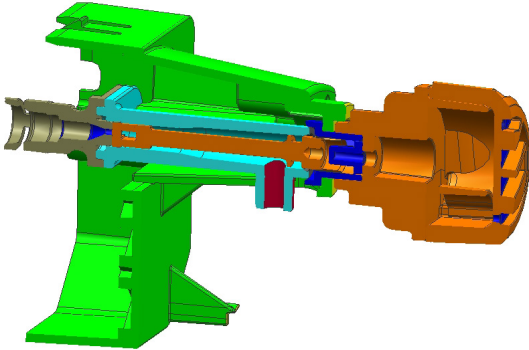
**SBS Principle - Saeco Brewing System**

Adjusting the flow speed, which influences the contact time between the coffee and water, alters the extraction and therefore the taste intensity and strength of the coffee.

- Slower flow: Stronger extraction
- Faster flow: Lighter extraction

**SBS dispensing valve**

Turning the SBS adjustment knob will trigger the brewing process in the coffee unit, where the flow speed is adjusted via a cream valve.

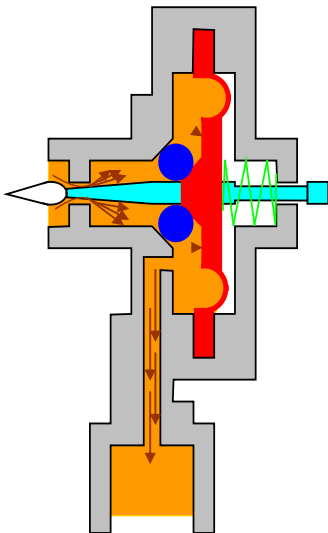
**Cream valve adjustment****Greater flow (light extraction)**

If the SBS valve is open, the coffee flows easily because the pressure is lower and the membrane remains almost in its base position with the help of the spring.

The adjustment needle does not close the opening and the flow does not decrease.

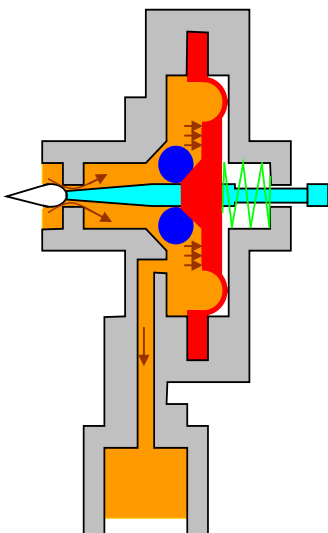
**Cream valve adjustment****Slow flow (strong extraction)**

The coffee is dispensed slowly with the SBS valve closed due to the pressure created, which acts on the membrane and presses it to the side against the spring force.

Lastly, the valve needle closes the opening, thereby, reducing the flow.

4.12 Water level detection in the tank

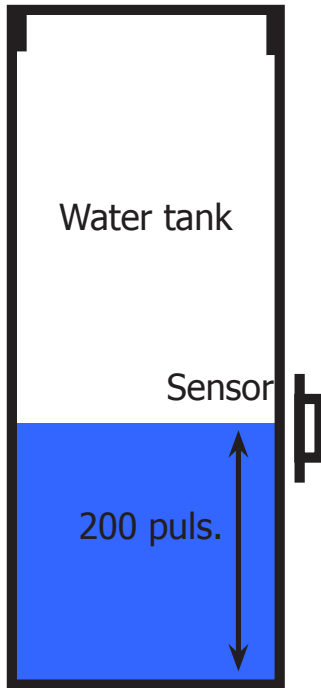

**Water absence signal (water reserve)**

**Function:**

The water level is monitored by a capacitive sensor, located one third up the water tank wall. If the electronic system detects that the water is below the relative level by means of the sensor, a water reserve of 200 pulses of the flow meter remains available for the dispensing process. The product dispensing process is then completed. If a dispensing process ends after the sensor has intervened (in the reserve), the "water absence" signal continues to be displayed as from the next dispensing process

4.13. Drip tray water level detection

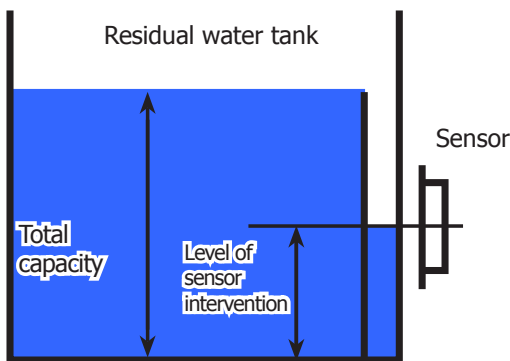

**Empty residual water tank signal**

**Function:**

The residual water level is monitored by a capacitive sensor. The sensor is located approximately half way up the upper edge of the residual drip tray. To make the best of the tray capacity, the sensor is positioned near a dam device. In this way, the residual water tray fills up to the upper edge and overflows inside and when it reaches the sensor, it triggers the "empty residual water tank" signal.

### 4.14. Descaling request in Exprelia Evo

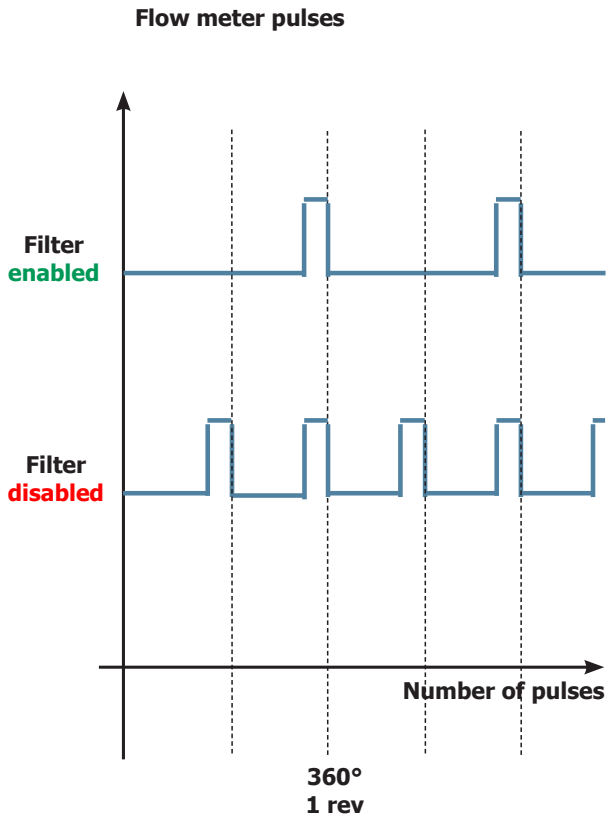

#### Descaling signal with anti-scale filter (only in appliances equipped with a display)

The water hardness is set on the basis of the regional water hardness analysis (1, 2, 3, 4).

#### Filter disabled:

If the function is **disabled**, the electronic system counts the flow meter pulses, recording **one pulse for every revolution**.

#### Filter enabled:

If the function is **enabled**, the electronic system counts the flow meter pulses, recording **one pulse for every two revolutions**.

#### "Change anti-scale filter" signal

The electronic system uses the flow meter pulses to keep track of the amount of water that flows and once the defined litres are exceeded (based on the water hardness setting), the "Replace filter" signal is triggered.

### 4.15. Anti-scale filter in Exprelia Evo

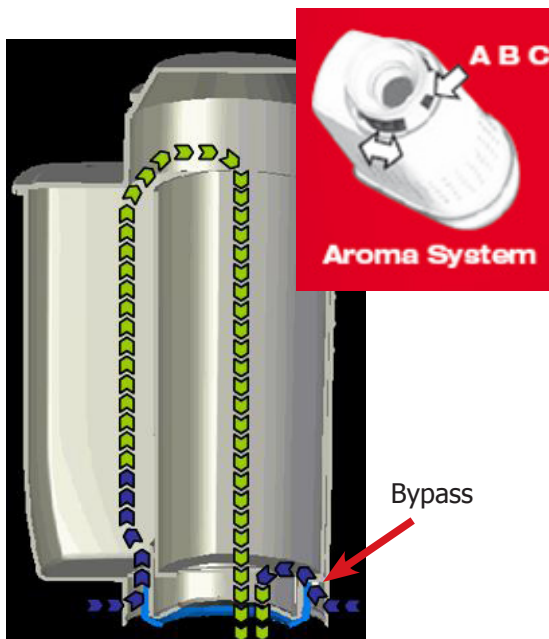

#### Anti-scale filter

#### Function:

- Reduced limescale deposits that take longer to form.
- Improved water quality.
- Better taste due to ideal water hardness.

#### Descaling duration / efficiency:

- - 10° dH
- 60 litres
- 2 months

To obtain a linear characteristic of its effectiveness, throughout the duration of the descaling process, the water is split according to the degree of hardness in a three-phase by-pass (A, B and C). See small picture.

**4.16. AquaClean water filter Exprelia Evo V2**

The SAECO AquaClean water filter purifies the water your machines uses for brewing coffee. This results in a greater coffee taste. Moreover it prevents mineral deposits in the

Water to build up, which eliminates the need of descaling your machine for 500000ml of water.

We recommend installing the water filter AquaClean the first use of the machine to the maximum before using 5000 ml of water.

After a period of uses the machine, the display will indicate when the filter needs to be replaced, the maximum limit equivalent to 62500ml.

In this way you can replace the filter 8 times without the need for descaling. This equals approx. 500000ml of water.

When Aquaclean filter is activated the display will show an icon indicating the percentage of use (initially 100%) .

The filter should be replaced after a maximum of 62500ml of water or after 3 months of use (maximum time of law)

The filter can not be deactivated manually, as it must end its life cycle.

The filter symbol flashes slowly when the autonomy of the current filter becomes less 8050ml (percentage shown on the display 10%). When the autonomy of the current filter becomes less than 2000ml (percentage shown on display 0%) the icon flashes quickly. After a maximum of 62500ml of water supplied the flashing light turn off. Because you did not activate a new filter, the machine will show that after a while' you need to start descaling.

After the flashing light goes out is calculated:

(for example) After using 1 filter, the TH reduces of 1/8. With Water hardness 4 and brewing just coffee/ water products the TH is set to 30 liters. 30 liter minus 1/8 is 26,25 liters. The first filter expires at 62,5liters - > the warning "DESCALE" should appear at 26,25+62,5 = 88,75 liters from start.

If the consumer is using the AquaClean filter, and replaces it when indicated by the machine. The machine needs to be descaled after 8 filter replacements. When the 8th filter needs to be replaced the machine will inform you need to descale before placing a new filter.

Note: the quantities of water, for each cycle of the filters, are not affected by the hardness of the water itself.

The machines : Intelia Evo2 , Granbaristo V2 , Exprelia V2 , New Incanto e Cattiva will mount a water container can only mount the filter Aquaclean and will not be able to mount the old.

**Descaling frequency in AQUACLEAN**

The first activation must make before you've paid up to 5000ml products because mind thinks as if he had the filter

Hardness	Filter number	Percentual on display 10% the icon flashes slowly.	Percentual on display 0% the icon flashes quickly.	MAX Quantity water, the icon turns off. (replace filter)	
Indifferent	From 1/8 to 7/8	8050ml	2000ml	62500ml	Replace filter (you can not turn off)
	8/8				Descaling

**If after descaling or after the use of a filter this is not reactivated , the machine recognizes the water hardness setting and calculates as in the table below**

**Descaling cycle frequency**

Hardness	WATER HARDNESS	Without water filter	Not reactivating the filter
<b>1</b>	Soft (up to 7°dH)	240 litres (480,000 pulses)	210 litres (420,000 pulses)
<b>2</b>	Medium (7° - 14°dH)	120 litres (240,000 pulses)	105 litres (210,000 pulses)
<b>3</b>	Hard (15° - 21°dH)	60 litres (120,000 pulses)	52.5 litres (105,000 pulses)
<b>4</b>	Very hard (over 21°dH)	30 litres (60,000 pulses)	26.25 litres (52,500 pulses)

The default water hardness level is 4. Each litre of water corresponds to approximately 2,000 pulses.



# **CHAPTER 5**

# **TROUBLESHOOTING**

5.1. Test mode Exprelia Evo V2

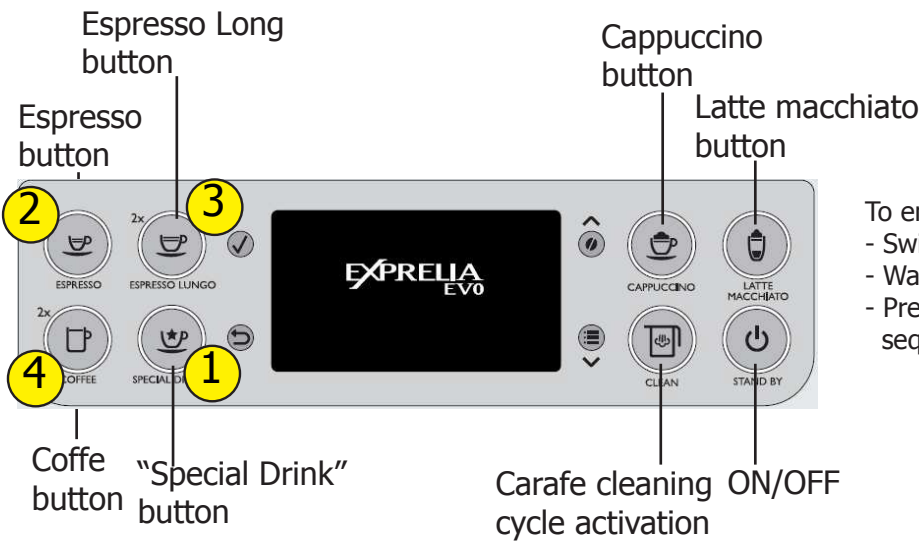

To enter Test Mode:  
 - Switch on the machine  
 - Wait until the display lights  
 - Press the four function keys in the sequence indicated (1, 2, 3, 4)

**Description**

When the machine is in Factory Test Mode appears a windows divided in several sectors:

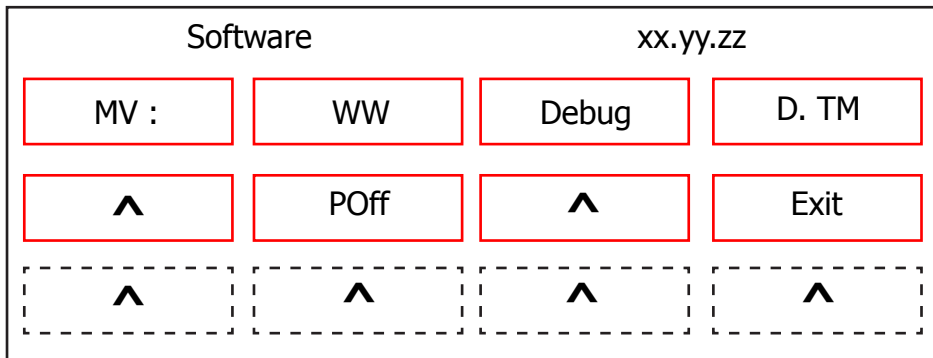

The first row of each window is a title, the red sectors represents the functions (or loads) available to activate or deactivate, the last row is used to show other info. When a function is enabled the corresponding box becomes colored. The dotted sectors is used to show informations about the status of microswitch, sensors or other variables. The presence of symbol (^) into a sector indicate that no function is associated to.

The following image show the corrispondence between the keyboard and red sectors:

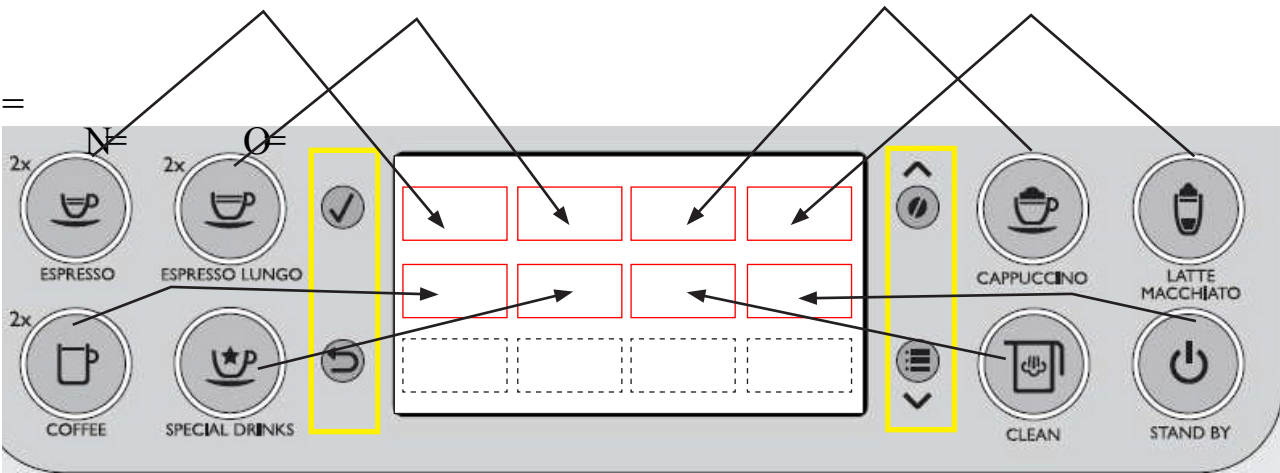

The keyboard buttons (ESC, OK, UP and DOWN), highlighted in yellow, have the following functions:

- UP** : go to next page
- DOWN** : go to previous page
- OK ( )** : confirm / enable / disable function
- ESC ( )** : exit from Factory Test Mode

### Activation of loads

In Test Mode all loads are initially disabled.

To activate a load press the corresponding button on keyboard, to deactivate press again the same button.

Other conditions for which a load may be switched off automatically without key presses are:

- If it is defined a working cycle, when this cycle ends (such as the grinder or brew unit)
- The achievement of a Time-out (Example 5 minuts for boiler)

### Navigation in Test Mode

#### SoftwareVersion

This is the first window of Factory Test Mode. It show the version of CPU software (xx.yy.zz.) , the EEprom version (ww) etc.

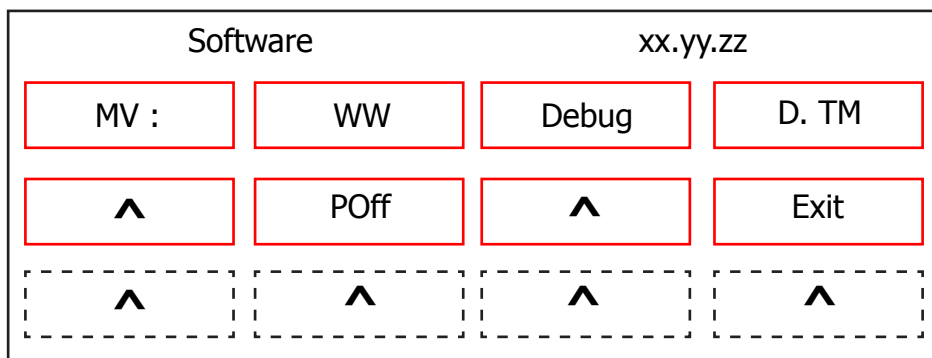

The first two fields in the upper left indicate the version number of EEPROM MV (Memory Version) : ww).

Pressing DOWN will switch you to the next screen. Pressing the POWER ON-OFF mode is exited test

or you can press to exit at any page of the test mode ESC.

#### Commands:

- Debug: if active enables debug messages dell'autodose only for the next reboot
- D.TM: when active enables the possibility of entering the test mode of the display when you reboot machine
- Poff: if activated allows the machine to immediately enter into standby after power from the main switch.

Following the activation of debug messages, the display will be visible the following information:

- Effort of the group at the last grinding
- Actual number of pulses that produced the effort of the brew unit
- Pulse aroma medium after correction dell'autodose following the last grinding

The effort of the brew unit and the actual number of pulses corresponding to it, are available in the display

As soon as the brew unit moves into "work" while impulses aroma medium, correct dall'autodose, are visible when the machine returns to "ready".

Following the activation of debug messages, the display will be visible the following information:

- Effort of the group at the last grinding
- Actual number of pulses that produced the effort of the brew unit
- Pulse aroma medium after correction dell'autodose following the last grinding

The appearance of the display in the ready machine with messages debug actives is as follows:

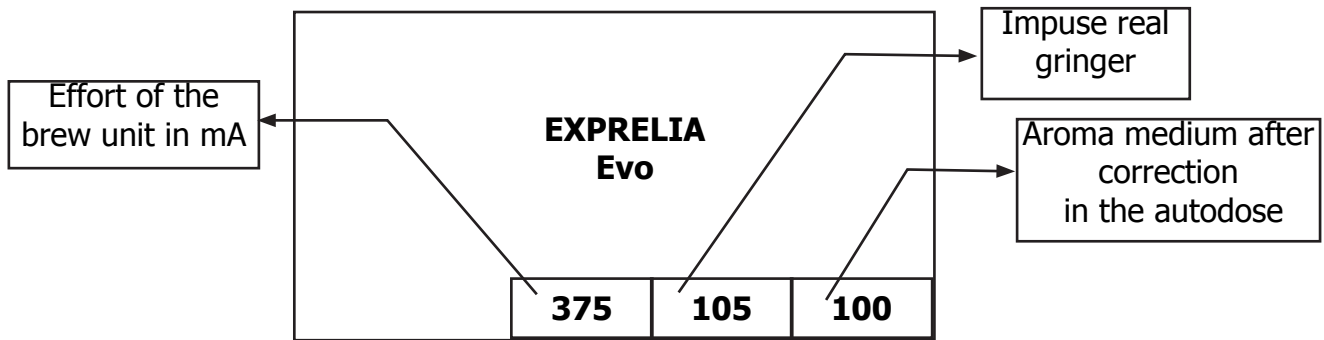

Upon activation of the flag D. TM restarting the machine (eg leaving the test mode) will be possible enter the test mode display by simultaneously pressing: LATTE MACCHIATO AND POWER ON-OFF while filling the bar at StartUp. The complete filling of the bar clears the flag D. TM.

Once in test mode display will appear on the display screen type:



By pressing the ESC key you can exit the display test. Pressing the OK button you can switch from one image to the next test; The test images are the following:

Image 1



All pixels are on

Image 2



Chess board 2x2 pixels

Image 3



Reverse image of 2

Image 4



Concentric circles

After the 4th test image by pressing the OK button reduces the brightness (same as that set for the screen savers). Pressing the OK button again starts from the 1st test image.

## Keyboard

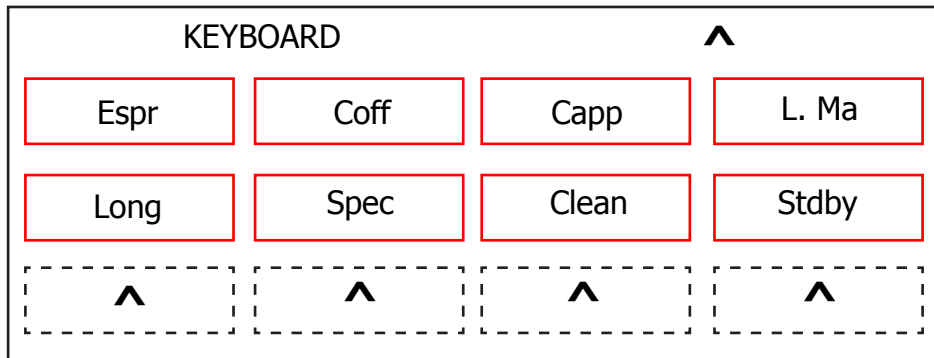

This is the button test page: each beverage corresponds to a box on the display that changes colour when the corresponding button is pressed.

Press DOWN  to move to the next screen

## Brew Unit

This screen corresponds to the management of the area inside the front hatch.

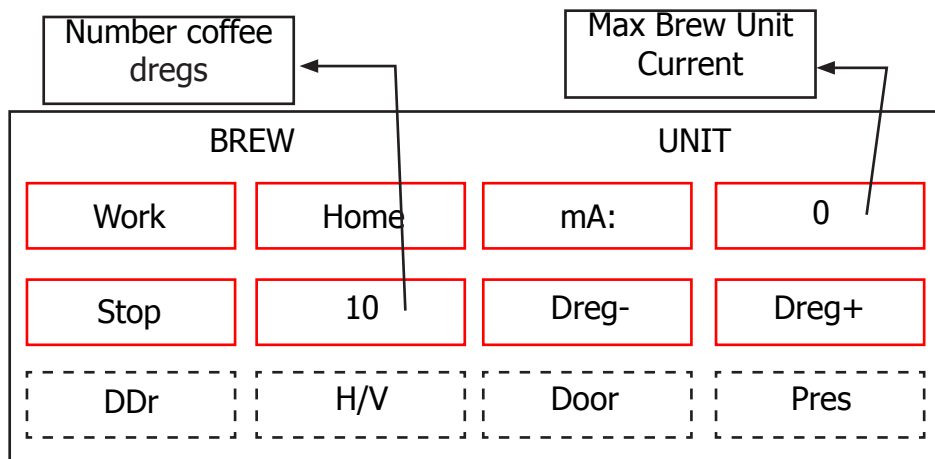

The meaning of the various fields is as follows:

### Operation:

- WORK: if pressed, switches the unit into its work position
- STOP: if pressed, stops the unit instantly
- HOME: if pressed, switches the unit into its Home position
- DREG UP: increases the coffee dregs counter
- DREG DOWN: decreases the coffee dregs counter

### Indicators:

- mA: indicates moment by moment the maximum current (in mA) consumed by the unit when moving. Its value must not exceed 300 mA
- H/W: becomes active (illuminated) when the unit reaches a "Work" position
- Pres: if active, this indicates that the unit is inserted
- DDr: if active, this indicates that the dregs counter is inserted
- Door: if active, this indicates that the front hatch is closed

Press DOWN  to move to the next screen

**Hydraulic Circuit**

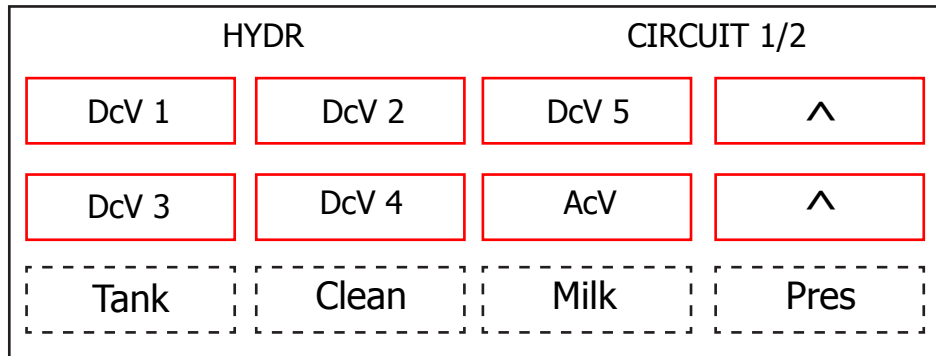

**Operation:**

- Ac V: if pressed, activates the 230V solenoid valve
- Dc V1: activates the 24V solenoid valve for draining
- Dc V2: activates the 24V steam dispensing solenoid valve
- Dc V3: activates the 24V milk frothing solenoid valve
- Dc V4: activates the 24V solenoid valve for milk circuit cleaning
- Dc V5: activates the 24V hot water dispensing solenoid valve

**Indicators**

- Tank: indicates the status of the water tank level sensor. If activated, the sensor signals that the level has been reached
- Clean: if activated, it indicates that the milk carafe is in the CLEAN position.
- Milk: if activated, it indicates that the milk carafe is in the MILK dispensing position
- Pres: if activated, it indicates that the milk carafe is inserted

**Press DOWN  o move to the next screen**

**Hydraulic Circuit**

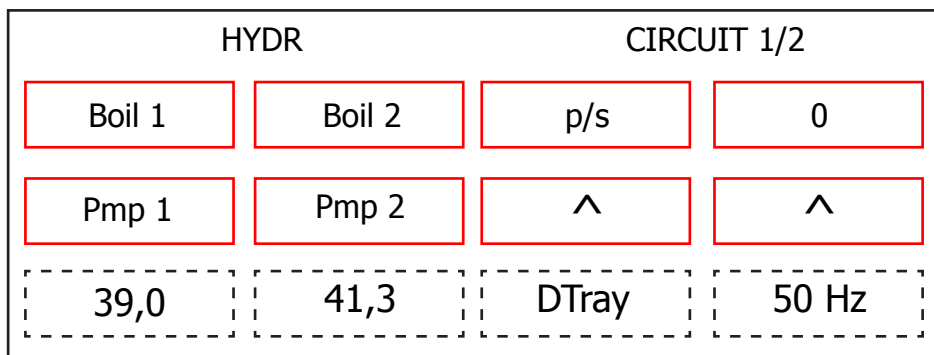

**Operation:**

- Boil1: if pressed, this activates the coffee boiler. The boiler is deactivated either by pressing the button again or automatically after 5 seconds. The temperature is indicated in the corresponding window at the bottom
- Boil2: if pressed, activates the steam/hot water boiler. The boiler is deactivated either by pressing the button again or automatically after 5 seconds. The temperature is indicated in the corresponding window at the bottom
- Pmp1: activates the hot water dispensing pump. The pump is switched off by pressing the button once more
- Pmp2: activates the hot water/steam dispensing pump. The pump is switched off by pressing the button once more

**Indicators**

- p/s: indicates moment by moment the water flow rate in the turbine, expressed in pulses per second. When coffee pump 1 is switched on and the coffee solenoid valve is on (AcV on the previous screen) the value must be no lower than 10 p/sec. When hot water/steam pump 2 is switched on and the drain solenoid valve is on (DcV5 on the previous screen) the value must be no lower than 5 p/sec.
- 50 Hz: indicates the mains electricity voltage frequency.
- DTray: indicates the status of the tray level sensor. If activated, the sensor signals that the level has been reached

Press DOWN  o move to the next screen

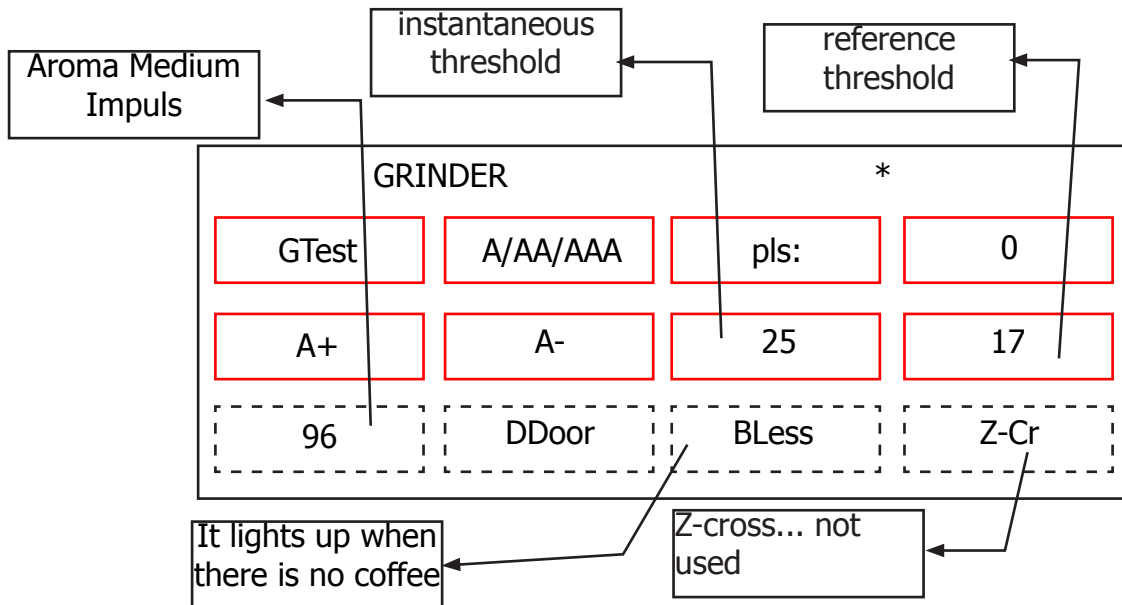
**Grinder****Operation:**

- A/AA/AAA: Selection of the aroma. When pressed it changes the flavor and then the number of pulses of the grinder according to the aroma selected. The symbolism is: A = MILD (lightweight), AA = MEDIUM (medium), AAA = STRONG (strong).
- GTest: if pressed, activates the coffee grinder. To stop it, press the button again. If stopped, the no-coffee test is run. At the end of the test, 2 values will appear in the "instantaneous threshold" and "reference threshold" windows: if "instantaneous threshold" is less than the "reference threshold" the system considers that the coffee grinder is empty

**Indicators:**

- Pls: indicates, during grinding, the real-time grinding pulse countdown
- BLess: This is activated when the system detects there is no coffee. To cancel the alarm you need to raise and lower the bean cover to simulate coffee loading
- BDOOR: indicates the status of the bean hopper door sensor (if active, it indicates that the door is closed)
- A+: increases the number of pulses for a medium aroma
- A-: decreases the number of pulses for a medium aroma
- Z-cr:... not used

The value at bottom left is the number of pulses for a medium aroma: it is modified manually with the "A+" and "A-" keys or automatically by the automatic dosing algorithm

Press DOWN  o move to the next screen

## Display

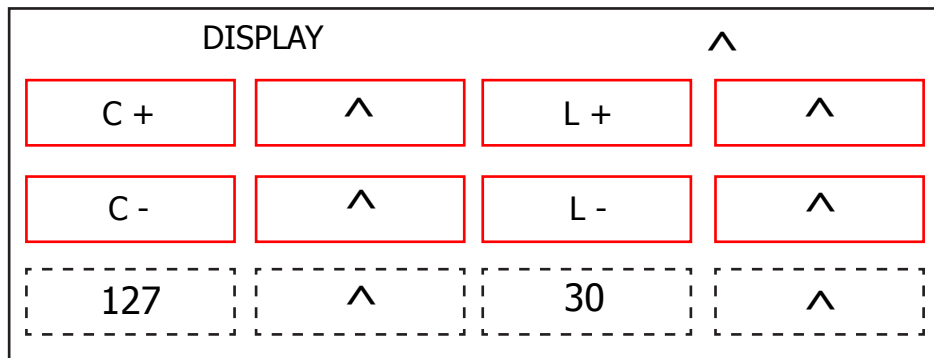

### Operation:

- C+: increases the contrast of the display
- C-: decreases the contrast of the display
- L+: increases the brightness of the display
- L-: decreases the brightness of the display

### Indicators

- The values at the bottom are indices representing the brightness and contrast: in this case these values are not saved to eeprom as they have solely a test function

Press **DOWN**  to move to the next screen

## 5.2. Steam-out

Before executing the steam out procedure, descale the machine taking care to remove the Aqua-clean filter from the appliance.

In case the filter on the machine is active (or it's in the machine) provide the consumer with a new one.

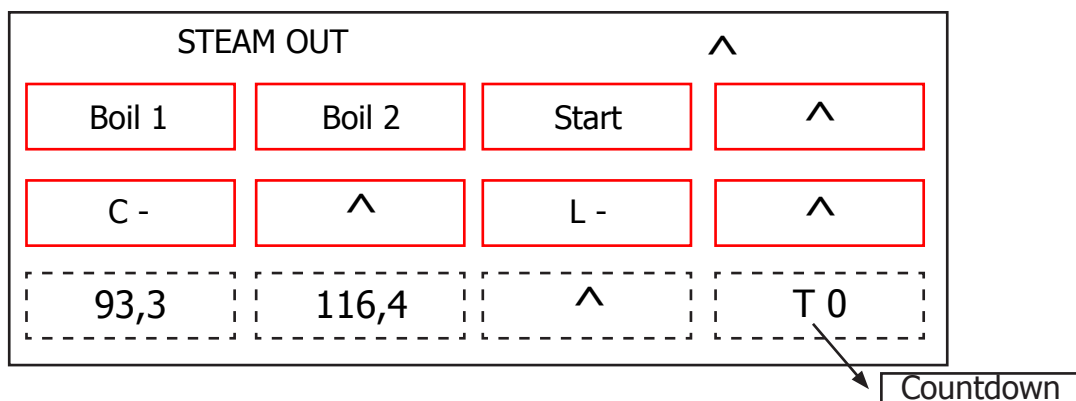

### Operation:

- Boil1: illuminates when the coffee boiler is powered
- Boil2: illuminates when the steam boiler is powered
- Start: starts the draining process

### Indicators:

- The values at the bottom are the temperatures of the two boilers and the countdown (T.O) before the machine requests switching off.

This is the last screen of the Test Mode. Press **UP**  to go back to the previous screens.

On each screen, pressing ESC exits the TEST mode and restarts the appliance in normal mode.



### 5.3. Diagnostics mode EVO 2

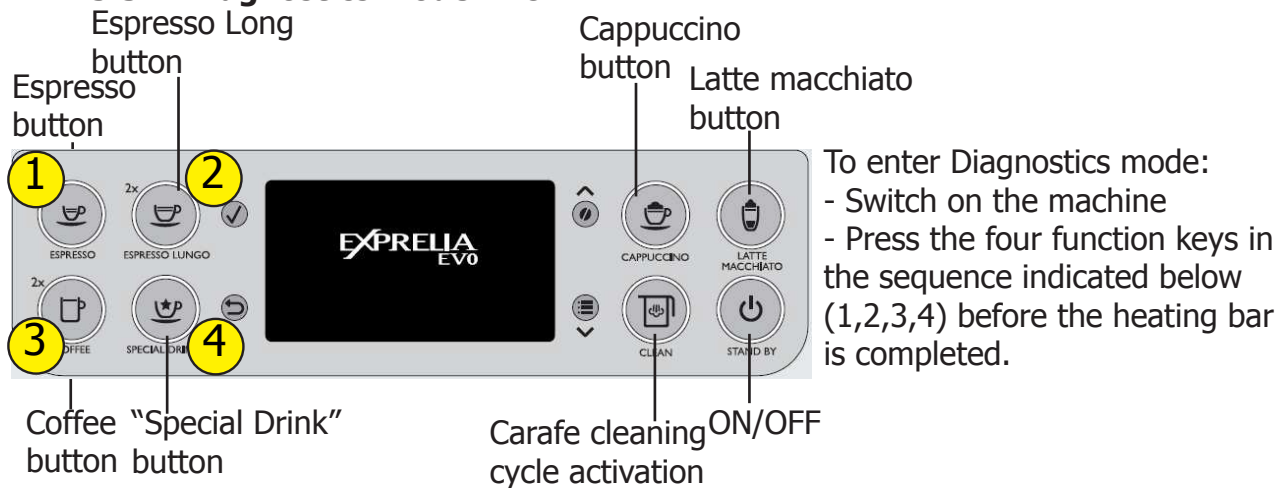

Description of the menu as diagnosis mode.

#### To enter Diagnostics mode:

- Switch on the machine
- Press the four function keys in the sequence indicated below (1,2,3,4) before the heating bar is completed.

#### 1. Product counters

- Espresso
- Coffee
- Espresso lungo
- Hot water
- Cappuccino
- Latte macchiato
- Hot milk

#### 2. Error counters

##### 2.1. Error log

- Error code
- Error index
- Error text

##### 2.2. Errors reset

#### 3. Water counters

##### 3.1. Descaling cycle

- Since last
- Since second last
- Since third last
- Number of execution

##### 3.2. Brewing unit cleaning

- Number of execution
- Since last

##### 3.3. Since production

##### 3.4. Water filter

- Since last reset
- Number of reset

#### 4. Max grinder dose

- 100 ÷ 170

#### 5. Max ground

- 10 ÷ 20

4. Service settings		
1. Product counters	Espresso (value default 0)	
	Espresso Lungo (value default 0)	
	Coffee (value default 0)	
	Cappuccino (value default 0)	
	Latte macchiato (value default 0)	
	Milk Froth (value default 0)	
	Hot water (value default 0)	
	Steam (value default 0)	
	Ristretto (value default 0)	
	Espresso Macchiato (value default 0)	
Flat Write (value default 0)		
2. Error counters	2.1. Errors log (valore di default 0)	Error code
		Error index
		Error text
	2.2. Errors reset	
3. Water counters	3.1. Descaling cycle	Since last (value default 0)
		Since second last (value default 0)
		Since third last (value default 0)
		Number of execution (value default 0)
	3.2. Brewing unit cleaning	Number of execution (value default 0)
		Since last (value default 0)
	3.3. Water since production (valore di default 0)	
	3.4. Water filter	Since last reset (value default 0)
Number of reset (value default 0)		
4. Max grinder dose	100 ÷ 170 (value default 170)	
5. Max ground	10 ÷ 20 (value default 10)	

## Detailed description of the menu so diagnosis

### Product counters

"Product counters" represents the number of deliveries carried out by the CA for each product:

Espresso

Espresso Lungo

Caffee

Cappuccino

Latte macchiato

Hot water

Hot milk

### Error counters

"Error counters" displays the total number of errors "out of service" (fail) occurred in the system (see "Errors log"), and allows you to reset the drive (see "Errors reset").

The maximum number of "Fail" count is 20.

The submenu "Errors log" is available only if there is at least one error and, If so, it presents the following information:

- Error code: is the numerical code for the type of fail occurred in the system. For example, "Error code 15" is the error with index 15 and is equivalent the steam boiler timeout.
- Error index: is the numerical position of the error in the internal list. the maximum number of items on the list is 20: the list is handled in a circular fashion, that is, the data in the first place is always the last error occurred in chronological order.
- Error text: is the text description of the type of error that occurred in system. For example: "Boiler steam out".

The cancellation of the error list via "Errors reset", as eliminates all information about them, also prevents access to the submenu "Errors log".

ERROR CODE EXPRELIA	
NOTE	CODE
Grinder blocked	ErrorCode_01
Brewing UNIT blocked work	ErrorCode_03
Brewing UNIT blocked home	ErrorCode_04
Water circuit interrupted	ErrorCode_05
DC valve short circuit	ErrorCode_06
Coffee temp. sensor short circuit	ErrorCode_10
Coffee temp. sensor open circuit	ErrorCode_11
Steam temp. sensor open circuit	ErrorCode_12
Steam temp. sensor short circuit	ErrorCode_13
Boiler coffee timeout	ErrorCode_14
Boiler steam timeout	ErrorCode_15
Brewing unit short circuit	ErrorCode_16
Zero crossing error	ErrorCode_19
Boiler coffee overheating	ErrorCode_20
Boiler steam overheating	ErrorCode_21

**Grinder blocked:** there is the absence of pulses from the grinder.

In this case the C.A. It hangs in the instant in which the user asks the machine to dispense a drink made of coffee (only coffee beans).

**Brewing unit blocked work:** Occurs when the brewing unit can not move from work to the home position.

**Brewing unit blocked home:** Occurs when the brewing unit can not move from home to the work position.

**Water circuit interrupted:** occurs when the flow meter is broken, disconnected or It does not occur passage of water. In these cases, since the C.A. can not correctly read the pulses of water, enters alarm condition "CHARGING CIRCUIT" in the moment in which the user asks to dispense a product: if the "charging circuit" fails C.A. blocked.

**DC Valve short circuit:** occurs when one of the valves of the flute is shorted circuit. Such a problem may occur during dispensing of a product based on milk.

**Coffee temp. sensor short circuit:** occurs when the temperature sensor coffee boiler is shorted. This error causes a blocking in C.A. to start-up.

**Coffee temp. sensor open circuit:** occurs when the temperature sensor coffee boiler is not detected. The problem is due to the absence of the signal of the sensor and does not allow to determine the C.A. the actual temperature of the boiler coffee. At start up, the C.A. blocked.

**Steam temp. sensor open circuit:** occurs when the temperature sensor steam boiler is not detected. The problem is due to the absence of the signal of the sensor and does not allow to determine the C.A. the actual temperature of the boiler steam. At start up, the C.A. blocked.

**Steam temp. sensor short circuit:** occurs when the temperature sensor boiler steam is shorted. This error causes a blocking in C.A. to start-up.

**Boiler coffee timeout:** occurs when no power coming to the boiler coffee, this does not reach the predetermined temperature within a time equal to 120 seconds. At start-up the AC, is continually on the screen HOLD FIRST TEMPERATURE, with the message "Warming up ...", and after the expiry of the time Out to fault

**Boiler steam timeout:** occurs when no power coming to the boiler steam, this does not reach the predetermined temperature within a time equal to 120 seconds.

**Coffee boiler overheating:** occurs when the temperature of the coffee boiler exceeds 150 ° C.

**Steam boiler overheating:** occurs when the temperature of the steam boiler exceeds 170 ° C.

**Brewing unit short circuit:** occurs when the supply of the complete group has in short circuit.

**Zero crossing error:** occurs when the C.A. It does not detect the signal zero crossing.

**Water counters**

"Water counters" shows the consumption of water (in pulses) following the granting of products, to the descaling cycle, cleaning cycle, the activation group and filter.

**The submenu "Descaling cycle" has the following items:**

**Since last cycle:** is the consumption of water after the last cycle descaling.

**Since second last:** it represents the consumption of water after the penultimate cycle descaling. Since last second takes the value of Since last after full implementation of a descaling cycle, whereas Since last becomes 0.

**Since third last:** it represents the consumption of water after the antepenultimate cycle descaling. Since last third has the value of Since last second after full implementation of a descaling cycle

**Number of execution:** represents the number of cycles of decalcification performed on C.A .

The submenu "Brewing unit cleaning" has the following items:

**Since last:** it represents the consumption of water after the last cleaning cycle group. Since last assumes the value 0 after the complete execution of the cycle cleaning group.

**Number of execution:** represents the number of cleaning cycles performed group on C.A .

The submenu "Water filter" has the following items:

**Current Number:** Current Number: current number of filter within the process chain longevity. It can range from 0 to 8.

**Remain. Cc to expire:** Autonomy of the filter, so the amount of water in cc remaining before the expiry of the filter.

**Total Filter used:** total number of filters turned on the machine

**Total water cc:** total amount of water, in cc, which has gone through the machine with active filters and unexpired.

**Remain. Cc startup:** counter of the remaining water, expressed in cc, for the activation of the first filter of the chain (1/8) . It goes from 5000 to zero: the first filter must be activated before the counter reaches zero, otherwise it will be necessary to descale before activating the filter.

The item "Water since production" represents the total water consumption, expressed in pulses turbine.

**Max grinder dose**

The item "Max grinder dose" allows you to select the maximum threshold value dose that can take on the grinder. The range of variation of the chosen threshold can vary from 100 to 170.

**Max ground**

The item "Max ground" allows you to select the maximum number of coffee grounds. The range of variation of the number chosen funds can vary from 10 to 20.

5.4. Test mode Expresia Evo

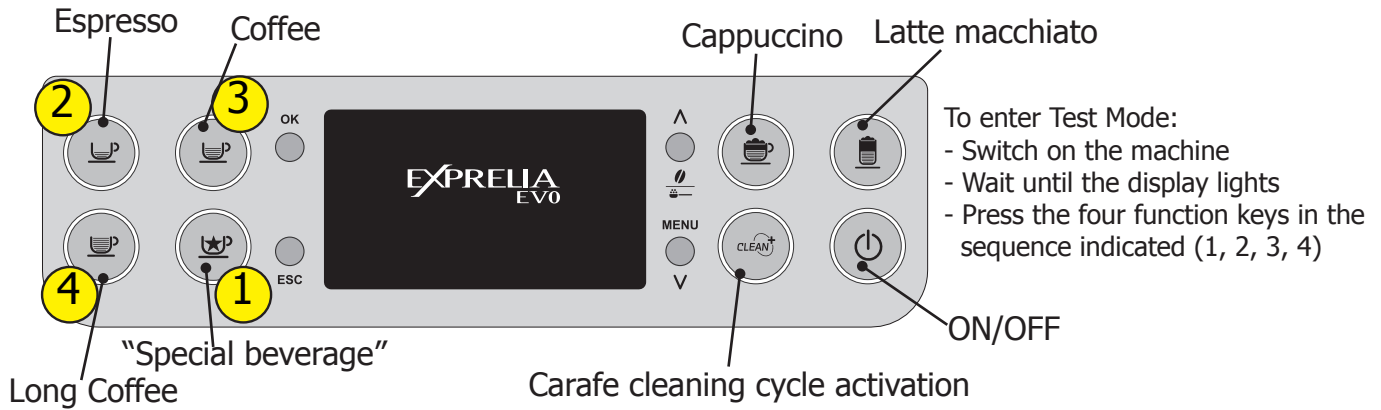

**Description**

When the machine is in Factory Test Mode appears a windows divided in several sectors:

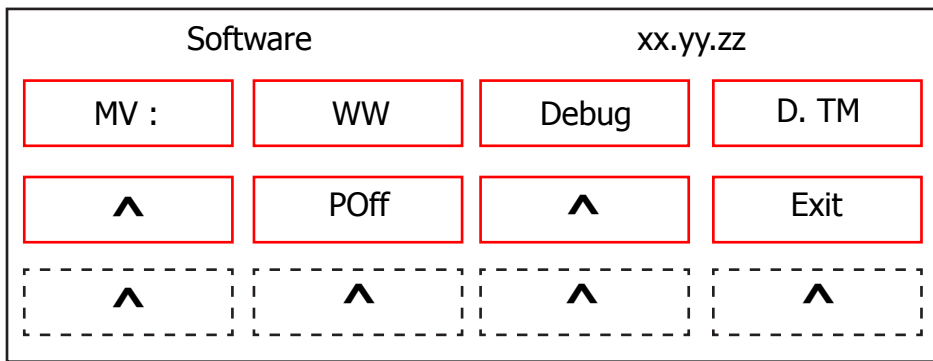

The first row of each window is a title, the red sectors represents the functions (or loads) available to activate or deactivate, the last row is used to show other info. When a function is enabled the corresponding box becomes colored. The dotted sectors is used to show informations about the status of microswitch, sensors or other variables.

The presence of symbol (^) into a sector indicate that no function is associated to.

The following image show the correspondance between the keyboard and red sectors:

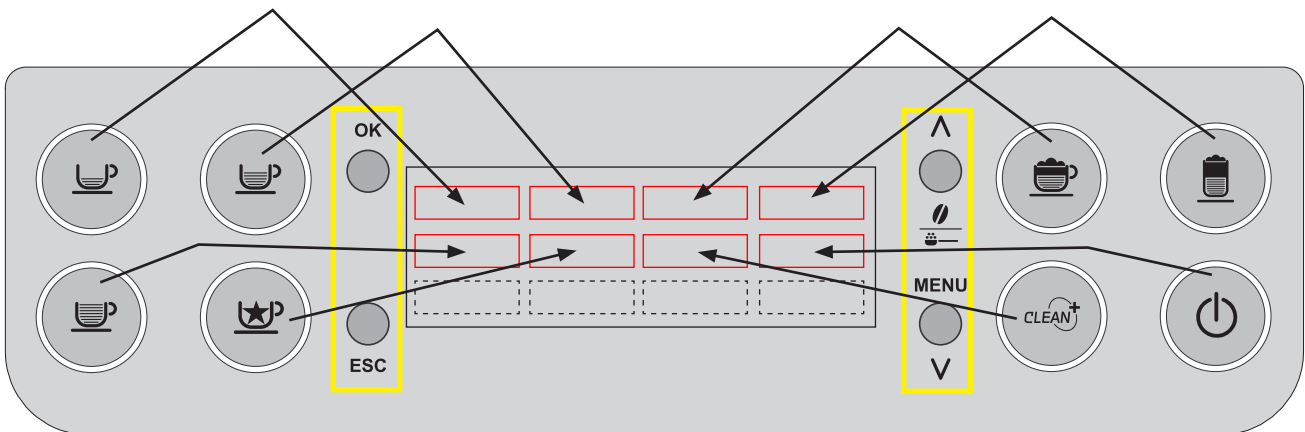

The keyboard buttons (ESC, OK, UP and DOWN), highlighted in yellow, have the following functions:

- UP** : go to next page
- DOWN** : go to previous page
- OK ( )** : confirm / enable / disable function
- ESC ( )** : exit from Factory Test Mode

### Activation of loads

In Test Mode all loads are initially disabled.

To activate a load press the corresponding button on keyboard, to deactivate press again the same button.

Other conditions for which a load may be switched off automatically without key presses are:

- If it is defined a working cycle, when this cycle ends (such as the grinder or brew unit)
- The achievement of a Time-out (Example 5 minuts for boiler)

### Navigation in Test Mode

#### SoftwareVersion

This is the first window of Factory Test Mode. It show the version of CPU software (xx.yy.zz.) , the EEprom version (ww) etc.

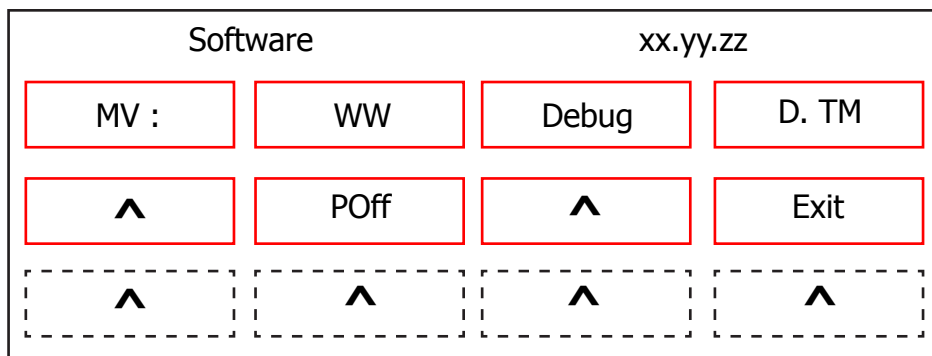

The first two fields in the upper left indicate the version number of EEPROM MV (Memory Version) : ww).

Pressing DOWN will switch you to the next screen. Pressing the POWER ON-OFF mode is exited test

or you can press to exit at any page of the test mode ESC.

#### Commands:

- Debug: if active enables debug messages dell'autodose only for the next reboot
- D.TM: when active enables the possibility of entering the test mode of the display when you reboot machine
- Poff: if activated allows the machine to immediately enter into standby after power from the main switch.

Following the activation of debug messages, the display will be visible the following information:

- Effort of the group at the last grinding
- Actual number of pulses that produced the effort of the brew unit
- Pulse aroma medium after correction dell'autodose following the last grinding

The effort of the brew unit and the actual number of pulses corresponding to it, are available in the display

As soon as the brew unit moves into "work" while impulses aroma medium, correct dall'autodose, are visible when the machine returns to "ready".

Following the activation of debug messages, the display will be visible the following information:

- Effort of the group at the last grinding
- Actual number of pulses that produced the effort of the brew unit
- Pulse aroma medium after correction dell'autodose following the last grinding

The appearance of the display in the ready machine with messages debug actives is as follows:

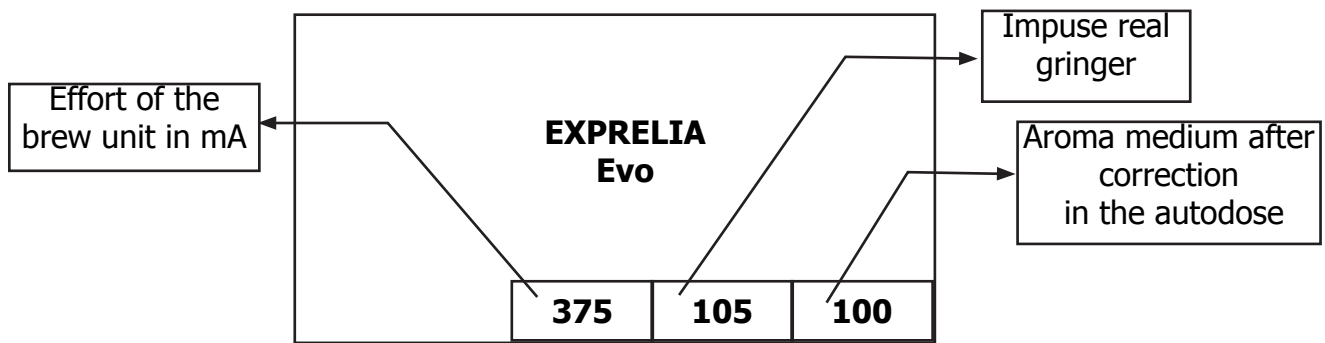





Upon activation of the flag D. TM restarting the machine (eg leaving the test mode) will be possible enter the test mode display by simultaneously pressing: LATTE MACCHIATO AND POWER ON-OFF while filling the bar at StartUp. The complete filling of the bar clears the flag D. TM.

Once in test mode display will appear on the display screen type:



By pressing the ESC key you can exit the display test. Pressing the OK button you can switch from one image to the next test; The test images are the following:

- Image 1  
 All pixels are on
- Image 2  
 Chess board 2x2 pixels
- Image 3  
 Reverse image of 2
- Image 4  
 Concentric circles

After the 4th test image by pressing the OK button reduces the brightness (same as that set for the screen savers). Pressing the OK button again starts from the 1st test image.



## Keyboard

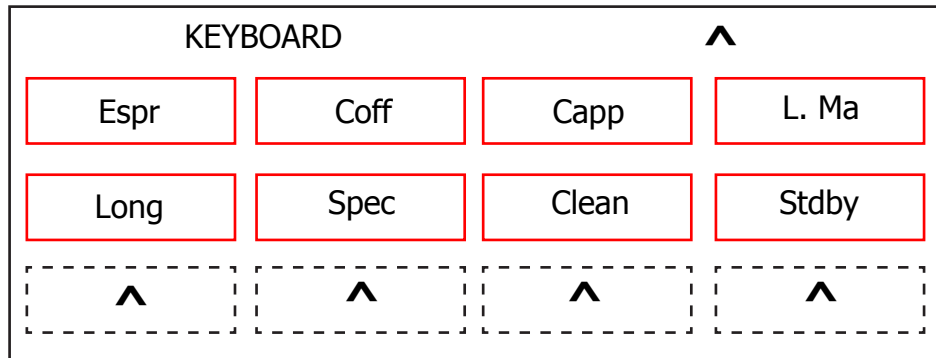

This is the button test page: each beverage corresponds to a box on the display that changes colour when the corresponding button is pressed.

Press **DOWN**  to move to the next screen

## Brew Unit

This screen corresponds to the management of the area inside the front hatch.

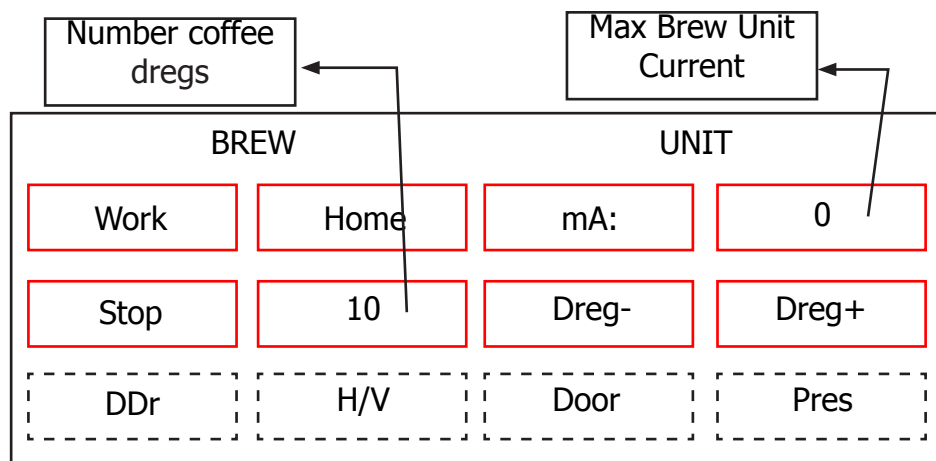

The meaning of the various fields is as follows:

### Operation:

- WORK: if pressed, switches the unit into its work position
- STOP: if pressed, stops the unit instantly
- HOME: if pressed, switches the unit into its Home position
- DREG UP: increases the coffee dregs counter
- DREG DOWN: decreases the coffee dregs counter

### Indicators:

- mA: indicates moment by moment the maximum current (in mA) consumed by the unit when moving. Its value must not exceed 300 mA
- H/W: becomes active (illuminated) when the unit reaches a "Work" position
- Pres: if active, this indicates that the unit is inserted
- DDr: if active, this indicates that the dregs counter is inserted
- Door: if active, this indicates that the front hatch is closed

Press **DOWN**  to move to the next screen

## Hydraulic Circuit

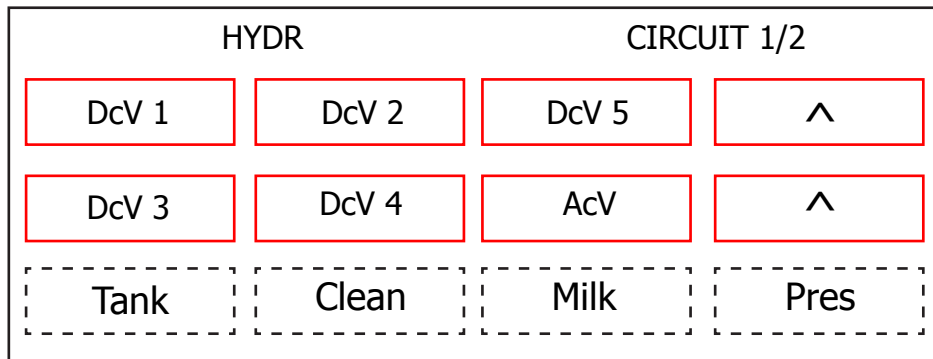

### Operation:

- Ac V: if pressed, activates the 230V solenoid valve
- Dc V1: activates the 24V solenoid valve for draining
- Dc V2: activates the 24V steam dispensing solenoid valve
- Dc V3: activates the 24V milk frothing solenoid valve
- Dc V4: activates the 24V solenoid valve for milk circuit cleaning
- Dc V5: activates the 24V hot water dispensing solenoid valve

### Indicators

- Tank: indicates the status of the water tank level sensor. If activated, the sensor signals that the level has been reached
- Clean: if activated, it indicates that the milk carafe is in the CLEAN position.
- Milk: if activated, it indicates that the milk carafe is in the MILK dispensing position
- Pres: if activated, it indicates that the milk carafe is inserted

Press DOWN  to move to the next screen

## Hydraulic Circuit

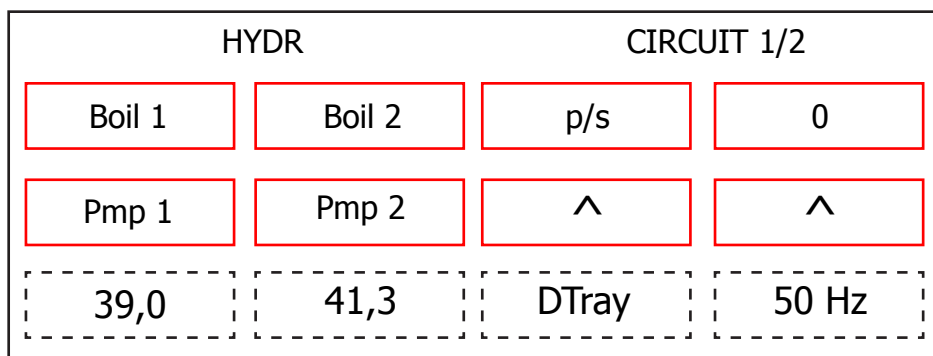

### Operation:

- Boil1: if pressed, this activates the coffee boiler. The boiler is deactivated either by pressing the button again or automatically after 5 seconds. The temperature is indicated in the corresponding window at the bottom
- Boil2: if pressed, activates the steam/hot water boiler. The boiler is deactivated either by pressing the button again or automatically after 5 seconds. The temperature is indicated in the corresponding window at the bottom
- Pmp1: activates the hot water dispensing pump. The pump is switched off by pressing the button once more
- Pmp2: activates the hot water/steam dispensing pump. The pump is switched off by pressing the button once more

**Indicators**

- p/s: indicates moment by moment the water flow rate in the turbine, expressed in pulses per second. When coffee pump 1 is switched on and the coffee solenoid valve is on (AcV on the previous screen) the value must be no lower than 10 p/sec. When hot water/steam pump 2 is switched on and the drain solenoid valve is on (DcV5 on the previous screen) the value must be no lower than 5 p/sec.
- 50 Hz: indicates the mains electricity voltage frequency.
- DTray: indicates the status of the tray level sensor. If activated, the sensor signals that the level has been reached

Press DOWN  to move to the next screen

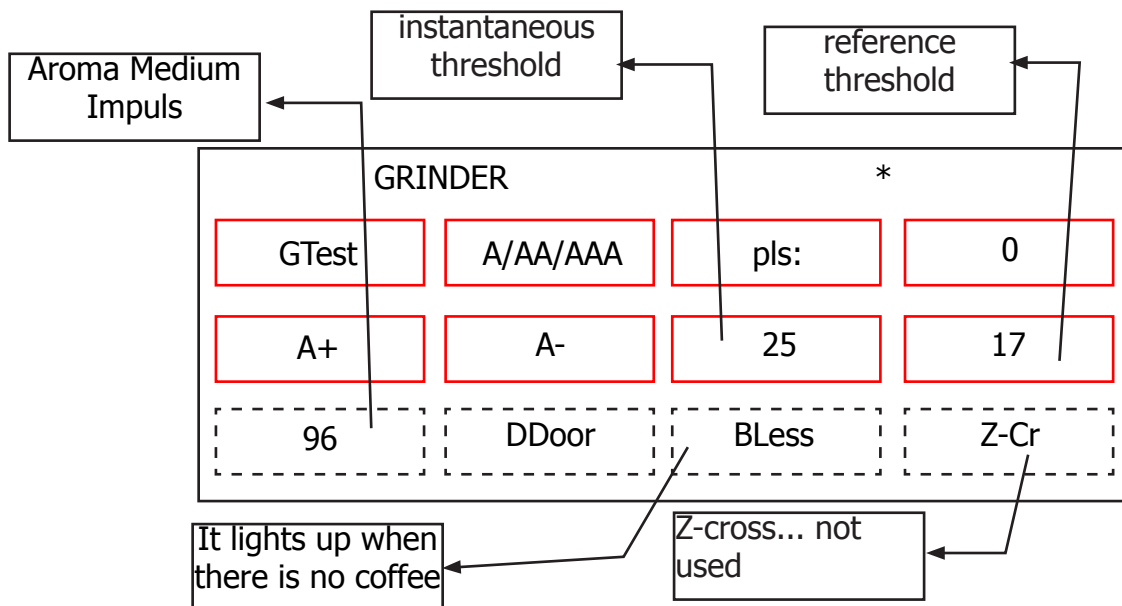
**Grinder****Operation:**

- A/AA/AAA: Selection of the aroma. When pressed it changes the flavor and then the number of pulses of the grinder according to the aroma selected. The symbolism is: A = MILD (lightweight), AA = MEDIUM (medium), AAA = STRONG (strong).
- GTest: if pressed, activates the coffee grinder. To stop it, press the button again. If stopped, the no-coffee test is run. At the end of the test, 2 values will appear in the "instantaneous threshold" and "reference threshold" windows: if "instantaneous threshold" is less than the "reference threshold" the system considers that the coffee grinder is empty

**Indicators:**

- Pls: indicates, during grinding, the real-time grinding pulse countdown
- BLess: This is activated when the system detects there is no coffee. To cancel the alarm you need to raise and lower the bean cover to simulate coffee loading
- BDOOR: indicates the status of the bean hopper door sensor (if active, it indicates that the door is closed)
- A+: increases the number of pulses for a medium aroma
- A-: decreases the number of pulses for a medium aroma
- Z-cr:... not used

The value at bottom left is the number of pulses for a medium aroma: it is modified manually with the "A+" and "A-" keys or automatically by the automatic dosing algorithm

Press DOWN  to move to the next screen

## Display

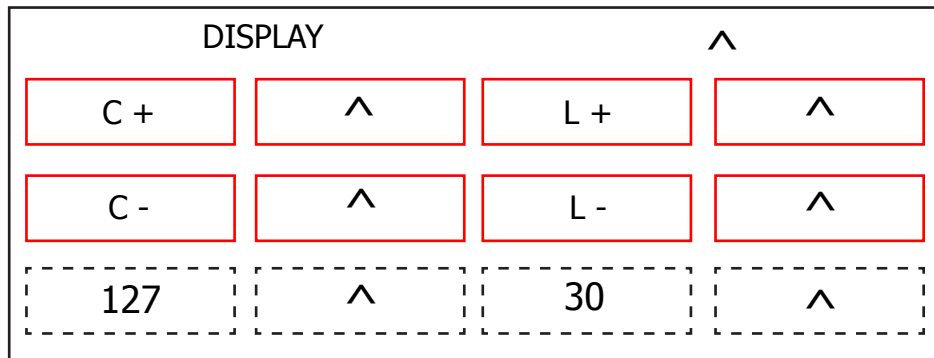

### Operation:

- C+: increases the contrast of the display
- C-: decreases the contrast of the display
- L+: increases the brightness of the display
- L-: decreases the brightness of the display

### Indicators

- The values at the bottom are indices representing the brightness and contrast: in this case these values are not saved to eeprom as they have solely a test function

Press DOWN  to move to the next screen

## 5.5 Steam-out

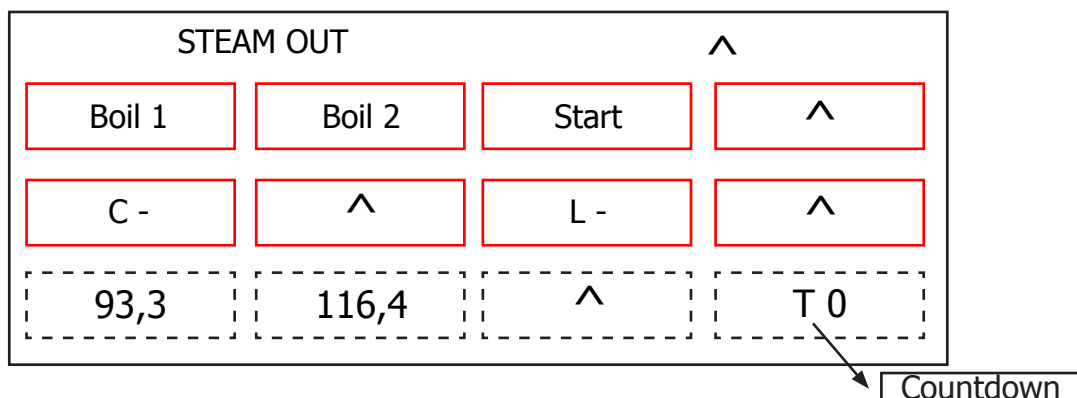

### Operation:

- Boil1: illuminates when the coffee boiler is powered
- Boil2: illuminates when the steam boiler is powered
- Start: starts the draining process

### Indicators:

- The values at the bottom are the temperatures of the two boilers and the countdown (T.O) before the machine requests switching off.

This is the last screen of the Test Mode. Press UP  to go back to the previous screens.

On each screen, pressing ESC exits the TEST mode and restarts the appliance in normal mode.

## 5.6. Diagnostics mode

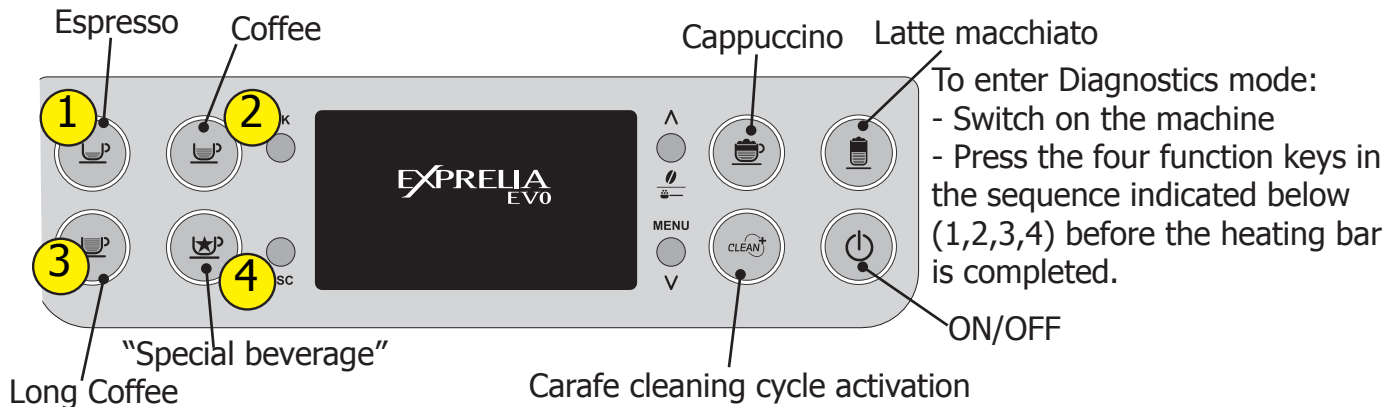

Description of the menu as diagnosis mode.

To enter Diagnostics mode:

- Switch on the machine
- Press the four function keys in the sequence indicated below (1,2,3,4) before the heating bar is completed.

### 1. Product counters

- Espresso
- Caffee
- Caffee lungo
- Hot water
- Cappuccino
- Latte macchiato
- Hot milk

### 2. Error counters

#### 2.1. Error log

- Error code
- Error index
- Error text

#### 2.2. Errors reset

### 3. Water counters

#### 3.1. Descaling cycle

- Since last
- Since second last
- Since third last
- Number of execution

#### 3.2. Brewing unit cleaning

- Number of execution
- Since last

#### 3.3. Since production

#### 3.4. Water filter

- Since last reset
- Number of reset

### 4. Max grinder dose

- $100 \div 170$

### 5. Max ground

- $10 \div 20$

4. Service settings		
1. Product counters	Espresso (value default 0)	
	Coffee (value default 0)	
	Long Coffee (value default 0)	
	Hot water (value default 0)	
	Cappuccino (value default 0)	
	Latte macchiato (value default 0)	
	Hot milk (value default 0)	
2. Error counters	2.1. Errors log (valore di default 0)	Error code
		Error index
		Error text
	2.2. Errors reset	
3. Water counters	3.1. Descaling cycle	Since last (value default 0)
		Since second last (value default 0)
		Since third last (value default 0)
		Number of execution (value default 0)
	3.2. Brewing unit cleaning	Number of execution (value default 0)
		Since last (value default 0)
	3.3. Water since production (valore di default 0)	
	3.4. Water filter	Since last reset (value default 0)
Number of reset (value default 0)		
4. Max grinder dose	100 ÷ 170 (value default 170)	
5. Max ground	Number of reset (value default 0)	

**Detailed description of the menu so diagnosis****Product counters**

"Product counters" represents the number of deliveries carried out by the CA for each product:

Espresso

Caffè

Caffè lungo

Cappuccino

Latte macchiato

Hot water

Hot milk

**Error counters**

"Error counters" displays the total number of errors "out of service" (fail) occurred in the system (see "Errors log"), and allows you to reset the drive (see "Errors reset").

The maximum number of "Fail" count is 20.

The submenu "Errors log" is available only if there is at least one error and, If so, it presents the following information:

- Error code: is the numerical code for the type of fail occurred in the system. For example, "Error code 15" is the error with index 15 and is equivalent the steam boiler timeout.
- Error index: is the numerical position of the error in the internal list. the maximum number of items on the list is 20: the list is handled in a circular fashion, that is, the data in the first place is always the last error occurred in chronological order.
- Error text: is the text description of the type of error that occurred in system. For example: "Boiler steam out".

The cancellation of the error list via "Errors reset", as eliminates all information about them, also prevents access to the submenu "Errors log".

ERROR CODE EXPRELIA	
NOTE	CODE
Grinder blocked	ErrorCode_01
Brewing UNIT blocked work	ErrorCode_03
Brewing UNIT blocked home	ErrorCode_04
Water circuit interrupted	ErrorCode_05
DC valve short circuit	ErrorCode_06
Coffee temp. sensor short circuit	ErrorCode_10
Coffee temp. sensor open circuit	ErrorCode_11
Steam temp. sensor open circuit	ErrorCode_12
Steam temp. sensor short circuit	ErrorCode_13
Boiler coffee timeout	ErrorCode_14
Boiler steam timeout	ErrorCode_15
Brewing unit short circuit	ErrorCode_16
Zero crossing error	ErrorCode_19
Boiler coffee overheating	ErrorCode_20
Boiler steam overheating	ErrorCode_21

**Grinder blocked:** there is the absence of pulses from the grinder.

In this case the C.A. It hangs in the instant in which the user asks the machine to dispense a drink made of coffee (only coffee beans).

**Brewing unit blocked work:** Occurs when the brewing unit can not move from work to the home position.

**Brewing unit blocked home:** Occurs when the brewing unit can not move from home to the work position.

**Water circuit interrupted:** occurs when the flow meter is broken, disconnected or It does not occur passage of water. In these cases, since the C.A. can not correctly read the pulses of water, enters alarm condition "CHARGING CIRCUIT" in the moment in which the user asks to dispense a product: if the "charging circuit" fails C.A. blocked.

**DC Valve short circuit:** occurs when one of the valves of the flute is shorted circuit. Such a problem may occur during dispensing of a product based on milk.

**Coffee temp. sensor short circuit:** occurs when the temperature sensor coffee boiler is shorted. This error causes a blocking in C.A. to start-up.

**Coffee temp. sensor open circuit:** occurs when the temperature sensor coffee boiler is not detected. The problem is due to the absence of the signal of the sensor and does not allow to determine the C.A. the actual temperature of the boiler coffee. At start up, the C.A. blocked.

**Steam temp. sensor open circuit:** occurs when the temperature sensor steam boiler is not detected. The problem is due to the absence of the signal of the sensor and does not allow to determine the C.A. the actual temperature of the boiler steam. At start up, the C.A. blocked.

**Steam temp. sensor short circuit:** occurs when the temperature sensor boiler steam is shorted. This error causes a blocking in C.A. to start-up.

**Boiler coffee timeout:** occurs when no power coming to the boiler coffee, this does not reach the predetermined temperature within a time equal to 200 seconds. At start-up the AC, is continually on the screen HOLD FIRST TEMPERATURE, with the message "Warming up ...", and after the expiry of the time Out to fault

**Boiler steam timeout:** occurs when no power coming to the boiler steam, this does not reach the predetermined temperature within a time equal to 200 seconds.

**Coffee boiler overheating:** occurs when the temperature of the coffee boiler exceeds 150 ° C.

**Steam boiler overheating:** occurs when the temperature of the steam boiler exceeds 170 ° C.

**Brewing unit short circuit:** occurs when the supply of the complete group has in short circuit.

**Zero crossing error:** occurs when the C.A. It does not detect the signal zero crossing.



## Water counters

"Water counters" shows the consumption of water (in pulses) following the granting of products, to the descaling cycle, cleaning cycle, the activation group and filter.

### The submenu "Descaling cycle" has the following items:

**Since last cycle:** is the consumption of water after the last cycle descaling.

**Since second last:** it represents the consumption of water after the penultimate cycle descaling. Since last second takes the value of Since last after full implementation of a descaling cycle, whereas Since last becomes 0.

**Since third last:** it represents the consumption of water after the antepenultimate cycle descaling. Since last third has the value of Since last second after full implementation of a descaling cycle

**Number of execution:** represents the number of cycles of decalcification performed on C.A .

The submenu "Brewing unit cleaning" has the following items:

**Since last:** it represents the consumption of water after the last cleaning cycle group. Since last assumes the value 0 after the complete execution of the cleaning group.

**Number of execution:** represents the number of cleaning cycles performed group on C.A .

The submenu "Water filter" has the following items:

**Since last reset:** this is the consumption of water after the last cycle filter activation. Since last reset takes the value 0 after the complete execution of the activation cycle filter.

**Number of reset:** represents the number of activation cycles performed filter on C.A .

The item "Water production since" represents the total water consumption in liters.

## Max grinder dose

The item "Max grinder dose" allows you to select the maximum threshold value dose that can take on the grinder.

The range of variation of the chosen threshold can vary from 100 to 170.

## Max ground

The item "Max ground" allows you to select the maximum number of coffee grounds. The range of variation of the number chosen funds can vary from 10 to 20.

# **CHAPTER 6**

## **STANDARD INSPECTIONS**

## 6.1. Repair Flow

Proces stap	Saeco no.	Action
<b>Intake</b>	1	Visual inspection (transport damage) take care for pictures
	2	Check Type/serialnumber
		Log all available accessory
<b>Diagnosis</b>	3	Check product for consumer complaint (NFF contact consumer)
	4	Opening machine
	5	Visual inspection check for loosen parts, leaking etc..
	6	Operational tests
<b>Repair</b>		Run Diagnostic to get error codes and relevant set statistics (Saeco Service Center SSC)
	7	Repairing the faults encountered
	8	"Checking any modifications (view Symptom Cure, new software, etc.) Refer Annex tabs per family"
	9	Service activities in accordance with the operating schedule
		Check/Replace Waterfilter (the small filter, not the Britta filter)
		Check/Replace Water tank lip seal
		Check/Replace Boiler pin O-ring
		Clean/align Coffee grinder (Vacuum cleaner / brush)
		Descale the water Circuit
		Check/Replace Hot water/steam valve
	10	Internal check / cleaning
		Check/Clean/Grease Brewing unit
	11	Operational test while the appliance is open
		Check Hoses, attachments and Oetiker clamps
	Check Pump for operation & noise	
	Check Gear motor for operation & noise	
	Check for leakage	
12	Assembly	
13	Final inspection test	
14	Steam out before shipping out, if temperature is below 0° to prevent any damaged due to frozen water	
<b>Inspection</b>		
<b>visual</b>		Do cabinet parts fit well together
		Check for damages
<b>Power check</b>		Will the set switch on
<b>Accessoires</b>		Do the accessories match with the intake
<b>Consumer complaint</b>		Check the product for the consumer complaint
<b>Coffee</b>		
<b>Dispense</b>		Make 2 * coffee. Are both amounts equal
		Make e 2 cups at the same time. Are the volumes equal

Noise		Is the sound normal
Crema		Blow on the coffee. Does the crema come back together
		Is the crema colour correct (Hazelnut)
Temperature		Is the coffee temperature within spec
Grinder		Is the grinder noise normal
Steam		
Steam		Does the steam work
Hot Water		Does the hot water work
Milk		(if applicable)
Cappuchino		Does the cappuccinatore produce good froth
Leakage		
Leakage	14	Did the product leak during the testing
	15	Draining the circuit (in winter)
Cleaning		Clean water reservoir, bean reservoir, brew chamber and conveyor
	16	Clean and dry brew unit, coffee bin and drip tray.
		Lubricating the brewing unit with suitable grease
		External cleaning
Safety check		
		Earth leakage, Isolation test, resistor of earth wire grounding, as requested in certain country's (VDE, ISO)
visueel		Check the mains cord for damages
Packing		
	18	Packing
		Check completeness (accessories) according income log
	19	Neatly pack the product
Documentation		NFF letter
		Descaling instruction with changed procedure (S/C)
		Other instructions according S/C
Repair report		Is there an answer to ALL consumer questions/complaints (see complaint)
		add set statistic and give, if needed clear instruction towards consumer
		Is it indicated which documents are added
		Are there tips how to prevent issues

# **CHAPTER 7**

# **DISASSEMBLY**

7.1. Outer elements



Remove the cover and water tank, the coffee container cover, the water drip tray, the coffee dispenser.

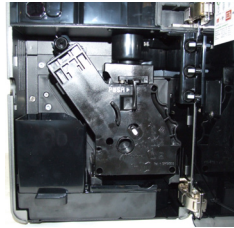

Remove Brew Unit and and Drip Tray inside the door



Loosen the screws shown and release the cover by moving it outside and lifting it.



Remove the PW cover, loosen the screws shown and and remove the frames.

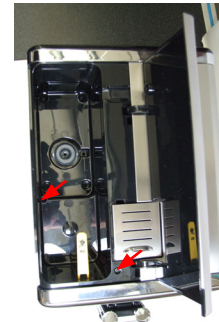

Loosen the screws shown in the upper cover



Release the top cover as images and lift.

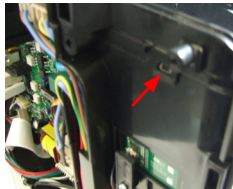

Remove the electrical connection.

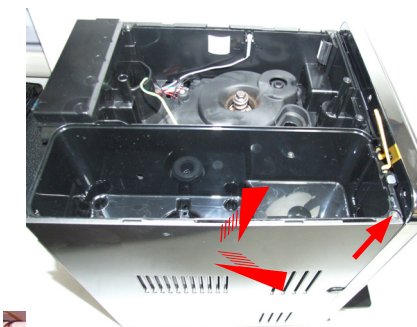

Loosen the screws shown and remove the side protections

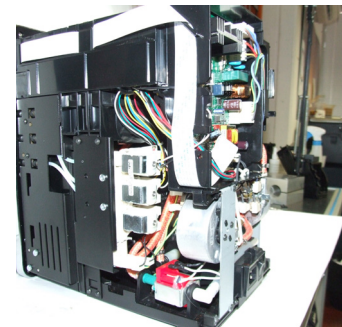
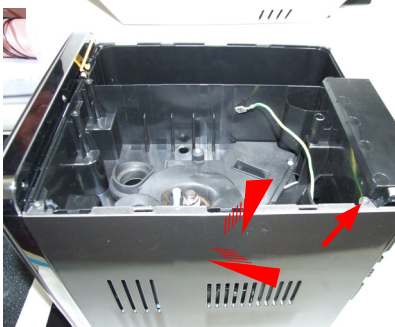



## 7.2. Coffee grinder

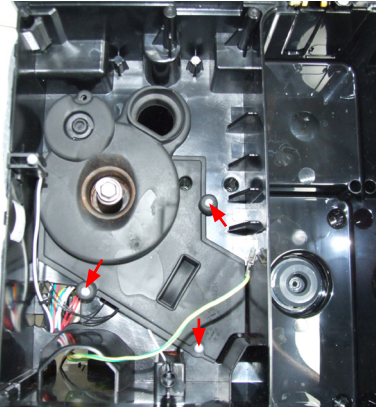

Loosen the screws as shown and remove the sound insulating cover of the coffee grinder

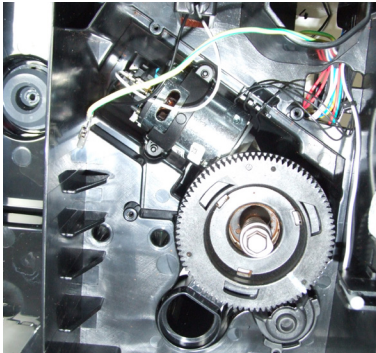

Lift the coffee grinder

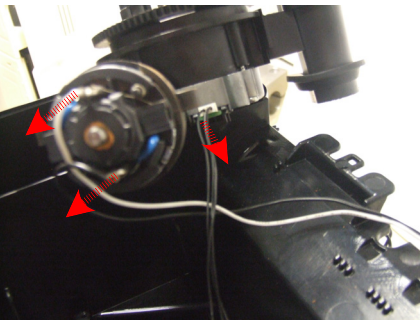

Remove the connections shown



When reassembling the coffee grinder, make sure the spring is repositioned correctly (see picture)

### 7.3. Grinder blades

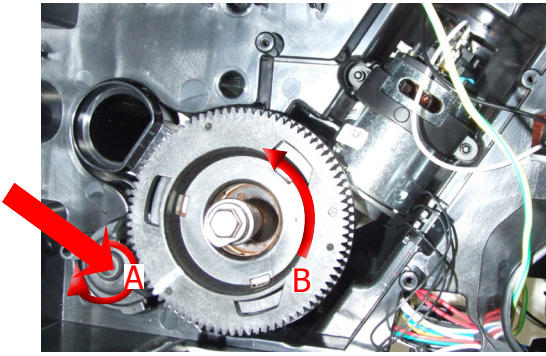

To extract the top support of the appliance, press on the grinding adjustment spindle (A) and turn the support anticlockwise until it unhooks.

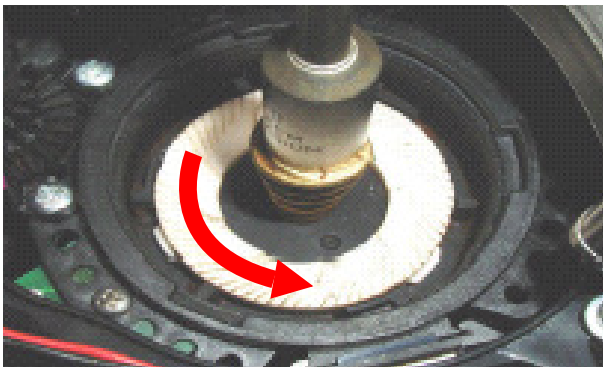

Turn the grinder blades anticlockwise from the support.

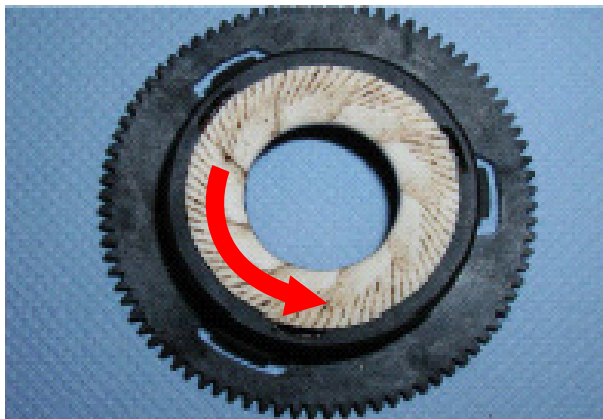

Turn the grinder blades clockwise from the support. The bayonet fittings can be accessed from the rear.

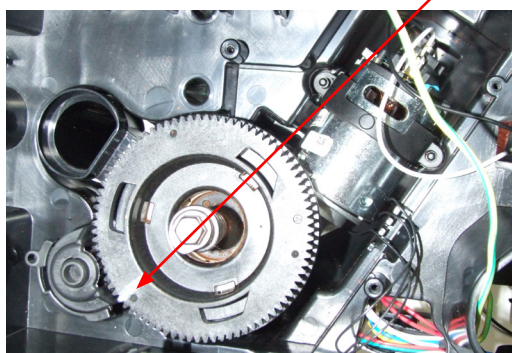

For a standard adjustment, both markings must be aligned.



### 7.4. Coffee grinder adjustment

The grinding machine can be adjusted by the user (only with the grinding machine on) by pressing and turning the knob inside the coffee bean container one notch at a time

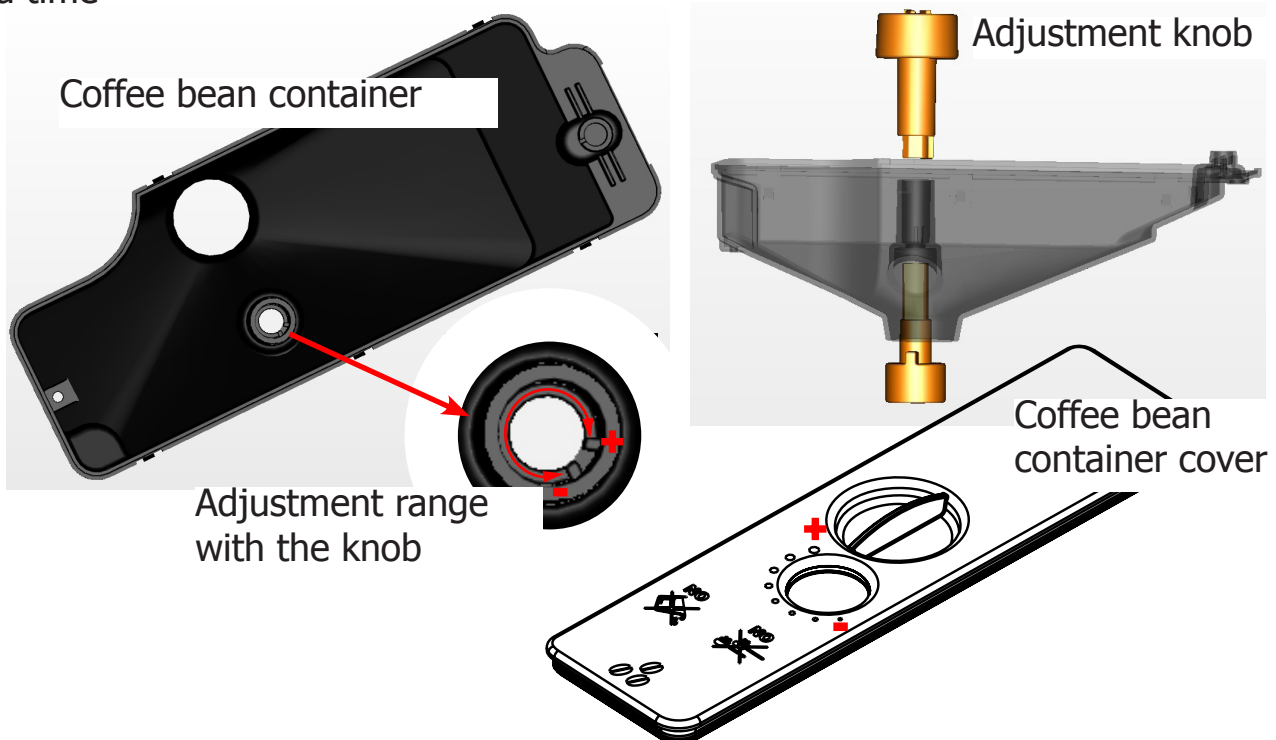

### Adjustment implemented by the assistance centres

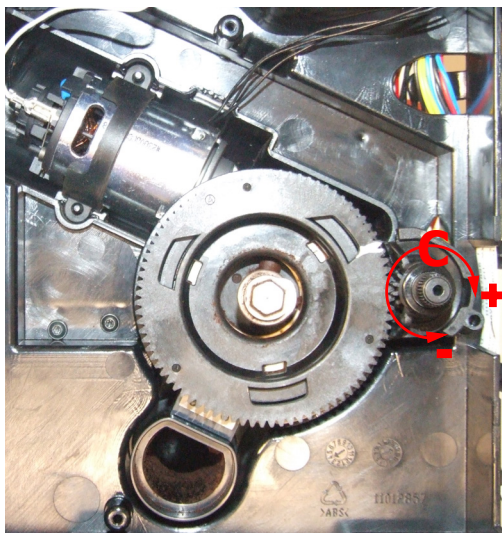

To further adjust the grinding machine, the technician can operate directly on the machine by pressing and turning the highlighted ring nut (C) (clockwise + to increase the grain size and anti-clockwise - to decrease it)

If coffee residue is found between the two grinder blades, it is recommended to adjust this by tightening a max of two notches at a time.

Lastly, bring the arrow (A) on the adjustment knob back to the centre of the adjustment dots on the cover (B).

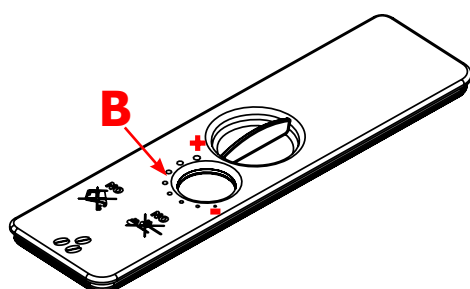

EVO 2

### 7.5. Steam pump

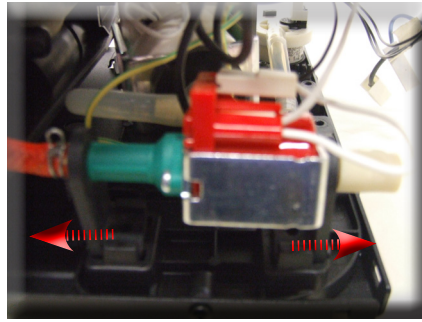

Remove the two pump supports (highlighted) anchored to the structure and disconnect the electrical and water connections

### 7.6. Coffee pump

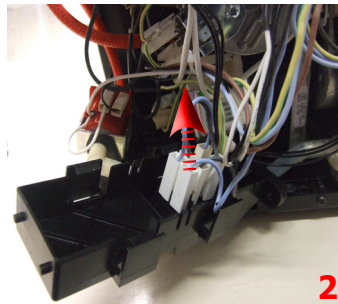
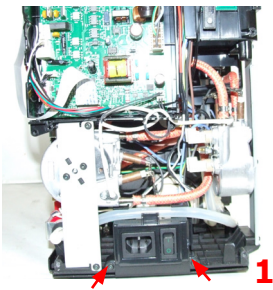

- 1) Loosen the screws as shown
- 2) Remove the connections from the component support. This process facilitates removing several components (coffee pump, boiler, etc.)

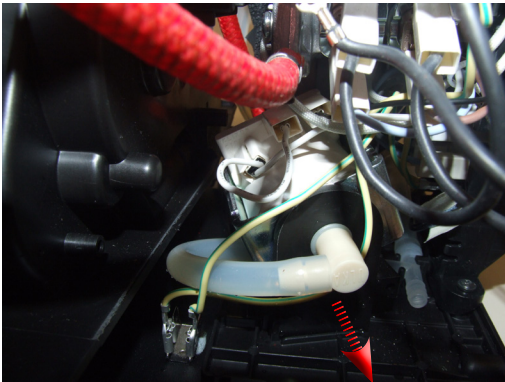

Remove the two pump supports (highlighted) anchored to the component support and disconnect the electrical and water connections

### 7.7. Flow meter

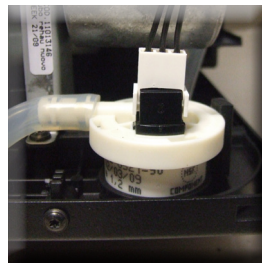
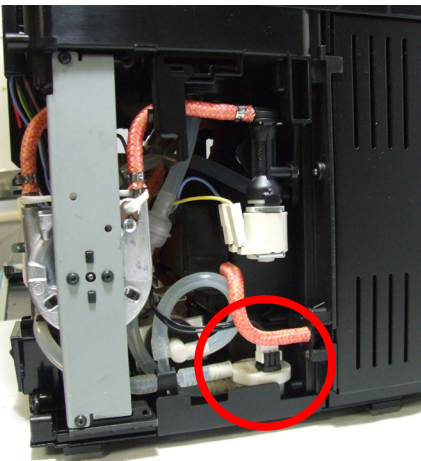

Lift the flow-meter from the component support and remove the electrical and water connections

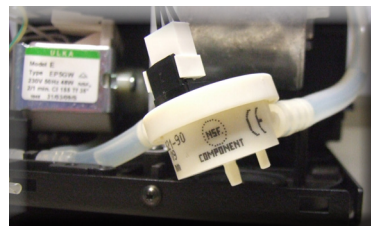



**7.8. Power Board**



Remove the board cover

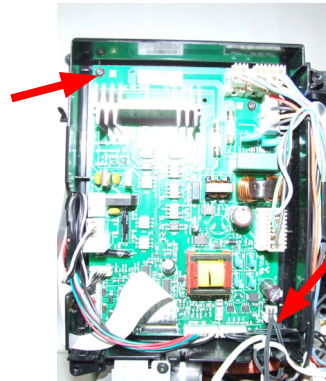

2) Loosen the screws as shown and remove all the electrical connections

**7.9. Steam boiler**

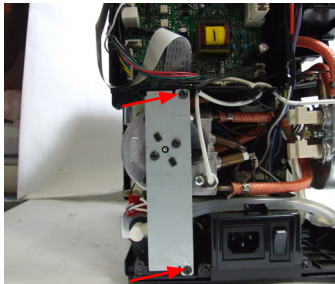

Remove the screws as shown and the component support

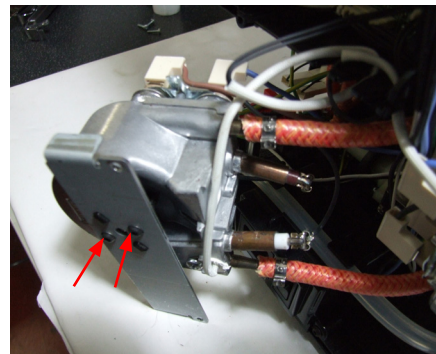

Loosen the screw as shown and remove the electrical and water connections

**7.10. Coffee boiler**

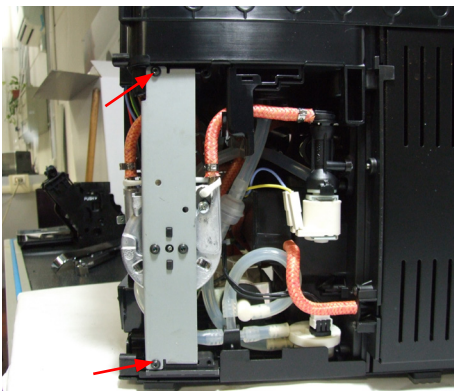

Remove the screws as shown and the component support

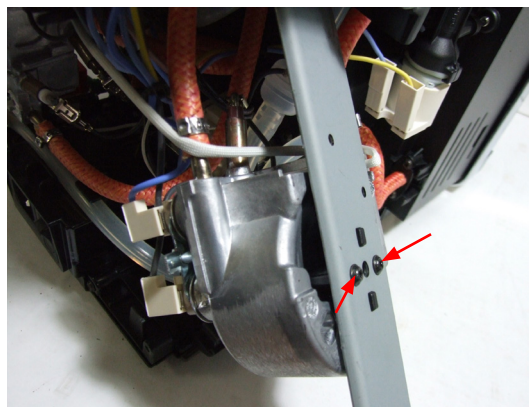

Loosen the screws as shown, remove the boiler assembly support and the electrical and water connections

## 7.11 Gearmotor

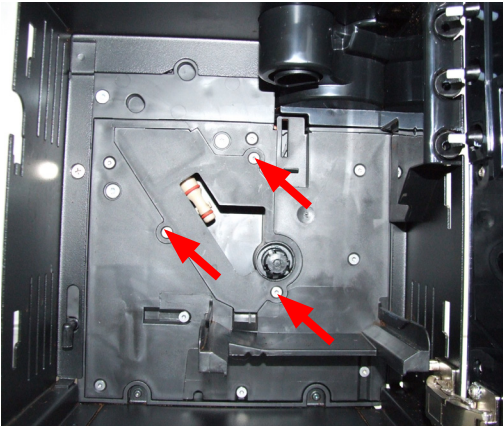

Loosen the screws as shown and remove the boiler pin

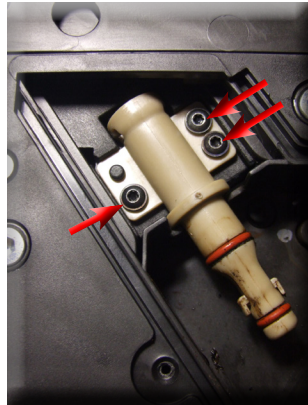

Loosen the screws as shown and remove the boiler pin

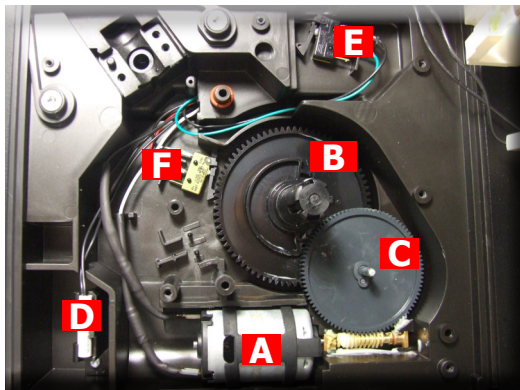

The following are located inside the compartment protected by the casing:

- The electric motor (A) with gears (B) and (C) for transmission and timing of the dispensing unit.
- The dreg drawer presence sensor (D).
- The dispensing unit presence microswitch (E).
- The microswitch (F) that detects the idle phase of the dispensing unit as well as that of the dispensing process.
- Remove the gear (C) that engages with the motor transmission shaft motor transmission.
- Remove the large gear (B).
- Remove the motor (A) complete with the transmission shaft.

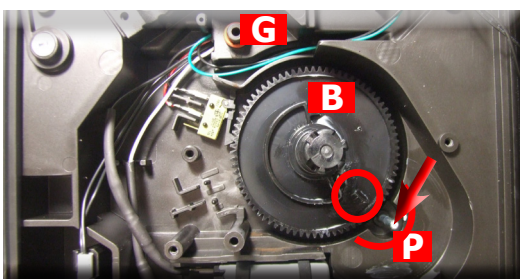

- (G) Drain multi-way valve.

Reconnect the gear (B), making sure that the arrow is aligned with the opening that contains the pin (P).

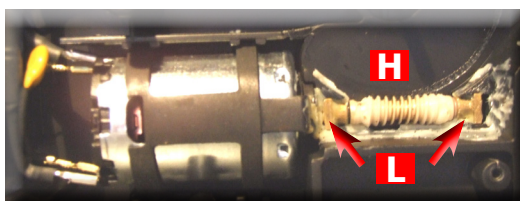

When re-mounting the motor and the transmission shaft, make sure the guides (L) are inserted in the correct housing.

Grease the shaft thoroughly and evenly.



**7.12. Frother valve assembly**

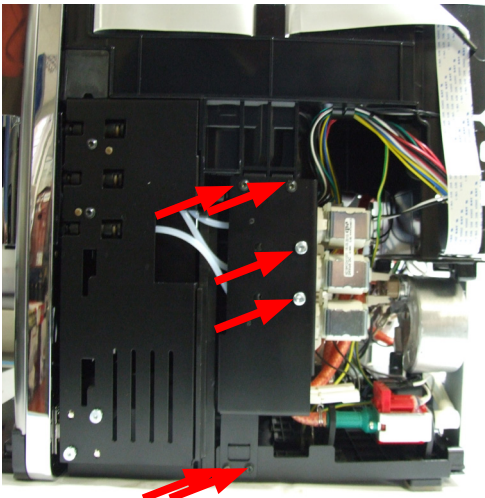

Loosen the screws as shown and remove the frothing valve

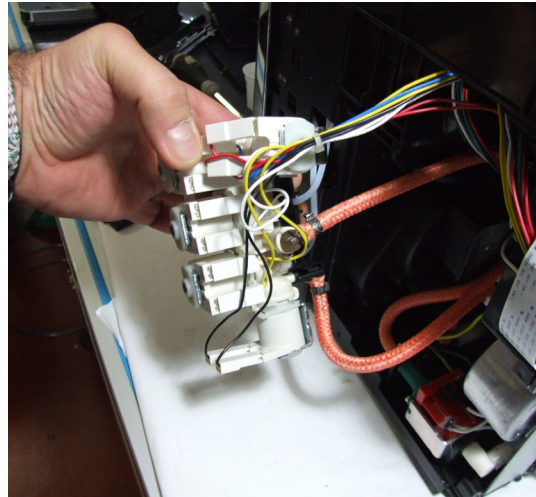

Disconnect the electrical and water connections

**7.13. Dispenser assembly**

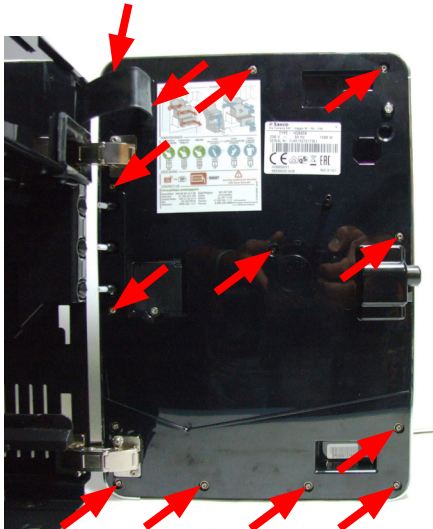

Loosen the screws as shown to remove the inner cover of the front panel

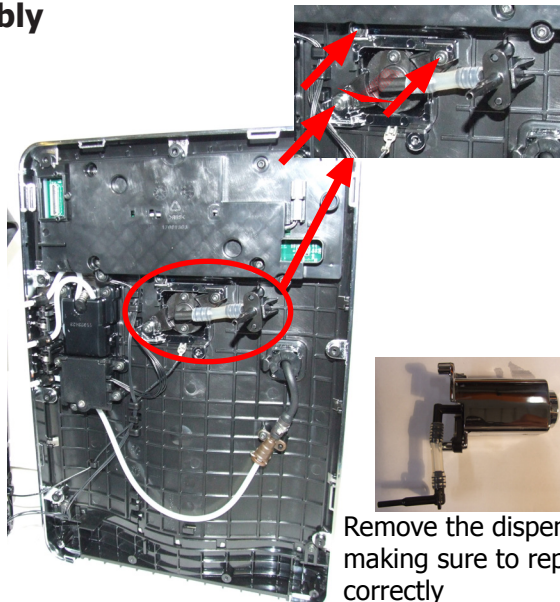

Loosen the screws as shown and remove the coffee dispenser assembly (picture A)

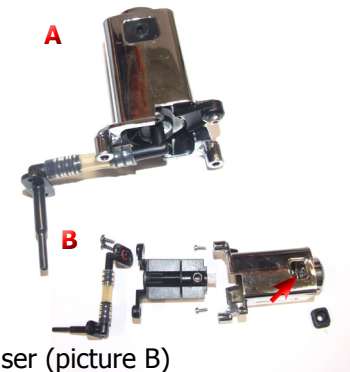
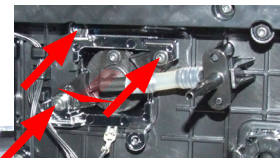

Remove the dispenser (picture B) making sure to reposition the highlighted spring correctly

**7.14. CPU Water level Sensor**

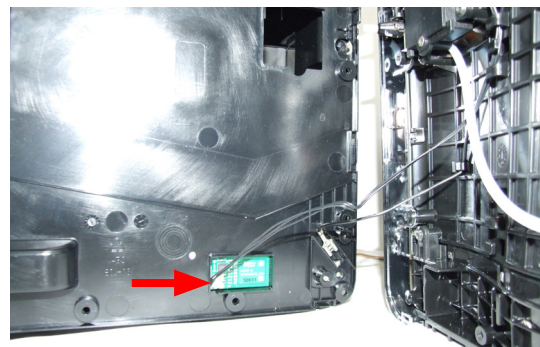
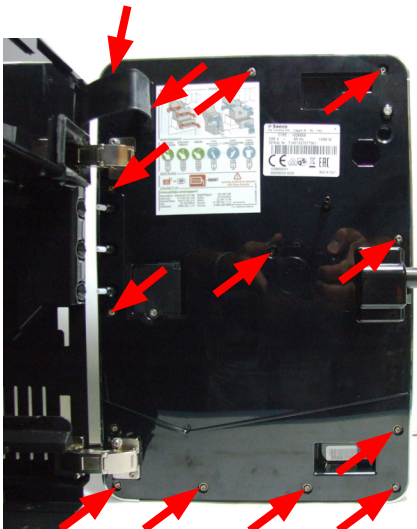

Loosen the screws as shown to remove the inner cover of the front panel and disconnect the electrical connections

**7.15 Steam pipe assembly**

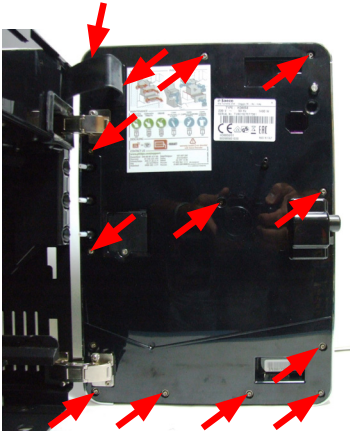

Loosen the screws as shown to remove the inner cover of the front panel

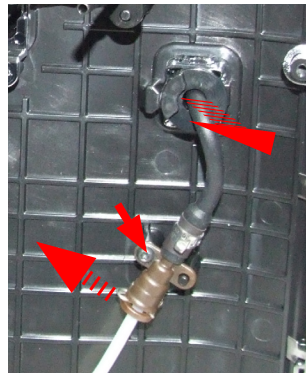

Loosen the screw and remove the steam pipe and disconnect the pipe from the Teflon by removing the fork

**7.16. Teflon pipe support and carafe fitting assembly**

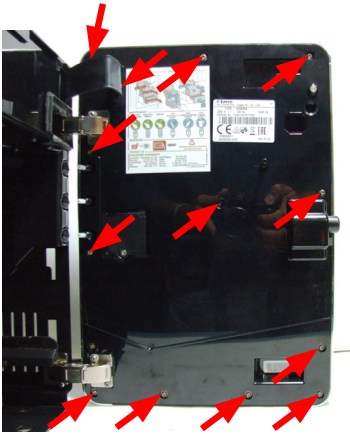

Loosen the screws as shown to remove the inner cover of the front panel

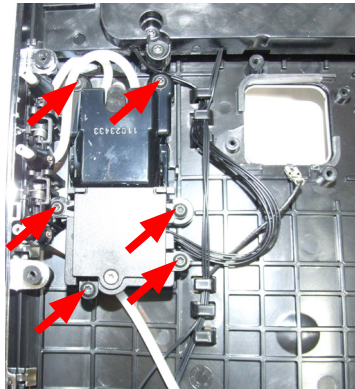

Loosen the screws as shown and the Teflon pipe support cover from the carafe

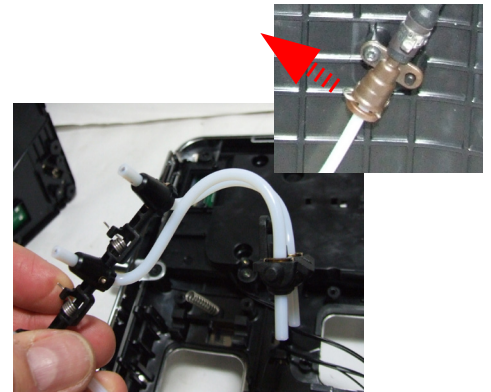

Disconnect the pipe from the Teflon by removing the fork and remove the Teflon pipe support assembly

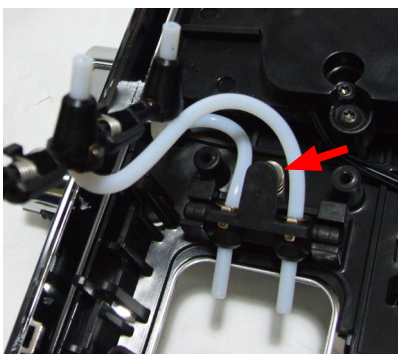

When re-mounting it, make sure to reposition the spring correctly

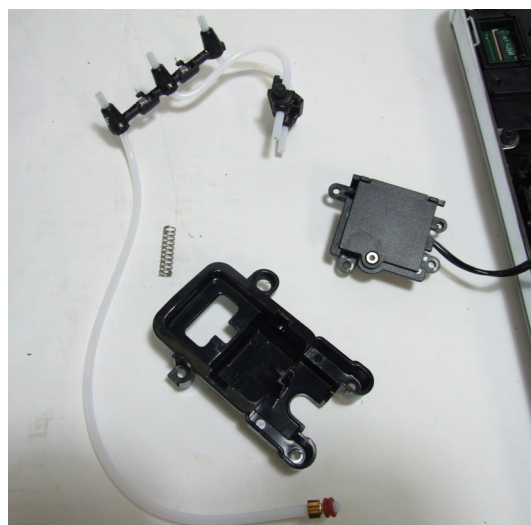



7.17 Carafe board general assembly

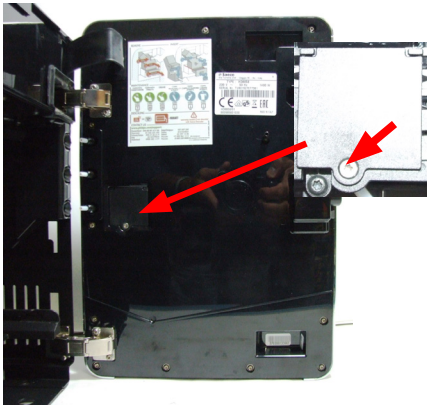

Loosen the screw as shown

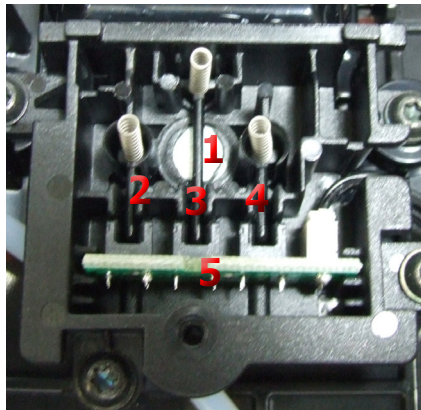

- 1) Magnet to improve carafe adherence to the door
- 2,3,4) Carafe presence and position sensors
- 5) Carafe board

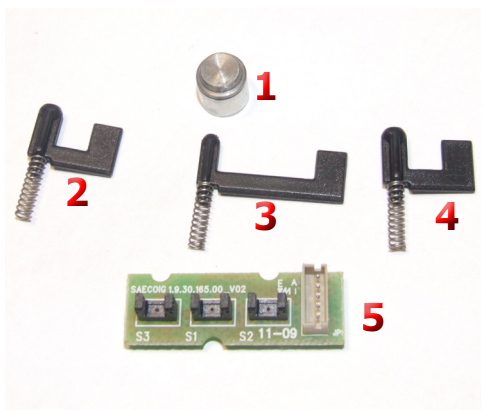

7.18 CPU board, display and front panel

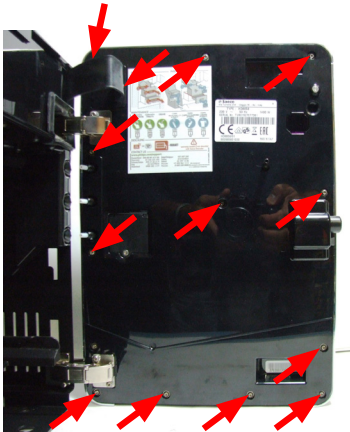

Loosen the screws as shown to remove the inner cover of the front panel

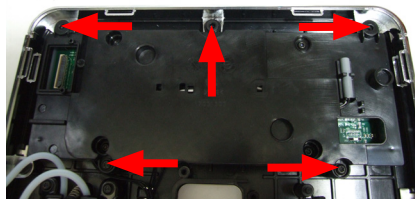

Loosen the screws as shown and remove the CPU board assembly

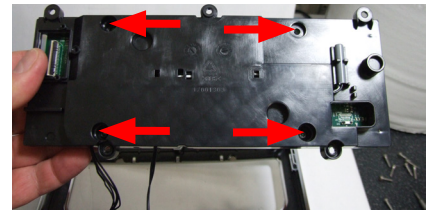

Loosen the screws as shown and remove the cover



### 7.19. Un/installing Oetiker clamps

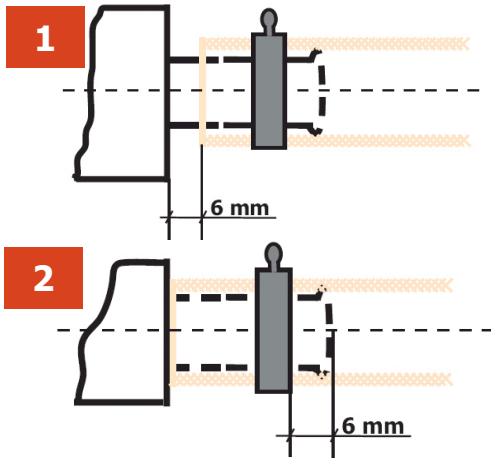

1) Boiler connection

2) Other connections



### Replacing the pipes

1) Use a suitable pair of pliers to remove the clamp (as shown in the picture)



2) Tighten the clamp as shown in the pictures



# CHAPTER 8

## NOTES



## **CHAPTER 9**

# **WATER CIRCUIT DIAGRAM**



# **CHAPTER 10**

# **ELECTRICAL DIAGRAM**

