

Service Service Service

GranBaristo
Avanti V2



GranBaristo V2



GranBaristo
Avanti



GranBaristo



Service Manual

Rev. 05 MAY 2016

TECHNICAL INFORMATION

Power supply and output:	240 V~ 50 Hz 1900W - 230 V~ 50/60 Hz 1900 W 120 V~ 60 Hz 1300 W
Temperature monitoring:	(NTC) variable resistor sensor - transmits the value to the electronic card
Safety system:	2 thermostats at 190°C one shot
Coffee heat exchanger output: Stainless steel for coffee, hot water and steam dispensing	(230 V~) 1900 W - (120 V~) 1300 W - (100 V~) 1100 W
Dimensions: W x H x D in mm:	210 x 360 x 460 mm
Stand-by power consumption	< 0,5W
Weight:	13 kg
Water tank capacity:	1.7 l
Coffee bean hopper capacity:	270 g. of coffee beans
Dreg drawer capacity:	20
Heating time:	Approx. 45 sec.
Water circuit filling time:	Approx. 15 sec Max. on first filling cycle
Power consumption:	During heating phase- approx. 5.6 A
Automatic dosage:	Dose adjustment controlled by the electronic system
Material	
Housing	ABS/ABS+PMMA/METAL
Beans container	ABS
Water tank	SAN
Dreg drawer	ABS

All parts of this document are the property of Saeco International Group.

All rights reserved. This document and all the information herein is provided without liability deriving from any errors or omissions. Furthermore, no part may be reproduced, used or collected, except where express authorisation has been provided in writing or through a contractual agreement.

GRAN BARISTO

Table of contents		Page	Table of contents		Page
1.	Introduction		5.	Service Mode	
1.1.	Documentation required	1	5.1.1.	Test Mode Gran BaristoV2 and AvantiV2	1
1.2.	Tools and equipment required	1	5.1.2.	Diagnostic Mode Gran BaristoV2 and AvantiV2	8
1.3.	Material	1		Test Mode in GranBaristo Avanti	
1.4.	Safety warnings	1	5.1.3.	Error codes	12
1.5.	Service Policy	2	5.2.1.	Test Mode in GranBaristo Avanti	13
1.6.1.	External machine parts GranBaristo V2	3	5.1.3.	Disagnostic Mode in GranBaristo/GranBaristo Avanti	18
1.6.2.	External machine parts GranBaristo	4	5.2.2.	Test Mode Gran Baristo	20
1.6.3.	Internal machine parts	5	5.2.3.	Diagnostic Mode Gran Baristo/Gran Baristo Avanti	26
			5.2.4.	Error codes	30
2.	Technical specifications		5.3.	Saeco Service Center - Quick Start Guide	30
2.1.	Technical specifications	1	6.	Service and Maintenance	
2.2.1.	Specification for the measurement of the coffee products temperature	2	6.1.	Repair flow	1
2.2.2.	Specification for the measurement of the Milk products temperature.	3	7.	Disassembly	
2.3.	Machine parameters and performance GranBaristo V2	5	7.1.	Outer Shell in Gran Baristo and GranBaristo V2	1
2.4.	Machine parameters and performance GranBaristo	6	7.2.	Service door	3
2.5.	How to Check for oil leakage in piston assembly.	7	7.3.	Coffee grinder	3
3.	Brief instructions		7.4.	Grinder blades	4
3.1.1.	Customer menu in the Gran Baristo BaseV2 and AvantiV2	1	7.5.	Coffee grinder adjustment	5
3.1.2.	Customer menu in the GranBaristo Avanti	3	7.6.	Solenoid valve and assembly drain valve	5
3.1.3.	Customer menu in the GranBaristo	6	7.7.	The piston assembly	6
4.	Operating logic		7.8.	Pin boiler	6
4.1.1.	Water circuit GranBaristo	1	7.9.	Termostat	6
4.1.2.	Milk carafe	2	7.10.	Pump	7
4.2.	Coffee cycle	3	7.11.	Flow-meter	7
4.3.	Single microswitch	4	7.12.	Gearmotor and Microswtch present BrewUnit	7
4.4.	Temperature sensor	4	7.13.	CPU board and KYB interface and display	9
4.5.	Coffee grinder	5	7.14.	Bluetooth board in GranBaristo Avanti	10
4.6.	Water level detection (water tank)	5	7.15.	Fitting and removing Oetiker clamps	10
4.7.	Descaling request	6	8.	Notes	
4.8.	Water filter GranBaristo and GranBaristo Avanti	6	9.	Water circuit diagram	
4.9.	AquaClean water filter GranBaristo V2 and GranBaristo Avanti V2	7	10.	Electrical diagram	

MODIFICATIONS TO SERVICE MANUAL				
GranBaristo V2 and GranBaristo Avanti V2 (from sn Tu901540118687 only 230v version)				
From Rev.	To Rev.	Chapter	Inserted	Modified
Rev.04	Rev05	01		Par. 1.3. Material
		04		Par. 4.9. Inserted code AquaClean water filter
		05	Par. 5.3. Saeco Service Center - Quick Start Guide	
		06		Par. 6.1. Repair flow

CHAPTER 1

INTRODUCTION

1.1 Documentation required

The following documentation is needed for repair procedures:

- Instruction booklet for specific model
- Technical documentation for specific model (diagrams, exploded view, symptom cure and service manual)

1.2 Tools and equipment required

As well as the standard equipment, the following is required:

Qty.	Description	Notes
1	Screwdriver	
1	Pliers for Oetiker clamps	
1	CC -A - Vdc tester	
1	Digital thermometer	Scale limit > 150°C
1	SSC (Saeco Service Center)	Programmer (for programming and diagnostics mode)

1.3 Material

Material	Code and Description
Thermal paste	Heat resistance > 200°C
Descaler	21001901 "ACC SAE DECALCIFIER 5 L 1 UNIT"
Grease solvent	132253695601 "PARALIQ GB 363"
Silicone grease	14-INTGR22004 "ACC TUBE FIN FOOD GREASE 2 400 ML"

1.4 Safety warnings

We recommend you consult the technical manual of the machine before performing any maintenance work.

Observe all applicable standards relating to the repair of electrical appliances.

Always disconnect the power plug from the mains before beginning repair work.



Simply turning off the main machine power switch is not an adequate safety precaution.

This domestic appliance is rated as insulation class I.

On completion of the repair work, insulation and dielectric rigidity tests must be performed.



Disassembling the machine, the operator must pay attention to hot and under Pressure parts: boiler, pin-boiler, valves, dispensing, steam tube, brew unit, connections and pipes to avoid burns. Please refer to specific hydraulic circuit (Image1) to know the parts in detail.



The machine hydraulic circuit can reach maximum pressure of 16/18 bar.

To operate in safety condition is recommended to perform the Steam Out procedure in order to remove the pressure and hot water inside the hydraulic circuit.

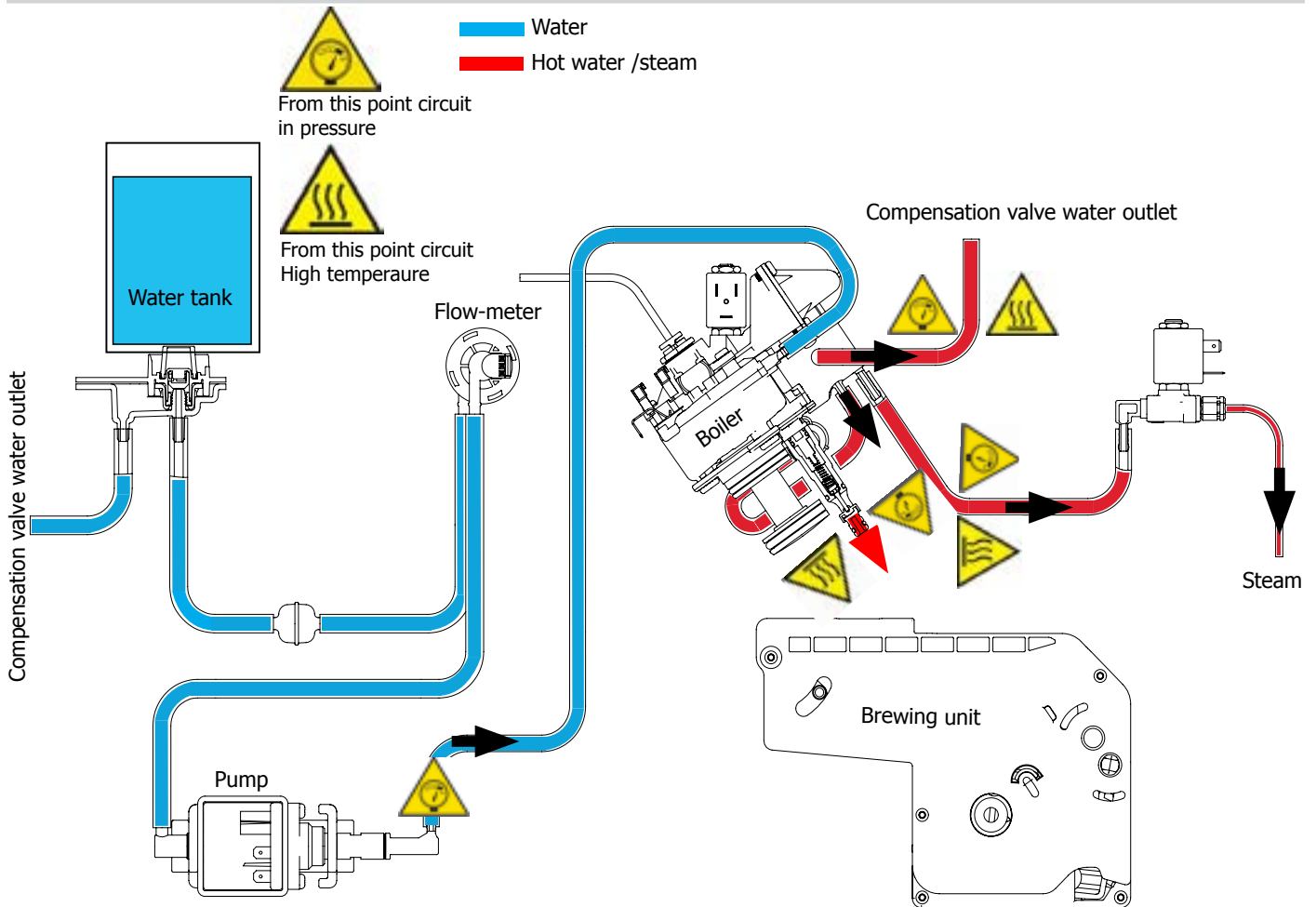

1.5 Service POLICY grid as used for coffee machine

For **IN WARRANTY** repairs is recommended to use when and where possible the single components, available in the exploded views of the coffee machines or of the specific components. If you find the information "SEE THE EXPLODED VIEW E....." in the assembly description field, it means that the single components of the assembly are available in the other pages of the exploded view. It's possible to use the assembly only if there is a specific Symptom Cure that include this possibility or when the single components are not available for the order.

List of principal assembly present in all our coffee machines

Components	Assembly use	Single components available
COFFEE GRINDER	<u>Only for OOW repairs</u>	YES , to consult the specific exploded-view of the machine or of the Coffee Grinder on website
BREWING UNIT	<u>Only for OOW repairs</u>	YES , to consult the specific exploded-view of the machine or of the Brewing unit on website
PISTON UNIT ASSY.	<u>Only for OOW repairs</u>	YES , to consult the specific exploded-view of the machine on website
GEAR MOTOR	<u>Only for OOW repairs</u>	YES , to consult the specific exploded-view of the machine on website
FILTER HOLDER	<u>Only for OOW repairs</u>	YES , to consult the specific exploded-view of the machine on website
MILK CARAFE	<u>Only for OOW repairs</u>	YES , to consult the specific exploded-view of the machine on website

1.6.1 External machine parts GranBaristo V2

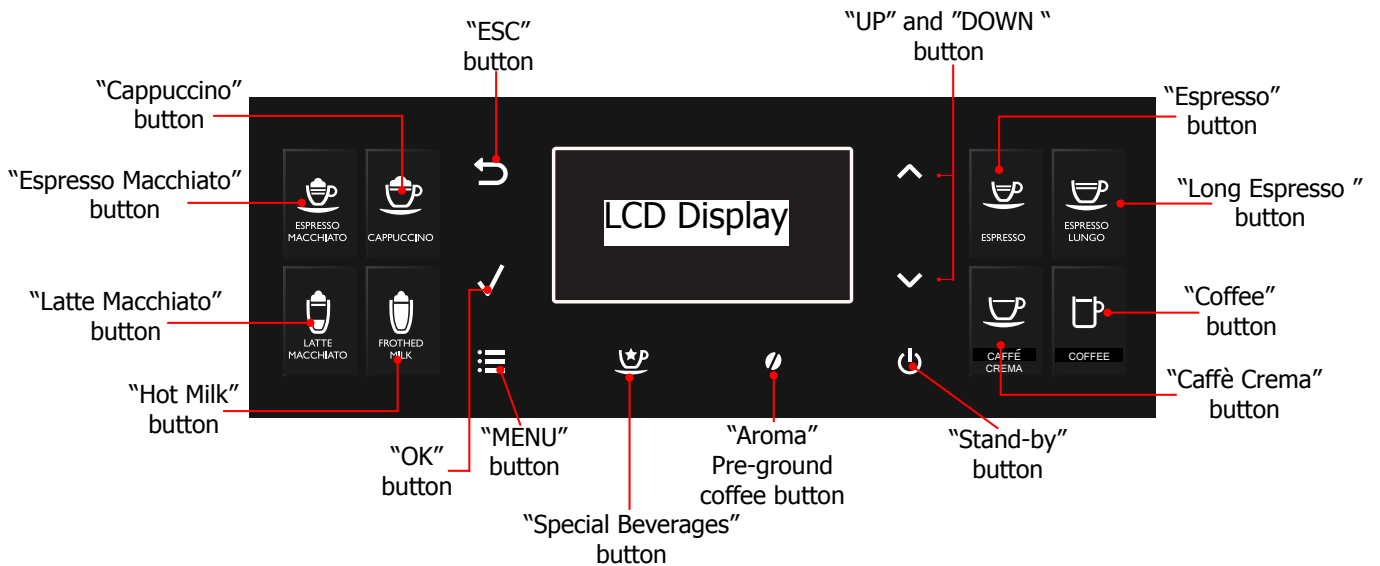
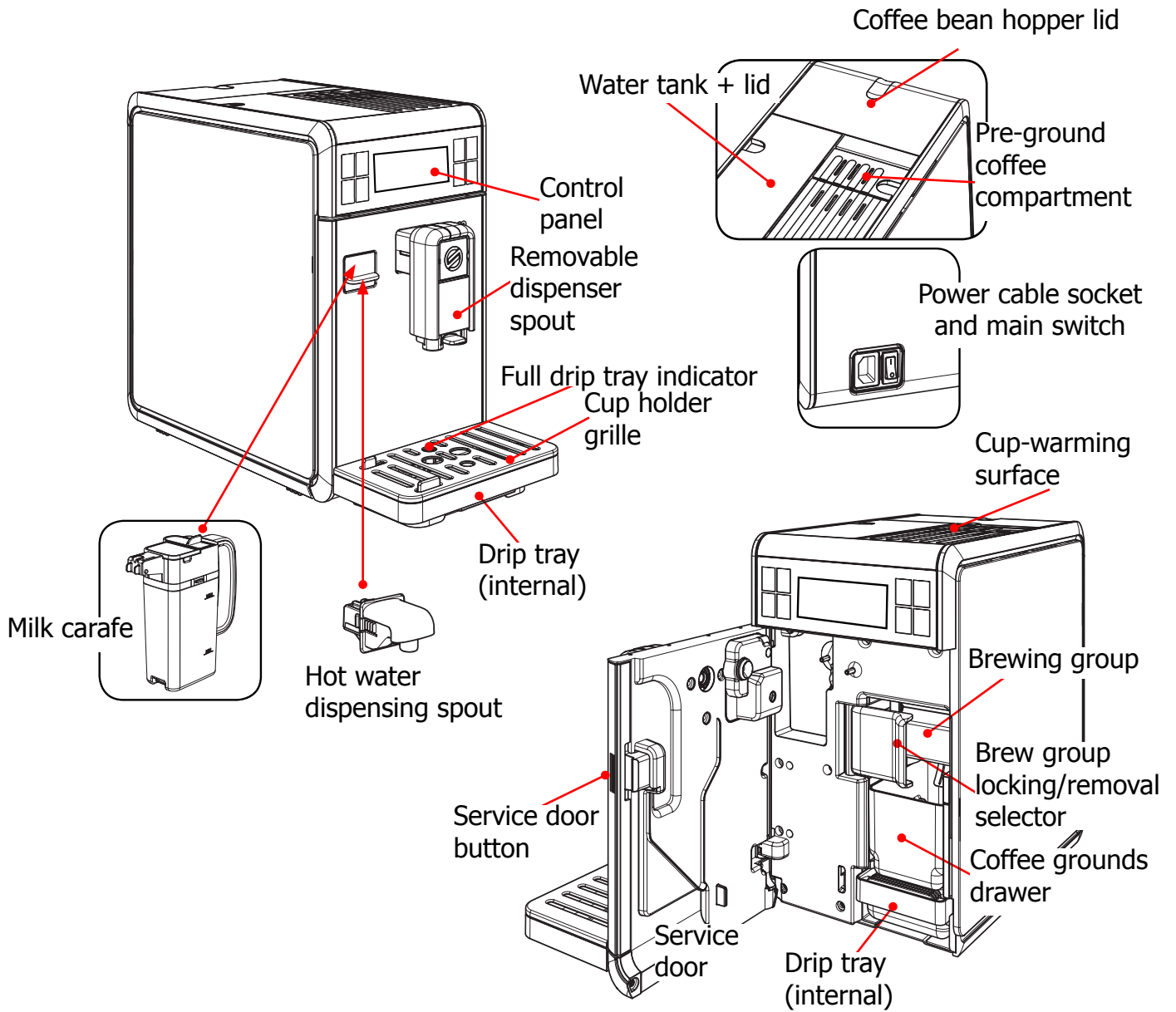

1.6.2. External machine parts GranBaristo

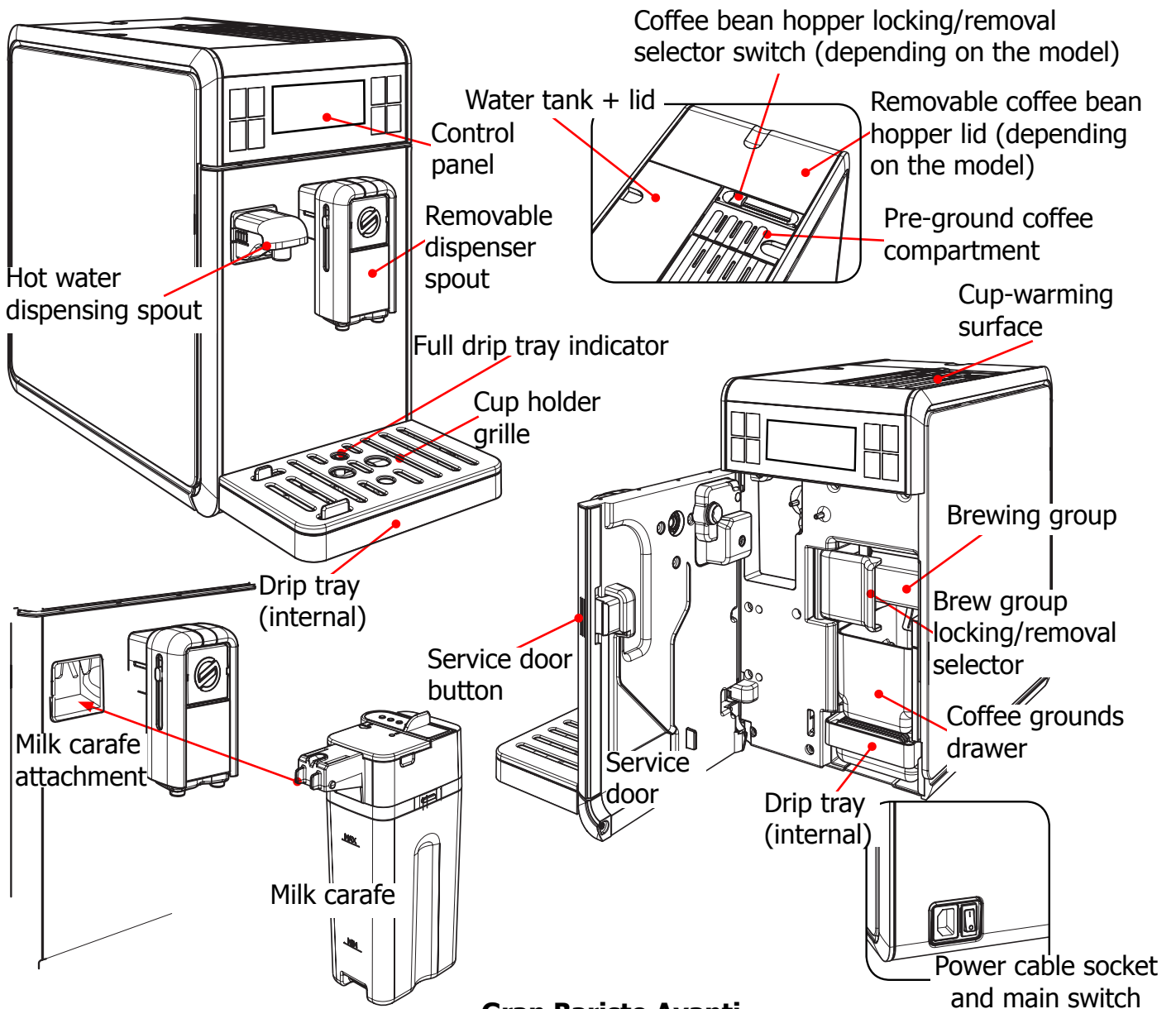

Gran Baristo Avanti

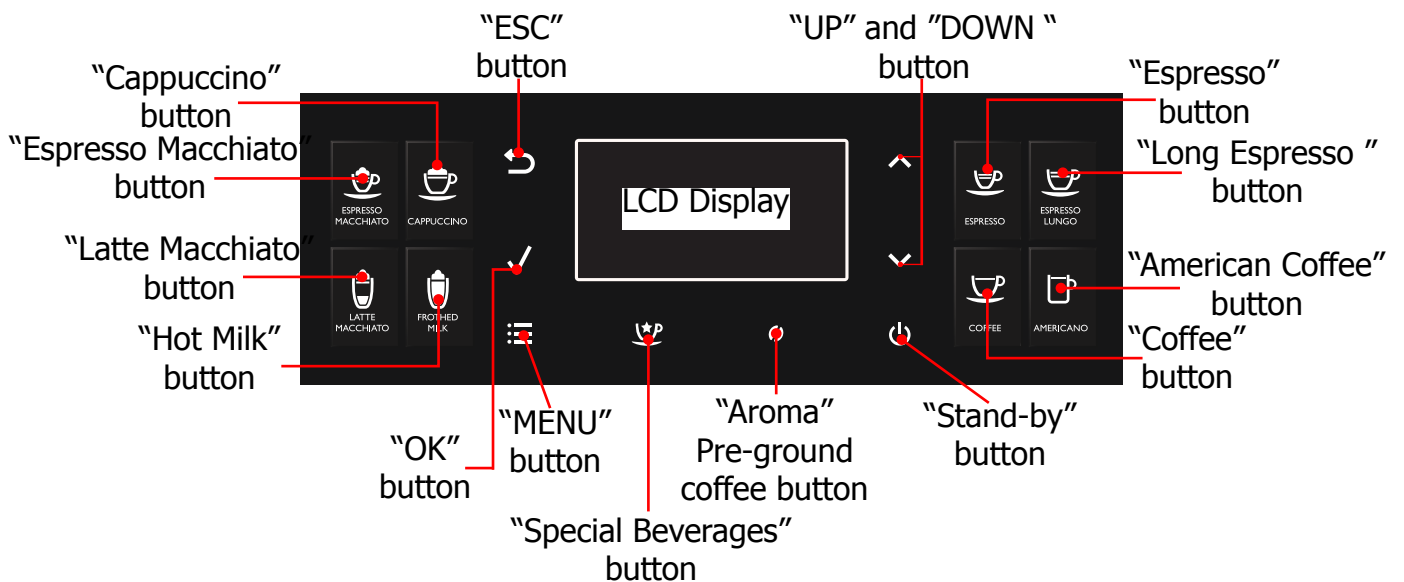

Gran Baristo

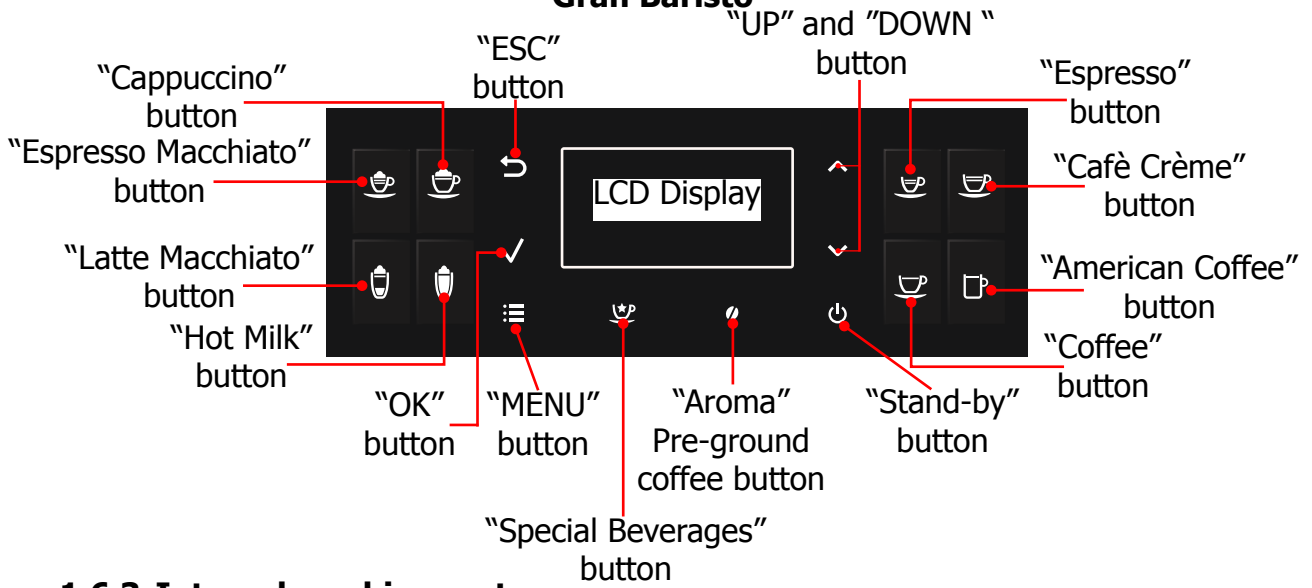

1.6.3. Internal machine parts

Grinding adjustment insert

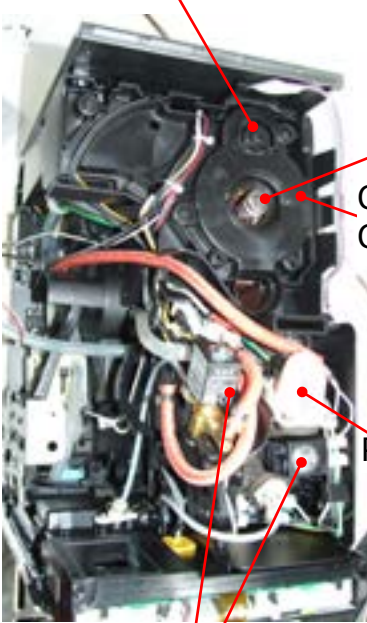

Coffee grinder

Cover and Coffee grinder

Piston assembly

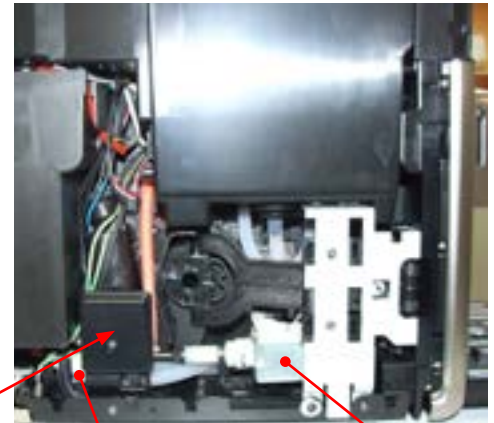

Flow-meter

Pump

Solenoid valve



Bluetooth board in Granbaristo Avanti



Power board



IRDA (To program the machine)

CHAPTER 2

TECHNICAL SPECIFICATIONS

2.1. Technical specifications

Power supply and output:	240 V~ 50 Hz 1900W - 230 V~ 50/60 Hz 1900 W 120 V~ 60 Hz 1300 W
Temperature monitoring:	(NTC) variable resistor sensor - transmits the value to the electronic card
Safety system:	2 thermostats at 190°C one shot
Coffee heat exchanger output: Stainless steel for coffee, hot water and steam dispensing	(230 V~) 1900 W - (120 V~) 1300 W - (100 V~) 1100 W
Gear motor:	2 rotation directions; power supply 24VC
Pump:	Ulka Type EP5/S GW approx. 13-15 bar with reciprocating piston and thermal switch 100°C 48 W, 230V, 50 Hz, 120V, 60Hz 100V, 50/60 Hz
Overpressure valve:	Opening at approx. 16-18 bar
Water filter:	In tank
Coffee grinder:	Direct current motor with flat ceramic grinder blades
Automatic dosage:	Dose adjustment controlled by the electronic system
Power consumption:	During heating phase- approx. 5.6 A
Dimensions: W x H x D in mm:	210 x 360 x 460 mm
Weight:	13 kg
Water tank capacity:	1.7 l
Coffee bean hopper capacity:	270 g. of coffee beans
Dreg drawer capacity:	20
Water circuit filling time:	Approx. 15 sec Max. on first filling cycle
Heating time:	Approx. 45 sec.
Grinding time:	Approx. 8-10 sec.
Only Gran Baristo Avanti	
Bluetooth:	Bluetooth Smart (low energy)
Maximum use distance:	5 m
Tablet compatibility:	Avanti App is compatible with iPad 3/4/Air/mini retina, running iOS7 and newer; with Samsung Galaxy Tab 3 (8.0")/Tab 4 (10.1")/Note pro LTE (12.2"), Nexus 7 2013 (7"), Sony Xperia Z LTE (10.1"), running Android v.4.3 and newer, and Bluetooth version 4.0 and newer.

2.2.1. Specification for the measurement of the coffee products temperature.

The temperature is influenced by the flow from the dispenser and stratification of temperatures in the glass. In order to consider these phenomena and to introduce measures that allow comparisons in controlled conditions, below guidelines must be followed:

Conditions:

- Water temperature in tank: 23°C (+/-2°C).
- It must be used a plastic cup (see picture N°1).
- It must be used a thermocouple thermometer (e.g. type K - see picture N°2).
- The coffee machine is tested without any change of parameters or calibrations, which may affect the temperature of products, so the measurement of temperature must be done with machine in default factory setting.

Procedure:

- The temperature must be measured in the cup, immediately after dispensing. Cup has to be placed on a non-metal surface using a thermocouple thermometer (Picture 1).
- The temperature in the cup is measured by immersing the probe of the thermometer up to touch the bottom. The probe then must be moved in a circular motion for 5/6 rotations. At the of the rotations, stop in the center of the cup (Picture 2).
- The highest temperature measured during the rotations is the value we are searching for, and that must be reported;
- Test measurement: from end of dispensing to the end of rotations must be completed within 12 seconds.
- the distance of the probe from the bottom of the glass is a function of the quantity of coffee dispensed: 10mm for 35gr - 17mm for 60gr - 35mm for 120gr and superior (Picture 3).

Limits of acceptability

The acceptance limits are divided by features and products and are the following:

Espresso Coffee Italy Q.ty 25/40 gr.

Temperature of 1st product 69°C ≤ 85°C

Temperature of 2nd product 72°C ≤ 85°C

Coffee Q.ty 70/120 gr.

Temperature of 1st product 69°C ≤ 85°C

Temperature of 2nd product 72°C ≤ 85°C

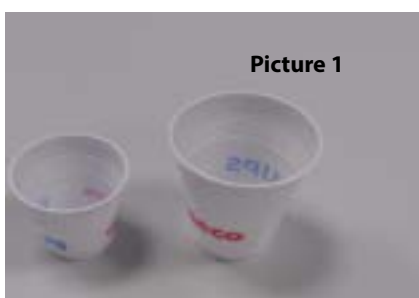

Picture 1



Picture 2

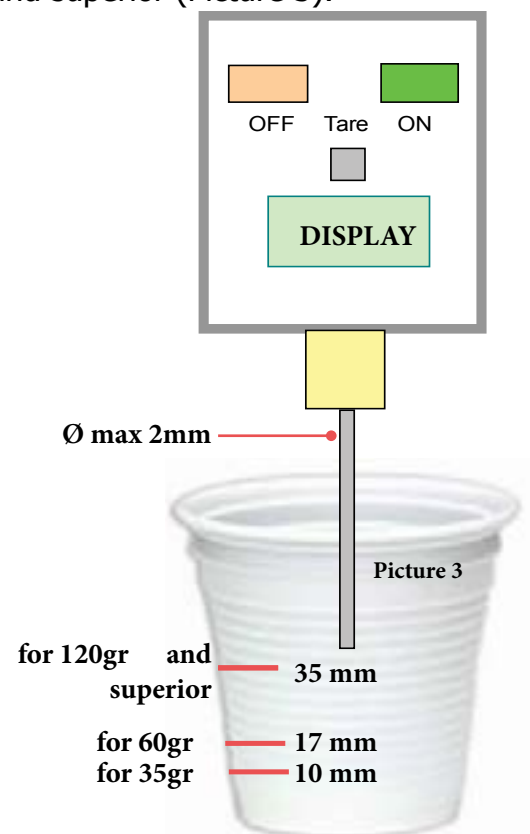

2.2.2. Specification for the measurement of the Milk products temperature.

Milk evaluation

To carry out the test, a partially skimmed UHT milk with a percentage of grease between 1.5-1.8% at a refrigerator temperature T_{refr} . (between 4 to 10°C) must be used.

The milk product must be checked on a beaker of 250 ml of capability and with an inner diameter of 70mm, brewing 100gr of product.

Parameters to be respected:

The parameters to be respected are: milk temperature and height of the cream. Each of these parameters, however, must be evaluated depending on the type of system used for the production of hot milk. Actually three types of devices are present on the appliances:

- Manual system (pannarello)
- Semi-Automatic system (cappuccinatore)
- Automatic system (carafe, Pinless wonder system, etc.)

Milk temperature in the beaker:

System with Pinless Wonder: With milk at T_{refr} . (about 4-10 °C): $\rightarrow \Delta \geq 45$

how does it work:

1. The milk is heated in the first chamber of the carafe thanks to the steam.
2. Then, it is mixed with air and frothed in the middle chamber.
3. Finally, in the outlet chamber, the 'typhoon effect' perfects the milk texture by removing the large bubbles

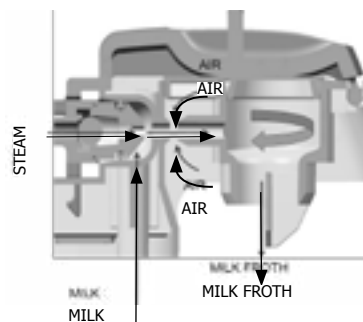

Height of the milk cream in the beaker:

Manual system (pannarello) ≥ 15 mm on 100gr. of brewed product

Semi-automatic system (cappuccinatore) ≥ 20 mm on 100gr. of brewed product

Automatic system: carafe, cappuccinatore, Pinless wonder e.g. (New Royal, Energica Pure, Intelia EVO latte) ≥ 20 mm on 100gr. of brewed product

How to measure the temperature of the milk.

1. The measurement is carried out in the beaker, immediately after the end of milk brew, positioned on a non-metallic surface, using a thermocouple thermometer (eg. Type K). Stop the preparation of mixed product: at the end of milk brewing, where "One Touch product" function is present.
2. The temperature is measured by immersing the probe of the thermometer, positioning the probe inside the beaker at about 10mm from the bottom of the container, then the probe moves in a circular motion for 3-5 turns, stopping at the end, at the center of the beaker. It detects the maximum temperature reached in a time of relief between 3 to 5 seconds. It is important the mixing of milk before the measurement at 10mm from the bottom of the beaker. If the mixing is correct, temperature, for a few fractions of a second, during the measurement should not oscillate.

How to measure the milk cream.

The temperature (Trefr or Tamb) of the milk doesn't affect as much the test result on measuring the milk cream; by convection is assumed to always use milk at refrigerator temperature Trefr..

Manual systems (Pannarello)

Pour 100cc. of milk at Trefr. in a beaker of 250 ml of capacity and with a inner diameter of 70 mm; with machine in steam mode:

1. Open the steam knob to discharger water circuit for 4 sec, then close the knob.
2. Place the beaker with the frother dipped in milk, open the steam knob to maximum and start the chronometer.
3. After about 30 to 60 seconds, close the knob and check the result on milk.

Semi-automatic systems (cappuccino)

Pours milk at Trefr. in a container ; with the machine in steam mode:

1. Open the steam knob to discharge water circuit for 4 sec. then close the knob.
2. Insert the silicone tube in the milk container, placing a beaker of 250 ml capacity and with an inner diameter of 70 mm under the cappuccino maker and open the steam knob.
3. After having provided 100gr. of product, close the knob and check the result obtained on milk.
Note: The same applies to machines which have a steam key on the user interface and a solenoid valve in place of the steam tap.

Automatic: Carafe, Cappuccino Pinless wonder e.g.:(New Royal, Energica Pure, Intelia EVO Latte), etc..

After setting the machine to delivery of 100gr. of product:

1. Launch the "hot milk" function.
2. Collect the product in a beaker with a 250ml of capacity and with an inner diameter of 70 mm, and verify the result obtained on milk. Carry out the test using milk at a Trefr..

In case the machine allows modify of the emulsion through the menu, use the machine with the emulsion set to the default value.

Related to the above testing procedure derives the following table of acceptability:

Manual, Semi-Automatic and Automatic's Milk System	
Grams of Product	Minimun Height of the milk cream
≥ 130	≥ 30mm
120	≥ 25mm
110	≥ 22mm
100	≥ 20mm
90	≥ 16mm
80	≥ 13mm
70	≥ 11mm

NB: To verify more accurately the height of the cream, a practical expedient dictated by experience is to add to the product just delivered a small amount of coffee. The addition of coffee immediately put in evidence the surface of separation between liquid and cream.

2.3. Machine parameters and performance GranBaristo V2

PRODUCT QUANTITY	Minimum Water quantity (ml)	Maximum Water quantity (ml)	Default Water quantity (ITA) (ml)	Tolerance	Milk Length (sec)	Aroma (Default)
Espresso	30	70	40	±10ml		Strong
Espresso Lungo	70	160	80	±10ml, for doses >100ml ±10%		Strong
Cafe Creme	70	180	125			Regular
Coffee	110	320	170	±10ml, for doses >100ml ±10%		Regular
Espresso Macchiato	30	70	40	±10ml	Default: 5 Range: 5-30	Strong
Cappuccino	30	170	54	±10ml, for doses >100ml ±10%	Default: 34 Range: 10-75	Strong
Latte Macchiato	30	170	32	±10ml, for doses >100ml ±10%	Default: 40 Range: 10-75	Strong
Milk Froth					Default: 34 Range: 10-75	
Hot Water	50	450	300	±10ml, for doses >100ml ±10%		
Ristretto	20	40	30	±10ml		Strong
Espresso Mild	30	70	40	±10ml		Mild
Espresso Intenso	40	110	70	±10ml, for doses >100ml ±10%		Extra Strog
Energy Coffee	110	320	190	±10ml, for doses >100ml ±10%		Extra Strog
Flat White	30	260	70	±10ml, for doses >100ml ±10%	Default: 20 Range: 10-50	Strong
Startup Rinsing			100	100		
Short Rinsing			40	40		
Power off Rinsing			100	100		
Water filter activation			1000	1000		
Brewing Unit cleaning			800	800		

Descaling frequency in AQUACLEAN GranBaristo V2 and GranBaristo Avanti V2

The first activation must make before you've paid up to 5000ml products because mind thinks as if he had the filter

Hardness	Filter number	Percentual on display 10% the icon flashes slowly. (encourage the consumer to buy the filter)	Percentual on display 0% the icon flashes quickly. (tell the consumer to change the filter)	MAX Quantity water, the icon turns off. (re- place filter)	
Indifferent	From 1/8 to 7/8	8050ml	2000ml	62500ml	Replace filter (you can not turn off)
	8/8				Descaling

If after descaling or after the use of a filter this is not reactivated , the machine recognizes the water hardness setting and calculates as in the table below

Descaling cycle frequency

Hardness	WATER HARDNESS	Without water filter	Not reactivating the filter
1	Soft (up to 7°dH)	240 litres (480,000 pulses)	210 litres (420,000 pulses)
2	Medium (7° - 14°dH)	120 litres (240,000 pulses)	105 litres (210,000 pulses)
3	Hard (15° - 21°dH)	60 litres (120,000 pulses)	52.5 litres (105,000 pulses)
4	Very hard (over 21°dH)	30 litres (60,000 pulses)	26.25 litres (52,500 pulses)

The default water hardness level is 4. Each litre of water corresponds to approximately 2,000 pulses.

2.4. Machine parameters and performance GranBaristo

PRODUCT QUANTITY	Minimum Water quantity (ml)	Maximum Water quantity (ml)	Default Water quantity (ITA) (ml)	Default Water quantity (ENG) (ml)	Milk Length (sec)	Aroma
AmericanCoffee	110	320	170	170		Regular
Espresso	30	70	40	50		Regular
Cafe Creme	40	110	70	70		Regular
Coffee	70	140	110	110		Regular
Ristretto	20	40	30	30		Regular
Espresso Mild	30	70	40	50		Mild
Espresso Intenso	40	110	70	70		Extra Strog
Energy Coffee	110	320	170	170		Extra Strog
Hot Water	50	450	300	300		
Latte Macchiato	30	170	70	110	Default: 25 Range: 10-75	Regular
Cappuccino	30	170	40	70	Default: 20 Range: 10-50	Regular
Espresso Macchiato	30	70	40	50	Default: 5 Range: 5-30	Regular
Cafe au lait	30	260	70	110	Default: 20 Range: 10-50	Regular
Frothed Milk					Default: 30 Range: 10-75	
Startup Rinsing			100	100		
Short Rinsing			40	40		
Power off Rinsing			100	100		
Water filter activation			1000	1000		
Brewing Unit cleaning			800	800		

Descaling frequency (Intenza) in GranBaristo and GranBaristo Avanti

Hardness	Water hardness	Without anti-scale filter	With anti-scale filter
1	Soft (up to 7°dH)	240 litres (480,000 pulses)	480 litres (960,000 pulses)
2	Medium (7° - 14°dH)	120 litres (240,000 pulses)	240 litres (480,000 pulses)
3	Hard (15° - 21°dH)	60 litres (120,000 pulses)	120 litres (240,000 pulses)
4	Very hard (over 21°dH)	30 litres (60,000 pulses)	60 litres (120,000 pulses)

The default water hardness level is 3. Each litre of water corresponds to approximately 2,000 pulses

2.5. How to Check for oil leakage in piston assembly.

In case of return because the machine indicates no coffee one of the causes could be the loss of oil from the piston assembly. To check this, proceed as follows:

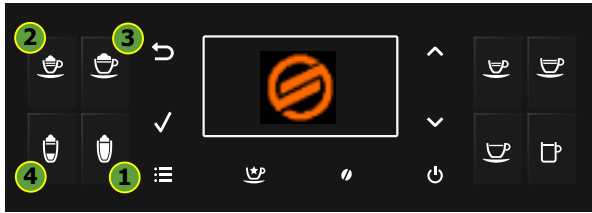

To enter Test Mode
When the display is turning ON, press the keyboard buttons in the order described below:

Press **UP** (^): go to next page

Brew Unit

This page allows to test the functionality of Brew Unit, BU Encoder, frontal door and dreg drawer:

BREW		UNIT	
Work	Home	mA: 0	
0	Ev Oil	Rst	4000
DDr	H/W	Door	Pres

The meaning of the sectors are the following:

Command:

Work: when pressed moves the brew unit to WORK

Home: when pressed moves the brew unit to HOME

Ev Oil: when pressed activates/deactivates the Oil electrovalve (24V Dc)

Rst: when pressed moves the brew unit in RESET(extraction) position(stop the brew unit if was in movement)



EV deactivate

The piston moves upward of approx. 5mm (OK)

ERROR: excursion >5mm approx. is (KO)



The piston moves up in case of lack of oil



EV activate

The piston moves upward until it stops.

WARNING: Deactivate the EV only when it goes back into its original position. Failing to do so could result in air being sucked into the circuit.



In case of oil leakage, remove the piston assembly clean any oil residue with a dry cloth and replace the piston assembly with a new one.

NOTE: Oil is of vegetal origin, certified for food contact, H3 (maximum in terms of food safety for oils).

CHAPTER 3

BRIEF INSTRUCTIONS

3.1.1. Customer menu in the Gran Baristo BaseV2 and AvantiV2

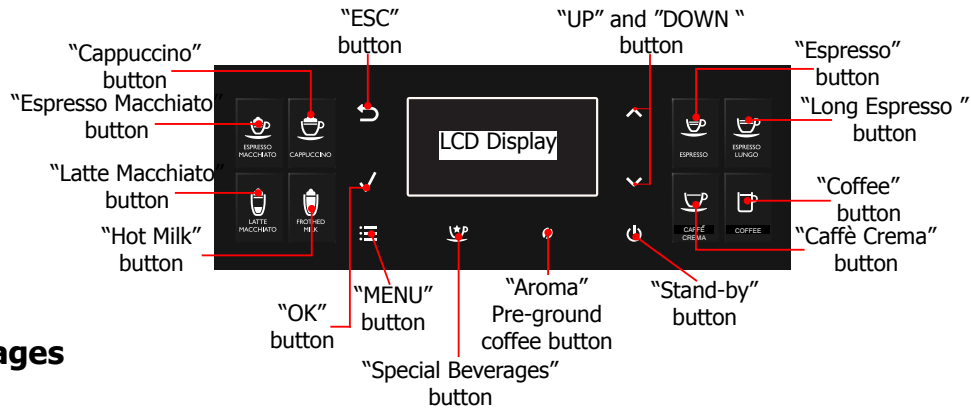

Display messages

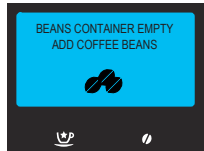

Fill the coffee bean hopper.

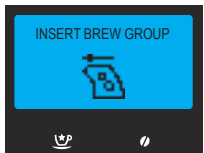

The brew group must be inserted into the machine.

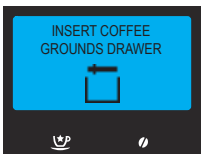

Insert the coffee grounds drawer and the internal drip tray.

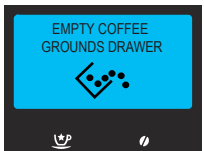

Empty the coffee grounds drawer.
Note: The coffee grounds drawer must be emptied only when the machine requires it and with the machine on. If the drawer is emptied with the machine turned off, the machine will not record the emptying operation.

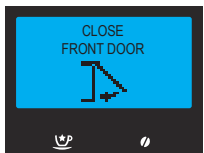

Close the service door.



Remove the water tank and fill it. You can fill the water tank also through the dedicated hole on the lid.

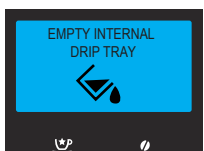

Open the service door and empty the internal drip tray.

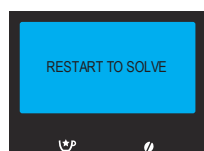

An event has occurred which requires the machine to be restarted. Take note of the code (E xx) shown at the bottom. Turn off the machine, wait for 30 seconds and turn it on again. If the problem persists, contact the Saeco hotline in your country and quote the code shown in the display.



Insert the coffee bean hopper lid and/or beans lid.

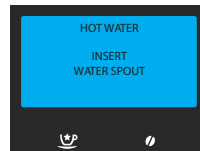

Insert the water dispensing spout to start dispensing. Press "ESC" to exit.

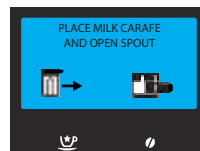

Insert the milk carafe with the dispenser open before starting the dispensing.



Machine descaling is needed. Refer to the maintenance menu to select and start the cycle.

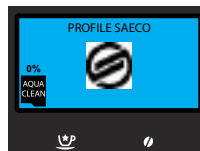

The machine signals the need to replace the water filter "AquaClean".

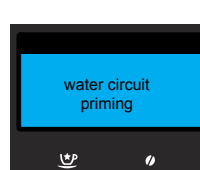

The machine is performing the loading of the hydraulic circuit. Wait for it to do so.

BLUETOOTH CONNECTION



Download the application on your mobile device to access the machine functions. To connect GranBaristo Avanti with your mobile device, download the Saeco Avanti App available on the App Store and Google Play or scan the QR code on the cover with your mobile device. As an alternative, connect to the www.saeco.com/Avanti-app website using the device on which you wish to download the application.

Note:

Before starting the connection procedure, make sure that the Bluetooth function on your mobile device is active.

The GranBaristo Avanti Bluetooth function is enabled by default. If it is disabled, follow the instructions below to enable it again:



Press the "☰" button to access the machine main menu.

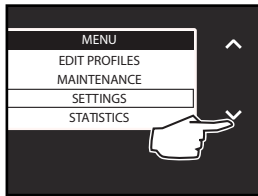

Press the "✓" button to select "SETTINGS". Press "✓" to confirm.

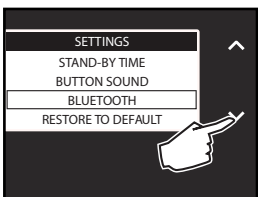

Press the "✓" button to select "BLUETOOTH".

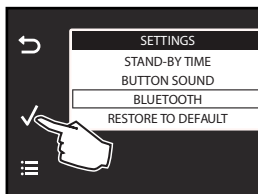

Press "✓" to confirm.

3.1.2. Customer menu in the Gran Baristo Avanti

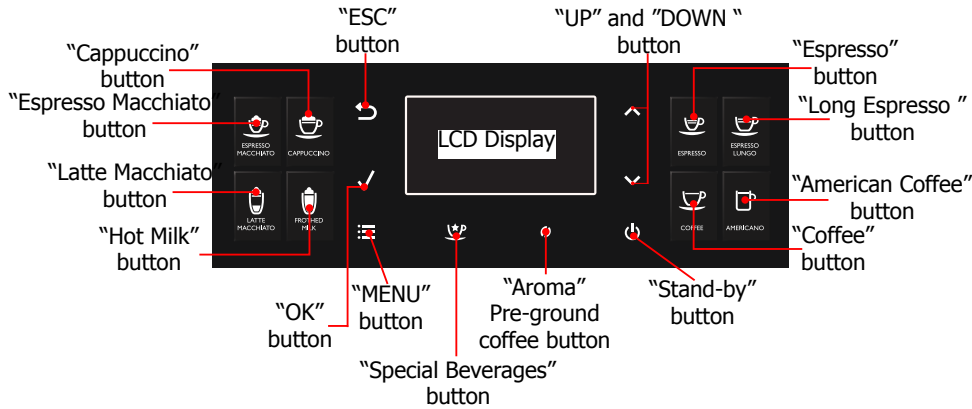

Display messages

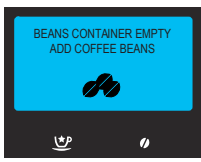

Fill the coffee bean hopper.

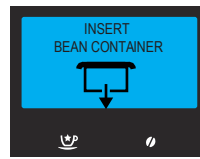

Insert the coffee bean hopper and/or beans lid. (no GranBaristo Base and Avanti V2)

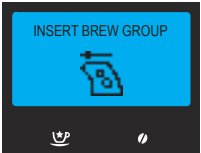

The brew group must be inserted into the machine.



Insert the coffee bean hopper lid and/or beans lid.



Insert the coffee grounds drawer and the internal drip tray.

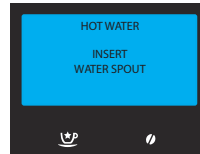

Insert the water dispensing spout to start dispensing. Press "ESC" to exit.

Empty the coffee grounds drawer.

Note: The coffee grounds drawer must be emptied only when the machine requires it and with the machine on. If the drawer is emptied with the machine turned off, the machine will not record the emptying operation.

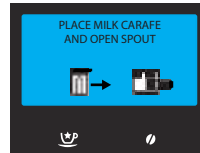
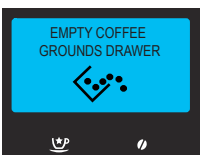

Before dispensing, insert the milk carafe with the dispensing spout open.

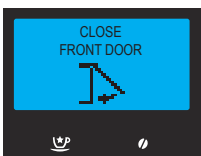

Close the service door.

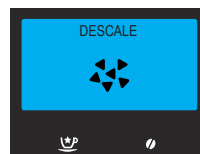

You need to descale the machine. Follow the steps described in the "Descaling" chapter of this manual.

Please note that not descaling your machine will ultimately make it stop working properly. In this case repair is NOT covered under your warranty.



Remove the water tank and fill it. You can fill the water tank also through the dedicated hole on the lid.

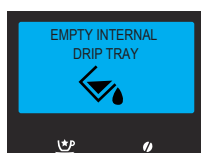

Open the service door and empty the internal drip tray.

Note: If this operation is performed when the machine is on, it will record the coffee grounds drawer emptying and will reset the counter; therefore, you need to empty the coffee grounds as well.

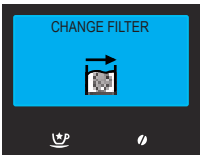

The machine needs the "INTENZA+" water filter to be replaced.



The red light flashes. Press any button to exit the stand-by mode.

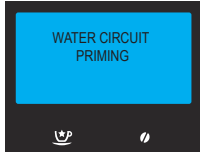

The machine is priming the water circuit. Wait for this operation to be over.

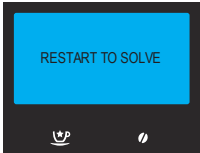

Take note of the code (E xx) shown on the display at the bottom. Turn off the machine. Turn it back on after 30 seconds. Repeat the procedure 2 or 3 times.

If the machine does not start, contact the Philips SAECO hotline in your country and quote the code shown on the display. Contact details can be found in the warranty booklet packed separately or at www.philips.com/support.

BLUETOOTH CONNECTION

Download the application on your mobile device to access the machine functions. To connect GranBaristo Avanti with your mobile device, download the Saeco Avanti App available on the App Store and Google Play or scan the QR code on the cover with your mobile device. As an alternative, connect to the www.saeco.com/Avanti-app website using the device on which you wish to download the application.



Note:

Before starting the connection procedure, make sure that the Bluetooth function on your mobile device is active.

The GranBaristo Avanti Bluetooth function is enabled by default. If it is disabled, follow the instructions below to enable it again:



Press the "☰" button to access the machine main menu.

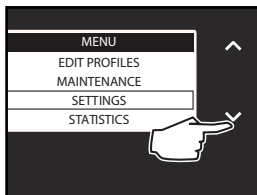

Press the "✓" button to select "SETTINGS". Press "✓" to confirm.

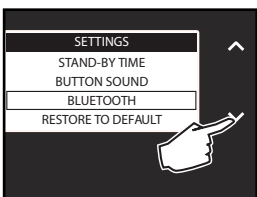

Press the "✓" button to select "BLUETOOTH".

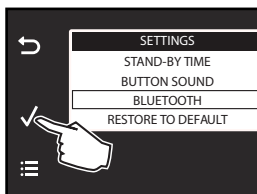

Press "✓" to confirm.

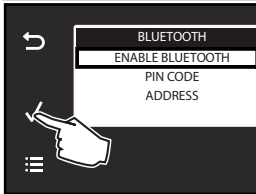

The "**BLUETOOTH**" management menu is displayed. Press "✓" to enable the function in the machine and to allow the connection of your mobile device.

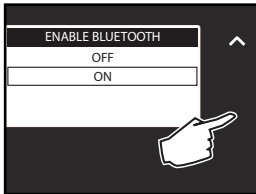

Press the "✓" button to select "**ON**".

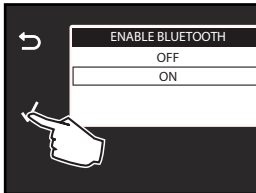

Press "✓" to confirm. The Bluetooth device is now active.

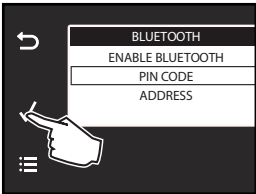

Press the "✓" button to select "**PIN CODE**". Press "✓" to confirm.

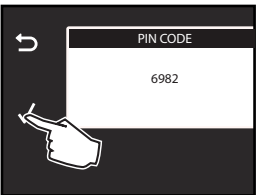

Write down the code, as it will be requested when connecting with your mobile device.

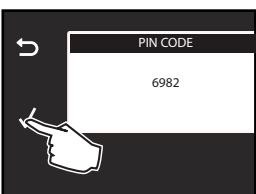

Press "✓" to confirm. Press the "☰" button to exit.

Note:

To exit the menu, press the "↶" button.

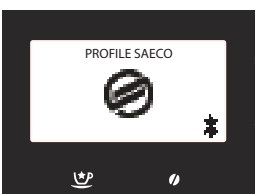

Enter the PIN code when you are prompted by the application and wait for a successful connection.

The ✕ icon shown on the display indicates that the connection was successfully established. Now you can interact with your coffee machine directly from your mobile device.

Warning:

Use the Saeco Avanti app to control your Gran Baristo only when you can see the machine in order to avoid injury or damage! You cannot use the pre-ground coffee function when operating the machine via the app.

Caution:

If you enter the wrong PIN code 5 times in a row, the machine disables the Bluetooth connection for safety reasons. Therefore, you will need to enable it again as previously explained.

Note:

Avanti App is compatible with iPad 3/4/Air/mini retina, running iOS7 and newer; with Samsung Galaxy Tab 3 (8.0")/Tab 4 (10.1")/Note pro LTE (12.2"), Nexus 7 2013 (7"), Sony Xperia Z LTE (10.1"), running Android v.4.3 and newer, and Bluetooth version 4.0 and newer.

3.1.3. Customer menu in the Gran Baristo.

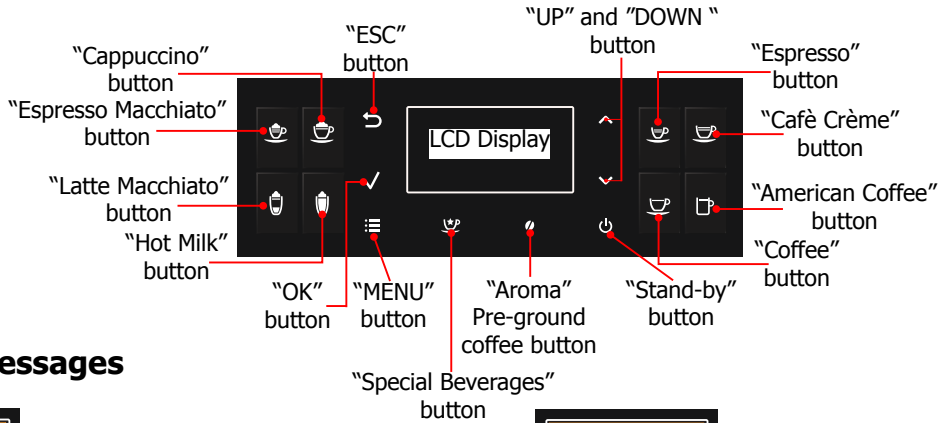

Display messages

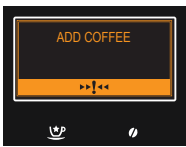

Fill the coffee bean hopper.

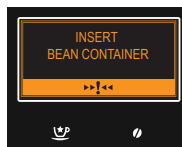

Insert the coffee bean hopper and/or beans lid.

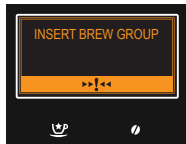

The brew group must be inserted into the machine.

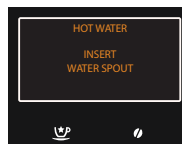

Insert the water dispensing spout to start dispensing. Press "ESC" to exit.

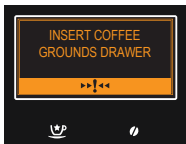

Insert the coffee grounds drawer and the internal drip tray.

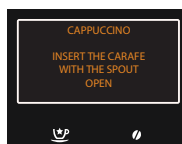

Before beginning to dispense, insert the milk carafe with the dispensing spout open.

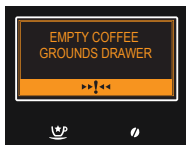

Empty the coffee grounds drawer.
Note: The coffee grounds drawer must be emptied only when the machine requires it and with the machine on. If the drawer is emptied with the machine turned off, the machine will not record the emptying operation.

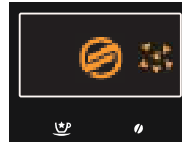

The machine needs to be descaled. Follow the steps described in the "Descaling" chapter of this manual. Please note that not descaling your machine will ultimately make it stop working properly. In this case repair is NOT covered under your warranty.

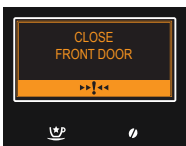

Close the service door.

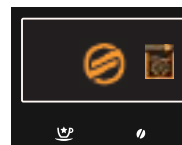

The machine needs the "INTENZA+" water filter to be replaced.



Remove the water tank and fill it. You can fill the water tank also through the dedicated hole on the lid.



The red light flashes. Press any button to exit the stand-by mode.



Take note of the code (E xx) shown on the display at the bottom and check out the table "Error codes" (par.05 TROUBLESHOOTING) the type of error that occurred.

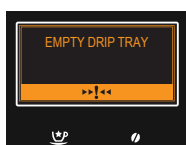

Open the service door and empty the internal drip tray.
Note: If this operation is performed when the machine is on, it will record the coffee grounds drawer emptying and will reset the counter; therefore, it is necessary to empty the coffee grounds as well.

CHAPTER 4

OPERATING LOGIC

4.1.1. Water circuit Granbaristo

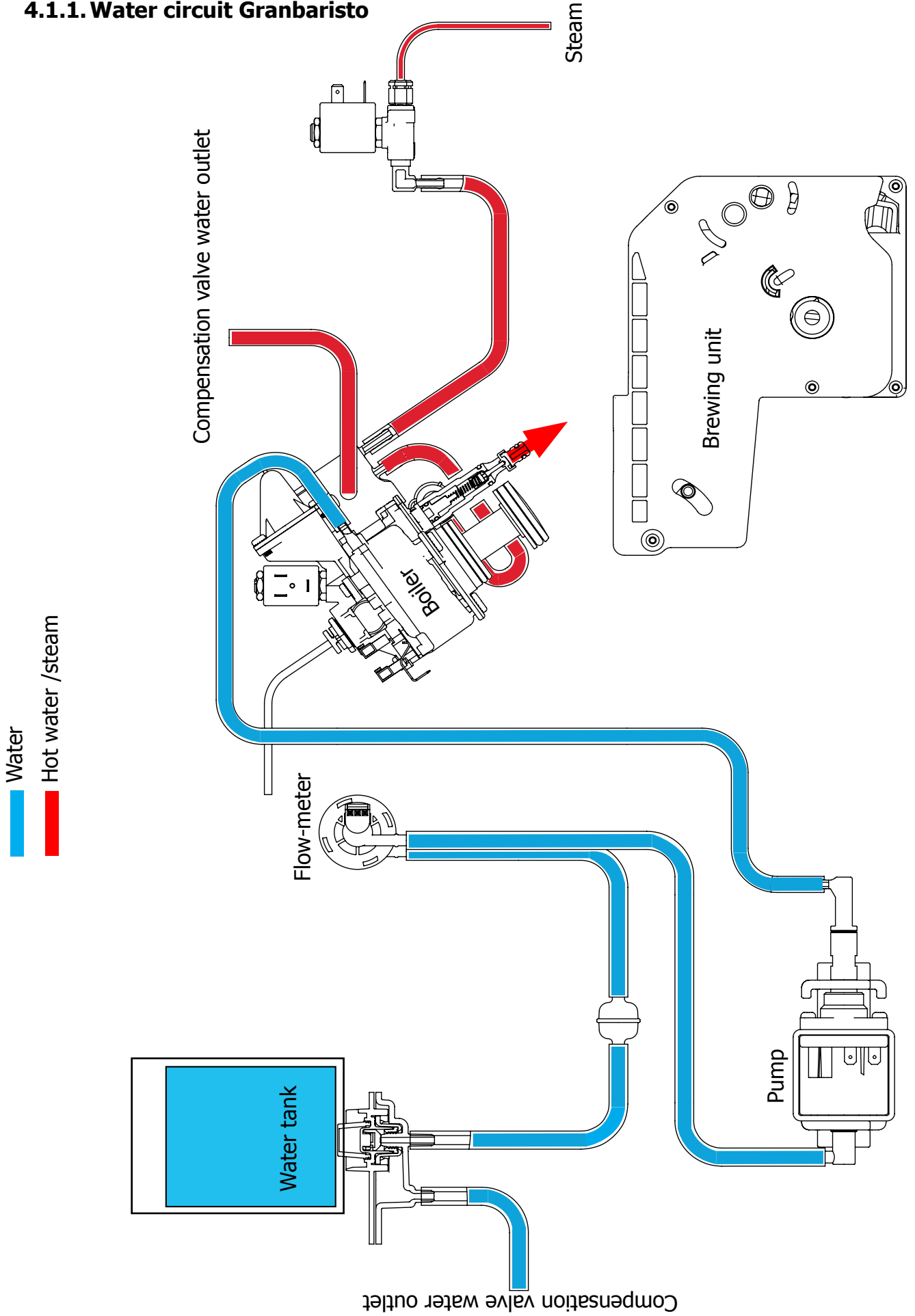

4.1.2. Milk Carafe

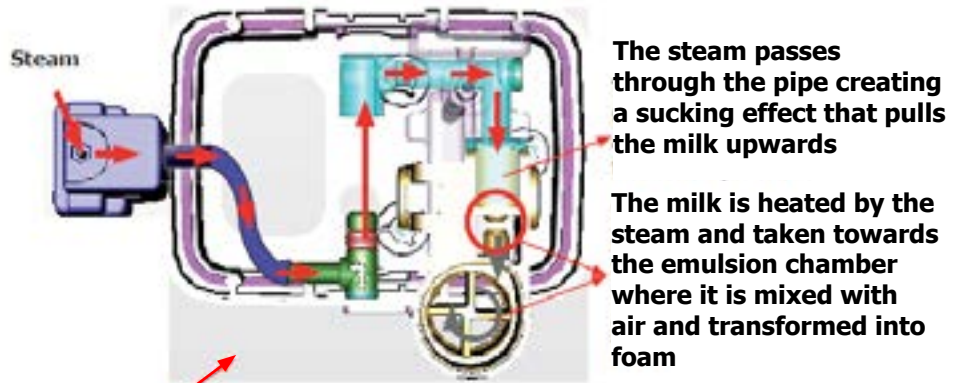

The steam passes through the pipe creating a sucking effect that pulls the milk upwards

The milk is heated by the steam and taken towards the emulsion chamber where it is mixed with air and transformed into foam

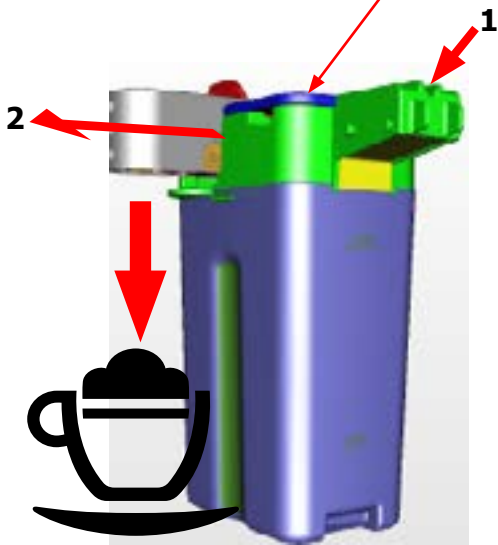

- 1) Steam input
- 2) Bring the cappuccino maker into dispensing position
- 3) Milk tank

Milk Carafe GranBaristo V2

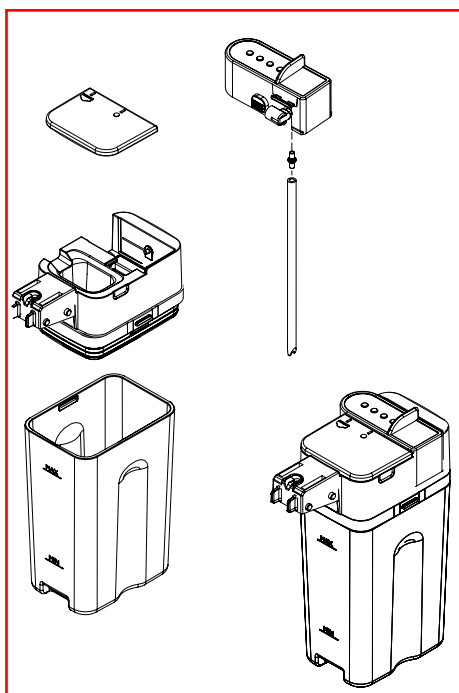
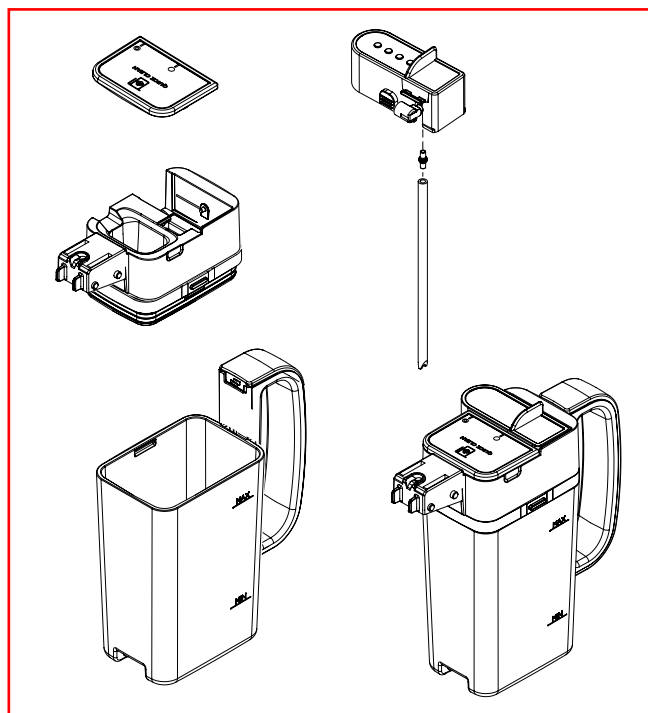

Milk Carafe GranBaristo

4.2. Coffee cycle

Main switch ON	START		STOP
Time			
Coffee grinder			Pulses (Dosage)
Heating	approx. 45 sec.		
Pump			Pump operation (flow meter pulses) in accordance with the amount of product selected.
Brewing unit gear motor			*
Status	Heating	Ready	Coffee cycle

Notes: * Only with Pre-brewing



Single microswitch gear motor

Switching on

When the machine is switched on, the gear motor repositions itself as follows:

- It acts on microswitch 1 (see following chapter).
- The gear motor changes its rotation direction and moves upwards again by approx. 1-2 mm.
- The boiler begins to heat the water for approx. 30 sec with controlled power, in order to reach the optimal temperature. The temperature will then remain at a constant level.

Coffee cycle

1. The grinding process is controlled by time duration in function of coffee strength selected.
2. The gear motor (brewing unit) moves to the brewing position.
3. Preliminary dispensing phase (short pump activity, short pause).
4. Product dispensing (the pump operation period is defined by the amount of product dispensed).
5. The gear motor moves to its home position (the dregs are expelled automatically).

4.3. Single microswitch

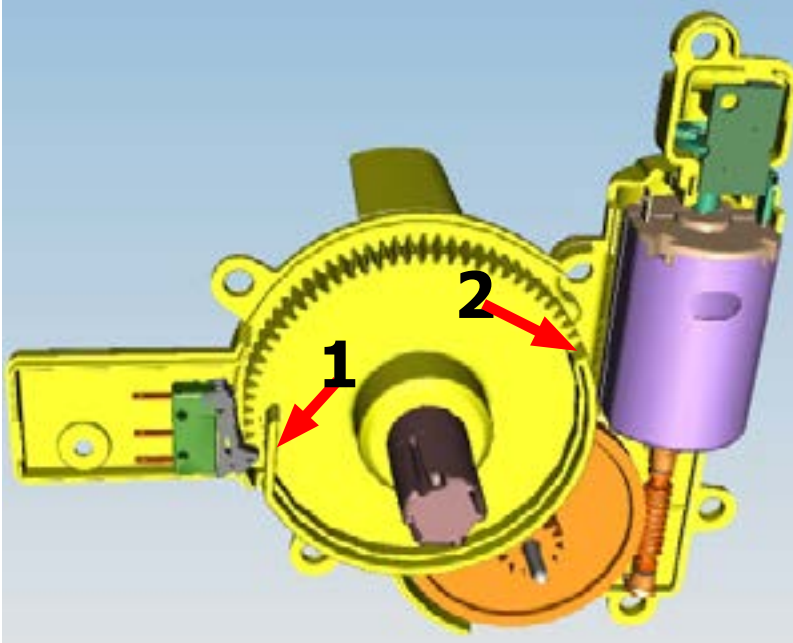

The gear motor is powered by a direct current motor that engages with the smaller double toothed wheel using a worm screw. The unit is mounted on the axle of the large gear wheel and when a coffee is requested, it moves from the standby position to the dispensing position, and then back to the standby position again.

- **Standby position: 1**
- **Dispensing position: 2**

4.4. Temperature sensor (adjustment)

Temp. (°C)	R nom (kΩ)	ΔR (+/- %)
20	61.465	8.6
50	17.599	5.9
75	7.214	4.1
80	6.121	3.7
85	5.213	3.4
90	4.459	3.1
100	3.3	2.5
125	1.653	3.9
150	0.893	5.1

An NTC is used as a temperature sensor; in the event of overheating this reduces boiler element power consumption.

The electronic system detects the current boiler temperature from the drop in voltage of the sensor and adjusts it accordingly.

Heating element values and corresponding temperatures: see table.

4.5. Coffee grinder

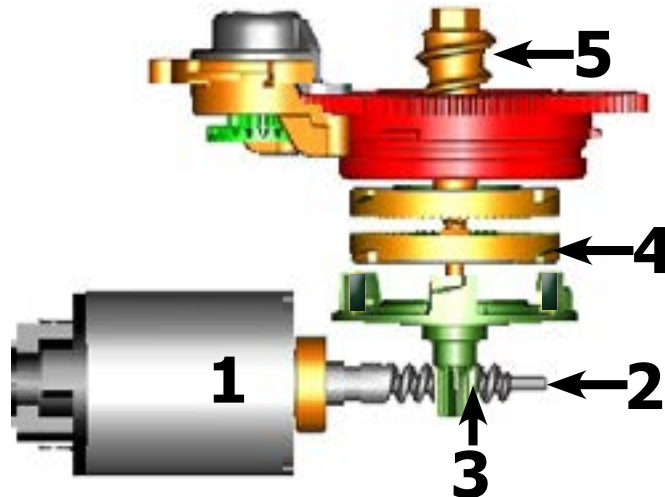

The coffee grinder is driven by a direct current motor (1) using a worm screw helicoidal wheel transmission (2).

The worm screw (2) drives a plastic gear wheel (3), which turns the lower grinder (4) and the increment pin (5)

4.6. Water level detection (water tank)

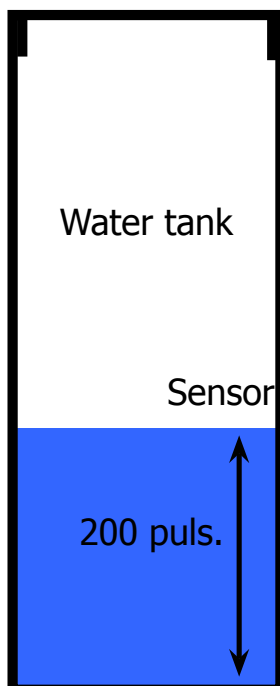

“Water low” message (water reserve)

Function:

The water level is monitored by a capacitive sensor, located one third of the way up the water tank wall.

If the electronics assembly detects, by means of the sensor, that the amount of water in the tank has dropped below the above mentioned level, a water reserve remains available for the dispensing process underway (this will cover 200 flow meter pulses).

The product dispensing process will then come to an end.

If a dispensing cycle ends after the sensor has been triggered (in the reserve) then the display “Water low” continues to be displayed during the following dispensing cycle.

4.7. Descaling request

“Descaling” – message with water filter inserted
(appliances with display only)

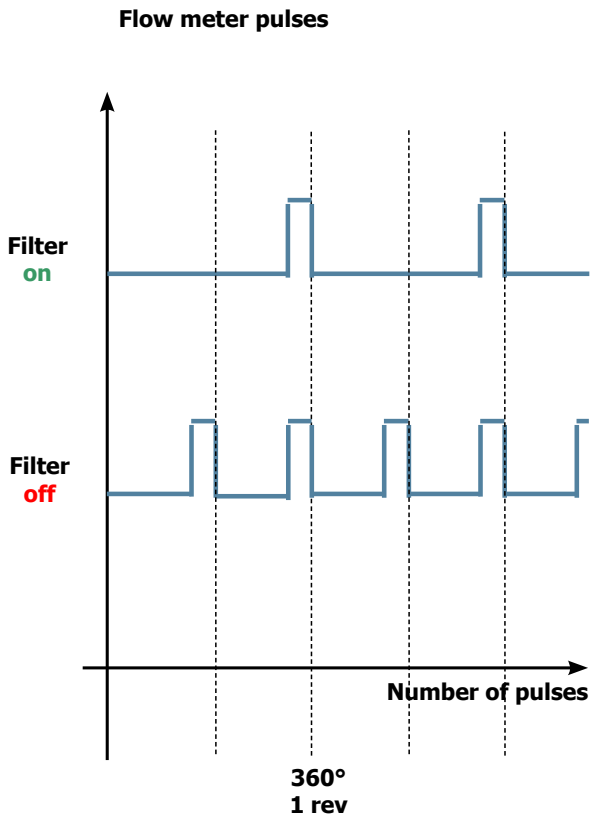

The water hardness is set on the basis of the regional water hardness analysis (1, 2, 3, 4).

Filter off:

If the function is turned off the electronics assembly monitors the flow meter pulses, recording one pulse each turn.

Filter on:

If the function is turned on the electronics assembly monitors the flow meter pulses, recording one pulse every two turns.

“Change water filter” message

The electronics assembly uses the flow meter impulses to keep track of the amount of water which has flowed through; after the specified amount (set in accordance with the water hardness level), the “Replace filter” message appears.

4.8. Water filter GranBaristo and GranBaristo Avanti

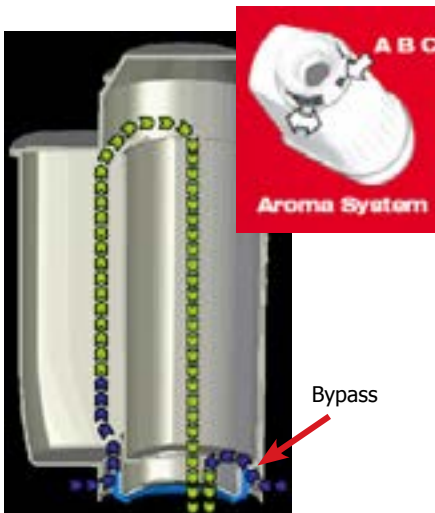

Function:

- Reduced limescale deposits which take longer to form.
- Improved water quality.
- Improved taste due to the ideal water hardness.

Life span / descaling performance:

- - 10 ° dH
- 60 litres
- 2 months

To achieve the best possible operating mode consistency over the total life span, the water is channelled using a 3-stage bypass (A, B, C) depending on the degree of hardness. See small image.

Descaling frequency (Intenza) in GranBaristo and GranBaristo Avanti

Hardness	Water hardness	Without anti-scale filter	With anti-scale filter
1	Soft (up to 7°dH)	240 litres (480,000 pulses)	480 litres (960,000 pulses)
2	Medium (7° - 14°dH)	120 litres (240,000 pulses)	240 litres (480,000 pulses)
3	Hard (15° - 21°dH)	60 litres (120,000 pulses)	120 litres (240,000 pulses)
4	Very hard (over 21°dH)	30 litres (60,000 pulses)	60 litres (120,000 pulses)

The default water hardness level is 3. Each litre of water corresponds to approximately 2,000 pulses

4.9. AquaClean water filter GranBaristo V2 and GranBaristo Avanti V2 (Cod. 421944050461 ACC SAE WATER FILTER LGV 1UNIT EU)

The SAECO AquaClean water filter purifies the water your machines uses for brewing coffee. This results in a greater coffee taste. Moreover it prevents mineral deposits in the water to build up, which eliminates the need of descaling your machine for 500000ml of water. We recommend installing the water filter AquaClean the first use of the machine to the maximum before using 5000 ml of water.

After a period of uses the machine, the display will indicate when the filter needs to be replaced, the maximum limit equivalent to 62500ml.

In this way you can replace the filter 8 times without the need for descaling. This equals approx. 500000ml of water. When Aquaclean filter is activated the display will show an icon indicating the percentage of use (initially 100%).

The conditions related to the filter work environment, water, therefore, an active environment for bacteria and microorganisms, require the replacement with a minimum frequency. The filter, indeed, is activated and starts working from the time is filled with water and continues working even with the machine off.

3 months from the activation is the correct replacement frequency to ensure the best performance and the proper operation.

The filter can not be deactivated manually, as it must end its life cycle.

The filter symbol flashes slowly when the autonomy of the current filter becomes less 8050ml (percentage shown on the display 10%). When the autonomy of the current filter becomes less than 2000ml (percentage shown on display 0%) the icon flashes quickly. After a maximum of 62500ml of water supplied the flashing light turn off. Because you did not activate a new filter, the machine will show that after a while' you need to start descaling.

After the flashing light goes out is calculated:

(for example) After using 1 filter, the TH reduces of 1/8. With Water hardness 4 and brewing just coffee/water products the TH is set to 30 liters. 30 liter minus 1/8 is 26,25 liters. The first filter expires at 62,5liters - > the warning "DESCALE" should appear at 26,25+62,5 = 88,75 liters from start.

If the consumer is using the AquaClean filter, and replaces it when indicated by the machine. The machine needs to be descaled after 8 filter replacements. When the 8th filter needs to be replaced the machine will inform you need to descale before placing a new filter.

Note: the quantities of water, for each cycle of the filters, are not affected by the hardness of the water itself. The machines : Intelia Evo2 , Granbaristo V2 , Exprelia V2 , New Incanto e Cattiva will mount a water container can only mount the filter Aquaclean and will not be able to mount the old.

Descaling frequency in AQUACLEAN					
The first activation must make before you've paid up to 5000ml products because mind thinks as if he had the filter					
Hardness	Filter number	Percentual on display 10% the icon flashes slowly. (encourage the consumer to buy the filter)	Percentual on display 0% the icon flashes quickly. (tell the consumer to change the filter)	MAX Quantity water, the icon turns off. (replace filter)	
Indifferent	From 1/8 to 7/8	8050ml	2000ml	62500ml	Replace filter (you can not turn off)
	8/8				Descaling

If after descaling or after the use of a filter this is not reactivated , the machine recognizes the water hardness setting and calculates as in the table below

Descaling cycle frequency			
Hardness	WATER HARDNESS	Without water filter	Not reactivating the filter
1	Soft (up to 7°dH)	240 litres (480,000 pulses)	210 litres (420,000 pulses)
2	Medium (7° - 14°dH)	120 litres (240,000 pulses)	105 litres (210,000 pulses)
3	Hard (15° - 21°dH)	60 litres (120,000 pulses)	52.5 litres (105,000 pulses)
4	Very hard (over 21°dH)	30 litres (60,000 pulses)	26.25 litres (52,500 pulses)

The default water hardness level is 4. Each litre of water corresponds to approximately 2,000 pulses.

CHAPTER 5

SERVICE MODE

5.1.1. Test Mode Gran BaristoV2 and AvantiV2

To enter Test Mode

When the display turns ON, press the keyboard buttons in the order described below:



Description

When the machine is in Factory Test Mode appears a windows divided in several sectors:

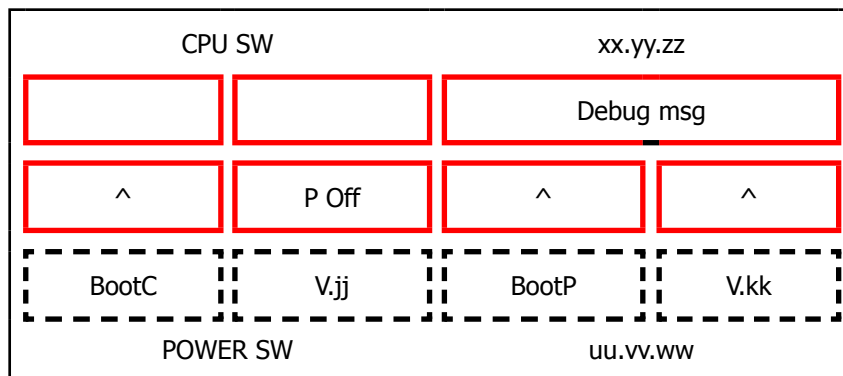

The first row of each window is a title, the red sectors represents the functions (or loads) available to activate or deactivate, the last row is used to show other info. When a function is enabled the corresponding box becomes colored. The dotted sectors is used to show informations about the status of microswitch, sensors or other variables.

The presence of symbol (^) into a sector indicate that no function is associated to.

The following image show the corispondence between the keyboard and red sectors:

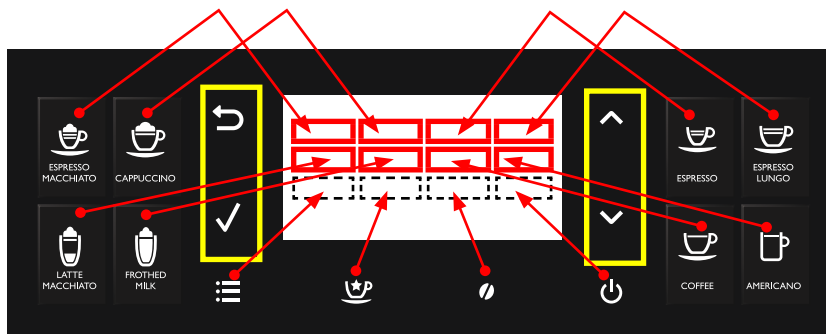

The keyboard buttons (ESC, OK, UP and DOWN), highlighted in yellow, have the following functions:

- UP** : go to next page
- DOWN** : go to previous page
- OK (✓)**: confirm / enable / disable function
- ESC (↵)** : exit from Factory Test Mode

Activation of loads

In Test Mode all loads are initially disabled.

To activate a load press the corresponding button on keyboard, to deactivate press again the same button.

Other conditions for which a load may be switched off automatically without key presses are:

- If it is defined a working cycle, when this cycle ends (such as the grinder or brew unit)
- The achievement of 90°C for boiler

Navigation in Test Mode

SoftwareVersion

This is the first window of Factory Test Mode. It show the version of CPU software and CPU bootloader version, the PWR software and PWR bootloader version and is possible to activate or deactivate the POff feature and Debug info.

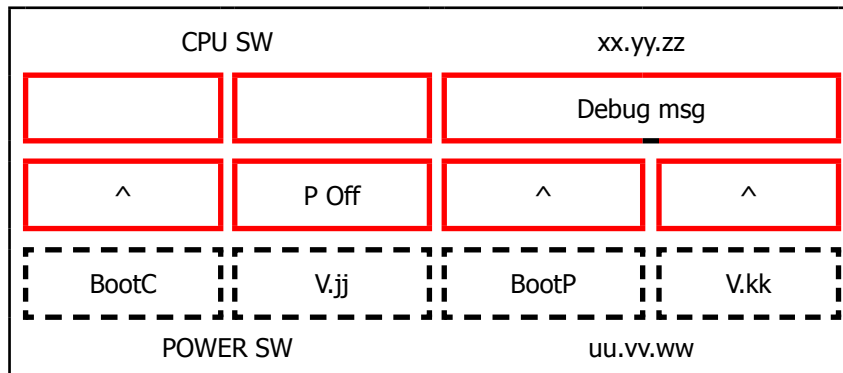

Press **OK (✓)** button to modify one of the following feature:

Debug msg: if enabled (colored box), only for next startup, allows the visualization of the following debug info on display in Ready state:

Grinder Time Aroma 1 (msec)	Encoder Pulses Home Work About Last Cycle	Encoder Dreg Counter: 4000 ->dreg drawer empty 0-> dreg drawer full	Grinder Time Aroma 4 (msec)
Grinder Time Aroma 2 (msec)			Grinder Time Aroma 5 (msec)
Grinder Time Aroma 3 (msec)			Grinder Time Aroma 6 (msec)
	Encoder Pulses from HOME to Pod Pressure about Last Cycle	Target Encoder Pulses from HOME to Pod Pressure about last Cycle	

P Off: if enabled (colored box), allows the machine to enter in standby mode immediately after powering ON from the main switch.

Make sure that the function **P Off** is turned ON and the **Debug msg** is turned OFF.

Press **UP (∧)**: go to next page

Keyboard

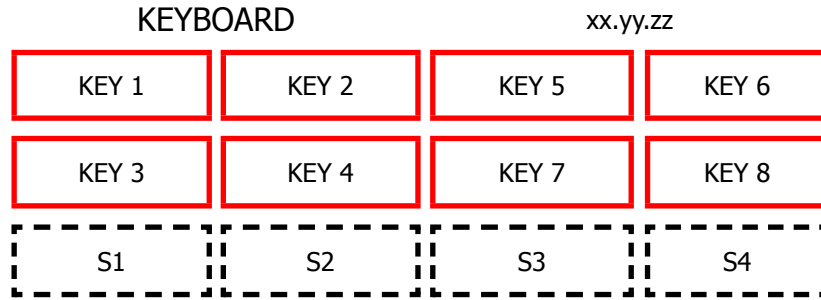

This page allow to test each button of keyboard (is shown its version) with the following correspondence:

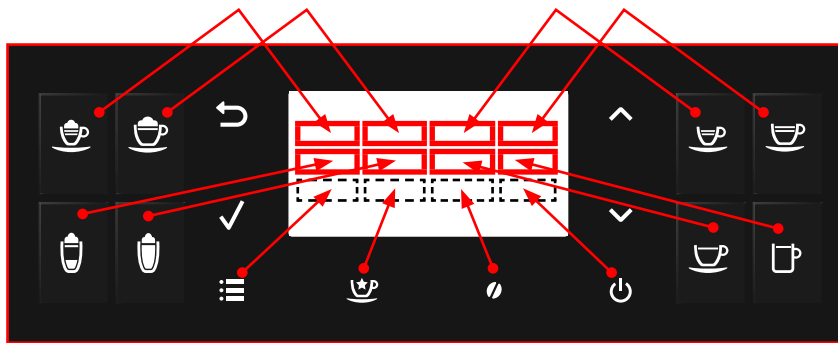

When is pressed a button the corresponding box becomes with background colored and the led of keyboard is turned ON, if it is pressed again becomes with black background and the led of keyboard is turned OFF(except for UP, DOWN and ESC that are always turned ON).

Press **UP** (^): go to next page

Brew Unit

This page allow to test the functionality of Brew Unit, BU Encoder, frontal door and dreg drawer:

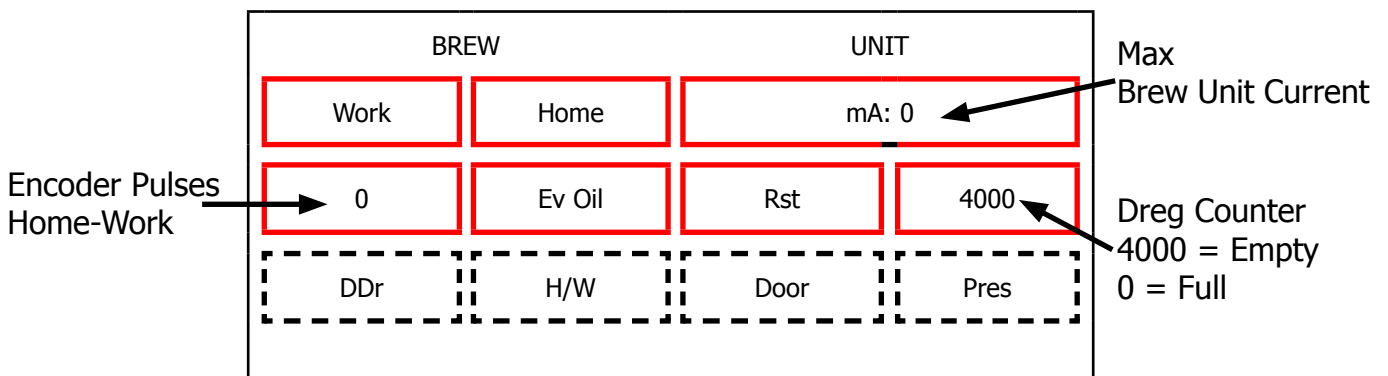

The meaning of the sectors are the following:

Command:

Work: when pressed move the brew unit to WORK

Home: when pressed move the brew unit to HOME

Ev Oil: when pressed activate/deactivate the Oil electrovalve (24V Dc)

Rst: when pressed move the brew unit in RESET(extraction) position(stop the brew unit if was in movement)

Info:

mA: indicates the maximum current (in mA) absorbed by the brew unit in motion. The value must not exceed the following values:

- 600 mA with new the brew unit
- 450 mA with a brew unit with at least 5 product executed
- 130 mA without brew unit

Encoder Pulses Home-Work: indicate the number of encoder pulses from Home to Work position or vice versa. Move the brew unit from Home to work or vice versa and the measured value must be in the range [2000 – 2100].

H/W: Becomes active when the Brew Unit reach HOME or WORK position

Pres: Becomes active if the Brew Unit is present in machine

DDr: Becomes active if the Dreg Drawer is present in machine

Door: Becomes active if the Frontal Door is closed

Press **UP (^)**: go to next page

Hydraulic Circuit

This page allow to test the functionality of hydraulic circuit:

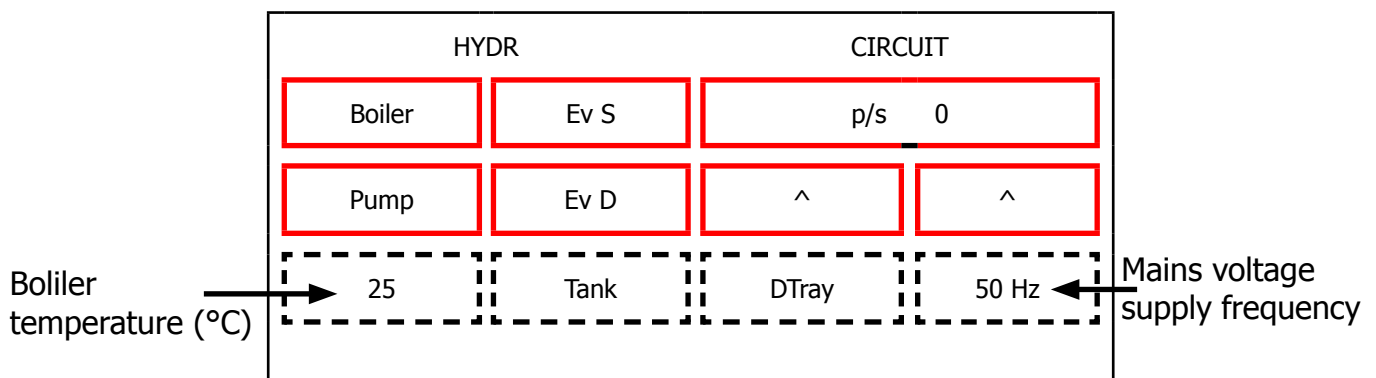

The meaning of the sectors are the following:

Command:

Boiler: when pressed activate/deactivate the boiler if the temperature is less than 90°C

Pump: when pressed activate/deactivate the pump

Ev S: when pressed activate/deactivate the Steam/Water electrovalve (24V Dc)

Ev D: when pressed activate/deactivate the discharge electrovalve (24V Dc)

Info:

p/s: indicate the current number of water flow expressed in pulses/sec. When is activated the pump and one electrovalve the value measured must be equal to or greater than 10 p/s.

Tank: Becomes active when the water into tank reach sensor level

DripTray: Becomes active when the water into drip tray reach sensor level

Frequency: indicate the frequency of mains voltage supply

Boiler Temperature: indicate the boiler temperature in °C

Press **UP (^)**: go to next page

Grinder

This page allow to test the functionality of grinder:

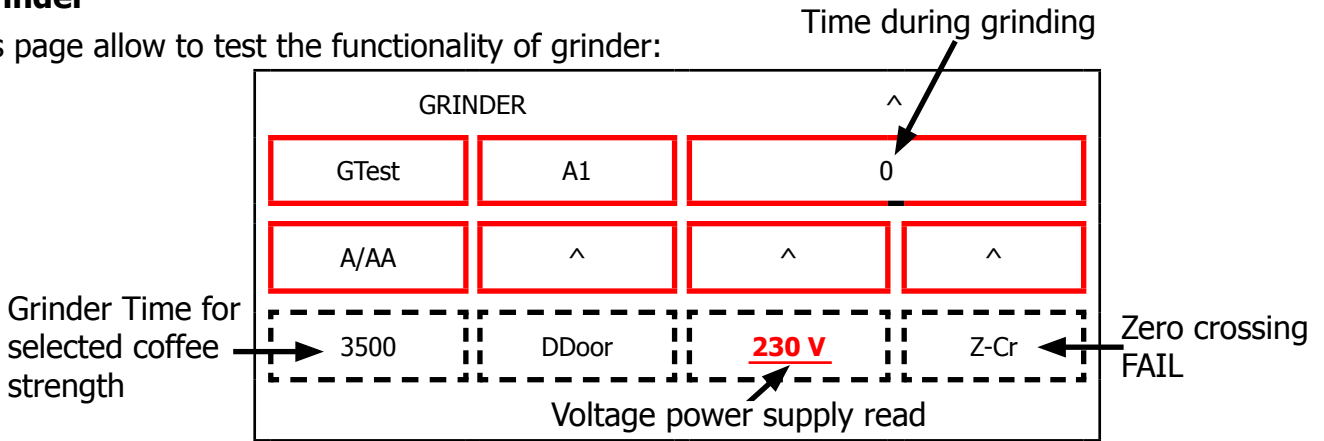

The meaning of the sectors are the following:

Command:

A1: Selected Coffee Strength. If pressed change the current coffee strength from A1 to A6

- **A1:** Very Mild
- **A2:** Mild
- **A3:** Regular
- **A4:** Strong
- **A5:** Very Strong
- **A6:** Extra Strong
- **A/AA:** A = use the current coffee strength ; AA = add 33% of time to the current coffee strength
- **GTest:** Activate/Deactivate the grinder for a time corresponding to the selected coffee strength.

Info:

Time during grinding: indicate the time while the machine is grinding in msec

DDOOR: indicate the status of hopper door (colored box -> closed)

Z-cr: Colored box indicate that the measure of zero crossing is FAIL.

230V: indicate the voltage power supply detected from PWR board. Can assume only this two values: 230V or 120V

Press **UP (^)**: go to next page

Display

This page allow to change display settings (brightness and contrast):

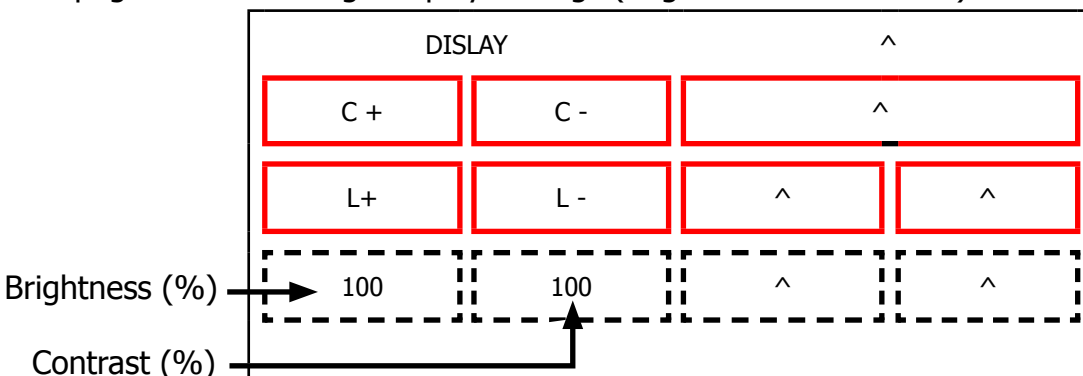

The meaning of the sectors are the following:

Command:

- C+:** increase the display contrast
- C- :** decrease the display contrast
- L+:** increase the display brightness
- L- :** decrease the display brightness

Bluetooth

This page allow to check the BT module

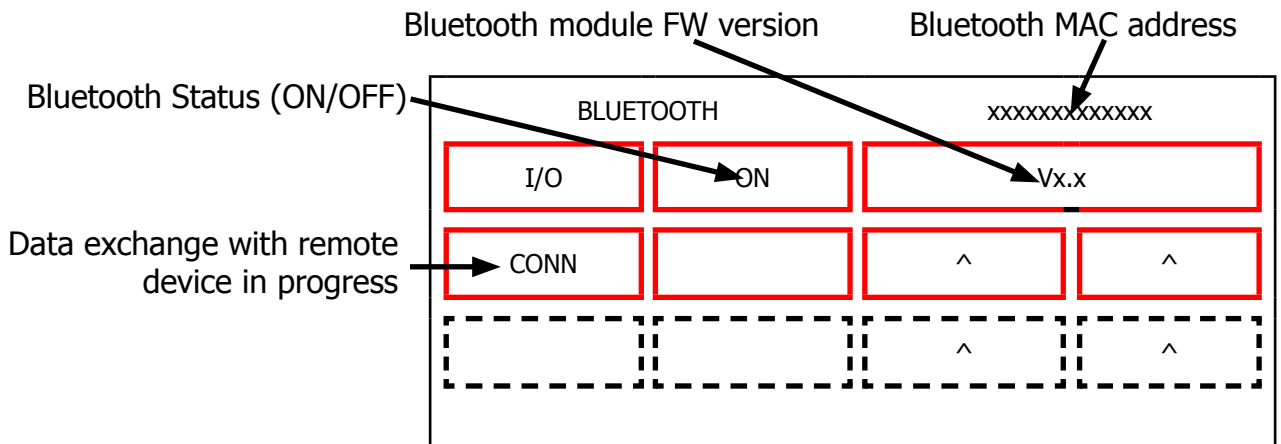

The meaning of the sectors are the following:

Command:

I/O: enable/disable Bluetooth module. Please note that switching OFF the module does not cause an alive connection to break-down. You first need to disconnect the remote device, and then the OFF status makes the CA not anymore detectable to the remote device.

Info:

ON/OFF: status of BT module (if a "-" is shown the communication is NOT OK) .

MAC Address: Mac address of the BT module (every module as a specific MAC address) (if a "-" is shown the communication is NOT OK)

BT Firmware: Firmware version of the BT module (if a "-" is shown the communication is NOT OK)

CONN: when it is lighted up, it means that a remote device is connected and exchanging information with the CA

Press **UP** (^): go to next page

Steam Out

Not mandatory, but if necessary, before executing the steam out procedure, descale the machine taking care to remove the Aquaclean filter from the appliance.

In case the filter on the machine is active (or it's in the machine) provide the consumer with a new one.

This page allow to execute the steam out process:

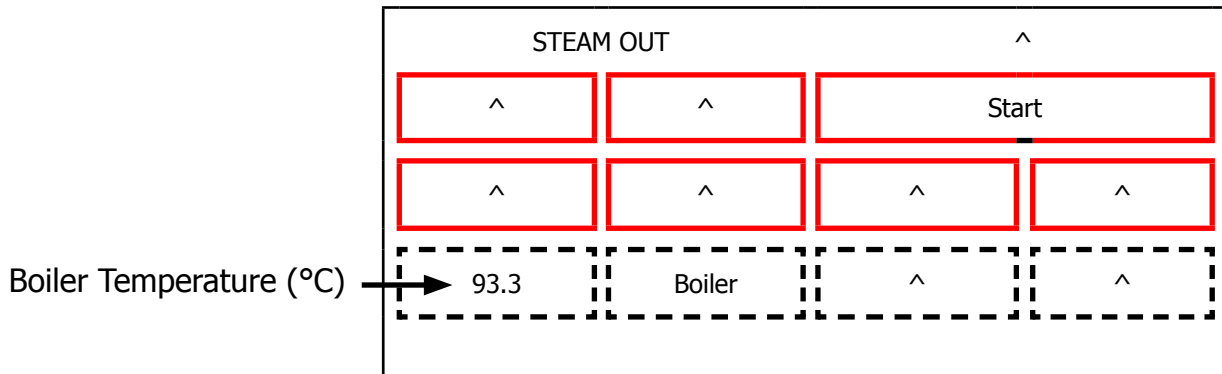

The meaning of the sectors are the following:

Command:

Start: start the steamout process. At the end of process appears: Switch Off at the bottom of the display (so it's possible to restart the machine with the default values)

Info:

Boiler: It's enabled when the boiler is activated

This is the last page of Factory Test Mode. Press **UP** to navigate to precedent page or press **DOWN** to navigate to first page. Press **ESC** to restart the machine.

5.1.2. Diagnostic Mode Gran BaristoV2 and AvantiV2

To enter Diagnostic Mode

When the display turns ON, press the keyboard buttons in the order described below:

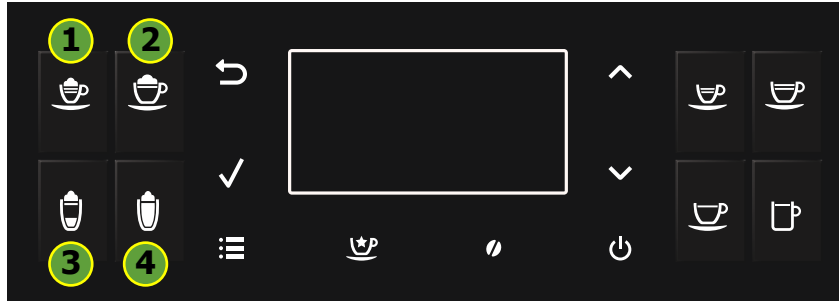

Menu Structure

DIAGNOSTIC MODE		
1. Product counters (default values 0)	Espresso	
	Espresso lungo	
	Cafe Creme	
	Coffee	
	Cappuccino	
	Latte macchiato	
	Froth milk	
	Espresso Macchiato	
	Hot water	
	Ristretto	
	Espresso Mild	
	Espresso Intenso	
	Energy Coffee	
	Flat White	
2. Error counters (default values 0)	2.1. Errors log	Error code
		Error index
		Error text
	2.2. Errors reset	
3. Water counters (default values 0)	3.1. Descaling cycle	Liters since last
		Excess liters since last
		Liters last descale
		Excess liters last descale
		Number of execution
	3.2. Brewing unit cleaning	Number of execution
		Liters since last clean
	3.3. Since production	Liters Coffee/Water
		Liters Steam
	3.4. Water filter	Current Number (default 0)
		Remain. Cc to expire (default 0)
		Total Filter used (default 0)
Total water cc (default 0)		
Remain. Cc startup (default 5000)		

Detailed description of the diagnosis menu

1. Product counters

"**Product counters**" represents the total number of deliveries performed by the machine for each product from the production.

2. Error counters

"**Error counters**" displays the total number of errors "out of service" (fail) occurred in the system (see "**Errors log**"), and allows you to reset the drive (see "**Errors reset**").

The maximum number of "fail" count is 20.

The submenu "**Errors log**" is available only if there is at least one error and, if so, submit the following information:

Error code: is the numerical code for the type of fail has occurred in the system. For example, "Error code E01" is the error with index 1 and is equivalent to the Grinder blocked.

Error index: represents the numeric position of the error in the internal list.

The maximum number of elements in the list is 20: the list is handled in a circular fashion, that is, the data in the first position is always the last error that occurred in order of time (eg 01/07 means that you are reading the most recent error on a total of 7 errors).

Error text: is the text description of the type of error that occurred in the system.

For example: "**Grinder blocked.**"

The cancellation of the error list by "**Errors reset**", as it deletes all information relating thereto, also prevents access to the menu under "**Errors log**".

List of possible errors of "**out of service**":

Grinder blocked (E01): occurs if the grinder is to have the mills blocked.

In this case, the machine stops the instant the user asks for the machine to dispense a drink made of coffee (just coffee beans).

Brewing unit blocked work (E03): occurs when the brew unit can not move from location to location work home.

Brewing unit blocked home (E04): occurs when the brew unit can not move from the home position to the work position.

Water circuit interrupted (E05): occurs when the flow meter is faulty, disconnected or does not occur passage of water. In these cases, since the machine fails to correctly read the pulses of water, enters alarm condition "CHARGING CIRCUIT" in the moment in which the user asks to dispense a product:

if the "charging circuit" the machine supply fails block. This total.

DC Valve short circuit (E06): occurs when one of the valves of the flute is short-circuited. This problem may occur during the delivery of a product based on milk.

Coffee temp. sensor short circuit (E10): occurs when the temperature of the coffee boiler sensor is short-circuited. This error causes a total shutdown of the machine to start up.

Coffee temp. sensor open circuit (E11): occurs when the temperature of the coffee boiler sensor is not detected. The problem is due to the absence of the signal of the sensor and does not allow the machine to establish the actual temperature of the coffee boiler.
At start up, the machine enters the halt.

Boiler coffee timeout (E14): occurs when no power coming to the coffee boiler, this does not reach the preset temperature within a time of 2 minutes.

At start up the machine remains long in the screen WAITING READY TEMPERATURE, with the message "Warming up ...", and after the expiry of the time goes to lock out.

Zero crossing error (E19): occurs when the machine does not detect the signal zero crossing.

Coffee boiler overheating (E20): occurs when the temperature of the coffee boiler and exceeds 170 ° C.

BU encoder error (E24): occurs when the machine is not correctly detect the signal of the encoder

3. Water counters

"**Water counters**" shows water consumption (in liters) following delivery of products, the descaling cycle, the cleaning cycle the activation group and filter.

The submenu "Descaling cycle" has the following items:

Liters since last: represents the total number of gallons of water consumed since the last descaling cycle. It is reset after the complete execution of the descaling cycle.

Excess liters since last: represents the number of liters of water consumed in excess since the Machine signals the descaling indicator.

It is reset after the complete execution of the descaling cycle.

Liters last descale: represents the total number of gallons of water consumed until the last descaling cycle.

Takes the value of "Liters since last" after the complete execution of the descaling cycle.

Excess liters last descale: represents the number of liters of water consumed in excess since the machine reported the descaling indicator until the last descaling cycle.

Takes the value of "Excess liters since last" after the complete execution of the descaling cycle.

Number of execution: represents the number of cycles executed on the machine descaling.

The sub-menu "**Brewing unit cleaning**" has the following items:

Number of execution: represents the number of cleaning cycles (liters) performed on the machine group.

Liters since last clean: represents the total number of liters of water consumed since the last cleaning cycle group. It is reset after the execution of a complete cleaning cycle group

The submenu "**Water filter**" has the following items:

Current Number: Current Number: current number of filter within the process chain longevity. It can range from 0 to 8.

Remain. Cc to expire: Autonomy of the filter, so the amount of water in cc remaining before the expiry of the filter.

Total Filter used: total number of filters turned on the machine

Total water cc: total amount of water, in cc, which has gone through the machine with active filters and unexpired.

Remain. Cc startup: counter of the remaining water, expressed in cc, for the activation of the first filter of the chain (1/8) . It goes from 5000 to zero: the first filter must be activated before the counter reaches zero, otherwise it will be necessary to descale before activating the filter.

"Dreg alarm": indicates the value at which the counter is reset funds to indicate the alarm funds.

"Dreg counter" represents funds that the counter is initialized to the value of "Dreg alarm" to any empty the drawer bottoms and decremented by a value depending on the dose in the ground made products. When is 0 the machine will display the alarm drain funds.

The item "**Since production**" has the following items:

Liters Coffee/Water: It represents the total number of liters of water consumed during the execution of products coffee (or part mixed coffee) or water.

Liters Steam: It represents the total number of liters of water consumed during the execution of milk products (milk or mixed part).

5.1.3. Error codes

ERROR CODES	DESCRIPTION
01	Grinder blocked
03	Brewing UNIT blocked work
04	Brewing UNIT blocked home
05	Water circuit interrupted
06	DC valve short circuit
10	Coffee temp. sensor short circuit
11	Coffee temp. sensor open circuit
14	Boiler coffee timeout
19	Zero crossing error
20	Boiler coffee overheating
24	BU Encoder Error

5.2.1. Test Mode Gran Baristo Avanti

To enter Test Mode

When the display turns ON, press the keyboard buttons in the order described below:

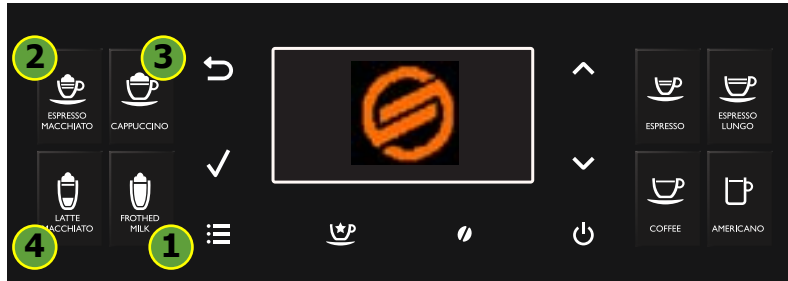

Description

When the machine is in Factory Test Mode appears a windows divided in several sectors:

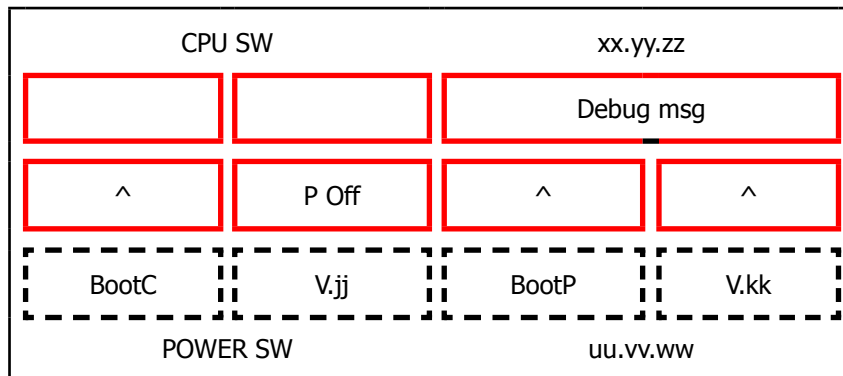

The first row of each window is a title, the red sectors represents the functions (or loads) available to activate or deactivate, the last row is used to show other info. When a function is enabled the corresponding box becomes colored. The dotted sectors is used to show informations about the status of microswitch, sensors or other variables.

The presence of symbol (^) into a sector indicate that no function is associated to.

The following image show the corrispondence between the keyboard and red sectors:

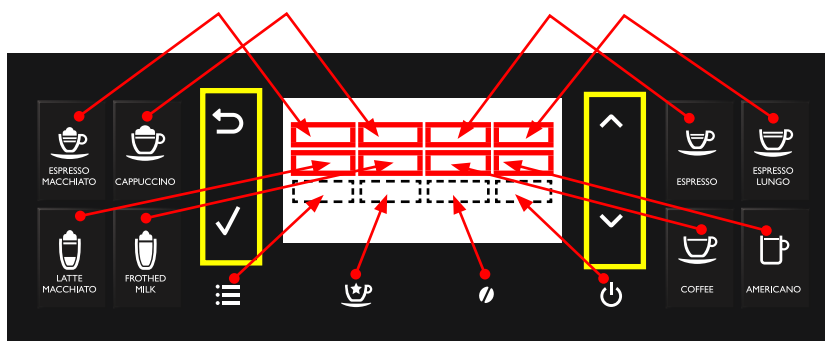

The keyboard buttons (ESC, OK, UP and DOWN), highlighted in yellow, have the following functions:

UP : go to next page

DOWN : go to previous page

OK (✓): confirm / enable / disable function

ESC (↵) : exit from Factory Test Mode

Activation of loads

In Test Mode all loads are initially disabled.

To activate a load press the corresponding button on keyboard, to deactivate press again the same button.

Other conditions for which a load may be switched off automatically without key presses are:

- If it is defined a working cycle, when this cycle ends (such as the grinder or brew unit)
- The achievement of 90°C for boiler

Navigation in Test Mode

SoftwareVersion

This is the first window of Factory Test Mode. It show the version of CPU software and CPU bootloader version, the PWR software and PWR bootloader version and is possible to activate or deactivate the POff feature and Debug info.

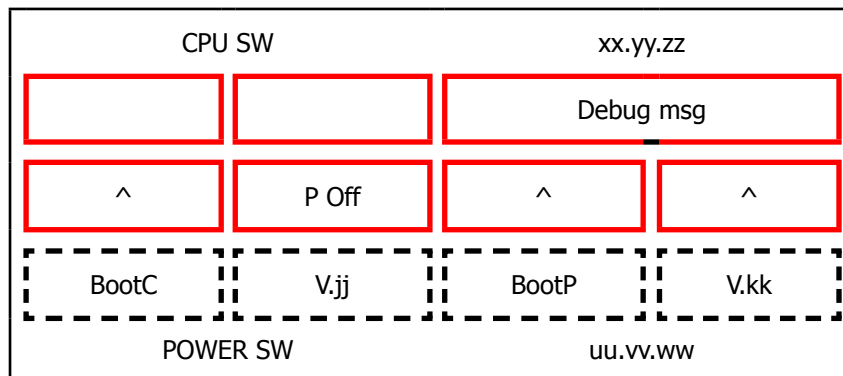

Press **OK (✓)** button to modify one of the following feature:

Debug msg: if enabled (colored box), only for next startup, allows the visualization of the following debug info on display in Ready state:

Grinder Time Aroma 1 (msec)	Encoder Pulses Home Work About Last Cycle	Encoder Dreg Counter: 4000 ->dreg drawer empty 0-> dreg drawer full	Grinder Time Aroma 4 (msec)
Grinder Time Aroma 2 (msec)			Grinder Time Aroma 5 (msec)
Grinder Time Aroma 3 (msec)			Grinder Time Aroma 6 (msec)
	Encoder Pulses from HOME to Pod Pressure about Last Cycle	Target Encoder Pulses from HOME to Pod Pressure about last Cycle	

P Off: if enabled (colored box), allows the machine to enter in standby mode immediately after powering ON from the main switch.

Make sure that the function **P Off** is turned ON and the **Debug msg** is turned OFF.

Press **UP (∧)**: go to next page

Keyboard

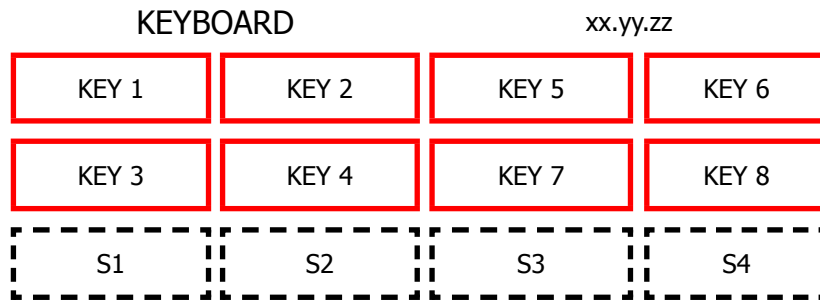

This page allow to test each button of keyboard (is shown its version) with the following correspondence:

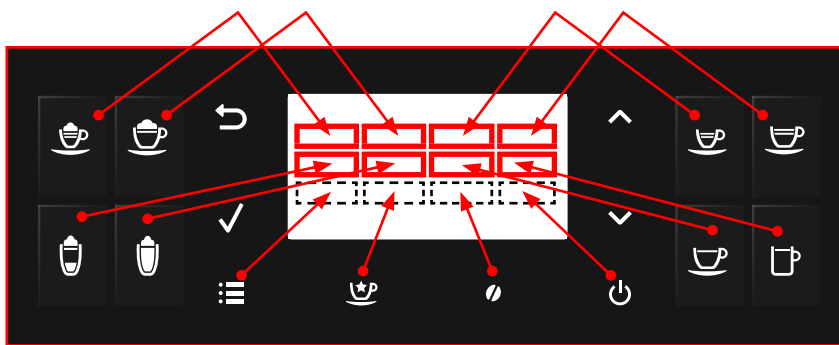

When is pressed a button the corresponding box becomes with background colored and the led of keyboard is turned ON, if it is pressed again becomes with black background and the led of keyboard is turned OFF(except for UP, DOWN and ESC that are always turned ON).

Press **UP** (^): go to next page

Brew Unit

This page allow to test the functionality of Brew Unit, BU Encoder, frontal door and dreg drawer:

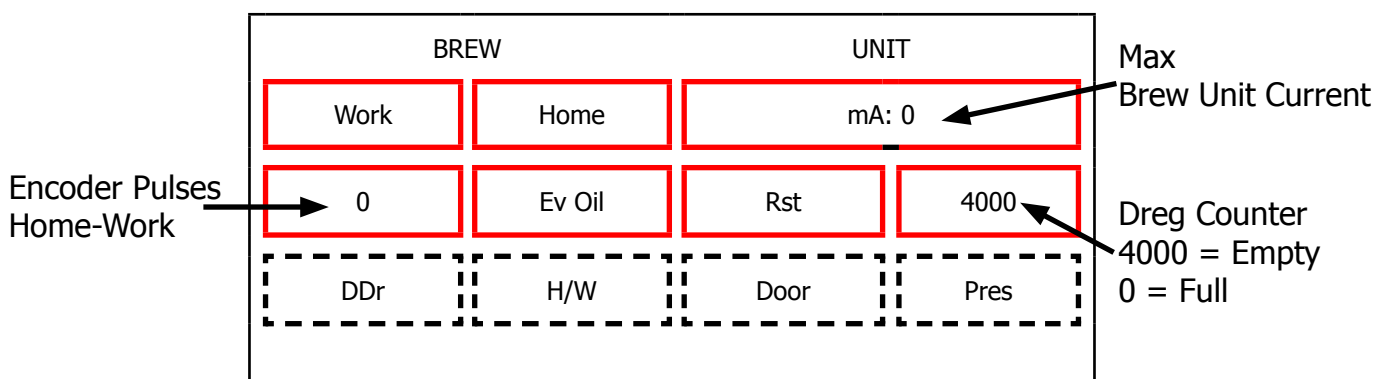

The meaning of the sectors are the following:

Command:

Work: when pressed move the brew unit to WORK

Home: when pressed move the brew unit to HOME

Ev Oil: when pressed activate/deactivate the Oil electrovalve (24V Dc)

Rst: when pressed move the brew unit in RESET(extraction) position(stop the brew unit if was in movement)

Info:

mA: indicates the maximum current (in mA) absorbed by the brew unit in motion. The value must not exceed the following values:

- 600 mA with new the brew unit
- 450 mA with a brew unit with at least 5 product executed
- 130 mA without brew unit

Encoder Pulses Home-Work: indicate the number of encoder pulses from Home to Work position or vice versa. Move the brew unit from Home to work or vice versa and the measured value must be in the range [2000 – 2100].

H/W: Becomes active when the Brew Unit reach HOME or WORK position

Pres: Becomes active if the Brew Unit is present in machine

DDr: Becomes active if the Dreg Drawer is present in machine

Door: Becomes active if the Frontal Door is closed

Press **UP (^)**: go to next page

Hydraulic Circuit

This page allow to test the functionality of hydraulic circuit:

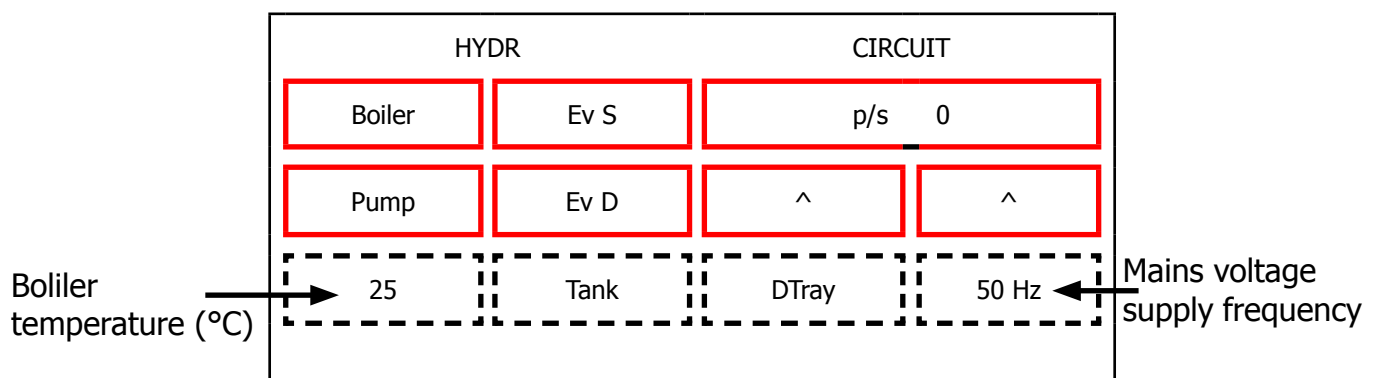

The meaning of the sectors are the following:

Command:

Boiler: when pressed activate/deactivate the boiler if the temperature is less than 90°C

Pump: when pressed activate/deactivate the pump

Ev S: when pressed activate/deactivate the Steam/Water electrovalve (24V Dc)

Ev D: when pressed activate/deactivate the discharge electrovalve (24V Dc)

Info:

p/s: indicate the current number of water flow expressed in pulses/sec. When is activated the pump and one electrovalve the value measured must be equal to or greater than 10 p/s.

Tank: Becomes active when the water into tank reach sensor level

DripTray: Becomes active when the water into drip tray reach sensor level

Frequency: indicate the frequency of mains voltage supply

Boiler Temperature: indicate the boiler temperature in °C

Press **UP (^)**: go to next page

Grinder

This page allow to test the functionality of grinder:

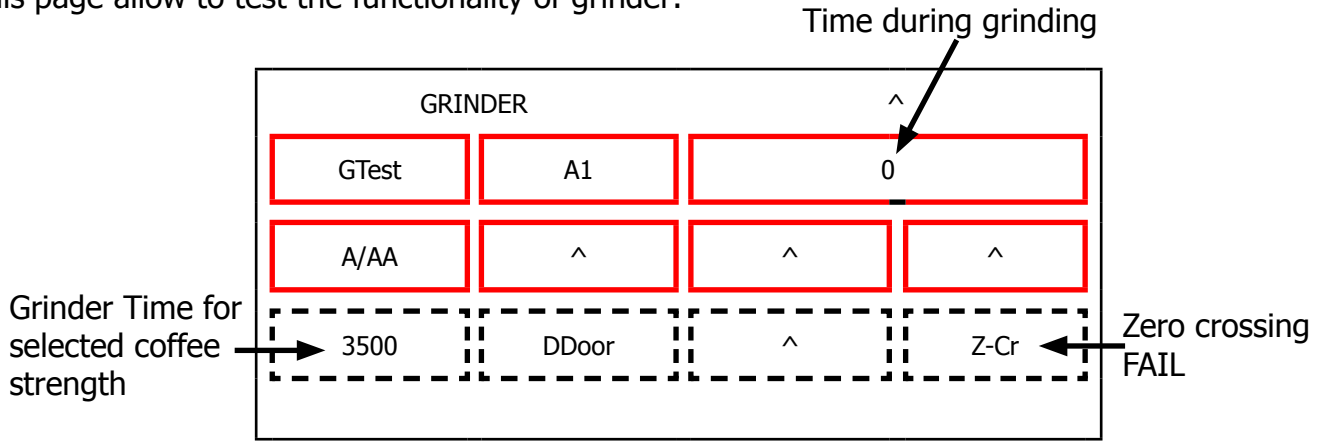

The meaning of the sectors are the following:

Command:

A1: Selected Coffee Strength. If pressed change the current coffee strength from A1 to A6

A1: Very Mild

A2: Mild

A3: Regular

A4: Strong

A5: Very Strong

A6: Extra Strong

A/AA: A = use the current coffee strength ; AA = add 33% of time to the current coffee strength

GTest: Activate/Deactivate the grinder for a time corresponding to the selected coffee strength.

Info:

Time during grinding: indicate the time while the machine is grinding in msec

DDOOR: indicate the status of hopper door (colored box -> closed)

Z-cr: Colored box indicate that the measure of zero crossing is FAIL.

Press **UP** (^): go to next page

Display

This page allow to change display settings (brightness and contrast):

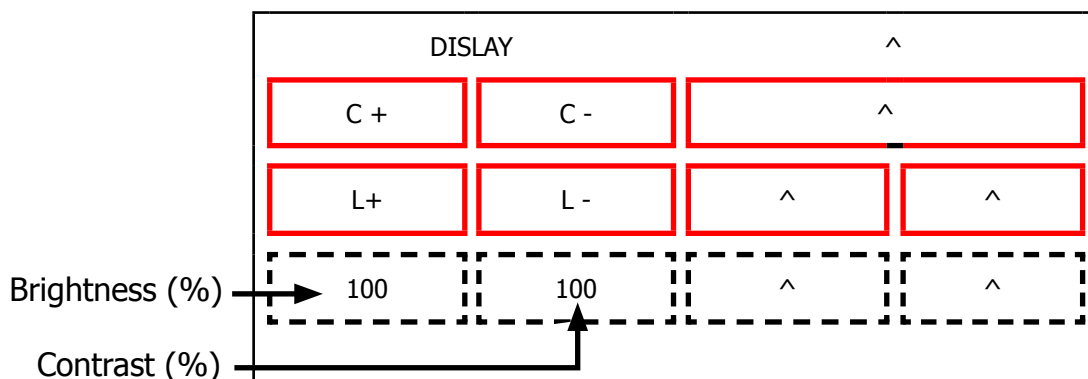

The meaning of the sectors are the following:

Command:

C+: increase the display contrast

C- : decrease the display contrast

L+: increase the display brightness

L- : decrease the display brightness

Bluetooth

This page allow to check the BT module

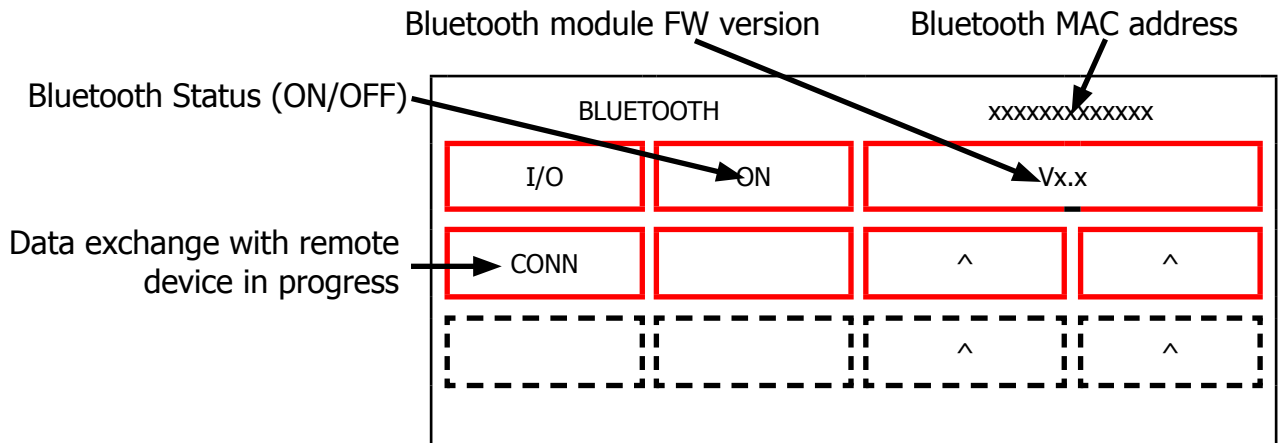

The meaning of the sectors are the following:

Command:

I/O: enable/disable Bluetooth module. Please note that switching OFF the module does not cause an alive connection to break-down. You first need to disconnect the remote device, and then the OFF status makes the CA not anymore detectable to the remote device.

Info:

ON/OFF: status of BT module (if a "-" is shown the communication is NOT OK) .

MAC Address: Mac address of the BT module (every module as a specific MAC address) (if a "-" is shown the communication is NOT OK)

BT Firmware: Firmware version of the BT module (if a "-" is shown the communication is NOT OK)

CONN: when it is lighted up, it means that a remote device is connected and exchanging information with the CA

Press **UP** (**^**): go to next page

Steam Out

This page allow to execute the steam out process:

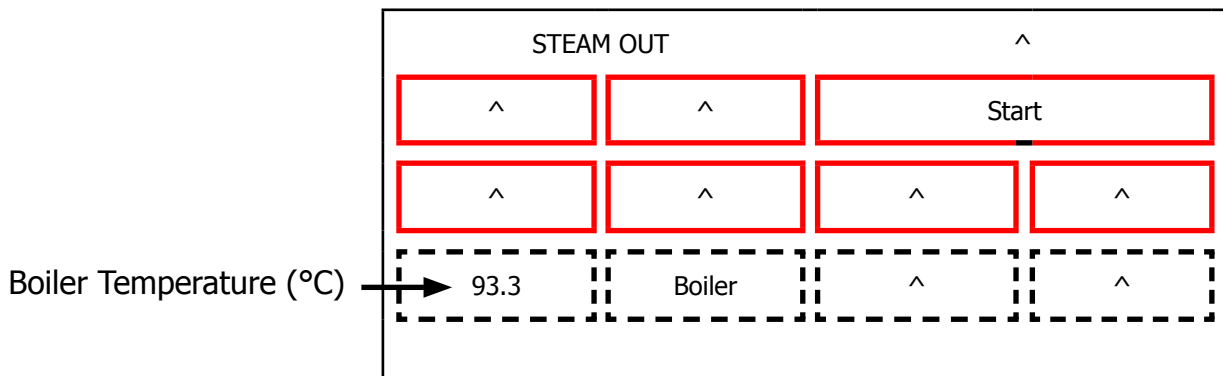

The meaning of the sectors are the following:

Command:

Start: start the steamout process. At the end of process appears: Switch Off at the bottom of the display (so it's possible to restart the machine with the default values)

Info:

Boiler: It's enabled when the boiler is activated

This is the last page of Factory Test Mode. Press **UP** to navigate to precedent page or press **DOWN** to navigate to first page. Press **ESC** to restart the machine.

5.2.2. Test Mode Gran Baristo

To enter Test Mode

When the display turns ON, press the keyboard buttons in the order described below:

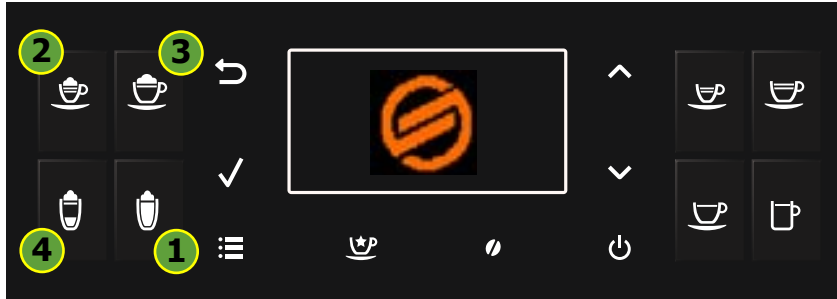

Description

When the machine is in Factory Test Mode appears a windows divided in several sectors:

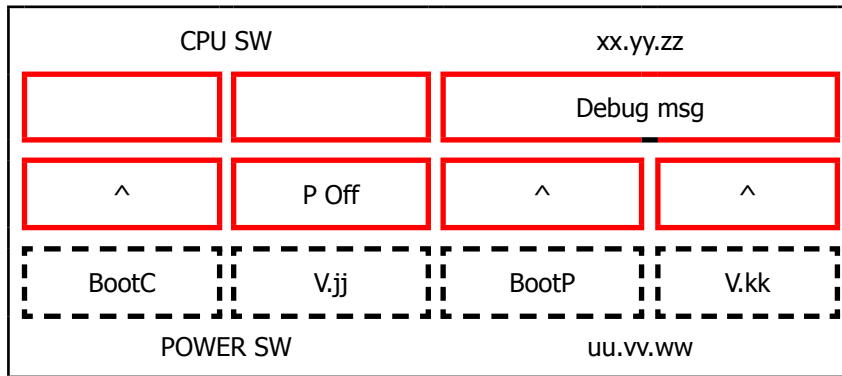

The first row of each window is a title, the red sectors represents the functions (or loads) available to activate or deactivate, the last row is used to show other info. When a function is enabled the corresponding box becomes colored. The dotted sectors is used to show informations about the status of microswitch, sensors or other variables.

The presence of symbol (^) into a sector indicate that no function is associated to.

The following image show the correspondance between the keyboard and red sectors:

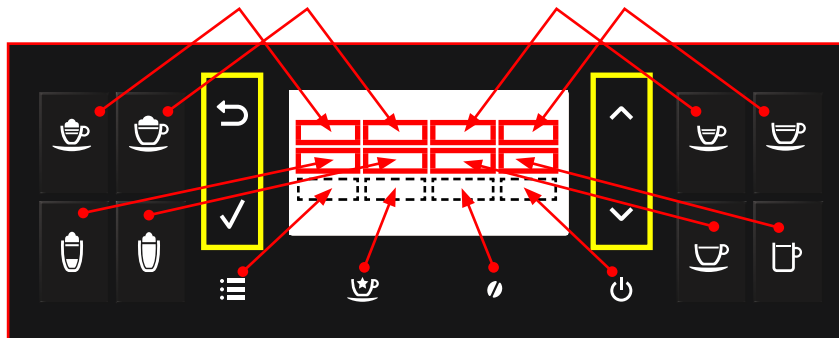

The keyboard buttons (ESC, OK, UP and DOWN), highlighted in yellow, have the following functions:

UP : go to next page

DOWN : go to previous page

OK (✓): confirm / enable / disable function

ESC (↵) : exit from Factory Test Mode

Activation of loads

In Test Mode all loads are initially disabled.

To activate a load press the corresponding button on keyboard, to deactivate press again the same button.

Other conditions for which a load may be switched off automatically without key presses are:

- If it is defined a working cycle, when this cycle ends (such as the grinder or brew unit)
- The achievement of 90°C for boiler

Navigation in Test Mode

SoftwareVersion

This is the first window of Factory Test Mode. It show the version of CPU software and CPU bootloader version, the PWR software and PWR bootloader version and is possible to activate or deactivate the POff feature and Debug info.

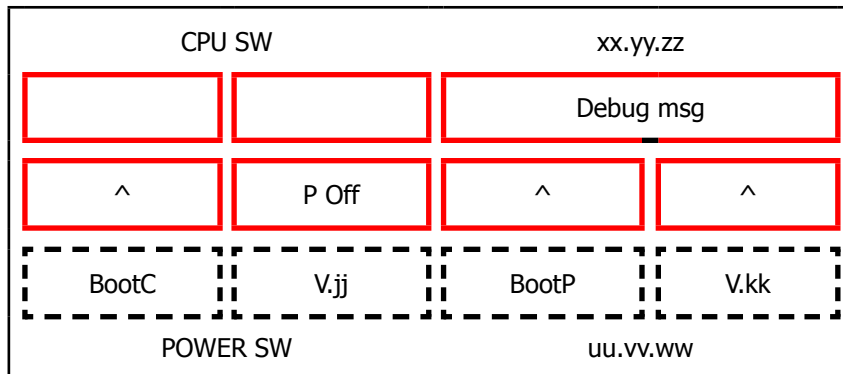

Press **OK (✓)** button to modify one of the following feature:

Debug msg: if enabled (colored box), only for next startup, allows the visualization of the following debug info on display in Ready state:

Grinder Time Aroma 1 (msec)	Encoder Pulses Home Work About Last Cycle	Encoder Dreg Counter: 4000 ->dreg drawer empty 0-> dreg drawer full	Grinder Time Aroma 4 (msec)
Grinder Time Aroma 2 (msec)			Grinder Time Aroma 5 (msec)
Grinder Time Aroma 3 (msec)			Grinder Time Aroma 6 (msec)
	Encoder Pulses HOME to Pod Pressure About Last Cycle	Target Encoder Pulses from HOME to Pod Pressure about last Cycle	

P Off: if enabled (colored box), allows the machine to enter in standby mode immediately after powering ON from the main switch.

Make sure that the function **P Off** is turned ON and the **Debug msg** is turned OFF.

Press **UP (∧)**: go to next page

Keyboard

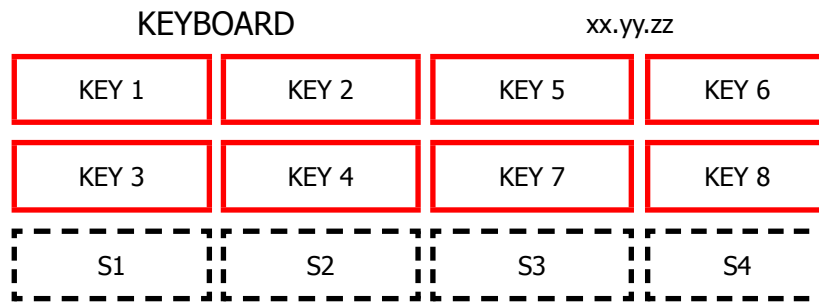

This page allow to test each button of keyboard (is shown its version) with the following correspondence:

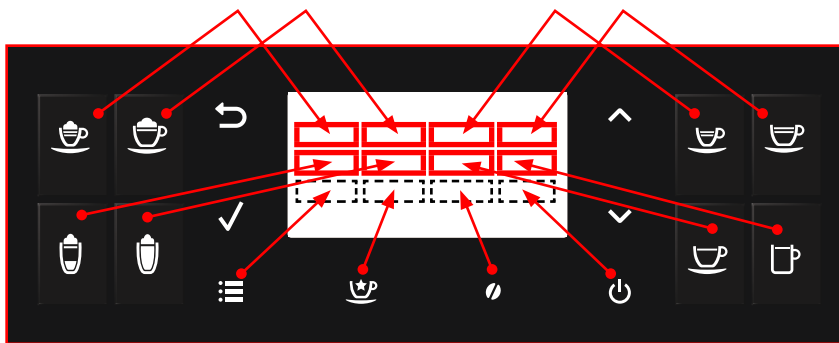

When is pressed a button the corresponding box becomes with background colored and the led of keyboard is turned ON, if it is pressed again becomes with black background and the led of keyboard is turned OFF(except for UP, DOWN and ESC that are always turned ON).

Press **UP** (^): go to next page

Brew Unit

This page allow to test the functionality of Brew Unit, BU Encoder, frontal door and dreg drawer:

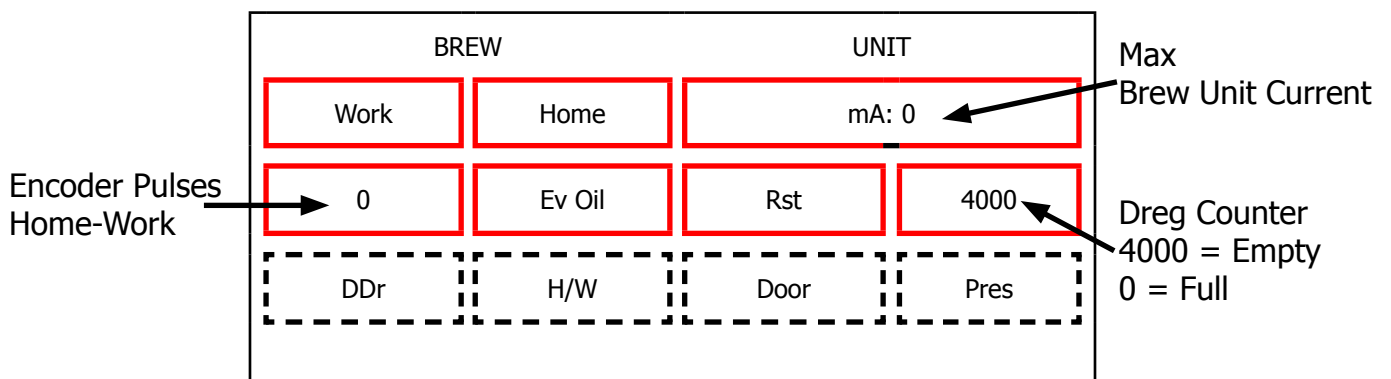

The meaning of the sectors are the following:

Command:

Work: when pressed move the brew unit to WORK

Home: when pressed move the brew unit to HOME

Ev Oil: when pressed activate/deactivate the Oil electrovalve (24V Dc)

Rst: when pressed move the brew unit in RESET(extraction) position(stop the brew unit if was in movement)

Info:

mA: indicates the maximum current (in mA) absorbed by the brew unit in motion. The value must not exceed the following values:

- 600 mA with new the brew unit
- 450 mA with a brew unit with at least 5 product executed
- 130 mA without brew unit

Encoder Pulses Home-Work: indicate the number of encoder pulses from Home to Work position or vice versa. Move the brew unit from Home to work or vice versa and the measured value must be in the range [2000 – 2100].

H/W: Becomes active when the Brew Unit reach HOME or WORK position

Pres: Becomes active if the Brew Unit is present in machine

DDr: Becomes active if the Dreg Drawer is present in machine

Door: Becomes active if the Frontal Door is closed

Press **UP** (**^**): go to next page

Hydraulic Circuit

This page allow to test the functionality of hydraulic circuit:

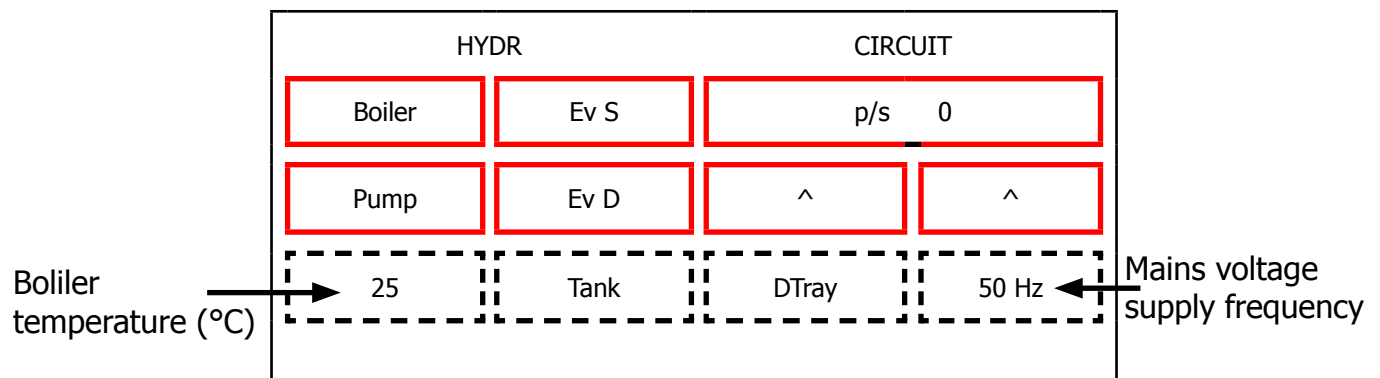

The meaning of the sectors are the following:

Command:

Boiler: when pressed activate/deactivate the boiler if the temperature is less than 90°C

Pump: when pressed activate/deactivate the pump

Ev S: when pressed activate/deactivate the Steam/Water electrovalve (24V Dc)

Ev D: when pressed activate/deactivate the discharge electrovalve (24V Dc)

Info:

p/s: indicate the current number of water flow expressed in pulses/sec. When is activated the pump and one electrovalve the value measured must be equal to or greater than 10 p/s.

Tank: Becomes active when the water into tank reach sensor level

DripTray: Becomes active when the water into drip tray reach sensor level

Frequency: indicate the frequency of mains voltage supply

Boiler Temperature: indicate the boiler temperature in °C

Press **UP** (**^**): go to next page

Grinder

This page allow to test the functionality of grinder:

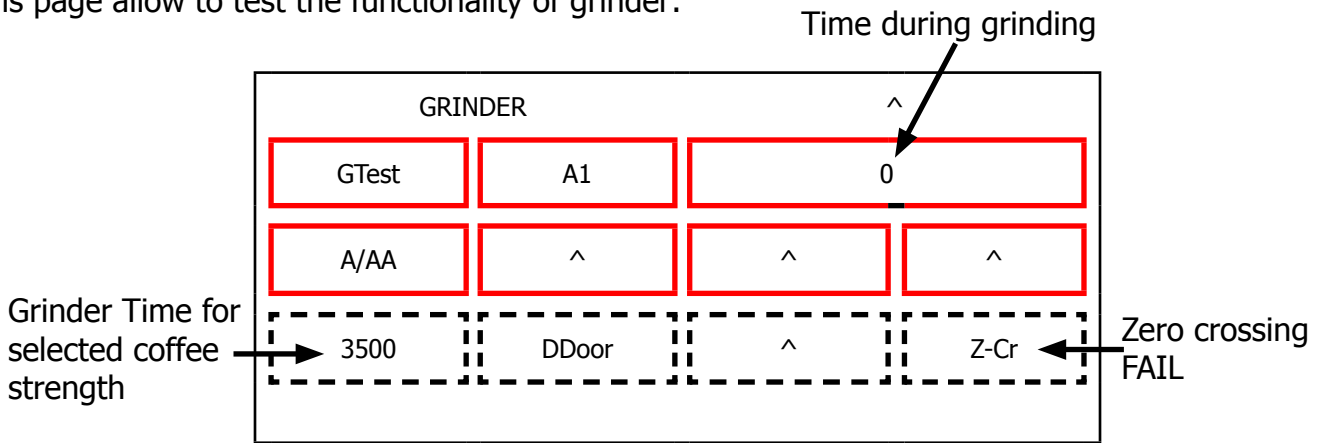

The meaning of the sectors are the following:

Command:

A1: Selected Coffee Strength. If pressed change the current coffee strength from A1 to A6

A1: Very Mild

A2: Mild

A3: Regular

A4: Strong

A5: Very Strong

A6: Extra Strong

A/AA: A = use the current coffee strength ; AA = add 33% of time to the current coffee strength

GTest: Activate/Deactivate the grinder for a time corresponding to the selected coffee strength.

Info:

Time during grinding: indicate the time while the machine is grinding in msec

DDOOR: indicate the status of hopper door (colored box -> closed)

Z-cr: Colored box indicate that the measure of zero crossing is FAIL.

Press **UP (^)**: go to next page

Display

This page allow to change display settings (brightness and contrast):

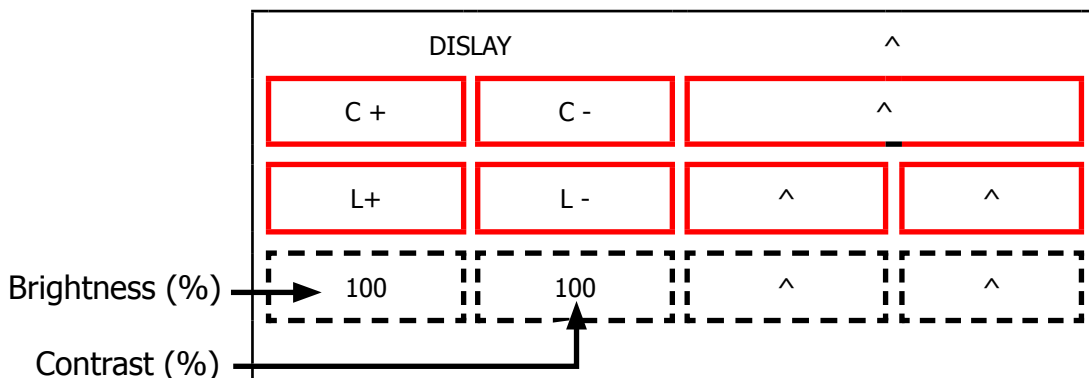

The meaning of the sectors are the following:

Command:

C+: increase the display contrast

C- : decrease the display contrast

L+: increase the display brightness

L- : decrease the display brightness

Press **UP** (**^**): go to next page

Steam Out

This page allow to execute the steam out process:

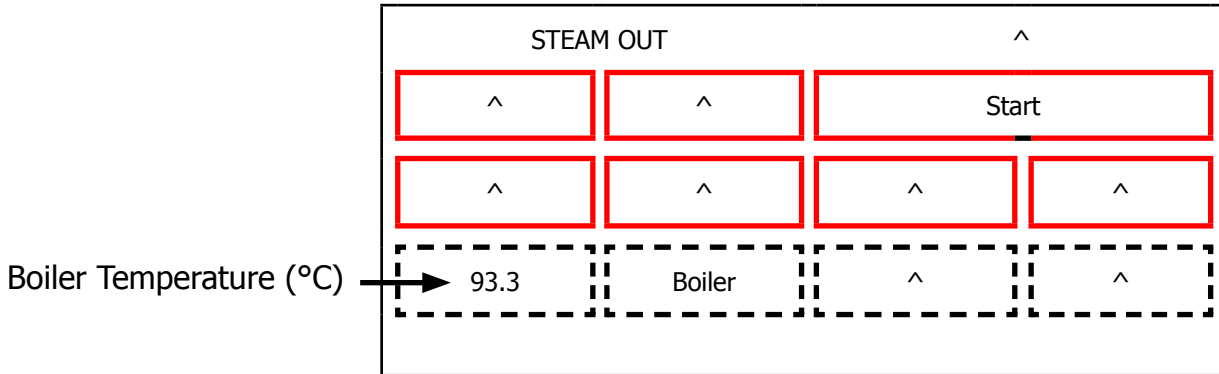

The meaning of the sectors are the following:

Command:

Start: start the steamout process. At the end of process appears: Switch Off at the bottom of the display (so it's possible to restart the machine with the default values)

Info:

Boiler: It's enabled when the boiler is activated

This is the last page of Factory Test Mode. Press **UP** to navigate to precedent page or press **DOWN** to navigate to first page. Press **ESC** to restart the machine.

5.2.3. Diagnostic Mode Gran Baristo/Gran Baristo Avanti

To enter Diagnostic Mode

When the display turns ON, press the keyboard buttons in the order described below:



Menu Structure

DIAGNOSTIC MODE		
1. Product counters (default values 0)	Espresso	
	Caffè	
	Cafe Creme	
	Hot water	
	Cappuccino	
	Latte macchiato	
	Hot milk	
	American Coffee	
	Espresso Macchiato	
	Ristretto	
	Espresso Mild	
	Espresso Intenso	
	Energy Coffee	
	Cafe Au Lait	
2. Error counters (default values 0)	2.1. Errors log	Error code
		Error index
		Error text
2.2. Errors reset		
3. Water counters (default values 0)	3.1. Descaling cycle	Liters since last
		Excess liters since last
		Liters last descale
		Excess liters last descale
		Number of execution
	3.2. Brewing unit cleaning	Number of execution
		Liters since last clean
	3.3. Since production	Liters Coffee/Water
		Liters Steam
	3.4. Water filter	Liters since last reset
Number of reset		

Detailed description of the diagnosis menu

1. Product counters

"**Product counters**" represents the total number of deliveries performed by the machine for each product from the production.

2. Error counters

"**Error counters**" displays the total number of errors "out of service" (fail) occurred in the system (see "**Errors log**"), and allows you to reset the drive (see "**Errors reset**").

The maximum number of "fail" count is 20.

The submenu "**Errors log**" is available only if there is at least one error and, if so, submit the following information:

Error code: is the numerical code for the type of fail has occurred in the system. For example, "Error code E01" is the error with index 1 and is equivalent to the Grinder blocked.

Error index: represents the numeric position of the error in the internal list.

The maximum number of elements in the list is 20: the list is handled in a circular fashion, that is, the data in the first position is always the last error that occurred in order of time (eg 01/07 means that you are reading the most recent error on a total of 7 errors).

Error text: is the text description of the type of error that occurred in the system.

For example: "**Grinder blocked.**"

The cancellation of the error list by "**Errors reset**", as it deletes all information relating thereto, also prevents access to the menu under "**Errors log**".

List of possible errors of "**out of service**":

Grinder blocked (E01): occurs if the grinder is to have the mills blocked.

In this case, the machine stops the instant the user asks for the machine to dispense a drink made of coffee (just coffee beans).

Brewing unit blocked work (E03): occurs when the brew unit can not move from location to location work home.

Brewing unit blocked home (E04): occurs when the brew unit can not move from the home position to the work position.

Water circuit interrupted (E05): occurs when the flow meter is faulty, disconnected or does not occur passage of water. In these cases, since the machine fails to correctly read the pulses of water, enters alarm condition "CHARGING CIRCUIT" in the moment in which the user asks to dispense a product:

if the "charging circuit" the machine supply fails block. This total.

DC Valve short circuit (E06): occurs when one of the valves of the flute is short-circuited. This problem may occur during the delivery of a product based on milk.

Coffee temp. sensor short circuit (E10): occurs when the temperature of the coffee boiler sensor is short-circuited. This error causes a total shutdown of the machine to start up.

Coffee temp. sensor open circuit (E11): occurs when the temperature of the coffee boiler sensor is not detected. The problem is due to the absence of the signal of the sensor and does not allow the machine to establish the actual temperature of the coffee boiler. At start up, the machine enters the halt.

Boiler coffee timeout (E14): occurs when no power coming to the coffee boiler, this does not reach the preset temperature within a time of 2 minutes.

At start up the machine remains long in the screen WAITING READY TEMPERATURE, with the message "Warming up ...", and after the expiry of the time goes to lock out.

Zero crossing error (E19): occurs when the machine does not detect the signal zero crossing.

Coffee boiler overheating (E20): occurs when the temperature of the coffee boiler and exceeds 170 ° C.

BU encoder error (E24): occurs when the machine is not correctly detect the signal of the encoder

3. Water counters

"Water counters" shows water consumption (in liters) following delivery of products, the descaling cycle, the cleaning cycle the activation group and filter.

The submenu "Descaling cycle" has the following items:

Liters since last: represents the total number of gallons of water consumed since the last descaling cycle. It is reset after the complete execution of the descaling cycle.

Excess liters since last: represents the number of liters of water consumed in excess since the car signals the descaling indicator.

It is reset after the complete execution of the descaling cycle.

Liters last descale: represents the total number of gallons of water consumed until the last descaling cycle.

Takes the value of "Liters since last" after the complete execution of the descaling cycle.

Excess liters last descale: represents the number of liters of water consumed in excess since the car reported the descaling indicator until the last descaling cycle.

Takes the value of "Excess liters since last" after the complete execution of the descaling cycle.

Number of execution: represents the number of cycles executed on the machine descaling.

The sub-menu **"Brewing unit cleaning"** has the following items:

Number of execution: represents the number of cleaning cycles performed on the machine group.

Liters since last clean: represents the total number of gallons of water consumed since the last cleaning cycle group. It is reset after the execution of a complete cleaning cycle group

The submenu "**Water filter**" has the following items:

Since last reset: represents the total number of gallons of water from the last cycle of activation filter.

It is reset after the execution of the cycle of activation filter.

Number of reset: represents the number of cycles performed activation filter on the machine

The item "**Since production**" has the following items:

Liters Coffee / Water represents the total number of liters of water consumed during the execution of coffee products (or the mixed coffee) or water.

Liters Steam represents the total number of liters of water consumed during the execution of milk products (milk or mixed part).

4. Grinding auto dose

The submenu "**Grinding timer**" indicates for each flavor (Dose 1 Dose ... 6) the grinding time in msec.

These values evolve over time depending on the technique of 'autodose'.

The submenu "**Encoding strength**" indicates the multiplicative constants used to calculate the expected volume of each flavor (multiplicative constant * gr = number of encoder pulses relative to the volume of the aroma: es: aroma 1 -> $44 * 5 = 220$).

The submenu "**Bean lack alarm**" indicates for each flavor the minimum number of encoder pulses (volume of the pad) that allows you to not give the alarm without coffee.

The submenu "Dregdrawer alarm" has the following items:

"Dreg alarm": indicates the value at which the counter is reset funds to indicate the alarm funds.

"Dreg counter" represents funds that the counter is initialized to the value of "Dreg alarm" to any empty the drawer bottoms and decremented by a value depending on the dose in the ground made products. When is 0 the machine will display the alarm drain funds.

5.2.4. Error codes

ERROR CODES	DESCRIPTION
01	Grinder blocked
03	Brewing UNIT blocked work
04	Brewing UNIT blocked home
05	Water circuit interrupted
06	DC valve short circuit
10	Coffee temp. sensor short circuit
11	Coffee temp. sensor open circuit
14	Boiler coffee timeout
19	Zero crossing error
20	Boiler coffee overheating
24	BU Encoder Error

5.3. Saeco Service Center - Quick Start Guide

Saeco Service Center (SSC) is a tool with which you can re-program the machine and check the diagnostic of the same.

You can download the software from the following link: <http://logsave.logtronics.com/SSC2/publish.htm>

In support of this tool it is essential to order the Saeco Programming Device:

Cod. 20000490 "KIT PROGRAMMER SERKIT SSC2".

This kit includes the programmer and cables helpful.

All details related to the registration and operation are explained in the enclosed Quick start guide (QSG).

[Saeco Service Center – Quick Start Guide](#)

Press the icon to view the document 

To open the attached document is necessary to save the service manual on your PC.

CHAPTER 6

REVICING AND MAINTENANCE

6.1. Repair Flow

Proces stap	Saeco no.	Action	
Intake	1	Visual inspection (transport damage) take care for pictures	
	2	Check Type/serialnumber Log all available accessory	
	3	Check product for consumer complaint (NFF contact consumer)	
Diagnosis	4	Opening machine Run Diagnostic to get error codes and relevant set statistics (Saeco Service Center SSC)	
	5	Visual inspection check for loosen parts, leaking etc..	
	6	Operational tests	
	7	Repairing the faults encountered Checking any modifications (view Symptom Cure, new software, etc.)	
Repair	8	Refer Annex tabs per family	
	9	<i>Service activities in accordance with the operating schedule</i> <i>Check/Replace Waterfilter (the small filter, not the Britta filter)</i> <i>Check/Replace Water tank lip seal</i> <i>Check/Replace Boiler pin O-ring</i> <i>Clean/align Coffee grinder (Vacuum cleaner / brush)</i> <i>Descal the water Circuit</i> <i>Check/Replace Hot water/steam valve</i>	
	10	<i>Internal check / cleaning</i> <i>Check/Clean/Grease Brewing unit</i>	
	11	Operational test while the appliance is open Check Hoses, attachments and Oetiker clamps Check Pump for operation & noise Check Gear motor for operation & noise Check for leakage	
	12	Assembly	
	13	Final inspection test Steam out before shipping out, if temperature is below 0° to prevent any damaged due to frozen water.	
	14	No need for those families Minuto family (all platform); Incanto family new; Pico Baristo; Gran Baristo; Intelia V2; Philips 2000-2100; Incanto Executive; Moltio family (all platform). Please also check for GDA_113455	
	15	Provide precise IRIS code, according dedicated code table for Coffee products. The location code from the part you have worked on MUST be completed always with the part reference from exploded view !	
	Inspection visual		Do cabinet parts fit well together Check for damages
		Power check	Will the set switch on
		Accessoires	Do the accessories match with the intake
		Consumer complaint	Check the product for the consumer complaint
	Coffee		Basic Functional test
	Dispense		Make 2 * coffee. Are both amounts equal
			Make e 2 cups at the same time. Are the volumes equal
Noise		Is the sound normal	
Crema		Blow on the coffee. Does the crema come back together	
		Is the crema colour correct (Hazelnut)	
Temperature		Is the coffee temperature within spec	
Grinder		Is the grinder noise normal	
Steam			
Steam		Does the steam work	
Hot Water		Does the hot water work	
Milk		(if applicable)	
Cappuchino		Does the cappuccinatore produce good froth	

Leakage		
Leakage	14	Did the product leak during the testing
	15	Draining the circuit (in winter)
Cleaning		
	16	Clean water reservoir, bean reservoir, brew chamber and conveyor
		Clean and dry brew unit, coffee bin and drip tray.
		Lubricating the brewing unit with suitable grease
		External cleaning
Safety check		
		Earth leakage, Isolation test, resistor of earth wire grounding, as requested in certain country's (VDE, ISO)
visueel		Check the mains cord for damages
Packing		
	18	Packing
		Check completeness (accessories) according income log
	19	Neatly pack the product
Documentation		
		NFF letter
		Descaling instruction with changed procedure (S/C)
		Other instructions according S/C
Repair report		
		Is there an answer to ALL consumer questions/complaints (see complaint)
		add set statistic and give, if needed clear instruction towards consumer
		Is it indicated which documents are added
		Are there tips how to prevent issues

CHAPTER 7

DISASSEMBLY

7.1. Outer Shell in Gran Baristo and GranBaristo V2

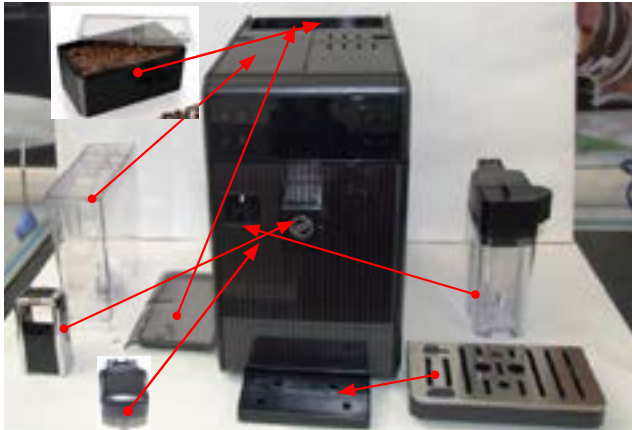

Remove the water tank, coffee container and cover, drip tray, dreg drawer, brewing unit, hot water dispenser, Milk carafe.

Lateral panels



Unscrew the screws shown.

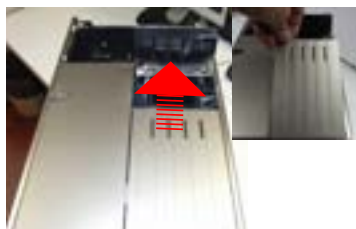

Remove the cover.



Unscrew the screw shown.



Remove the left, right and posterior panels

Top cover



CAUTION: Every time that it's necessary to access inside the machine, after removing of the two lateral panel, the capacitive keyboard must be fixed on the appliance side with paper adhesive tape, as shown in the image.



This action serves to avoid damaging the electrical connections.



Take care to not cover keyboard buttons with the tape.



Unscrew the screw shown.

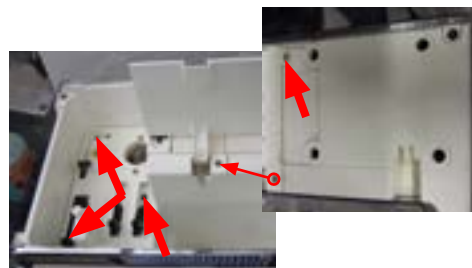

Unscrew the screws shown.



Remove the cover.



Remove the reed sensor.



Disconnect all electrical and water circuit connections and remove the top cover.

Lateral panels Gran Baristo V2



Remove the water container door

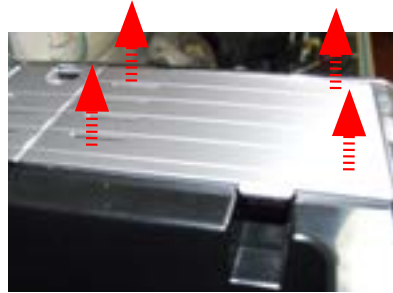

Remove the cup warning lid making sure to rise it near the hooks highlighted



Unscrew the screws shown and remove the lateral panels



Top cover



Remove the rubber plugs and unscrew the screws shown



Press the parts highlighted and lift the top cover

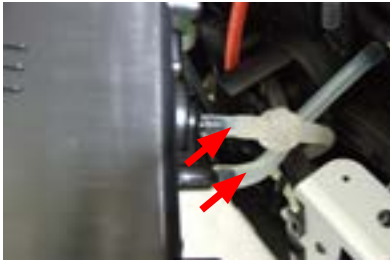

Disconnect the hydraulic and electrical connections highlighted

7.2. Service door



Unscrew the screws shown.



Remove the highlighted frame.



Lift the pin with a screwdriver and remove it through the top of the door.



Graft milk carafe and hot water



Unscrew the screws indicated and remove the cover.



Unscrew the screws indicated.



In the reassembling make sure the spring is repositioned correctly (see photo).

Dispenser assembly



Unscrew the screws indicated.



To remove the cover slide downwards and after to the right to release the anchors "see images".





Remove the dispenser, remove the insert and unhook the anchors.

7.3. Coffee grinder



Remove the cover.

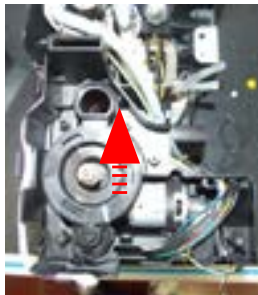

Raise the coffee grinder and remove the connections.



When reassembling the coffee grinder, make sure the spring is repositioned correctly (see photo).

7.4. Grinder blades

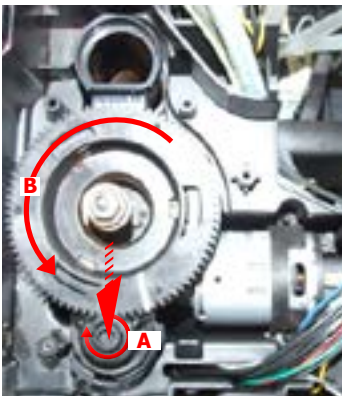

To extract the top support of the appliance, press on the grinding adjustment spindle (A) and turn the support anticlockwise until it unhooks.



Turn the grinder blades anticlockwise out of the support.



Turn the grinder blades clockwise out of the support. The bayonet connections can be accessed from the rear.

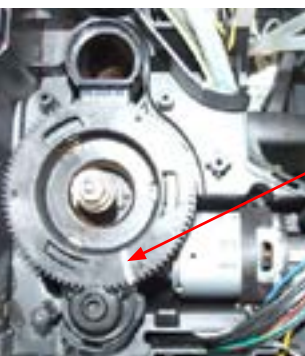

For a standard adjustment, both markings must be aligned.

7.5. Coffee grinder adjustment

Removable coffee bean hopper (depending on the model)

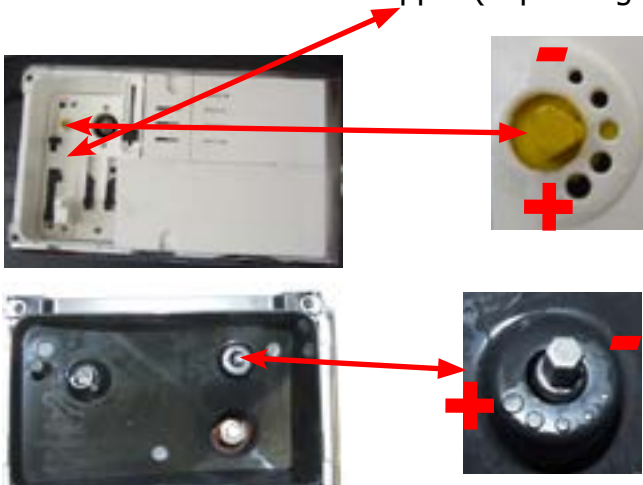

The grinding adjustment can be set by the user (only with the coffee grinder in operation) by pressing and turning (only by one click at a time) the insert inside the coffee bean hopper with the aid of the wrench supplied.

Adjustment by a service center

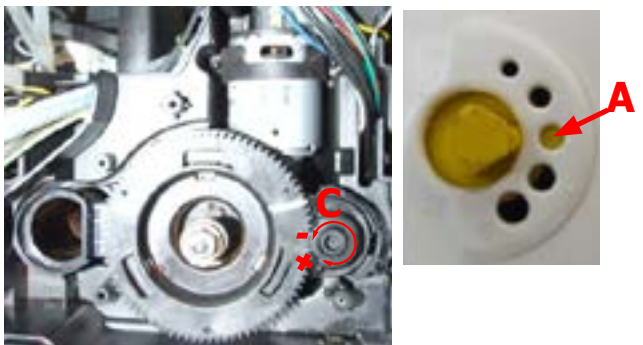

To adjust grinding further, the technical service can work directly on the coffee grinder by pressing and turning the ring nut (C) shown. (clockwise + to increase the particle size of the coffee and anticlockwise - to decrease it).

If there are any remains of coffee powder between the two grinding blades it is recommended to tighten by max. two marks at a time.

Lastly, move the point yellow (A) on the adjustment knob to the center of the adjustment .

7.6. Solenoid valve and assembly drain valve



Loosen the screws holding the solenoid valve to the upper plate



Loosen the screws holding in the support the solenoid valve.



Disconnect all electrical and water circuit connections.



Slide out the fork as illustrated and disconnect the electrical / idraulics connections.

7.7. The piston assembly.



Piston assembly



Loosen the screws highlighted and disconnect the silicone tube.



Remove the assembly and disconnect the electrical / idraulics connections.

7.8. Pin boiler



Loosen the screws highlighted and slide out the fork as illustrated.

7.9. Thermostats

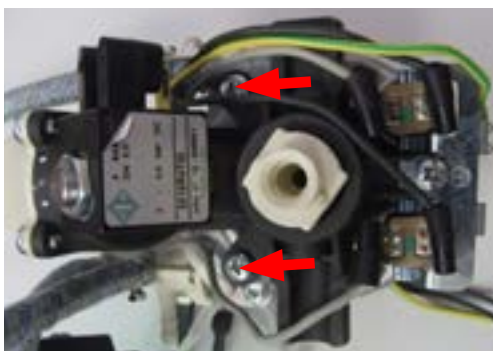

CAUTION: Do not unscrew the screws highlighted for no reason.



Loosen the screws highlighted and remove the thermostats unplugging from the electrical connections.

7.10. Pump

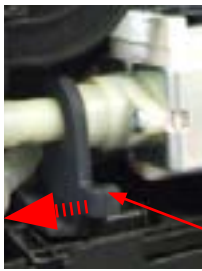

Slip off the pump off the support.

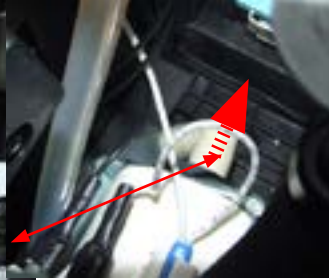
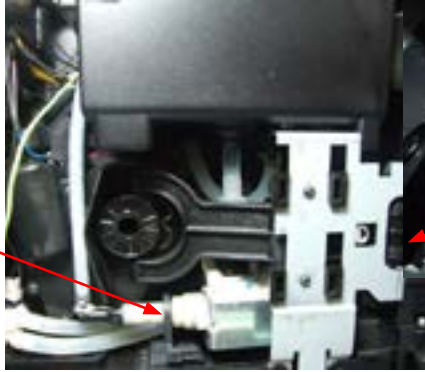

Remove the pump extension.



Disconnect the electrical / idraulics connections.

7.11. Flow-meter



Lift the flow meter out of the casing assembly and remove the electrical and water circuit connections.

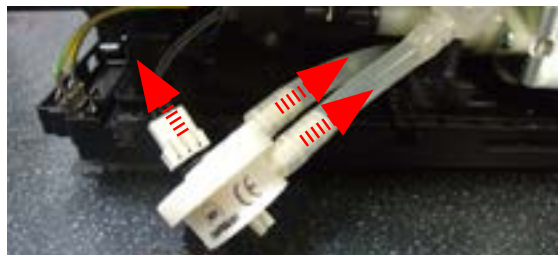

7.12. Gearmotor and microswitch present brew unit.

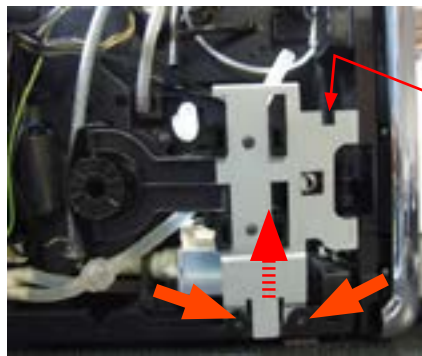

Loosen the screws, unlock the pin and remove the system of levers.



In the reassembling make sure the spring is repositioned correctly (see photo).

Microswitch present brew unit.

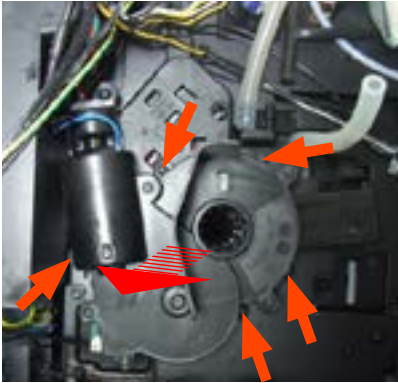

Loosen the screws highlighted and remove the gearmotor assembly.



Lift the assembly and in the back there is the microswitch.



Loosen the screws highlighted and remove the gearmotor cover.

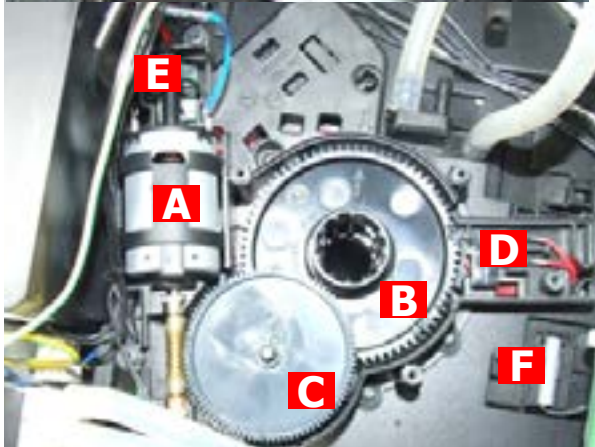

- The following are located inside the compartment protected by the casing:
- Electric motor (A) with gears (B) and (C) for transmission and timing of the dispenser.
 - Microswitch (D) detecting brewing unit home and work positions.
 - Remove the gear (C) that meshes with the motor transmission shaft.
 - Remove the large gear (B).
 - Remove the motor (A), complete with transmission shaft.
 - Gear box encoder board (E)
 - Drip tray sensor reed (F)

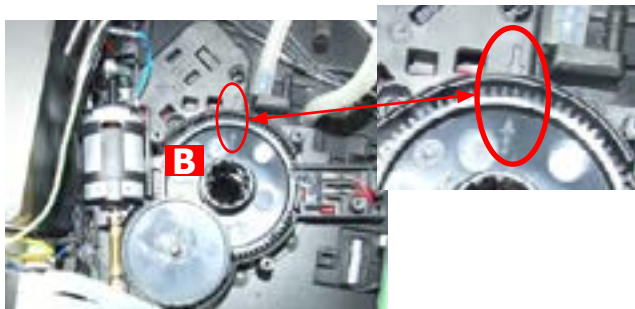

Replace the gear (B), making sure that the imprint of the arrows are aligned.



When replacing the motor and the transmission shaft, make sure the guide runners (L) are in the right position.
Grease the shaft thoroughly and evenly.

7.13. CPU board and KYB interface and display

Lateral panels

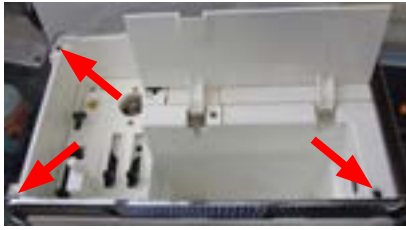

Unscrew the screws shown.



Remove the cover.



Unscrew the screw shown.

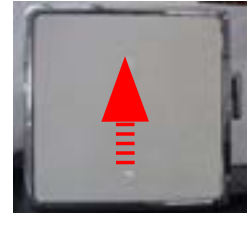

Remove the left, right and posterior panels

Top cover



Unscrew the screw shown.



Unscrew the screws shown.

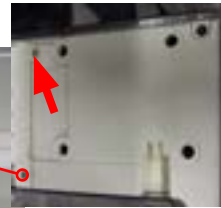

Remove the cover.

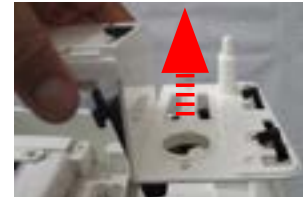

Remove the reed sensor.



Disconnect all electrical and water circuit connections and remove the top cover.



CPU board



Remove the cover.

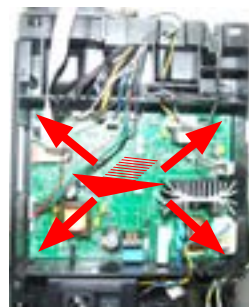

Unscrew the screws and extract the card off the support and disconnect the electrical connections.

KYB interface and display



Remove the KYB interface and display.



Remove the electrical connections.



Disconnect the electrical connections.

7.14. Bluetooth board in Granbaristo Avanti



Unscrew the screw shown and remove the cover.

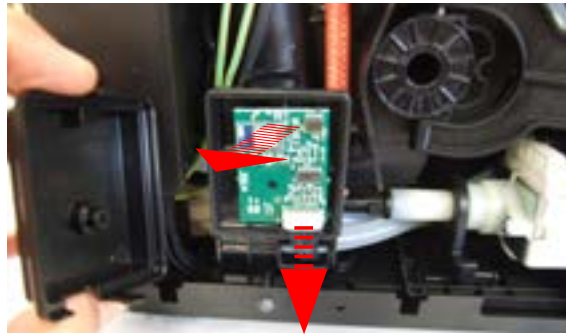

Disconnect the electrical connections and remove the bluetooth board.

7.15. Fitting and removing Oetiker clamps

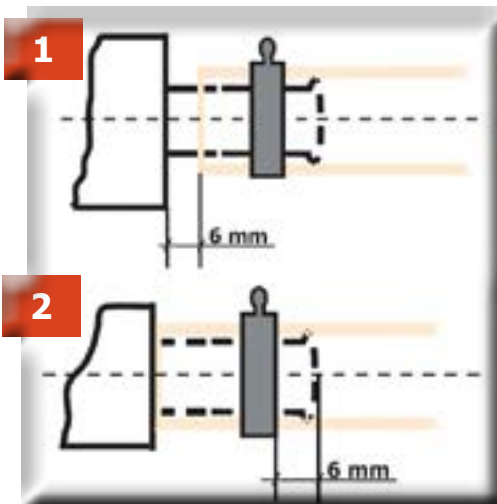

1) Boiler connection.

2) Other connections.



Use a suitable pair of pliers to remove the clamp (as illustrated).



Tighten the clamp as illustrated.

CHAPTER 8

NOTES

CHAPTER 9

WATER CIRCUIT DIAGRAM

Gran Baristo

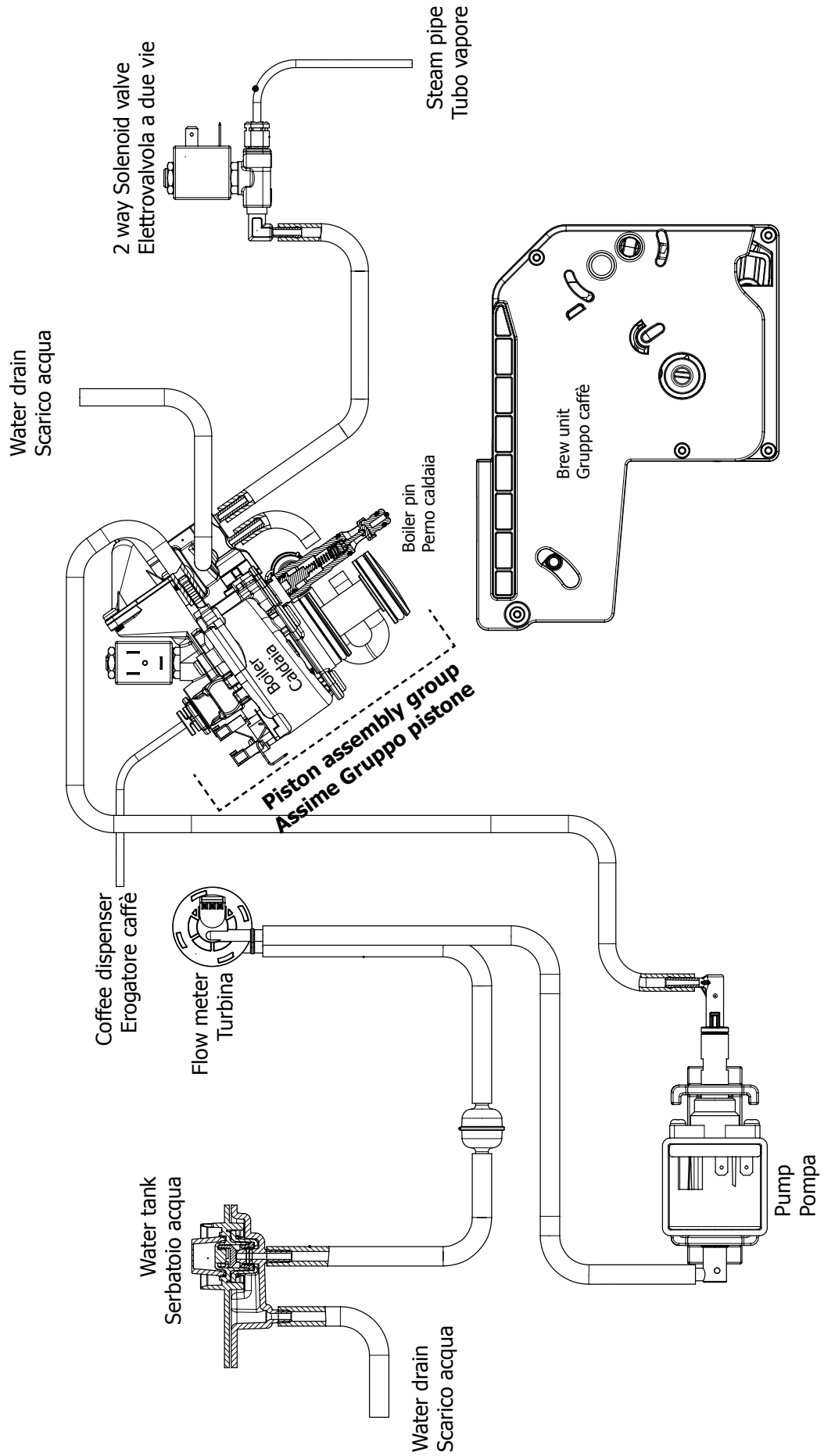

CHAPTER 10

ELECTRICAL DIAGRAM

Gran Baristo Avanti

