

Service
Service
Service



Philips Consumer Lifestyle

Service Manual

PRODUCT INFORMATION

Features

- Extra Large feeding tube The XL feeding tube takes whole fruits and vegetables so you don't need to pre-cut them anymore.
- Large 3.4L bowl The large 3.4 L bowl allows for maximum volumes to be processed in 1 go: capacity for 2 L soup, 1.7 kg dough, 7 egg whites.
- 31 functions 7 tools for 31 different functions. They are: a SS blade for chopping, crumbling, cutting, mashing, mincing; an adjustable slicing disk for 1-7 mm slices; a shredding disk for medium or fine shredding or grating; a balloon beater for whipping, whisking, emulsifying, stirring, mixing, creaming, beating; a kneading tool for heavy mixing, kneading, folding in; a blender for blending, crushing, foaming, grinding, (heavy)pureeing, homogenizing, liquidizing, milling, shaking, stirring, measuring; a citrus press for pressing citrus fruits.
- 1000 W motor + Variospeed With the powerful 1000 W motor plus variable speed button you can adjust speed precisely to get desired results.
- Adjustable slicing blade With the adjustable slicing blade, you can make slices as thin as 1 mm and up to 7 mm thick.
- Sturdy base The sturdy base comes with suction feet to ensure it does not move, even when you use it for heavy applications like kneading dough.

Accessories

- Citrus press For pressing of citrus fruits
- Kneading tool For kneading, heavy kneading, mixing dough, batter
- Stainless steel chopping knife Chopping, beating, creaming, crumbling, cutting, folding in, mashing, mincing
- Balloon beater For whipping, whisking, mixing and emulsifying
- Reversible shredding disk For medium and fine shredding
- Adjustable slicing disk For 1-7 mm slices of fruit & vegetables
- Break resistant blender For blending, crushing, foaming, grinding, pureeing, homogenizing, liquidizing, milling, shaking, stirring

Safety

- Automatic resettable thermal cut off Protecting the motor against overheating.
- Built-in safety lock Detects whether lid & bowl are assembled.
- Brake system Stops the accessories within 1,5 seconds.

SPECIFICATIONS

General specifications

Integrated cord storage, Non-slip feet

Technical Specifications

- Cord length 1,20 m
- Voltage 220 - 240 V
- Frequency 50 - 60 Hz
- Bowl volume capacity dry 3,4 l
- Bowl working capacity liquid 2 l
- Bowl working capacity dough 1700 g
- Bowl working capacity flour 1000 g
- Blender working capacity 1,5 l
- Safety Lid & bowl detection, mechanical 1,5 sec brake
- Speeds Variospeed
- Function buttons Pulse, Ice
- Motor unit length = 220 mm, width = 260 mm, height = 160 mm
- Height motor unit + attached Bowl / Jar 400 mm.
- Weight 4,3 kg (incl. Accessories)

Design specifications

- Housing ABS
- Knife holder, balloon beater POM
- Disks, chopping blade Stainless steel
- Speed knob Brushed aluminium
- Kneading tool, citrus press PP
- Colours Bright white, dark grey sides, deep red accents
- Bowl + lid, blender SAN
- Pusher ABS
- Inner pusher SAN

DISASSEMBLY- AND RE-ASSEMBLY ADVISE

- No specific issues.

REPAIR INSTRUCTION

- No specific issues.

Pos	Service code	Description	
1	4203 035 82990	Housing	
2	4203 035 82730	Bottom	
3	4203 035 82770	Sucker Foot (1 pc)	
4	4203 035 88740	Motor inc. wires + gearing	
5	4203 035 82750	Switch knobs	
6	4203 035 82700	PCBA	Old
	4203 035 91190	PCBA	New
7	4203 035 83010	Holder safety switch + lever	
8	4203 035 82760	Safety switch	Old
	4203 035 91200	Safety switch	New
9	4203 035 82960	Cordset - EU	
	4203 035 82970	Cordset - UK	
	4203 035 82980	Cordset - Swiss	
10	4203 035 82900	Pusher	
11	4203 035 82600	Inner Pusher	
12	4203 035 82890	Bowl Lid	
13	4203 035 82880	Bowl	
14	4203 035 82660	Safety Lever Bowl	
15	4203 035 82850	Toolholder	
16	4203 035 82790	Adjustable Slicing Disc	
17	4203 035 82780	Shredding Disc	
18	4203 035 82870	Chopping Knife incl. protection	
19	4203 035 82860	Kneading Tool	
20	4203 035 82800	Gear unit - Whisk Accessory	
21	4203 035 82810	Whisk basket	
22	4203 035 82830	Press Cone	
23	4203 035 82820	Citrus Press Sieve	
24	4203 035 82610	Measuring Cup	
25	4203 035 82930	Jar Lid	
26	4203 035 82940	Blender Jar	
27	4203 035 82650	Sealing Ring	
28	4203 035 82950	Knife Unit	
29	4203 035 82840	Spatula	
30	4203 035 89140	Driving coupling assy	
31	4203 035 89630	Twin Beater Assy white	
32	4203 035 89640	Whisk basket white (1 pcs.)	

ATTENTION:

Please use Pos. 6 old, 8 old, 20 and 21 till production date 0915.

Please use Pos. 6 new, 8 new, 31 and 32 from production date 0916 onwards.

 New PCB and new safety switch are only used in version with Twin Beater Assy (Pos. 31).

EXPLODED VIEW

HR7774/30

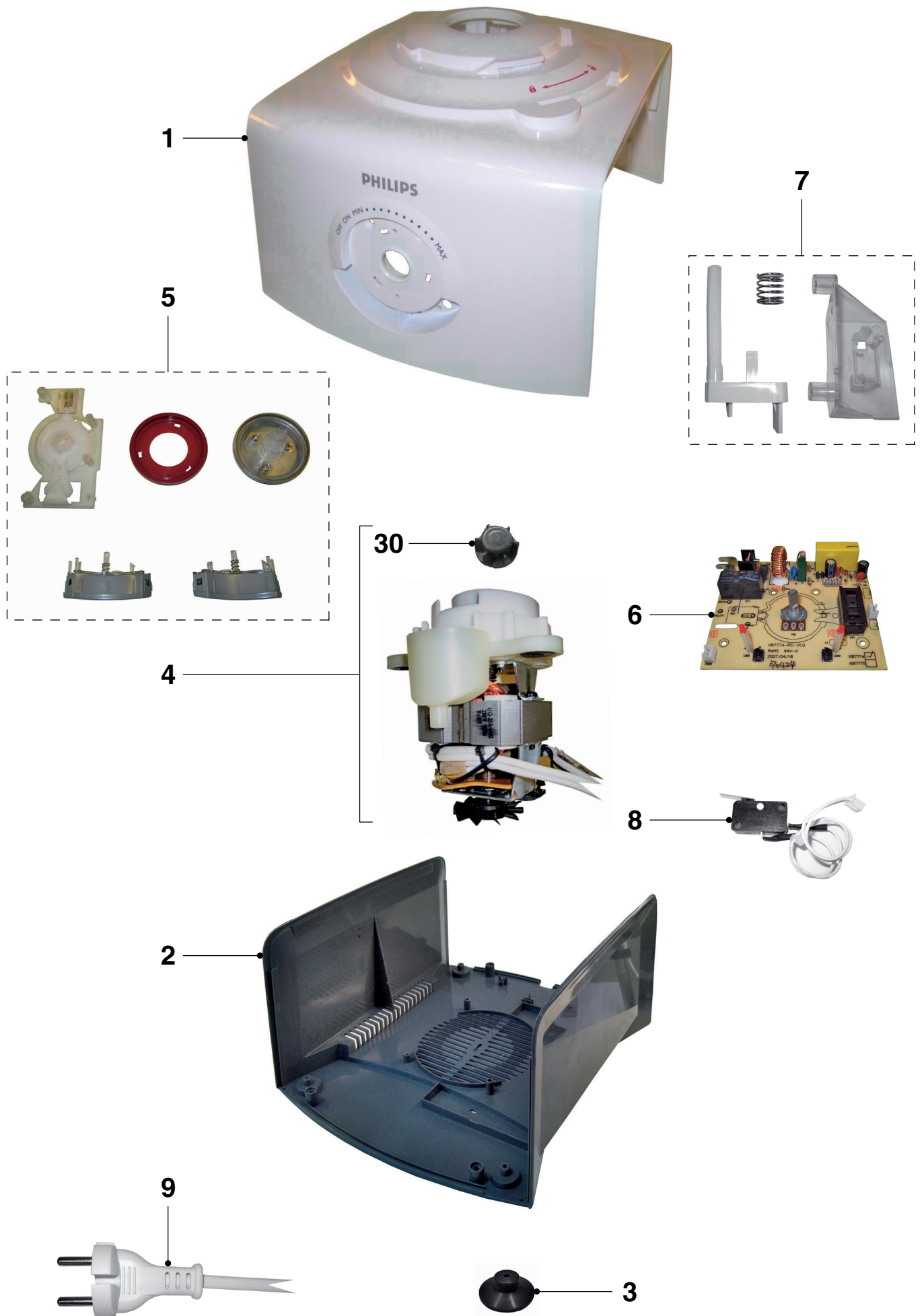

EXPLODED VIEW

HR7774/30

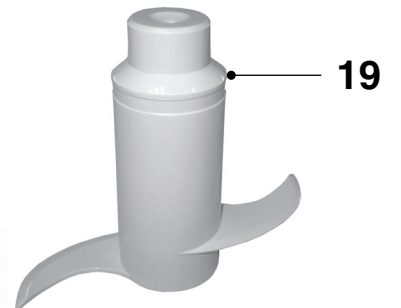
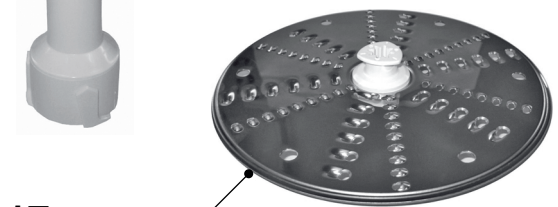
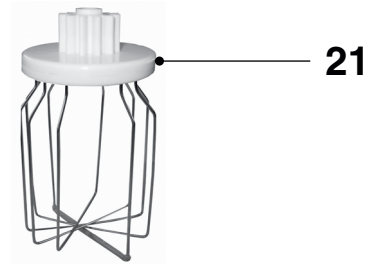
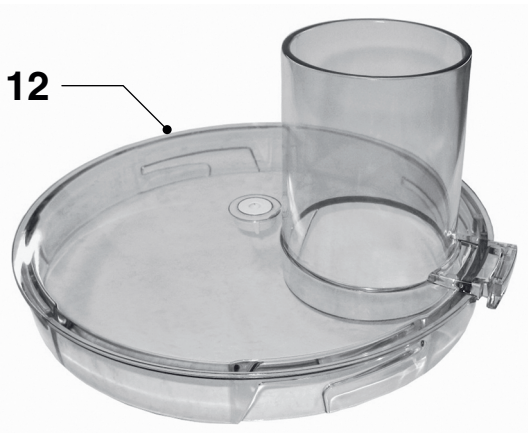
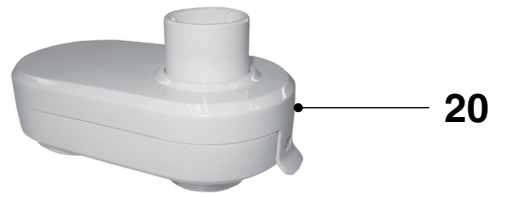
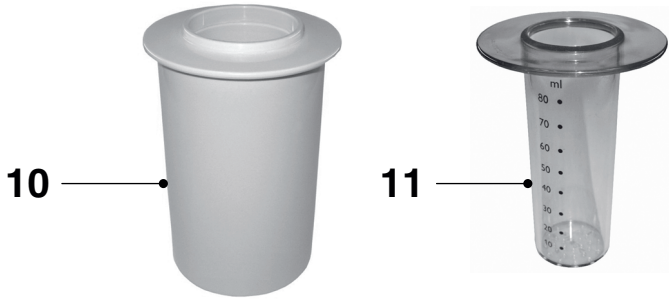

EXPLODED VIEW

HR7774/30

