

GAGGIA®

GAGGIA

GAGGIA

Accademia

GAGGIA

Service Manual

Revision 00 March 2010

GAGGIA

GAGGIA

GAGGIA

GAGGIA



All parts of this document are the property of Saeco International Group.
All rights reserved. This document and all the information herein is provided without liability deriving from any errors or omissions. Furthermore, no part may be reproduced, used or collected, except where specific authorisation has been provided in writing or through a contractual agreement.

Rev. 00 / March 2010

Contents

| | Page |
|--|-------------|
| 1. Introduction | |
| 1.1 Documentation required | 1 |
| 1.2 Tools and equipment required | 1 |
| 1.3 Material | 1 |
| 1.4 Safety warnings | 1 |
| 1.5 Accademia Range | 2 |
| 1.6.1 External machine parts | 3 |
| 1.6.2 Internal machine parts | 4 |
| | |
| 2. Technical specifications | |
| 2.1 Technical specifications | 1 |
| 2.2 Machine parameters and performance | 2 |
| | |
| 3. User instructions | |
| 3.1 Customer and programming menu | 1 |
| 3.2 Machine indications | 2 |
| 3.3 Operation, cleaning and maintenance | 3 |
| | |
| 4. Operating logic | |
| 4.1. Water circuit | 1 |
| 4.2 Frother valve assembly | 2 |
| 4.2.1 General carafe assembly | 2 |
| 4.3 Multi-way valve | 4 |
| 4.4 Coffee cycle | 5 |
| 4.5 Single microswitch | 6 |
| 4.6 Temperature sensor (adjustment) | 6 |
| 4.7 Coffee grinder | 7 |
| 4.8 Detection of coffee bean absence, dose adjustment, blocked coffee grinder | 7 |
| 4.9 Auto-learning dose (SAS) | 8 |
| 4.10 SBS | 9 |
| 4.11 Water level detection in the tank | 10 |
| 4.12 Water level detection in the drip tray | 10 |
| 4.13 Descaling request | 11 |
| 4.14 Anti-scale filter | 11 |

Contents

| | Page |
|---|-------------|
| 5. Troubleshooting | |
| 5.1. Test mode | 1 |
| 5.2. Diagnosis mode | 6 |
| 5.3. Error messages | 12 |
| | |
| 6. Standard inspections | |
| 6.1. Repair schedule | 1 |
| 6.2. Service schedule | 1 |
| 6.3. Final inspection | 2 |
| | |
| 7. Disassembly | |
| 7.1. Outer elements | 1 |
| 7.2. Coffee grinder | 2 |
| 7.3. Grinder blades | 3 |
| 7.4. Coffee grinder adjustment | 4 |
| 7.5. Steam pump | 5 |
| 7.6. Coffee pump | 5 |
| 7.7. Flow meter | 5 |
| 7.8. Power board | 6 |
| 7.9. Steam boiler | 6 |
| 7.10. Coffee boiler | 6 |
| 7.11. Gearmotor | 7 |
| 7.12. Frother valve assembly | 8 |
| 7.13. Dispenser assembly | 8 |
| 7.14. Steam pipe assembly | 9 |
| 7.15. Teflon pipe support and carafe fitting assembly | 9 |
| 7.16. Carafe board general assembly | 10 |
| 7.17. CPU board, display and front panel | 10 |
| 7.18. Oetiker clamps | 12 |
| | |
| 8. Notes | |
| | |
| 9. Water circuit diagram | |
| | |
| 10. Electrical diagram | |

CHAPTER 1

INTRODUCTION

1.1 Documentation required

The following documentation is required for repairs:

- Instruction booklet of the specific model
- Technical documentation of the specific model (diagrams, exploded drawings)

1.2 Tools and equipment required

Besides standard equipment, the following tools are required:

| Qty. | Description | Notes |
|------|----------------------------|--|
| 1 | Screwdriver | Torx T 8 - T 10 - T 20 |
| 1 | Pliers for Oetiker clamps | |
| 1 | AC - DC - Vdc tester | |
| 1 | Digital thermometer | Scale limit > 150°C |
| 1 | SSC (Saeco Service Center) | Programmer (for programming and diagnosis mode) |

1.3 Material

| Description | Notes |
|-----------------|-------------------------|
| Thermal paste | Heat resistance > 200°C |
| Descaler | Saeco descaler |
| Degreaser | Personal choice |
| Silicone grease | Safe to use with food |

1.4 Safety warnings

It is recommended to consult the technical manual of the machine before implementing any operation.

Comply with all applicable standards relating to the repair of household appliances.

Always disconnect the power plug from the mains before beginning repairs on the machine.

Simply turning off the main switch is not sufficiently safe to prevent electrical discharges.

This household appliance is rated as insulation class I.

On completion of the repairs, insulation and dielectric rigidity tests must be performed.

1.5. Accademia Range



| | Accademia |
|--|------------------|
| Display interface | X |
| With painted stainless steel parts | X |
| Milk carafe | X |
| Clean (automatic milk circuit washing) | X |
| Automatic dosing (SAS) | X |
| Cup heater | X |
| Quantity of dispensed coffee saved in memory | X |
| Quantity of dispensed milk saved in memory | X |
| Automatic shutdown (after 60' inactivity) | X |
| SBS | X |
| Compartment for ground coffee | X |
| Automatic descaling cycle | X |

1.6.1 External machine parts

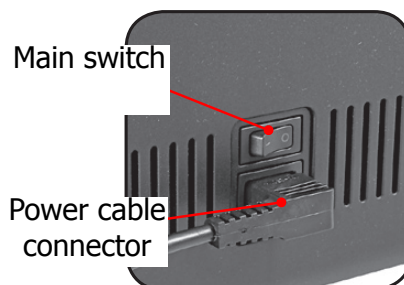
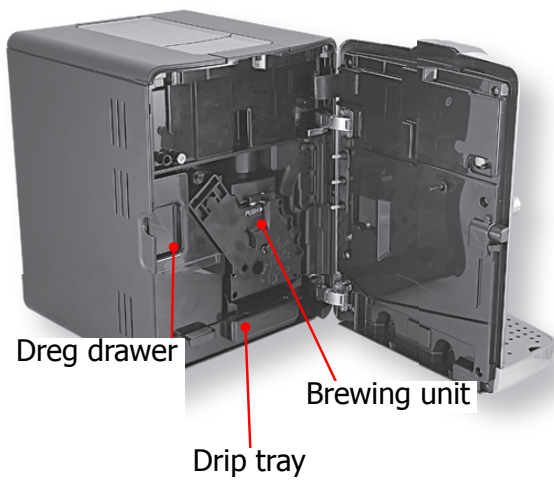

1.6.2 Internal machine parts

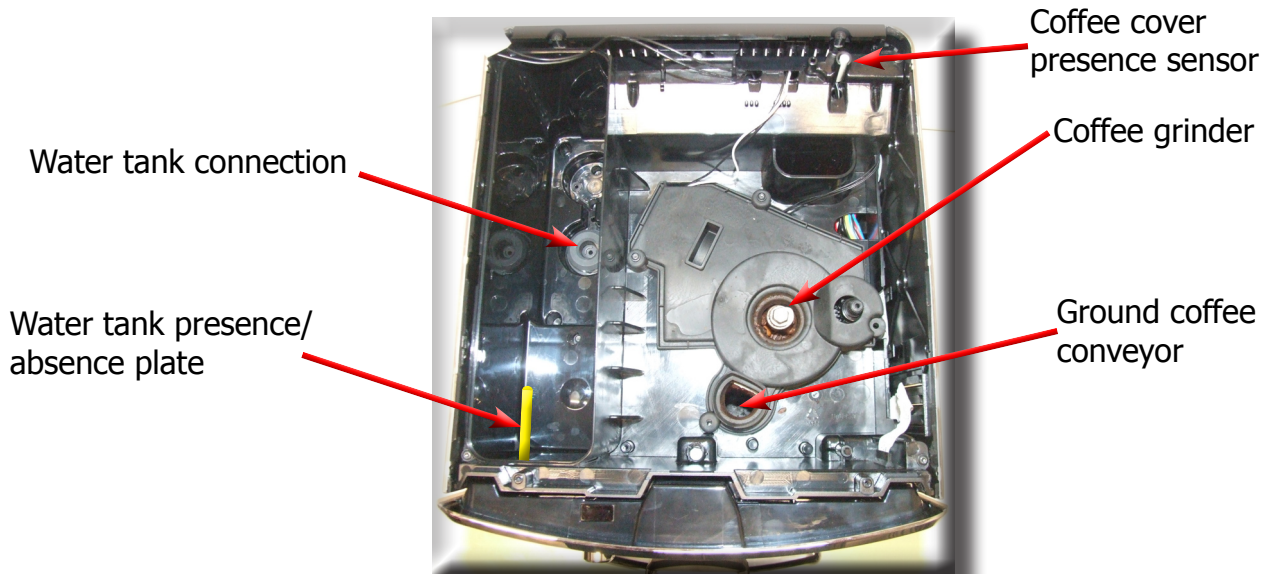
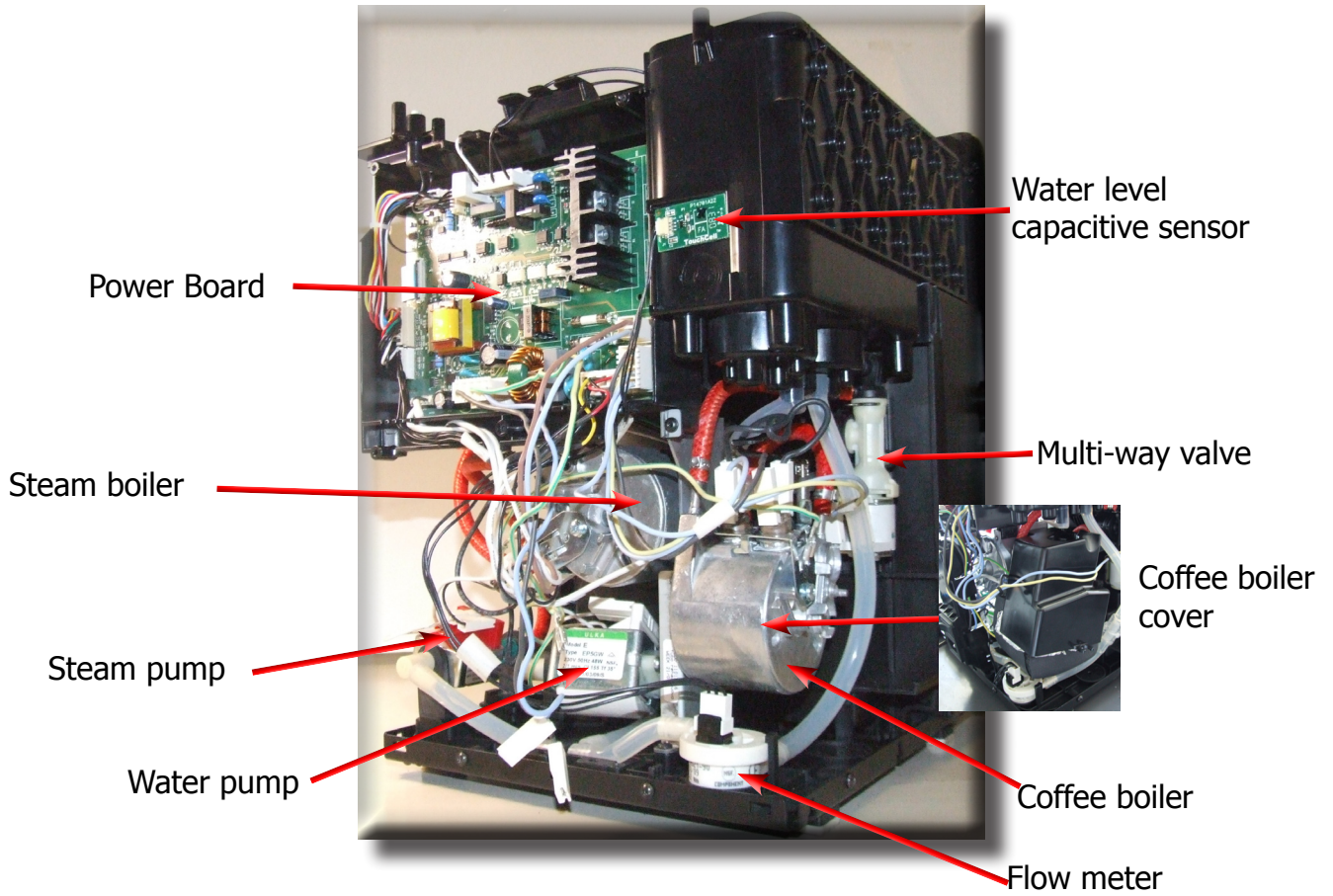

CHAPTER 2

TECHNICAL SPECIFICATIONS

2.1. Technical specifications

| | |
|--|--|
| Power supply and output: | 240 V~ 50 Hz 1400 W - 230 V~ 50/60 Hz 1400 W - 120 V~ 60 Hz 1500 W - 100 V~ 50/60 Hz 1300 W |
| Temperature monitoring: | Variable resistor sensors (NTC) transmits the value to the control board |
| Safety system: | 2 manual reset or one-shot thermostats (175°C) |
| Coffee heat exchanger output: Stainless steel | (230/120 V~) 1300 W – (100 V~) 1100 W to dispense coffee, hot water and steam |
| Steam heat exchanger output: Stainless steel | As above |
| Gearmotor: | 2 rotation directions; 24VC power supply |
| Coffee pump | Ulka Type EP5/S GW approx. 13-15 bar with reciprocating piston and 120°C cutout 48 W, 230V, 50 Hz, 120V, 60Hz 100V, 50/60 Hz |
| Steam pump | Ulka MF with reciprocating piston 230V, 50 Hz, 120V, 60Hz 100V 50/60 Hz |
| Overpressure valve: (multi-way valve) | Opening at approx. 17-23 bar |
| Water filter: | In tank |
| Coffee grinder: | Direct current motor with flat ceramic grinder blades |
| Automatic dosage | Dose adjustment controlled by the electronic system |
| Consumption: | During the heating phase - approx. 5.6 A |
| Consumption in Stand-by | < 1 W |
| Dimensions: W x H x D in mm: | 290x375x444 |
| Weight: | 16 kg |
| Water tank capacity: | 1.7 l. |
| Coffee container capacity | 250 g coffee beans |
| Dreg drawer capacity | 15 |
| Heat exchanger capacity: | Approx. 10 cc |
| Water circuit filling time: | Approx. 15 sec. max on first filling cycle |
| Heating time: | Approx. 45 sec. |
| Dispensing temperature: | Approx. 84°± 4° |
| Grinding time: | Approx. 8-10 sec. |

2.2. Machine parameters and performance

| PRODUCT QUANTITY | Min quantity (Puls.) | Max quantity (Puls.) | Max quantity (Puls.) | Set by the user | Set by the Production/Service Dept |
|------------------|--|----------------------|----------------------|-----------------|------------------------------------|
| Espresso | 50 | 130 - 170 * | 600 | Yes | No |
| Espresso lungo | 70 | 200 - 230 * | 600 | Yes | No |
| Pre-ground | Yes | | | | |
| Hot water | Continues for 400 pulses | | | | |
| Steam nozzle | Continues until the water is used up (capacitive sensor) | | | | |

* Depends on the language selected by the user

| RINSE | Initial rinse | Final rinse |
|---|---|---|
| When performed | When the machine is switched on and the temperature of the boiler reaches $\leq 50^{\circ}\text{C}$ | When the machine is switched off electronically, manually or automatically after 60', if at least one coffee has been dispensed before being switched off |
| No. of Pulses | 130 | 100 |
| Stop option | Yes, by pressing any key | Yes, by pressing any key |
| Can be disabled by the user | Yes | No |
| Can be disabled by the Production/Service Dept | No | No |
| No. of pulses adjustable by the user | No | No |
| No. of pulses adjustable by the Production/Service Dept | No | No |
| Pulse range (Min - Max) | No | No |

| Descaling frequency | | | |
|---------------------|--|-----------------------------|-----------------------------|
| Hardness | Water hardness | Without anti-scale filter | With anti-scale filter |
| 1 | Soft (up to 7°dH) | 240 litres (480,000 pulses) | 480 litres (960,000 pulses) |
| 2 | Medium ($7^{\circ} - 14^{\circ}\text{dH}$) | 120 litres (240,000 pulses) | 240 litres (480,000 pulses) |
| 3 | Hard ($15^{\circ} - 21^{\circ}\text{dH}$) | 60 litres (120,000 pulses) | 120 litres (240,000 pulses) |
| 4 | Very hard (over 21°dH) | 30 litres (60,000 pulses) | 60 litres (120,000 pulses) |

The default water hardness level is 3. Each litre of water corresponds to approximately 2,000 pulses

| ACCADEMIA | 02 TECHNICAL SPECIFICATIONS |
|--|--|
| DREG DRAWER | Description and values |
| Time-out for dreg drawer | 5 sec. |
| Warning to empty dreg drawer | Yes, after 12 lots of dregs |
| Empty dreg drawer block alarm (double espresso as the last dispensed product) | 15 lots of dregs (16 lots of dregs) |
| Reset dreg counter | Only if the Warning or the empty dreg drawer alarm is triggered and the dreg drawer is removed for at least 5 seconds. |

| STAND-BY | Description and values |
|--|--------------------------|
| Input time (min - max) | 15 minutes - 180 minutes |
| Input time (default) | 60 minutes |
| Input time set by user | Yes |
| Input time set by the Production/Service Dept | Yes |
| Boiler temperature during Stand-by | Boiler OFF |
| Cup heater during stand-by | Cup heater OFF |
| Timer and Stand-by | Yes ** |

**** The machine switches on at the TimerOn (Timer) value and switches off when the "Stand-by input time" (Delay - Time) has elapsed**

| WATER TANK | Description |
|---|-------------|
| Water reserve (pulses) with water filter | 200 |
| Water reserve (pulses) with no water filter | 200 |
| Water reserve modifiable by the Production/Service Dept | No |
| "Fill tank" alarm | Yes |
| "No tray" alarm | No |
| Water mains | No |

CHAPTER 3

USER INSTRUCTIONS

3.1. Customer and programming menu

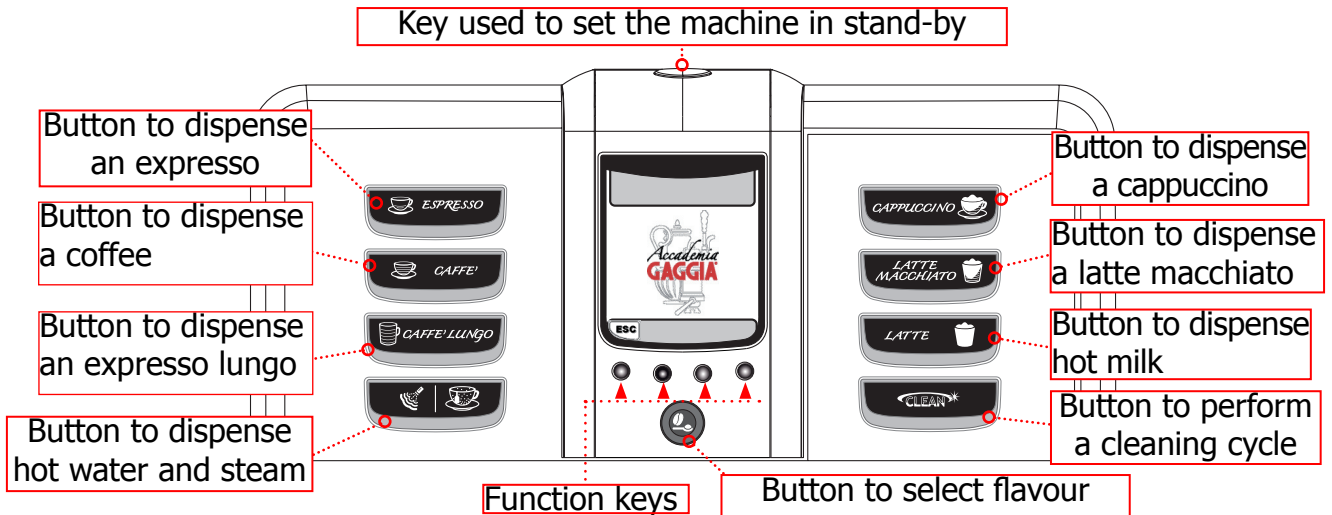

Espresso



- 1) Press the button pertaining to the desired product once for 1 product and twice for 2 products. To save the length, keep the button pressed for 3 sec.
- 2) Preparation begins by grinding the coffee
- 3) The coffee dispensing phase can be interrupted at any time by pressing "STOP".

Cappuccino/Latte macchiato/Milk



- 1) Place a container and turn the carafe handle clockwise
- 2) Press the button that corresponds with the desired beverage
- 3) Machine preparation begins
- 4) The machine can dispense an additional amount of milk if the highlighted button is pressed
- 5) The machine dispenses the coffee
- 6) Upon completion, bring the carafe handle back to the idle position, then the rinse cycle begins.

Dispensing hot water



- 1) Place a container beneath the hot water/steam dispensing pipe
- 2) Press button (1)
Press button (2) to dispense the set type
- 3) Remove the container at the end. Repeat the process to dispense another dose

Dispensing steam



- 1) Place a container beneath the hot water/ steam dispensing pipe
- 2) Press button (1)
Press button (2)
to start dispensing
- 3) Remove the container at the end.
Repeat the process to dispense another dose

3.2. Machine signals



Close the coffee bean container lid for any beverage to be dispensed

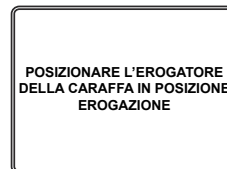

A beverage containing milk has been selected. Press the "ESC" key to cancel the selection.



Fill the coffee container with coffee beans

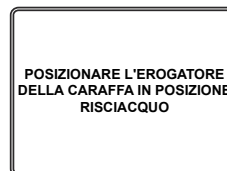

The carafe rinse function has been selected. Press the "ESC" key to cancel the selection.



Insert the coffee unit into its housing



An operation that requires a dispensing cycle of the milk container has been selected. Press the "ESC" key to cancel the selection.

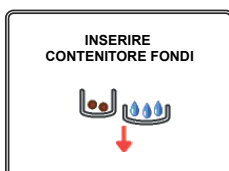

Insert the dreg drawer and the drip tray



The machine requires a descaling cycle. Damages caused due to the descaling cycle not being implemented non are not covered by the warranty.



Empty the drip tray that is beneath the coffee unit and the dreg drawer. **Only if the machine requires it and it is switched on.**



The machine requires the "Intenza" water filter to be replaced with a new one. Replace the filter.



The front door must be closed for the machine to be functional



Flashing red LED.
Machine in stand-by.

Press



Remove the tank and fill it with fresh drinking water



An error has occurred. Take note of the code (E xx). Switch off the machine and switch it back on after 30 seconds. If the problem persists, contact the assistance centre.

3.3. Operation, cleaning and maintenance

| Operating the machine | | |
|-----------------------|--------------------------------|---|
| 1 | Fill the water tank | |
| 2 | Fill the coffee bean container | |
| 3 | Switch on the appliance | |
| 4 | Press to switch on the machine |  |
| 5 | Select the desired language | Save |
| 6 | Heating | The heating phase begins, wait for it to finish |
| 7 | Rinse | Carries out a rinse cycle of the internal circuits |
| 8 | Machine ready | The machine is ready to dispense beverages |

| CLEANING AND TECHNICAL ASSISTANCE | | |
|-----------------------------------|---------------------------------|---|
| A | Empty the dreg drawer | If signalled |
| B | Empty the drip tray | As necessary (float) |
| C | Clean the water tank | Weekly |
| D | Clean the coffee bean container | As necessary |
| E | Clean the casing | As necessary |
| F | Clean the coffee unit | Every time the coffee bean container is filled or once a week |
| | Lubricate the coffee unit | After 500 dispensing cycles |
| | Clean the unit housing | Weekly |
| H | Descaling cycle | If signalled |

| Descaling frequency | | | |
|---------------------|------------------------|-----------------------------|-----------------------------|
| Hardness | Water hardness | Without anti-scale filter | With anti-scale filter |
| 1 | Soft (up to 7°dH) | 240 litres (480,000 pulses) | 480 litres (960,000 pulses) |
| 2 | Medium (7° - 14°dH) | 120 litres (240,000 pulses) | 240 litres (480,000 pulses) |
| 3 | Hard (15° - 21°dH) | 60 litres (120,000 pulses) | 120 litres (240,000 pulses) |
| 4 | Very hard (over 21°dH) | 30 litres (60,000 pulses) | 60 litres (120,000 pulses) |

The default water hardness level is 3. Each litre of water corresponds to approximately 2,000 pulses

CHAPTER 4

OPERATING LOGIC

4.1. Water circuit

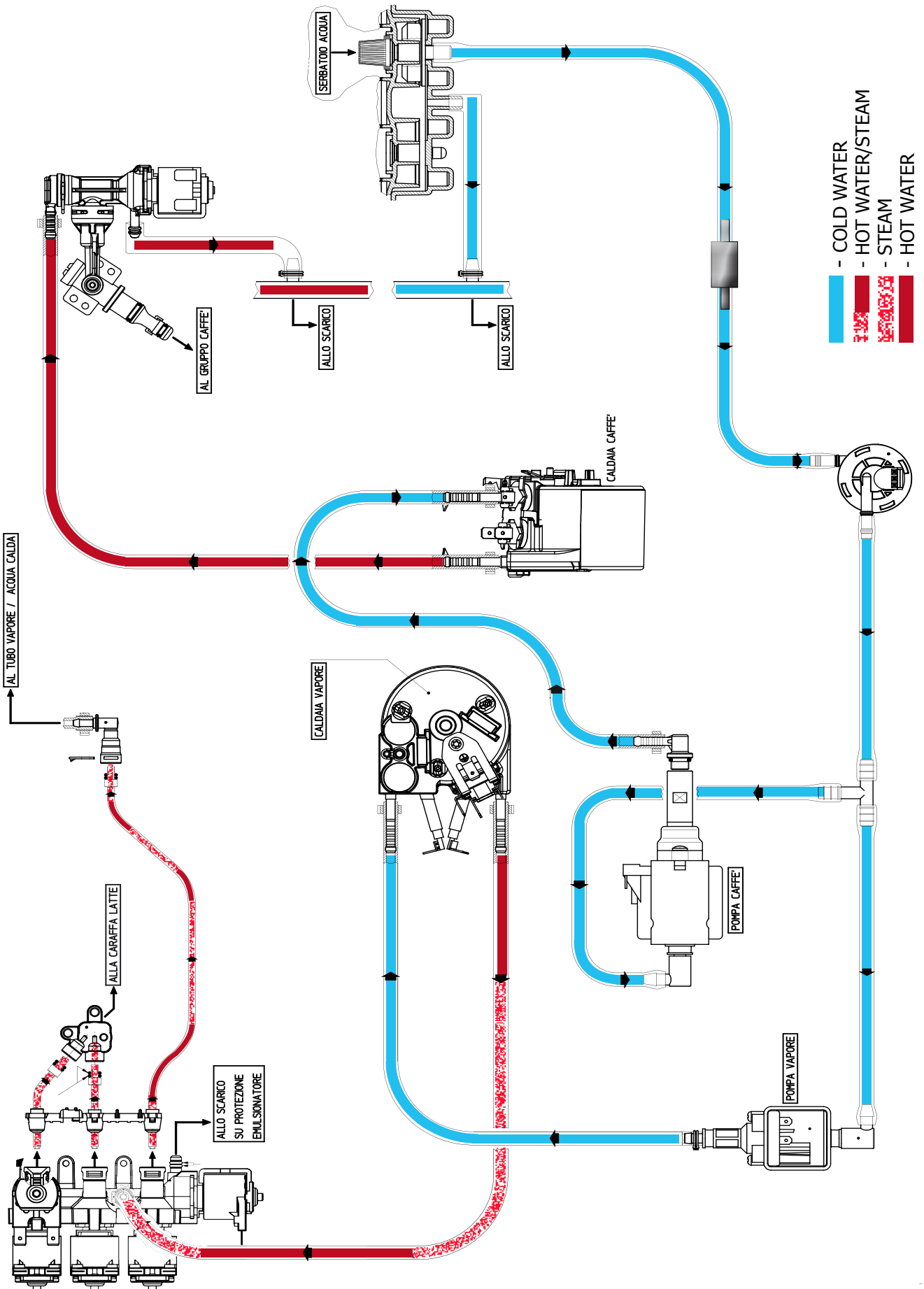

4.2. Frother valve assembly

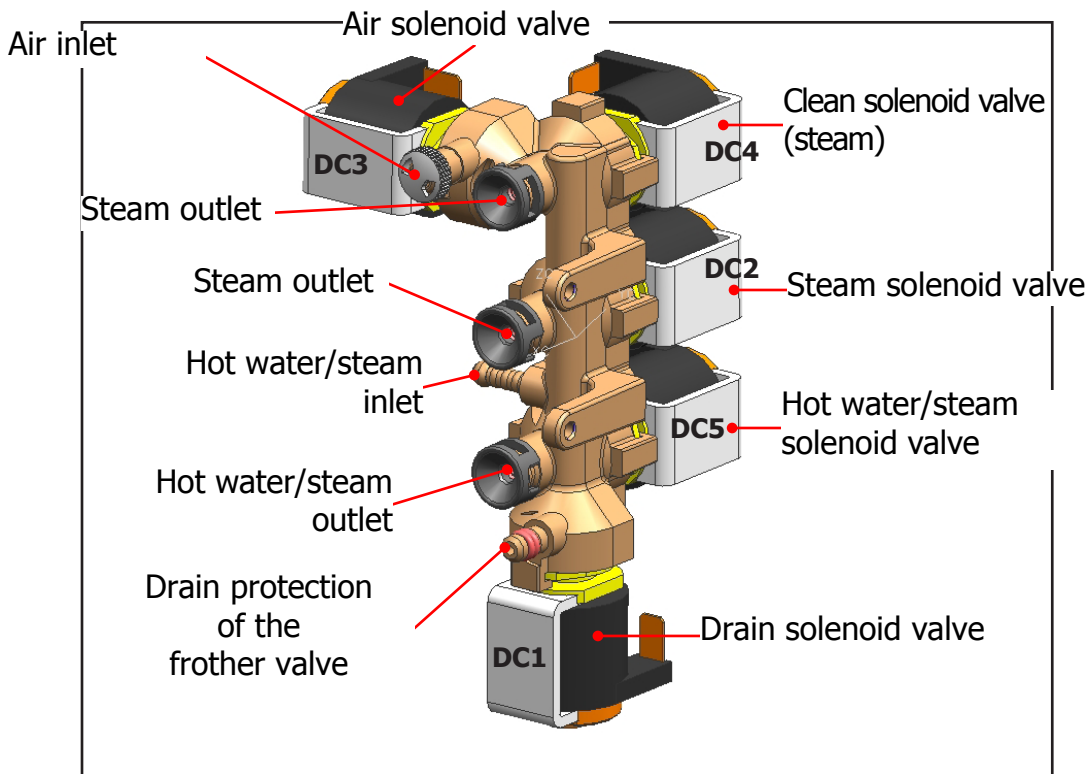

Specifications and requirements

Maximum operating pressure 3 bar

Maximum pressure in the water/steam circuit does not exceed 4.5 bar 0/+1

Hot water temperature 90°

Steam temperature 125°

4.2.1 General carafe assembly

| | |
|---|---|
| 1 | Cappuccino-maker body |
| 2 | Milk suction pipe and fitting |
| 3 | Venturi pipe |
| 4 | Milk dispenser pipe |
| 5 | Upper fitting of the carafe drain pipe carafe |
| 6 | Lower fitting of the carafe drain pipe |
| 7 | Levers, springs and cam for the signalling of carafe presence/absence and the position of the dispenser |

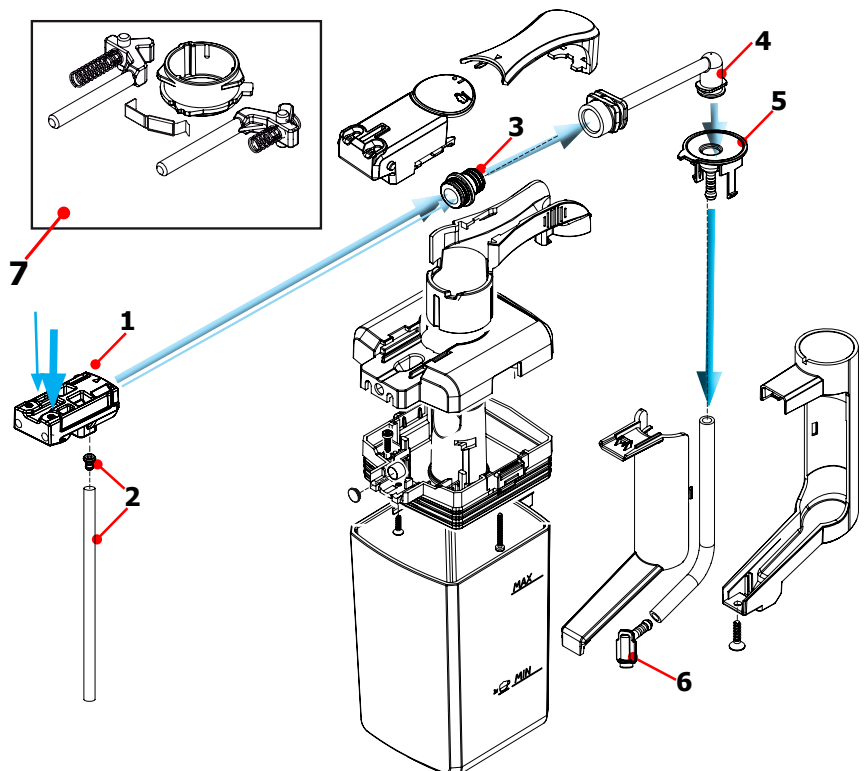

Functional mode for the production of milk products and cleaning the circuit

When the solenoid valves open and let air or hot water/steam through, the following situations occur:

- **DC3+DC2** STEAM + AIR = Frothing and heating of frothed milk
- **DC2** STEAM FROM CENTRAL HOLE = Heating of non-frothed milk
- **DC4** STEAM FROM LOWER HOLE = Cleaning of milk circuits

DC1 = safety valve
DC2 = steam valve
DC3 = air valve
DC4 = clean valve (steam)
DC5 = hot water/steam valve

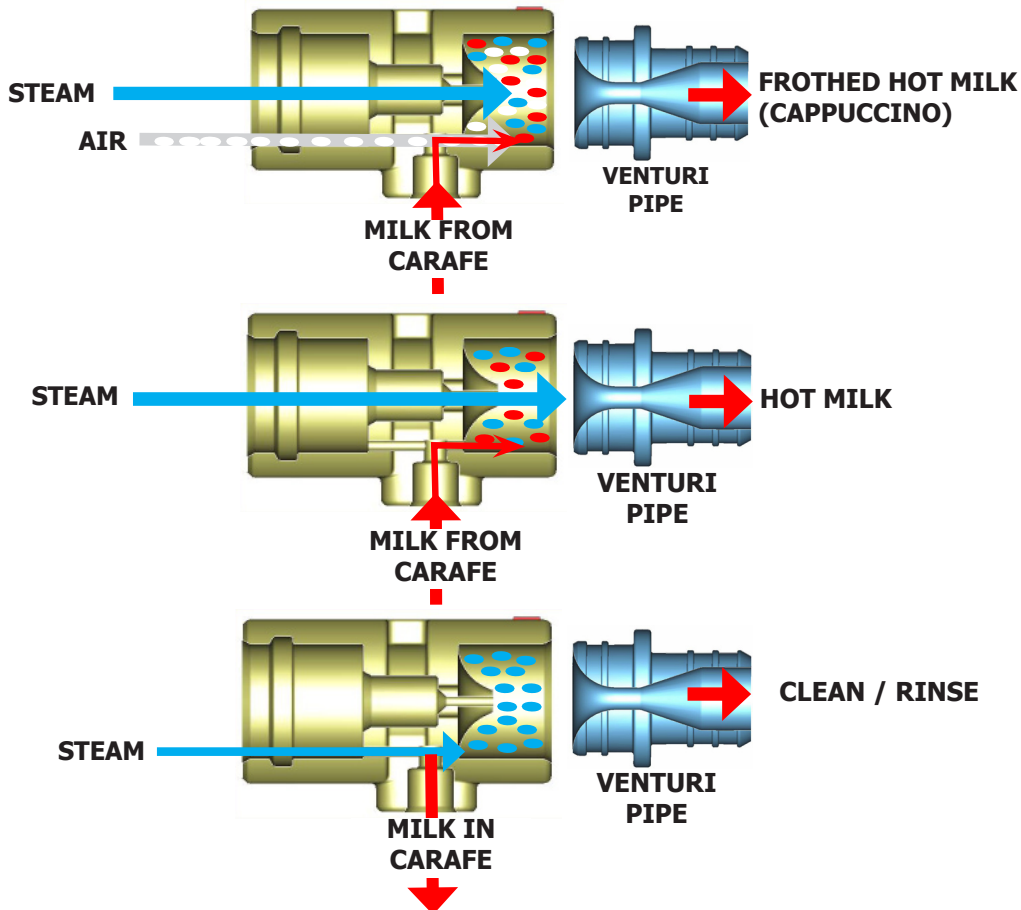
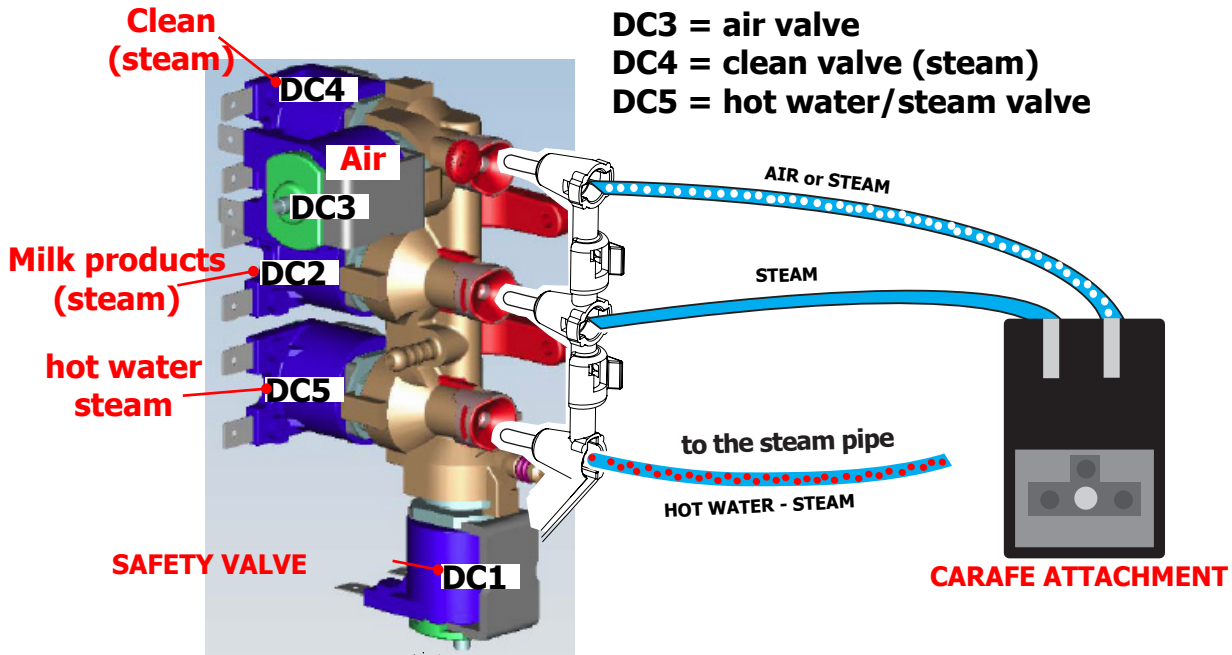

4.3. Multi-way valve

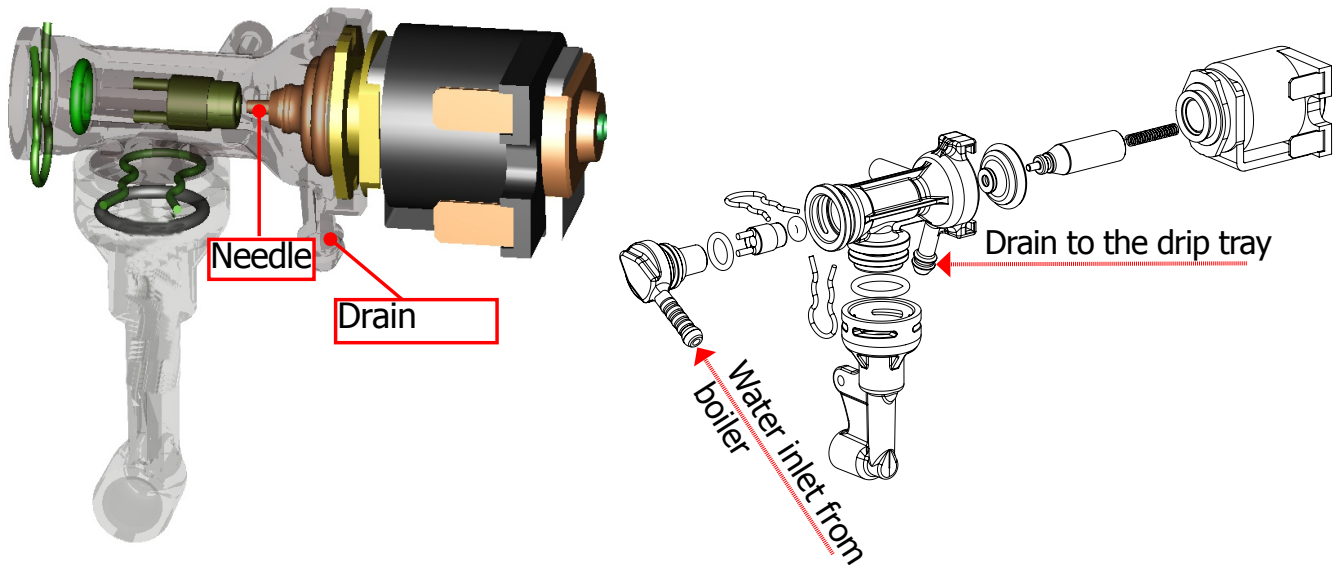

Functions:





Safety valve: opens towards the drain if the pressure exceeds 16-19 bar

Filling the circuit: the solenoid valve opens (drain position), the pump is controlled and automatically refills the circuit by expelling the air in the pipe

Draining the unit: before the unit descends, it opens briefly, releasing the pressure created to prevent the unit from spraying and making the pad drier

Coffee product: when a coffee beverage is selected, the pump is charged briefly during the grinding process and the valve assumes the drain position for hot water to pass through the pipes.

4.4. Coffee cycle

| Main Switch ON | START | | STOP |
|------------------------|---|---|--|
| Time | | | |
| Coffee grinder | | | Pulses (Dosage) |
| Heating | approx.45 sec. |  |  |
| Pump | | |  Pump action (flow meter pulses) depending on the quantity of the product set |
| Gearmotor Brewing unit |  | |  |
| Status | Heating | Ready | Coffee cycle |

Notes: * Only with Pre-brewing

| | | | |
|---------------------------|---|--|---|
| MicroSwitch Status |  |  |  |
|---------------------------|---|--|---|

Single microswitch gearmotor

Switching on

When the machine is switched on, the gearmotor repositions itself as follows:

- It stresses microswitch 1 (see the following chapter)
- The gearmotor changes the rotation direction and moves upwards again by approx. 1-2 mm
- The boiler begins to heat the water for approx. 45 sec. at full power in order to reach the optimal temperature. The temperature will then remain constant.

Coffee cycle

1. The coffee grinder starts the grinding process (controlled by pulses generated by a sensor)
2. The gearmotor (coffee unit) moves to the dispensing position
3. Preliminary dispensing phase (short pump activity, short pause)
4. The product is dispensed (the pump operation time depends on the amount of product dispensed)
5. The gearmotor moves to the idle position (the dregs are expelled automatically)

4.5. Single microswitch

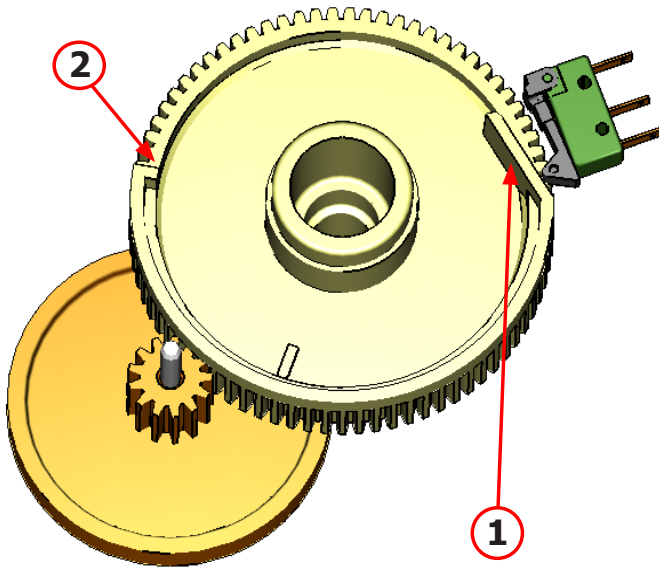

The gearmotor is activated by a direct current motor that acts on the smaller double toothed wheel via a worm screw. The unit is mounted on the axle of the large toothed wheel and when a coffee is requested, it moves from the idle position to the dispensing position to then return to the idle position.

- Idle position: 1

- Dispensing position: 2

4.6. Temperature sensor (adjustment)

| Temp. (° C) | R nom (kΩ) | ΔR (+/- %) |
|-------------|------------|------------|
| 20 | 61.465 | 8.6 |
| 50 | 17.599 | 5.9 |
| 75 | 7.214 | 4.1 |
| 80 | 6.121 | 3.7 |
| 85 | 5.213 | 3.4 |
| 90 | 4.459 | 3.1 |
| 100 | 3.3 | 2.5 |
| 125 | 1.653 | 3.9 |
| 150 | 0.893 | 5.1 |

An NTC is used as a temperature sensor and in the event of overheating, it reduces the resistors consumption.

The electronic system detects the actual boiler temperature from the drop in voltage and adjusts it accordingly.

Resistor values and corresponding temperatures: see table

4.7. Coffee grinder

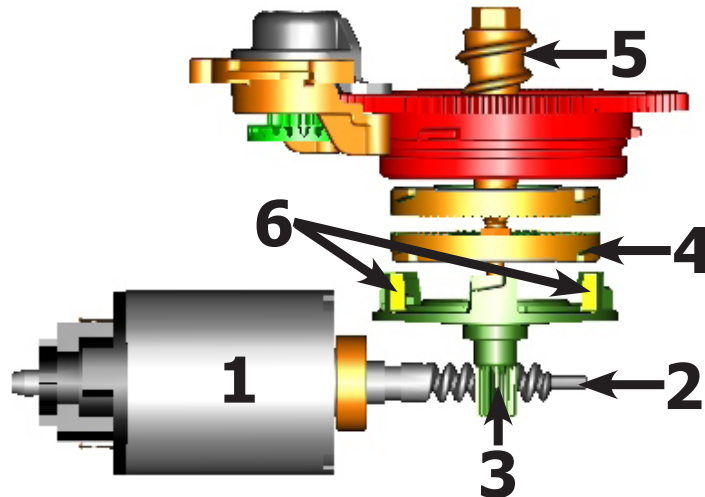

The coffee grinder is activated by a direct current motor (1) via helicoidal wheel transmission and a worm screw (2).

The worm screw (2) activates a plastic toothed wheel (3), which turns the lower grinder blade (4) and the increment pin (5).

There are two magnets (6) in the toothed wheel and with every rotation they transmit two pulses to a Hall sensor, which in turn transmits them to the electronic system.

4.8. Detection of coffee bean absence, dose adjustment, blocked coffee grinder

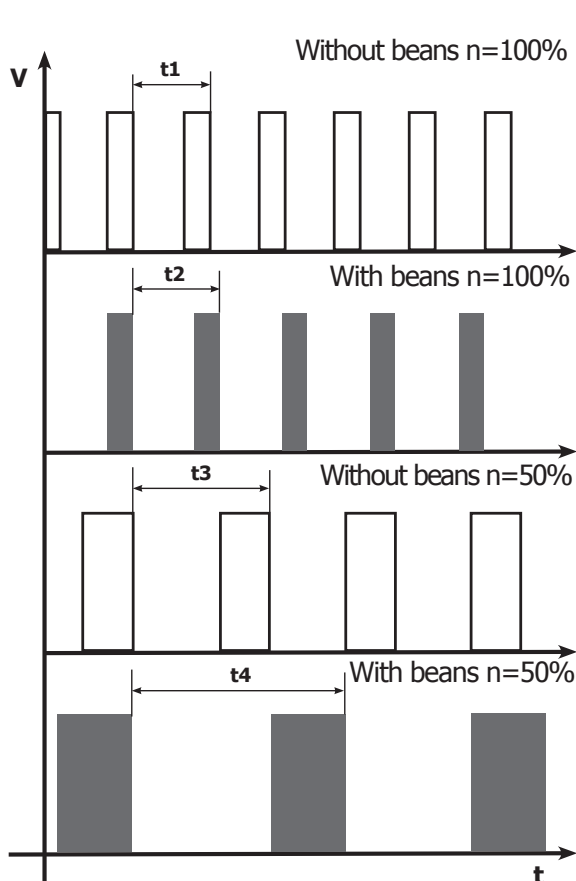

No coffee

when no coffee beans are present, this is detected by the Hall sensor due to variations in the pulse frequency (with or without coffee).

If there are no coffee beans (operation while empty), the number of rotations and therefore the number of pulses, will be greater

t1 = no coffee signal

If there are coffee beans, the number of rotations will be lower due to the force created during the grinding process

t2 = no signal

t3 and t4 = this reading is taken

at the end of each grinding process

Dose quantity adjustment

The dose quantity is adjusted in accordance with the pulses detected

(number of rotations proportional to the weak, medium and strong flavour selection)

Blocked grinder blades

If the coffee grinder is blocked for any reason, pulses will no longer be transmitted to the electronic system and the grinder stops

4.9 Auto-learning dose (SAS)

The aim of this function is to automatically adjust the average dose of ground coffee (AUTO-LEARNING); this occurs by means of an algorithm based on three pieces of information detected by the machine board:

1. Number of coffee grinder pulses during the grinding cycle
2. Max average value of the power consumed by the gearmotor during the coffee brewing cycle
3. Flavour selected by the user

The algorithm compares the maximum average value of the power consumed by the gearmotor with the value shown in the table, depending on the selected flavour, in order to calculate the new grinding pulse value for the next coffee product.

If the consumption value is less than the minimum current value, the grinding pulses will be increased by 2.

If the consumption value is greater than the maximum current value, the grinding pulses will be decreased by 4.

If the consumption value falls within the "excessive stress" range, the product is dispensed and the grinding pulses will be decreased by 10.

If the consumption value falls within the "expel" range, the pad will be expelled and the grinding pulses decreased by 10.

If the "pre-ground" flavour is selected by the user, no modification is made.

This guarantees that regardless of the coffee type used, the grinding adjustment and any wear on the grinder blades always remains constant.

| Setting / Status | | Power consumption in mA | The pulse is corrected in the next grinding process | |
|------------------|------------------|-------------------------|---|---------------------|
| | | | Exceeded in excess | Exceeded in default |
| A | Mild flavour | 200 - 300 mA | - 4 | +2 |
| B | Medium Flavour | 301 - 450 mA | - 4 | +2 |
| C | Strong Flavour | 451 - 600 mA | - 4 | +2 |
| D | Stress | 601 - 800 mA | - 4 | |
| E | Excessive stress | 801 - 1,000 mA | - 10 | |
| F | Pad expulsion | > 1000 mA | - 10 | |

Important:

For perfect operation, the adjustment is carried out in the area of the fields highlighted in green (A, B and C). When the type or brand of coffee is changed, there may be variations in the size of the beans and their stickiness or roasting level. This leads to variations in power consumption (mA), resulting in excessive or insufficient doses (until the adjustment compensates this change).

Caution: In case of an excessive dose, ground coffee can fall into the dreg drawer. This is not a fault, but can occur when the machine is switched on or following a service.

4.10. SBS

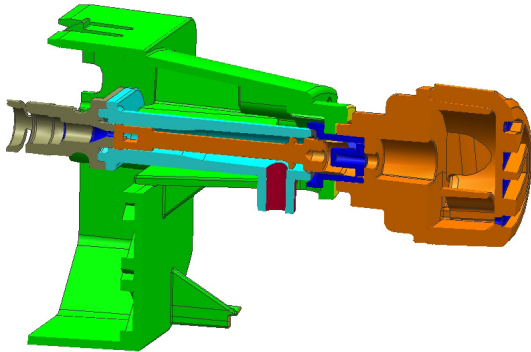

SBS Principle - Saeco Brewing System

Adjusting the flow speed, which influences the contact time between the coffee and water, alters the extraction and therefore the taste intensity and strength of the coffee.

- Slower flow: Stronger extraction
- Faster flow: Lighter extraction

SBS dispensing valve

Turning the SBS adjustment knob will trigger the brewing process in the coffee unit, where the flow speed is adjusted via a cream valve.

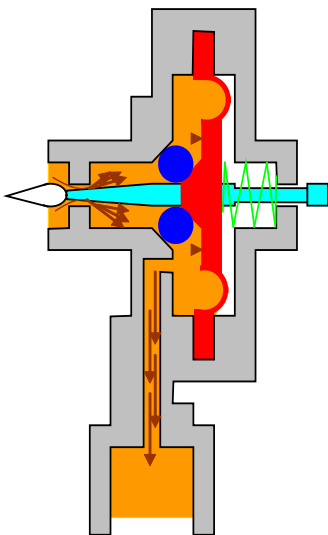

Cream valve adjustment

Greater flow (light extraction)

If the SBS valve is open, the coffee flows easily because the pressure is lower and the membrane remains almost in its base position with the help of the spring.

The adjustment needle does not close the opening and the flow does not decrease.

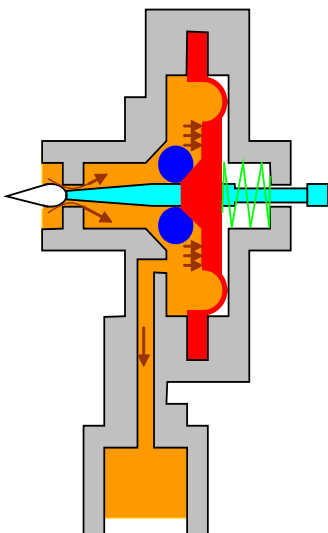

Cream valve adjustment

Slow flow (strong extraction)

The coffee is dispensed slowly with the SBS valve closed due to the pressure created, which acts on the membrane and presses it to the side against the spring force.

Lastly, the valve needle closes the opening, thereby, reducing the flow.

4.11 Water level detection in the tank

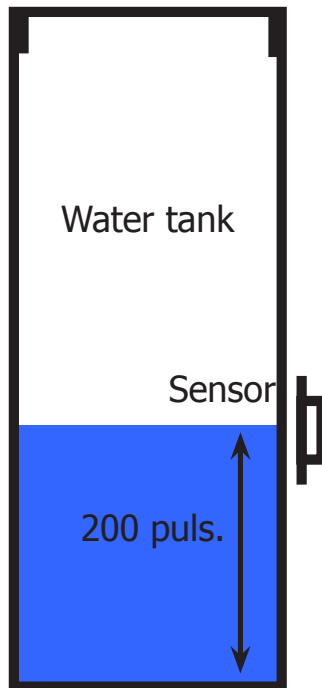

Water absence signal (water reserve)

Function:

The water level is monitored by a capacitive sensor, located one third up the water tank wall.

If the electronic system detects that the water is below the relative level by means of the sensor, a water reserve of 200 pulses of the flow meter remains available for the dispensing process.

The product dispensing process is then completed.

If a dispensing process ends after the sensor has intervened (in the reserve), the "water absence" signal continues to be displayed as from the next dispensing process

4.12. Drip tray water level detection

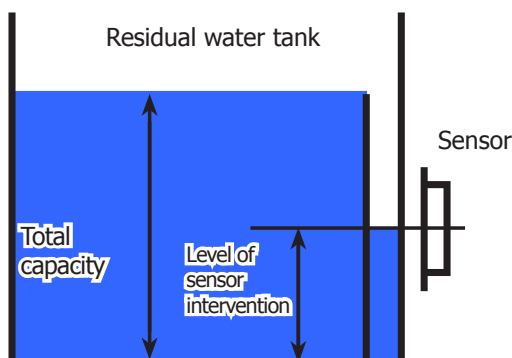

Empty residual water tank signal

Function:

The residual water level is monitored by a capacitive sensor. The sensor is located approximately half way up the upper edge of the residual drip tray. To make the best of the tray capacity, the sensor is positioned near a dam device. In this way, the residual water tray fills up to the upper edge and overflows inside and when it reaches the sensor, it triggers the "empty residual water tank" signal.

4.13. Descaling request

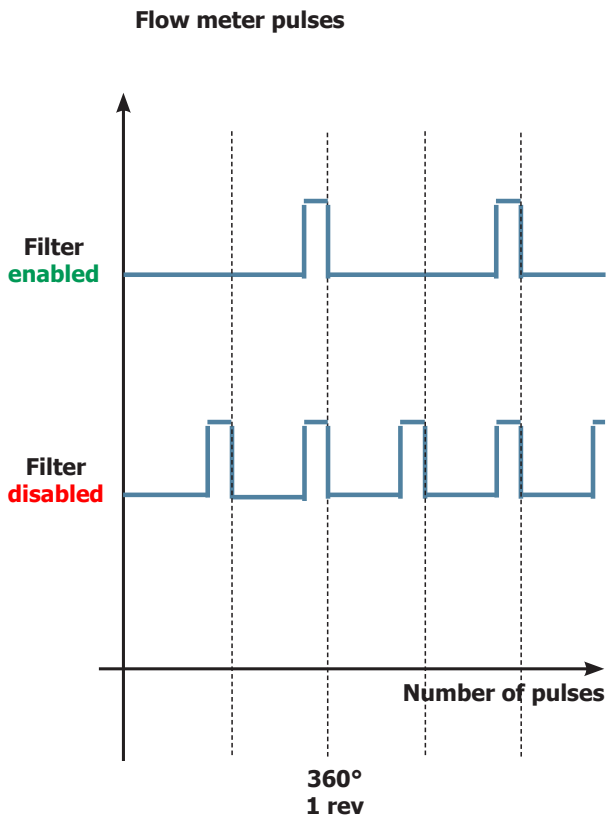

Descaling signal with anti-scale filter (only in appliances equipped with a display)

The water hardness is set on the basis of the regional water hardness analysis (1, 2, 3, 4).

Filter disabled:

If the function is **disabled**, the electronic system counts the flow meter pulses, recording **one pulse for every revolution**.

Filter enabled:

If the function is **enabled**, the electronic system counts the flow meter pulses, recording **one pulse for every two revolutions**.

"Change anti-scale filter" signal

The electronic system uses the flow meter pulses to keep track of the amount of water that flows and once the defined litres are exceeded (based on the water hardness setting), the "Replace filter" signal is triggered.

4.14 Anti-scale filter

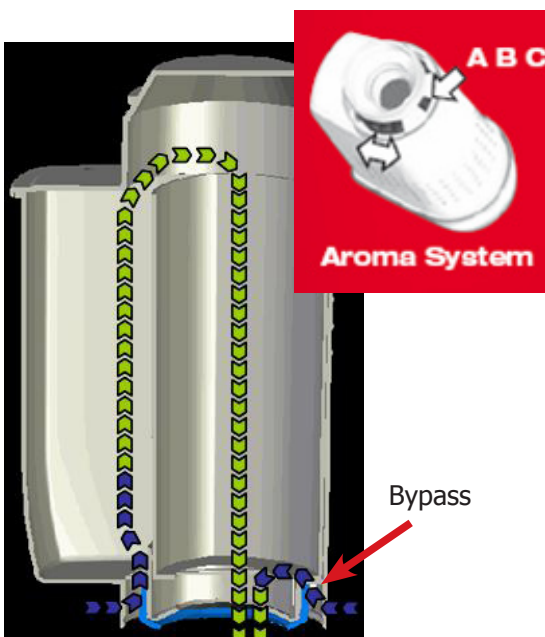

Anti-scale filter

Function:

- Reduced limescale deposits that take longer to form.
- Improved water quality.
- Better taste due to ideal water hardness.

Descaling duration / efficiency:

- - 10° dH
- 60 litres
- 2 months

To obtain a linear characteristic of its effectiveness, throughout the duration of the descaling process, the water is split according to the degree of hardness in a three-phase by-pass (A, B and C).

See small picture.

CHAPTER 5

TROUBLESHOOTING

5.1. Test mode

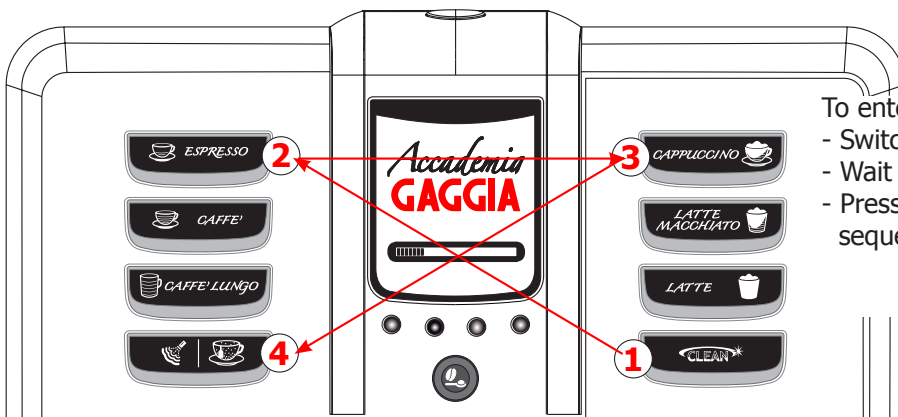

To enter Test Mode:

- Switch on the machine
- Wait for the initial progress bar
- Press the four function keys in the sequence indicated (1, 2, 3, 4)

Entering Test Mode presents a screen divided into sections as shown in the diagram below

| 1 Page title | | | |
|---------------------------|-------------------|-------------------|---------------------------|
| 1) ESPRESSO button | 13 | 14 | 5) CAPPUCCINO button |
| 2) COFFEE button | 15 | 16 | 6) LATTE MACCHIATO button |
| 3) ESPRESSO LUNGO button | 17 | 18 | 7) MILK button |
| 4) HOT WATER STEAM button | 19 | 20 | 8) CLEAN button |
| 9) MENU 1 button | 10) MENU 2 button | 11) MENU 3 button | 12) MENU 4 button |

At the top of every page of the Test Mode there is the reference number and the title

Sections 1 to 8

These can be enabled via the product buttons, as shown in the picture.

Every page of the Test Mode contains a description of the function implemented when the relative product button is pressed. When the function associated with the sector is enabled, the sector is displayed on a white background; if disabled, the background is black.

Sections 9 to 12

Indicate the function implemented when the 4 navigation buttons beneath the display are pressed.

- MENU 1 button: ESC function to exit the Test Mode
- MENU 2 button: previous page function
- MENU 3 button: next page function
- MENU 4 button: not enabled

Sections 13 to 20

Indicate the status of the system variables (sensor status or values of variables used in the software)

THE TEST MODE is split on to 5 pages

- page 1 Software Version
- page 2 Brewing Unit
- page 3 Hydraulic Circuit
- page 4 Grinder Unit
- page 5 Boiler and Steam Out

Software Version

This page provides information regarding the status of the software loaded on to the machine

| 1 Software Version | | | |
|--------------------|----------------------|-----------|-----------|
| SWISS | SW CPU: xx.yy.zz | * | * |
| DFPART 64 | SW KEYB: xx.yy.zz | * | OLD HW |
| ERPART 8 | * | * | * |
| SWITCH OFF | * | * | * |
| ESC | PAGE 5 | PAGE 2 | |

SW CPU: indicates the software version of the CPU

SW KEYB: indicates the software version of the keyboards

SWISS: indicates whether the "SWISS" function is enabled or not. It is used to control the default value of the ECO-MODE function

SWITCH OFF: indicates whether the machine goes into Stand-by once it is powered via the electromechanical switch (I/O). If so, "SWITCH OFF" is highlighted

OLD HW: manages the type of Hardware (control boards). It must be disabled for this type of machine (black background)

DFPART and ERPART: provide only information regarding save settings. Their respective values must be 64 and 8.

Brewing Unit

This page lets the user control the inner area of the front door

| 2 Brewing Unit | | | |
|----------------|-----------------------|-----------------------|------------------|
| * | BU CURRENT: (mA) 0 | DREG COUNTER 13 | * |
| BU GO WORK | BU HOME WORK | * | MAX DREG + |
| BU STOP | BU PRESENT | BU_DREG DRAWER | MAX DREG - |
| BU GO HOME | BU DOOR | * | * |
| ESC | PAGE 1 | PAGE 3 | |

CONTROLS

BU GO WORK: if pressed, the unit switches to the WORK position

BU GO STOP: if pressed, the unit is stopped instantly if it is in motion

BU GO HOME: if pressed, the unit switches to the HOME position

MAX DREG+: increases the coffee dreg counter

INDICATORS

BU CURRENT: indicates the current consumed by the unit when in motion **MAX 300mA.**

BU HOME WORK: is enabled (white) when the unit reaches a position between WORK and HOME

DREG COUNTER: indicates the coffee dreg counter value

BU PRESENT: if enabled, it indicates that the unit is connected

BU DREG DRAWER: if enabled, it indicates that the coffee dreg container is connected

BU DOOR: if enabled, it indicates that the front door is closed

Hydraulic Circuit

This page pertains to the water circuit management

| 3 Hydraulic Circuit | | | |
|----------------------------|--------------------------|---------------------------|--------------------|
| PUMP 1 COFFEE | FLOW METER (p/s) 0 | POWER FREQ. (Hz) 50 | EV DC2 STEAM |
| PUMP 2 WATER & STEAM | DRIP DRAY | WATER TANK | EV DC3 AIR |
| EV AC COFFEE | CARAFFE CLEAN | CARAFFE MILK | EV DC4 CLEAN |
| EV DC1 DISCHAR. | CARAFFE PRESENT | DRIP DRAY | EV DC5 HOTWATER |
| ESC | PAGE 2 | PAGE 4 | |

CONTROLS

PUMP1 COFFEE: if pressed, the coffee boiler pump is activated and if pressed again, it is disabled

PUMP2 WATER&STEAM: if pressed, the steam/hot water boiler pump is activated and if pressed again, it is disabled

EV_AC COFFEE: if pressed, the 230 V solenoid valve is activated

EV_DC1 DISCHARGE: activates the 24 V solenoid valve for the draining process

EV_DC2 STEAM: activates the 24 V solenoid valve to dispense the steam

EV_DC3 AIR: activates the 24 V solenoid valve to froth the milk

EV_DC4 CLEAN: activates the 24 V solenoid valve to clean the milk circuit

EV_DC5 HOTWATER: activates the 24 V solenoid valve to dispense hot water

INDICATORS

FLOW_METER: indicates the water flow rate in the flow meter, expressed in pulses per second
When coffee pump 1 is switched on (and EV_AC_COFFEE is on), the value must not be less than 10 p/s.
When the hot water/steam pump 2 is switched on (and EV_DC_DISCHARGE is on), the value must not be less than 5 p/s.

POWER_FREQ.: indicates the frequency of the power supply voltage

DRIP DRAY: indicates the status of the tray level sensor. If enabled, it indicates that the level has been reached

WATER TANK: indicates the status of the water tank level sensor. If enabled, it indicates that the level has been reached

CARAFFE CLEAN: if enabled, it indicates that the milk carafe is in the CLEAN position

CARAFFE MILK: if enabled, it indicates that the milk carafe is in the MILK dispensing position

CARAFFE PRESENT: if enabled, it indicates that the milk carafe is connected

Grinder Unit

This page pertains to the coffee grinder and cup heater management.

CONTROLS

| 4 Grinder Unit | | | |
|----------------|--------------------|--------------------|------------------|
| * | GRINDER PULSE 0 | MEDIUM DOSE 100 | * |
| GRINDER GO | BEAN FACTOR 20 | BEAN LESS 28 | MEDIUM DOSE + |
| CUP HEATER | BEAN DOOR | BEAN LESS ALARM | MEDIUM DOSE - |
| BEAN LESS TEST | NET STABLE | | * |
| ESC | PAGE 3 | PAGE 5 | |

GRINDER GO: if pressed, the coffee grinder is activated. To stop it, press the button again. If it is not stopped, it will grind for 200 pulses and the corresponding countdown appears in the window.

CUP HEATER: if pressed, the cup heater is activated. It is switched off by pressing the button again.

BEAN LESS TEST: if pressed, the coffee presence/absence test is performed. When the coffee grinder is activated, a number of pulses equal to the number set for the "MEDIUM DOSE" is performed. At the end of the grinding cycle, the values of the "BEAN FACTOR" and "BEAN LESS" sections are updated and if the absence of coffee is detected, the "BEAN LESS ALARM" section is enabled

MEDIUM DOSE +: if pressed, the average dose value displayed in "MEDIUM DOSE" is increased

MEDIUM DOSE -: if pressed, the average dose value displayed in "MEDIUM DOSE" is decreased.

INDICATORS

GRINDER_PULSE: indicates the real-time grinding pulse countdown during the grinding process

MEDIUM_DOSE: indicates the pulses pertaining to the average dose

BEEN FACTOR: indicates the result of the last grinding cycle, calculated using the automatic dose adjustment algorithm. The default value is 17 and is dynamically updated with the grinding cycles.

BEEN LESS: indicates the threshold set by the dynamic threshold algorithm for the absence of coffee to be detected

BEEN DOOR: indicates the status of the bean container door sensor (if enabled, it indicates that the door is closed)

BEEN LESS ALARM: indicates the result of the coffee presence/absence test (if enabled, it indicates the absence of coffee)

NET STABLE: indicates whether the mains maintained a stable frequency during the last grinding process, in order to ensure the coffee absence algorithm is functions correctly. If the section is enabled, the frequency is stable.

Boilers & SteamOutUnit

This page pertains to the management of the boilers and the "STEAM OUT" cycle (emptying of the coffee and hot water/steam boiler circuits)

| 5 Boilers & SteamOut | | | |
|---------------------------------|---------------------|---------------------|-----------------------|
| BOILER1 | BOILER1 XX.X (C) | BOILER2 XX.X (C) | START STEAM OUT |
| BOILER2 | END TIMER 0 | * | * |
| * | * | * | * |
| * | * | * | * |
| ESC | PAGE 4 | PAGE 1 | |

Controls

BOILER1 (°C): if pressed, the coffee boiler is activated. The boiler is disabled by pressing the button once again or automatically after 5 seconds. The temperature is shown in the BOILER1(C) window.

BOILER2 (°C): if pressed, the steam/hot water boiler is activated. The boiler is disabled by pressing the button once again or automatically after 5 seconds. The temperature is shown in the BOILER2(C) window.

START STEAM-OUT: if pressed, the steam-out procedure is activated and the text linked to the button is highlighted. The cycle ends when the two boilers (boiler1 and boiler2) reach 100 °C and at least 5 seconds have elapsed.

INDICATORS

BOILER1 (°C): indicates the temperature of coffee boiler 1

BOILER2 (°C): indicates the temperature of hot water/steam boiler 2

TIME-OUT(sec): indicates the remaining time for the steam-out cycle to end

5.2. Diagnosis mode

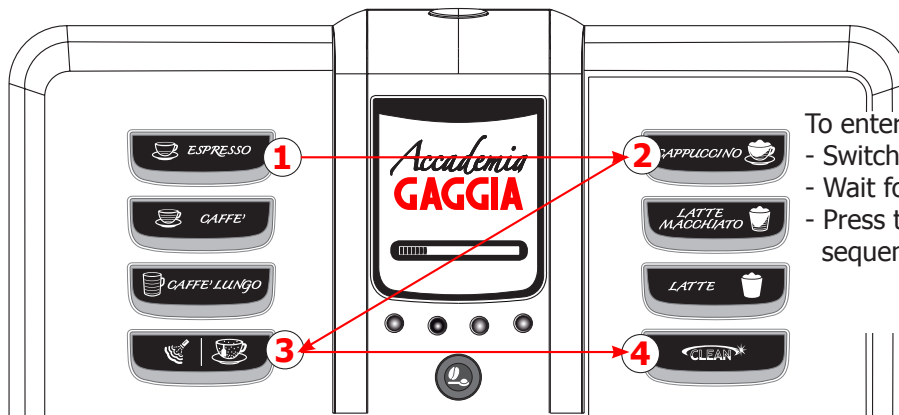

To enter Diagnosis Mode:

- Switch on the machine
- Wait for the initial progress bar
- Press the four function keys in the sequence indicated (1, 2, 3, 4)

Entering the Diagnosis Mode presents the main eight menu options.

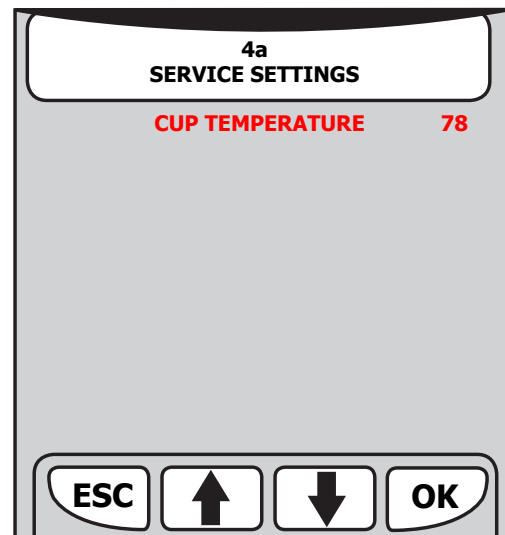
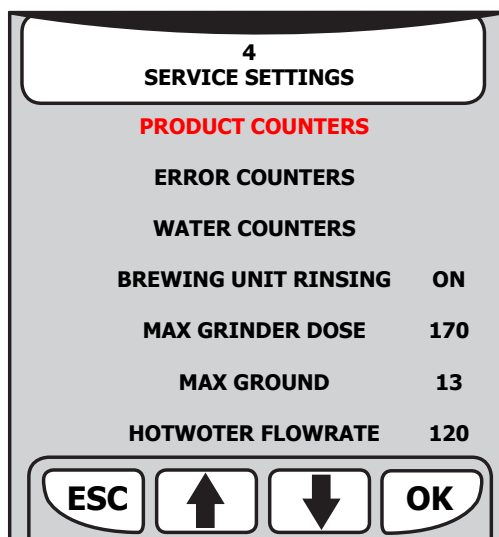

PRODUCT COUNTERS



The number of dispensing cycles performed by the machine is displayed for each product.

The counters cannot be reset.

The value may be different from that shown in the user menu as the latter can be reset.

Press ESC to return to the main menu.

ERROR COUNTERS

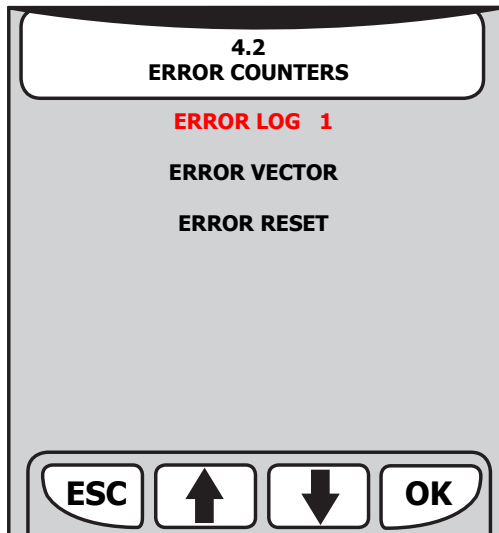

ERROR LOG: displays the total number of errors that have occurred in the system.

If no errors are present, input "0" in the submenu is disabled.

ERROR VECTOR: select this to display the type of error that has occurred in the system.

ERROR RESET: select this to reset all the errors that have occurred in the system.

ERROR LOG

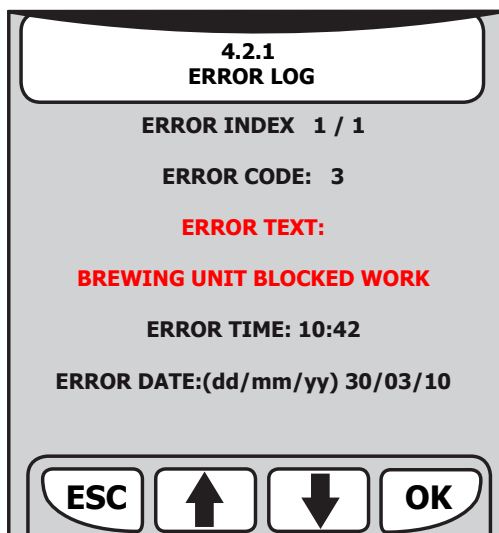

A maximum of 20 errors may be saved and displayed (when the 21st error occurs, the system saves it by deleting the first error read).

ERROR INDEX: displays the numerical position of the error.

ERROR CODE: represents the numeric code pertaining to the type of error that has occurred.

See paragraph 5.3. Error messages.

ERROR TEXT: a brief description of the error that has occurred. See paragraph 5.3. Error messages.

ERROR TIME: the time at which the error occurred.

ERROR DATE: the date when the error occurred.

ERROR VECTOR

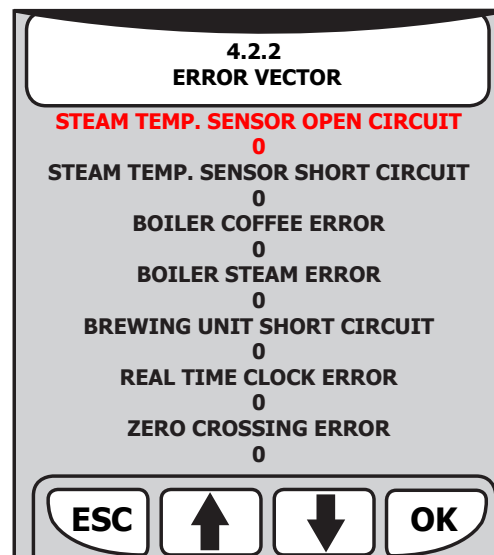
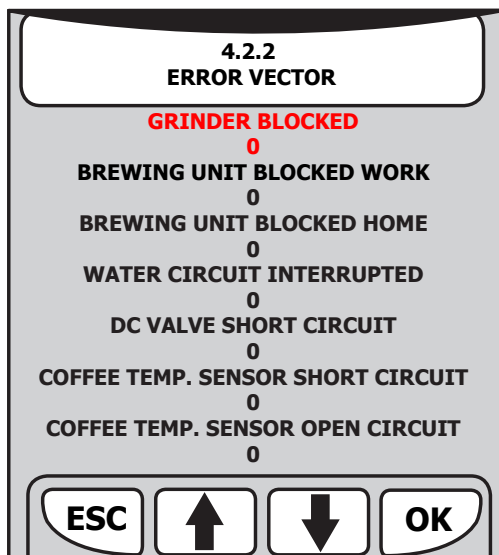

Displays the number of times that a given error has occurred, from when the machine was first switched on or when the counters were last reset (ERROR RESET function).

ERROR RESET

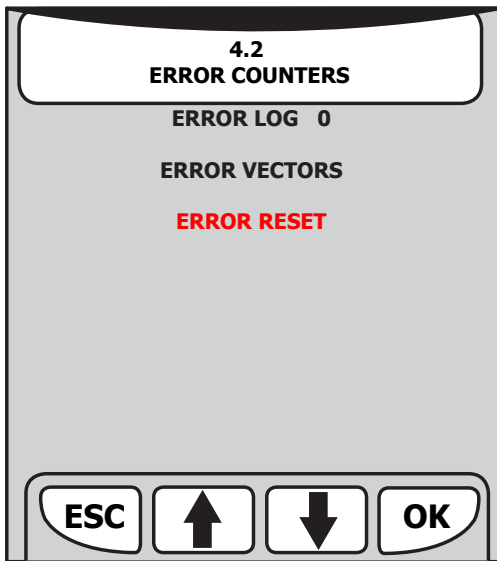

ERROR RESET: press **OK** to reset all the error counters displayed previously.

WATER COUNTERS

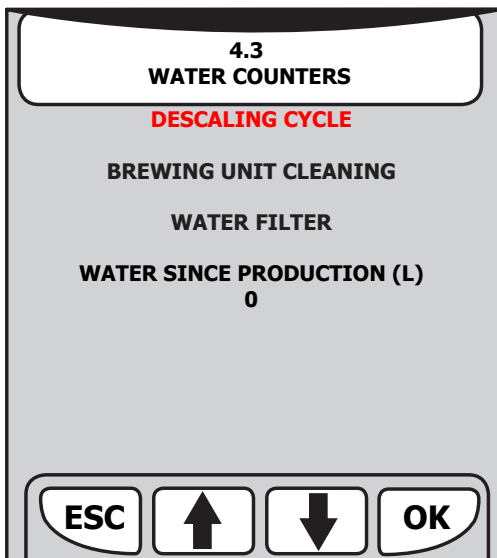

Provides information regarding maintenance of the water circuit

DESCALING CYCLE

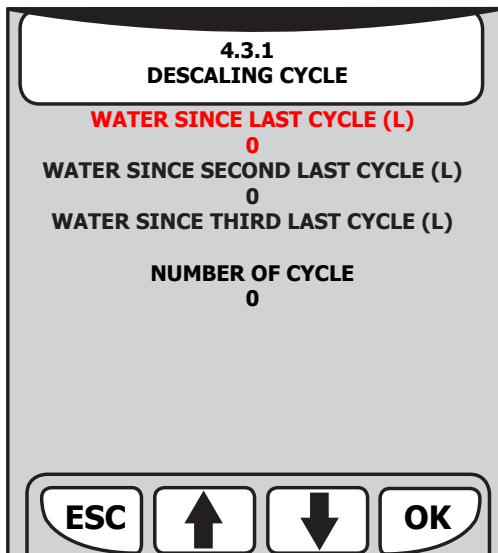

Select and press "OK" to enter the submenu pertaining to the descaling cycle.

WATER SINCE LAST CYCLE: displays the amount of **litres of water** since the last descaling process

WATER SINCE SECOND LAST CYCLE: displays the amount of **litres of water** since the second last descaling process

WATER SINCE THIRD LAST CYCLE: displays the amount of **litres of water** since the third last descaling process

NUMBER OF CYCLE: the number of descaling cycles performed

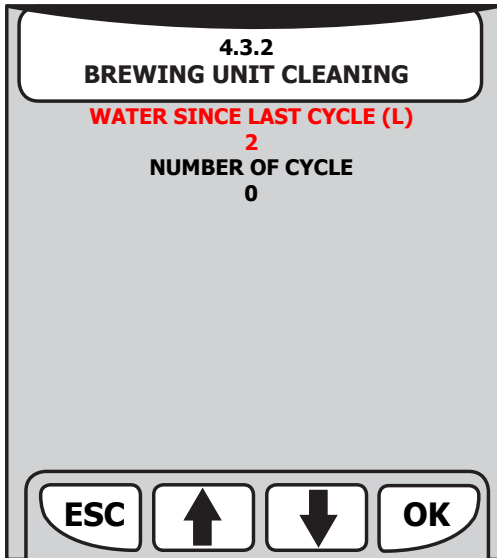
BREWING UNIT CLEANING

WATER SINCE LAST CYCLE: represents the water consumption in litres since the last unit cleaning cycle. (after each unit cleaning cycle, the value is reset to "0").

NUMBER OF CYCLE: represents the number of unit cleaning cycles performed

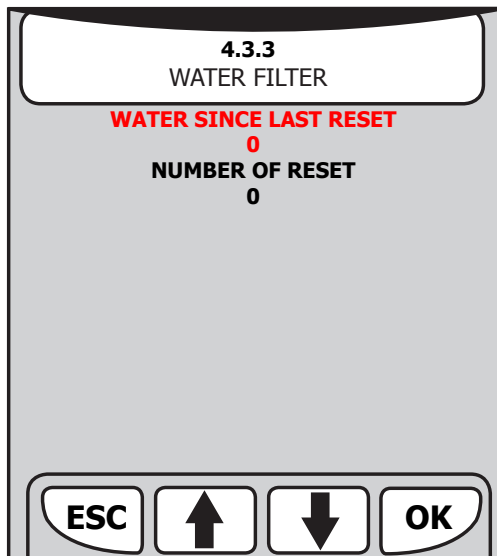
WATER FILTER

WATER SINCE LAST CYCLE: represents the water consumption in litres since the last time the water filter was enabled. (after each water filter activation, the value is reset to "0").

NUMBER OF RESET: represents the number of water filter activation cycles performed.

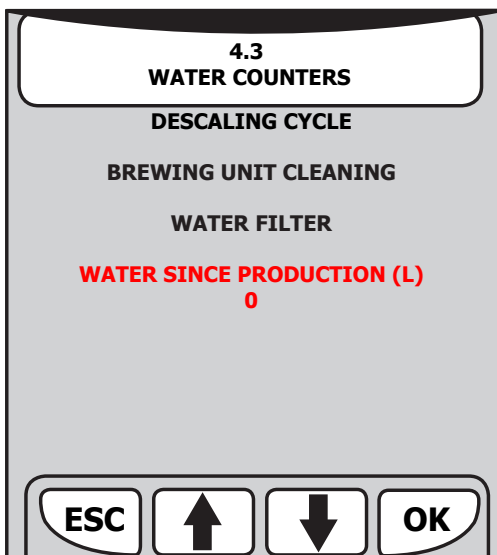
WATER FILTER

WATER SINCE PRODUCTION: indicates the number of litres of water used since the machine was first switched on

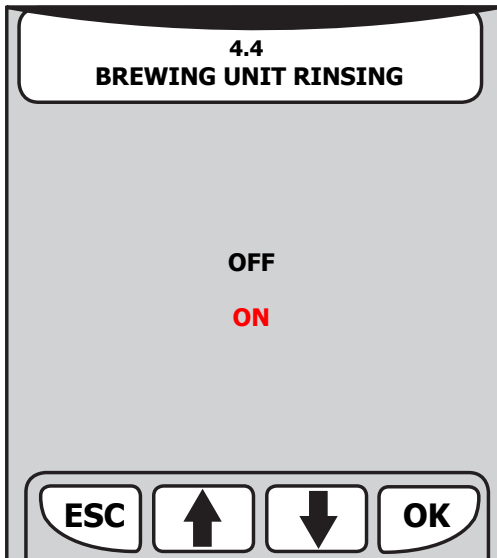
BREWING UNIT RINSING

Indicates the initial rinse activation status when switched on or when exiting the stand-by mode.

If this is ON, the rinse cycle is enabled; if it is OFF, the rinse cycle is disabled.

The default setting is ON.

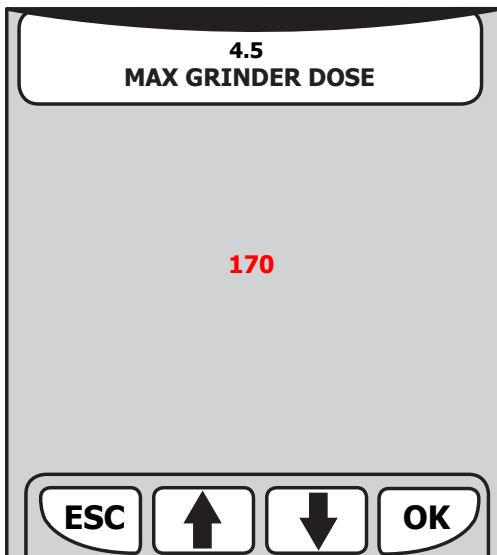
MAX GRINDER DOSE

Indicates the maximum value of pulses of the coffee grinder for the automatic dose adjustment algorithm.

Press "OK" to edit the setting.

The range can vary from 100 to 170, with intervals of 5.

The default value is 170.

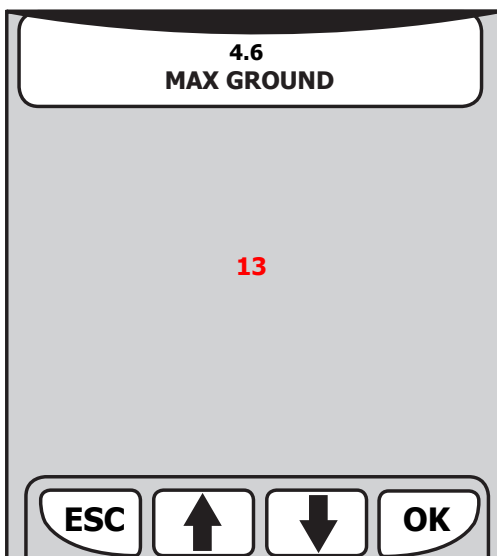
MAX GROUND

Indicates the maximum number of coffee dregs in the dreg container.

Press "OK" to edit the setting.

The default value is 13.

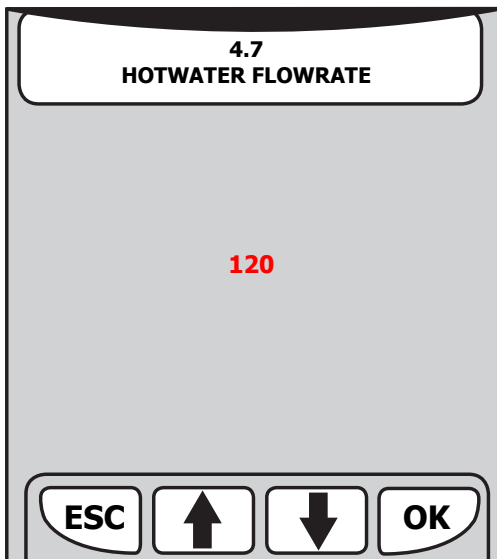
HOTWATER FLOWRATE

Indicates the capacity (in litres/hour) of the hot water / steam circuit pump.
Press "OK" to edit the setting.
The default value is 120.

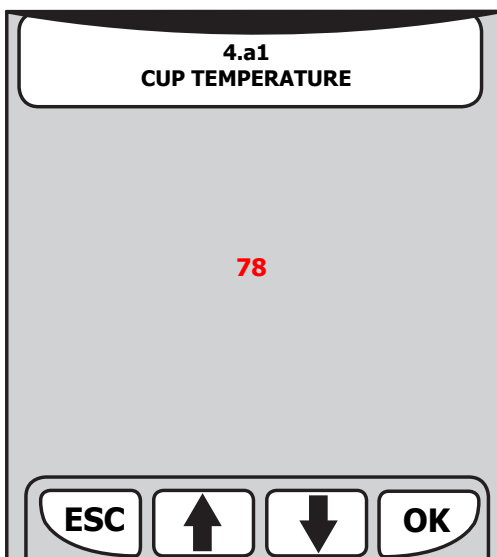
CUP TEMPERATURE

Indicates the reference temperature in °C of the poured coffee. Press "OK" to edit the setting.
Increasing or decreasing it will change the temperature of the coffee.
The default value is 78.

5.3. Error messages

| code | brief description | description |
|-------------|---|---|
| 01 | blocked coffee grinder | the coffee grinder is blocked (jammed grinder blades or sensor is not reading properly) |
| 03 | brewing unit blocked in 'work' | descending time-out exceeded |
| 04 | brewing unit blocked in 'home' | ascending time-out exceeded |
| 05 | blocked water circuit | water does not flow in the flow meter |
| 06 | frother unit solenoid valve | short circuit in a solenoid valve of the frother unit |
| 10 | coffee boiler short circuit | coffee boiler temperature sensor short circuit |
| 11 | coffee boiler in open circuit | coffee boiler temperature sensor in open circuit |
| 12 | steam boiler short circuit | steam boiler temperature sensor short circuit |
| 13 | steam boiler in open circuit | steam boiler temperature sensor in open circuit |
| 14 | various temperature errors (in the coffee boiler) | coffee boiler temperatures out of control |
| 15 | various temperature errors (in the steam boiler) | steam boiler temperatures out of control |
| 16 | coffee unit short circuit | brewing unit microswitch short circuit |
| 17 | not used | |
| 18 | clock error | memory fault or impossible to set |
| 19 | no zero crossing | no zero crossing on board, could also be caused by the power board |
| 20 | not used | |

CHAPTER 6

STANDARD INSPECTIONS

6.1. Repair schedule

| | Action |
|-----------|--|
| 1 | Visual inspection (damage during transport) |
| 2 | Machine data check (plate) |
| 3 | Functional check / problem analysis |
| 4 | Opening the machine |
| 5 | Visual inspection |
| 6 | Functional tests |
| 7 | Repairing the faults encountered |
| 8 | Checking any modifications (view info, new sw, etc.) |
| 9 | Service activities in accordance with the operating schedule |
| 10 | Internal cleaning |
| 11 | Functional test with the machine open |
| 12 | Assembly |
| 13 | Final inspection test |
| 14 | Draining the circuit (in winter) |
| 15 | External cleaning |
| 16 | Lubricating the brewing unit with suitable grease |
| 17 | Insulation test HG 701 (dielectric) |
| 18 | Documentation |

6.2. Service schedule

| | |
|-----------|-------------------|
| S | Replacement |
| ES | Visual inspection |
| D | Descaling cycle |
| CF | Functional check |

| | |
|-----------|----------------|
| P | Cleaning |
| TR | Noise test |
| R | Grinding level |

| Component | Action | Support/tool |
|------------------------------------|-----------------|------------------------|
| Water filter | P/S/CF | |
| Water tank lip seal | S/CF | |
| Boiler pin O-ring | S/CF | |
| Brewing unit | ES/P/CF | Degreaser / Grease |
| Pipes, fittings and Oetiker clamps | ES/CF | |
| Coffee circuit pump | ES/TR/CF | |
| Hot water/steam circuit pump | ES/TR/CF | |
| Gearmotor | ES/TR/CF | |
| Coffee grinder | P/R/CF | Vacuum cleaner / brush |
| Water circuit | D/CF | Saeco descaler |
| Frothing valve assembly | ES/S/CF | |
| Multi-way valve (solenoid pilot) | ES/S/CF | |

6.3. Final inspection

| Test | Procedure | Support/ tool | Standard | Tolerance |
|----------------------------|---|--------------------------|---|------------------|
| Espresso | 2-3 Expressos for adjustment purposes | Measuring beaker | Same amount | 15% |
| Coffee | 2-3 Coffees for adjustment purposes | Measuring beaker | Same amount | 15% |
| Noise | | | Standard | |
| Amount of cream | Blow into the cup until the cream separates | | The cream should come together again completely | |
| Cream colour | | | Hazel brown | |
| Temperature | Reading taken while dispensing | Thermometer | 84 °C | ± 4 °C |
| Grinding level | Check the grain size of the ground coffee | | | |
| Hot water | Dispense water | | | |
| Steam | Dispense steam | | | |
| Dreg drawer absence signal | Remove the dreg drawer | | Dreg drawer absence signal | |
| Coffee bean absence signal | Start brewing a coffee with the coffee bean container empty | | Coffee bean absence signal | |

CHAPTER 7

DISASSEMBLY

7.1. Outer elements



Remove the water tank, the coffee container cover, the water drip tray, the coffee dispenser and the carafe.

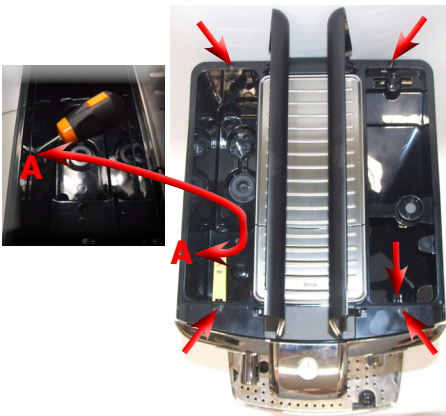

Loosen the screws shown and press inside the slot (A) with a flathead screwdriver



Remove the connection as shown (connection to the cup heater board)

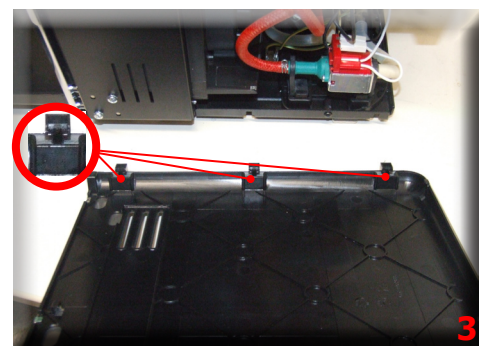
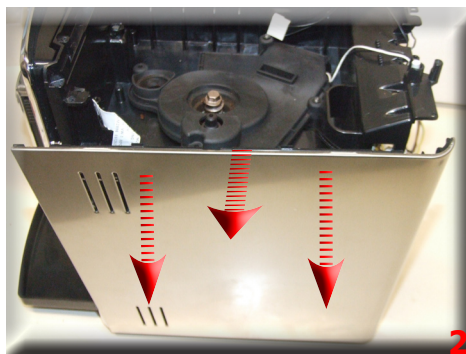
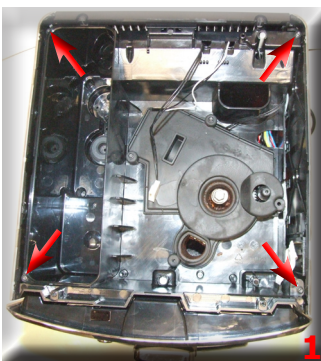

- 1) Loosen the screws as shown
- 2 - 3) Move the cover outwards and press downwards to release the anchoring teeth
- 4) Repeat the procedure for all covers

7.2. Coffee grinder

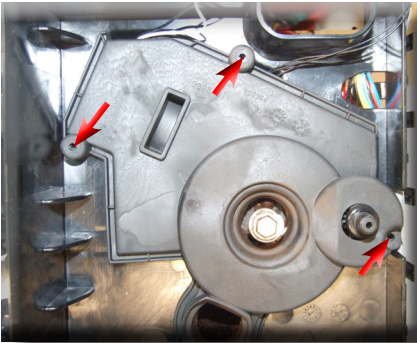

Loosen the screws as shown and remove the sound insulating cover of the coffee grinder

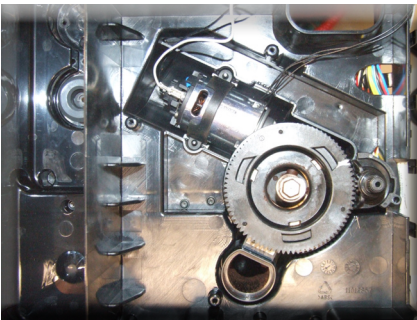

Lift the coffee grinder

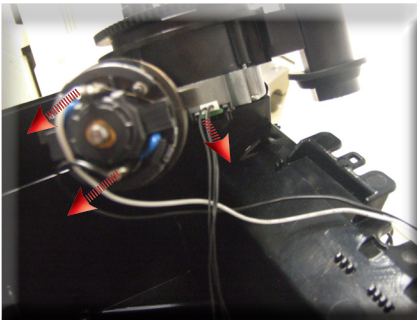

Remove the connections shown

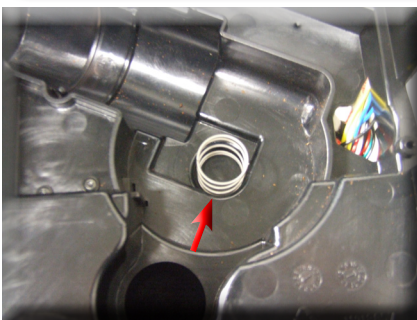

When reassembling the coffee grinder, make sure the spring is repositioned correctly (see picture)

7.3. Grinder blades

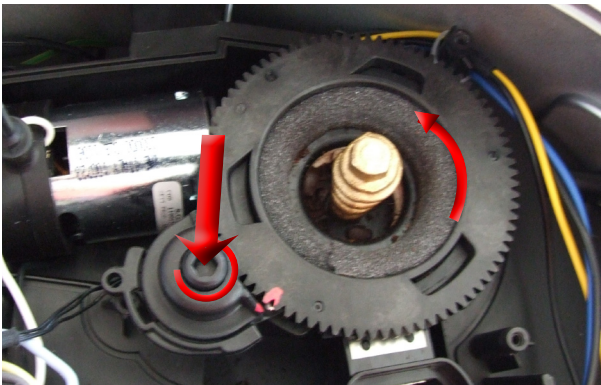

Press down on the grinder adjuster and turn the upper grinder blade support anti-clockwise until it stops.

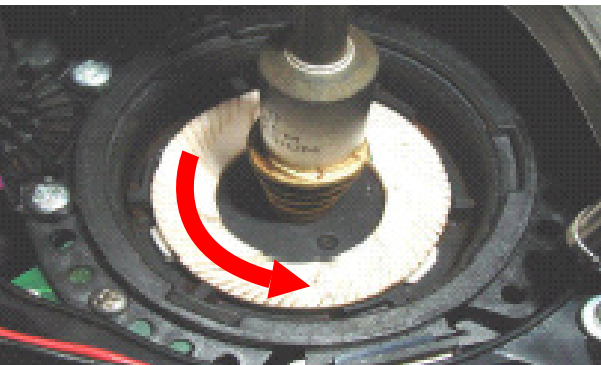

Turn the grinder blades anticlockwise from the support.



Turn the grinder blades clockwise from the support. The bayonet fittings can be accessed from the rear.

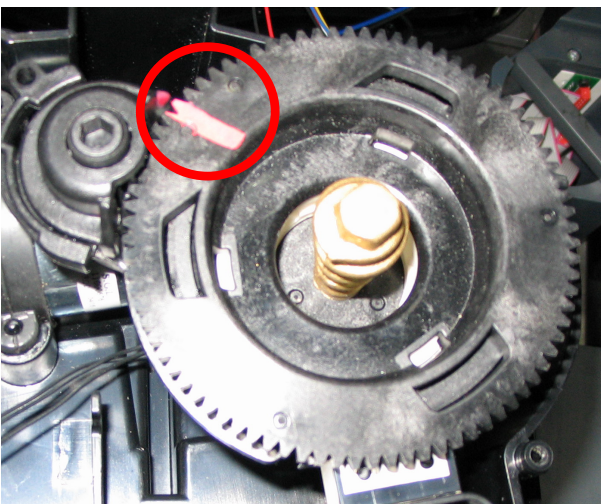

The two notches must overlap in order to adjust the base.

7.4. Coffee grinder adjustment

The grinding machine can be adjusted by the user (only with the grinding machine on) by pressing and turning the knob inside the coffee bean container one notch at a time

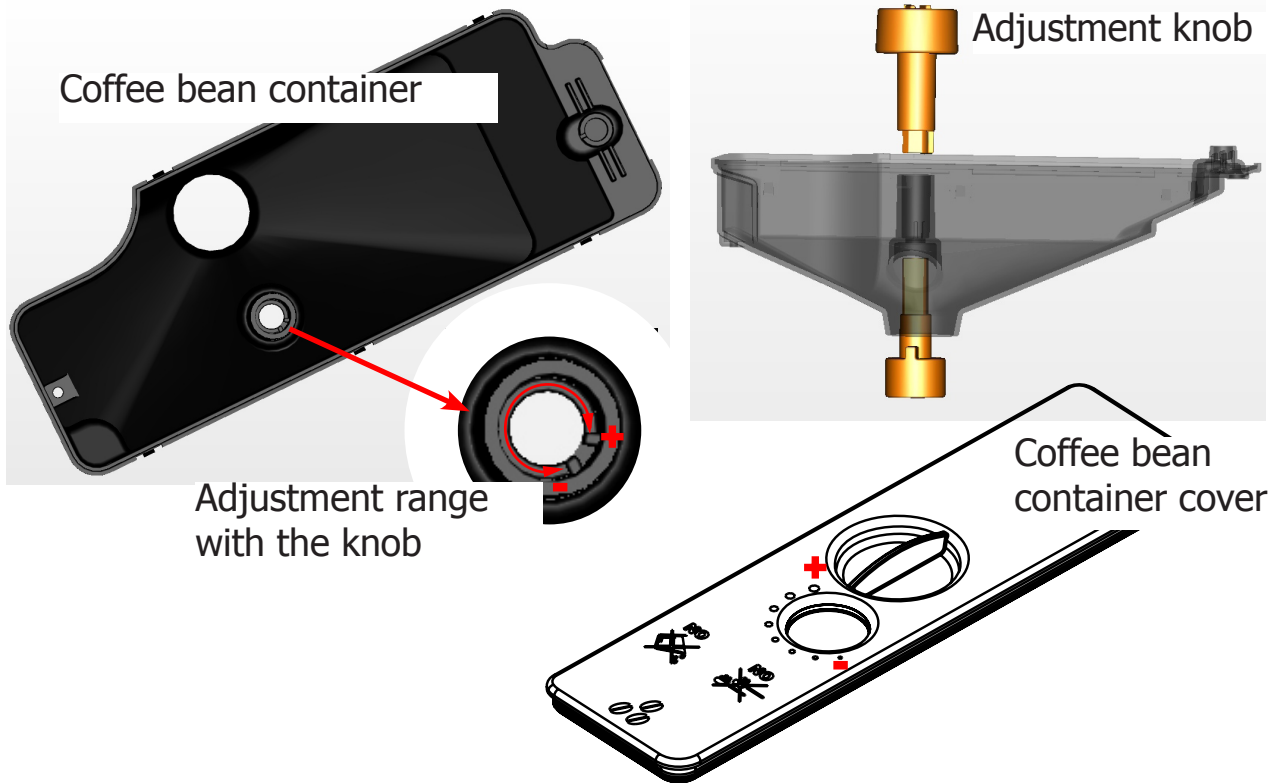

Adjustment implemented by the assistance centres

To further adjust the grinding machine, the technician can operate directly on the machine by pressing and turning the highlighted ring nut (C) (clockwise + to increase the grain size and anti-clockwise - to decrease it)

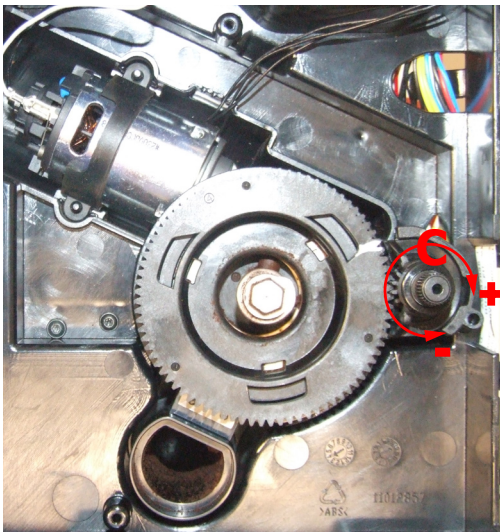

If coffee residue is found between the two grinder blades, it is recommended to adjust this by tightening a max of two notches at a time.

Lastly, bring the arrow (A) on the adjustment knob back to the centre of the adjustment dots on the cover (B).

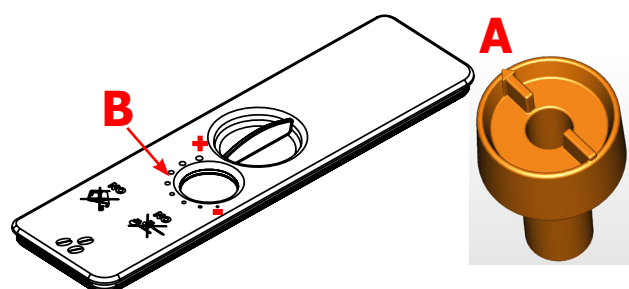

7.5. Steam pump

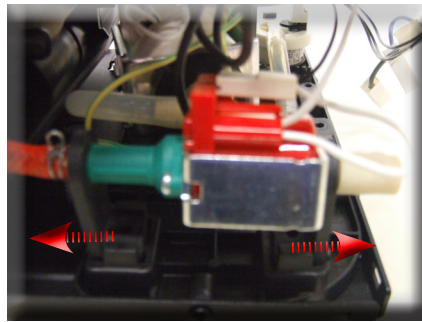

Remove the two pump supports (highlighted) anchored to the structure and disconnect the electrical and water connections

7.6. Coffee pump

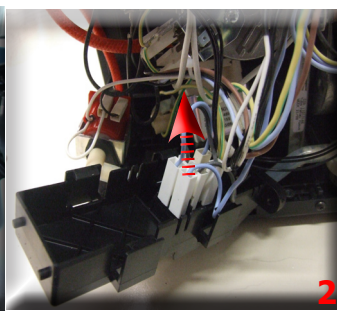
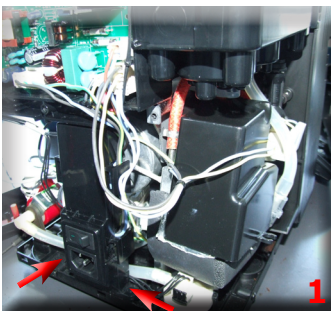

- 1) Loosen the screws as shown
- 2) Remove the connections from the component support. This process facilitates removing several components (coffee pump, boiler, etc.)

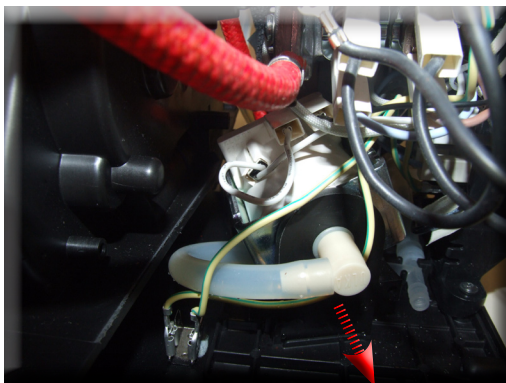

Remove the two pump supports (highlighted) anchored to the component support and disconnect the electrical and water connections

7.7. Flow meter

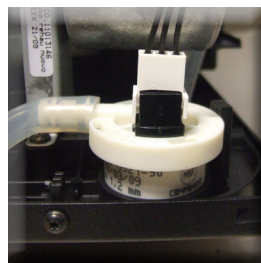
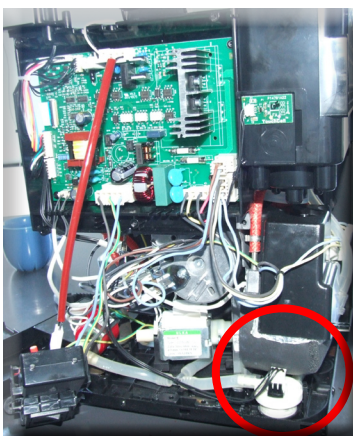

Lift the flow-meter from the component support and remove the electrical and water connections

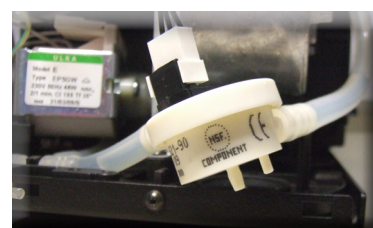

7.8. Power Board

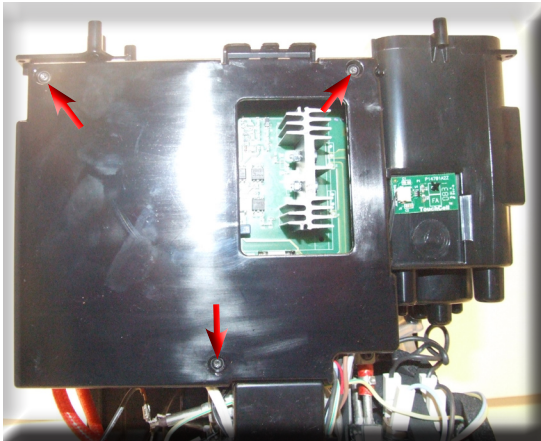

1) Loosen the screws as shown and remove the board cover

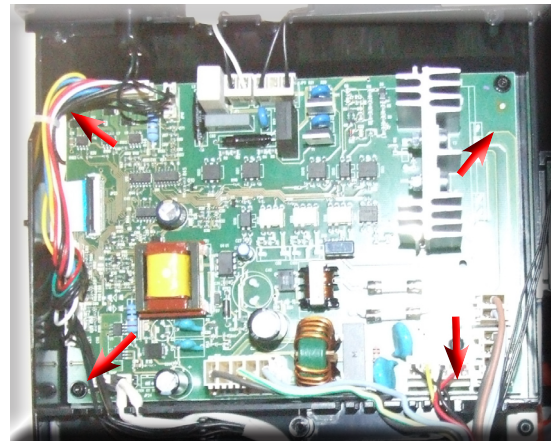

2) Loosen the screws as shown and remove all the electrical connections

7.9. Steam boiler

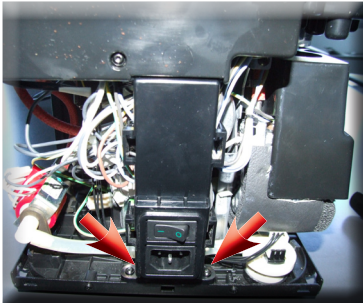

Remove the screws as shown and the component support

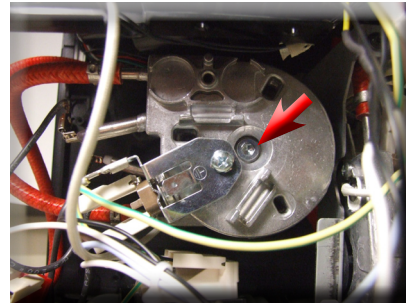

Loosen the screw as shown and remove the electrical and water connections

7.10. Coffee boiler

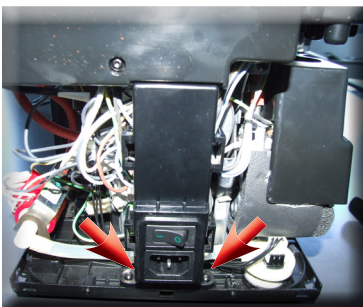

Remove the screws as shown and the component support

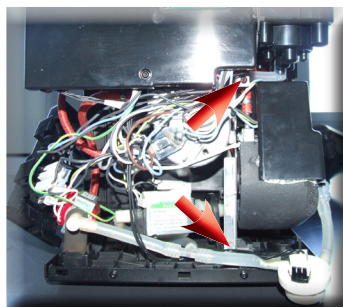

Loosen the screws as shown, remove the boiler assembly support and the electrical and water connections

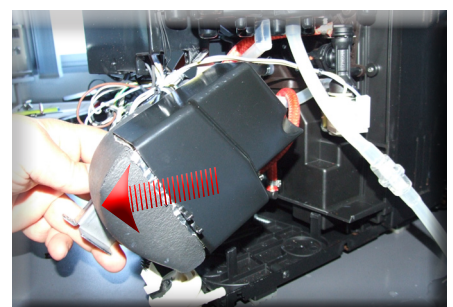

7.11 Gearmotor

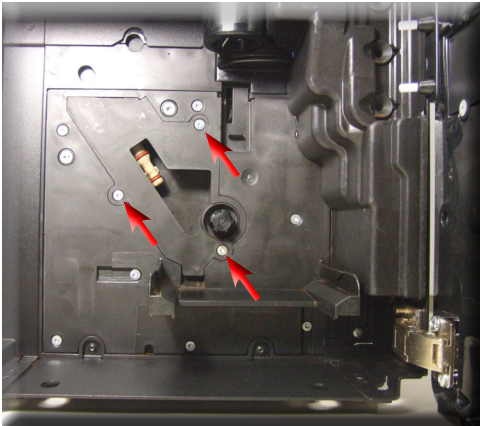

Loosen the screws as shown and remove the boiler pin

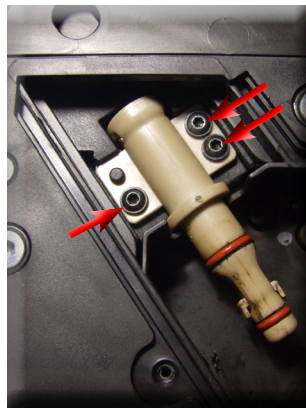

Loosen the screws as shown and remove the boiler pin

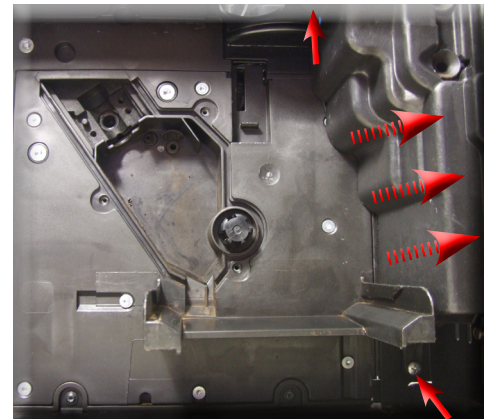

Loosen the screws as shown and remove the frothing valve protection

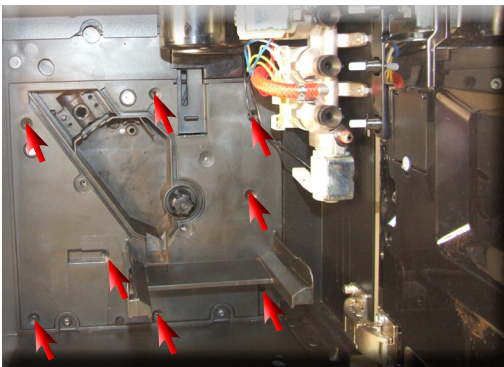

Loosen the screws as shown and remove the gearmotor cover

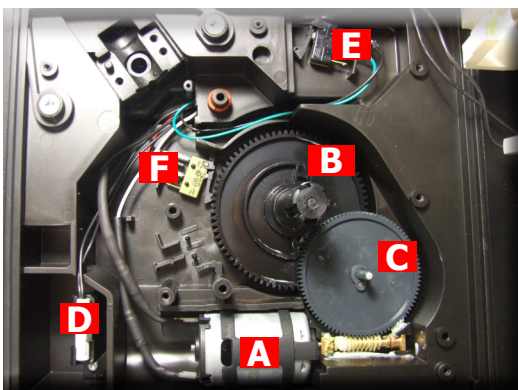

The following are located inside the compartment protected by the casing:

- The electric motor (A) with gears (B) and (C) for transmission and timing of the dispensing unit.
- The dreg drawer presence sensor (D).
- The dispensing unit presence microswitch (E).
- The microswitch (F) that detects the idle phase of the dispensing unit as well as that of the dispensing process.
- Remove the gear (C) that engages with the motor transmission shaft motor transmission.
- Remove the large gear (B).
- Remove the motor (A) complete with the transmission shaft.
- (G) Drain multi-way valve.

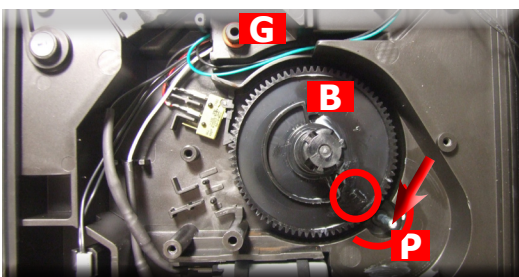

Reconnect the gear (B), making sure that the arrow is aligned with the opening that contains the pin (P).

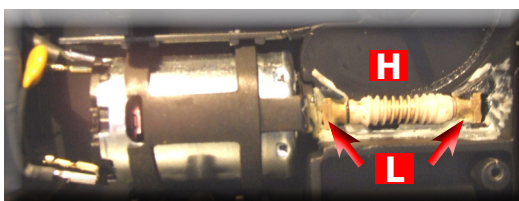

When re-mounting the motor and the transmission shaft, make sure the guides (L) are inserted in the correct housing.
Grease the shaft thoroughly and evenly.

7.12. Frother valve assembly

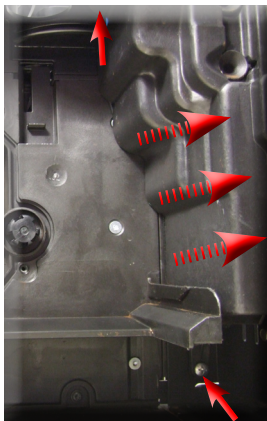

Loosen the screws as shown and remove the frothing valve protection

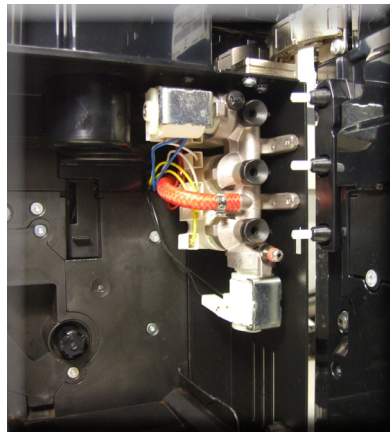

Loosen the screws as shown, making sure that the frothing valve does not fall and damage the connections

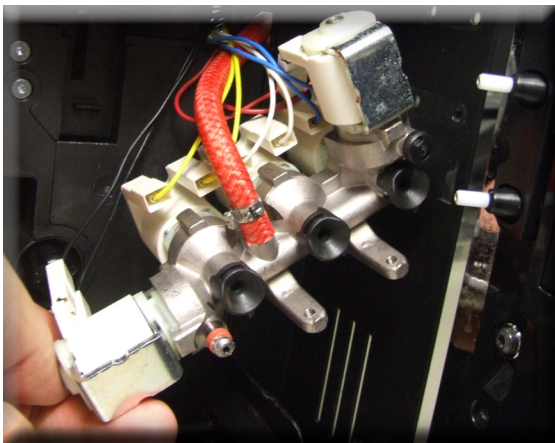
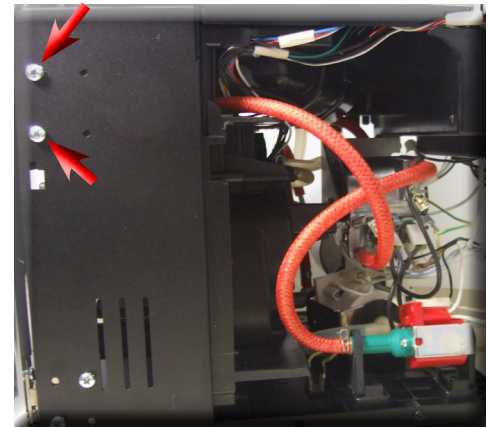

Disconnect the electrical and water connections

7.13. Dispenser assembly

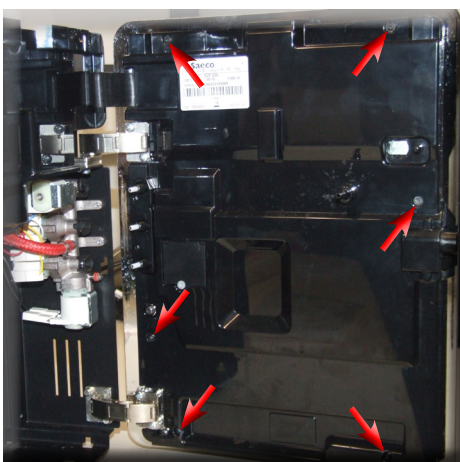

Loosen the screws as shown to remove the inner cover of the front panel

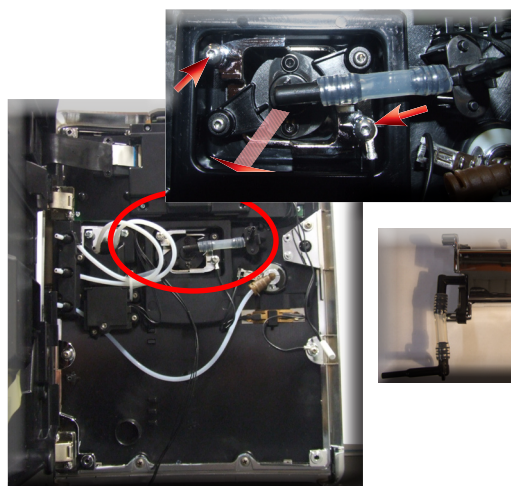

Loosen the screws as shown and remove the coffee dispenser assembly

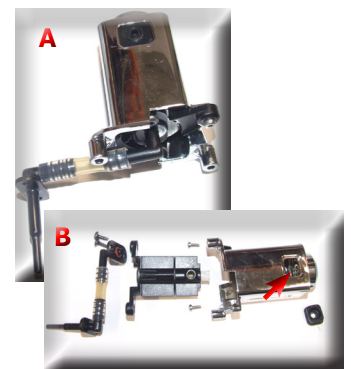

Remove the dispenser (picture B) making sure to reposition the highlighted spring correctly

7.14 Steam pipe assembly

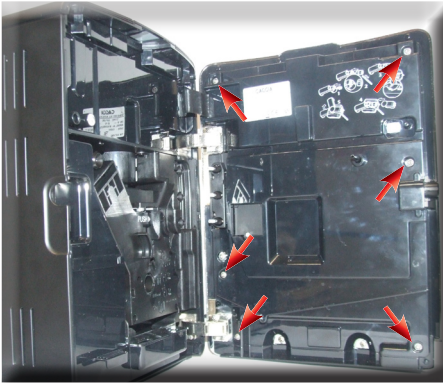

Loosen the screws as shown to remove the inner cover of the front panel

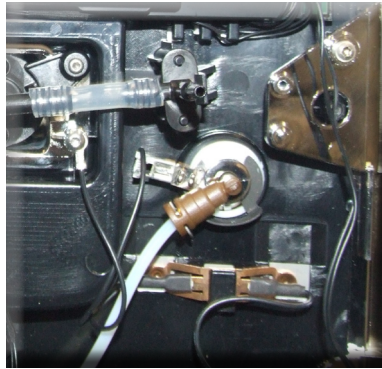

Remove the fork spring and the steam pipe washer and disconnect the pipe from the Teflon by removing the fork



7.15. Teflon pipe support and carafe fitting assembly

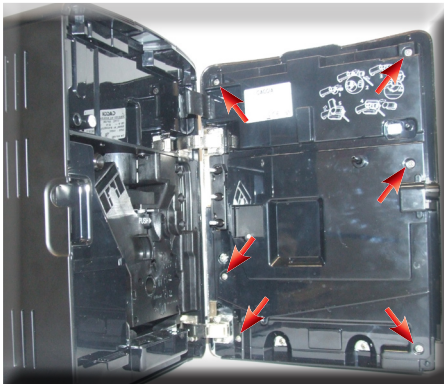

Loosen the screws as shown to remove the inner cover of the front panel

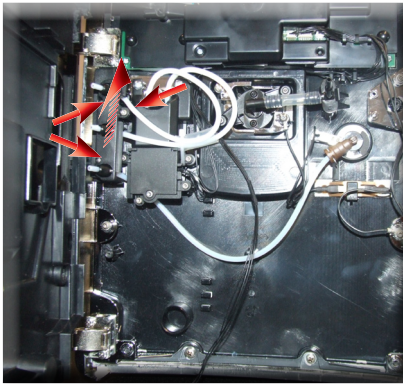

Loosen the screws as shown and the Teflon pipe support cover from the carafe

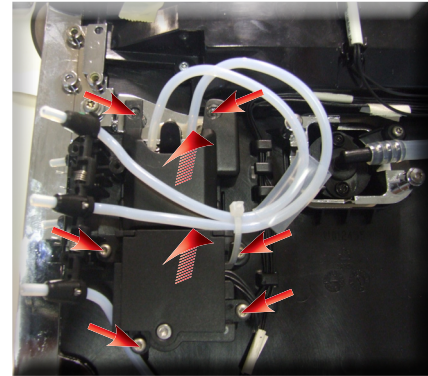

Loosen the screws shown and remove the front panel insert

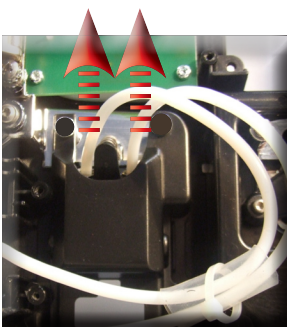

Remove the Teflon pipe support assembly

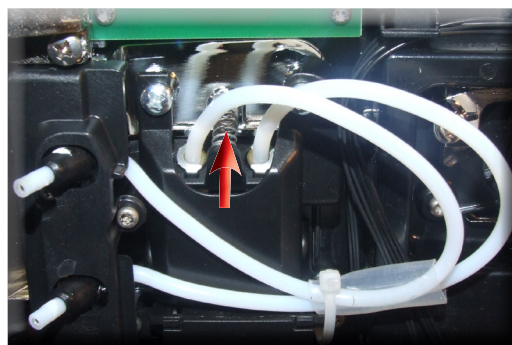

When re-mounting it, make sure to reposition the spring correctly

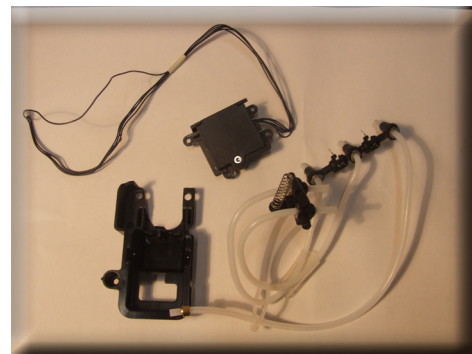

7.16 Carafe board general assembly

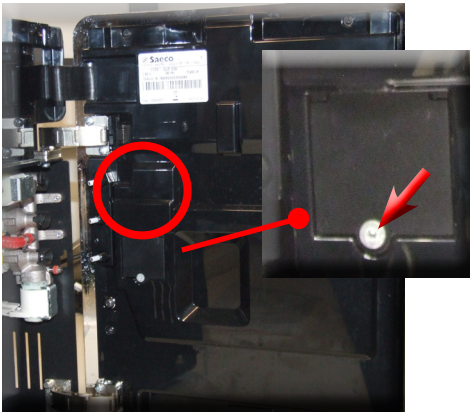

Loosen the screw as shown

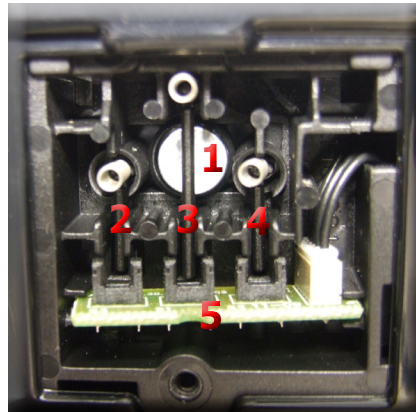

1) Magnet to improve carafe adherence to the door
2,3,4) Carafe presence and position sensors
5) Carafe board

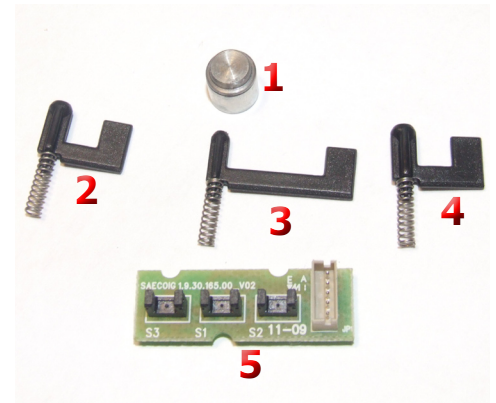

7.17 CPU board, display and front panel

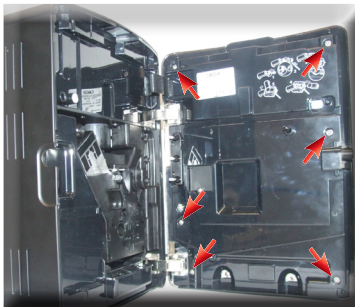

Loosen the screws as shown to remove the inner cover of the front panel

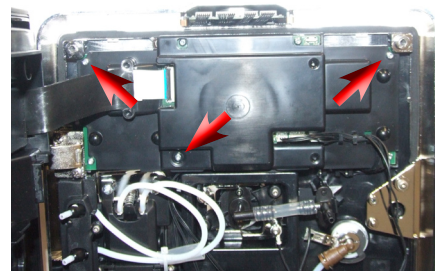

Loosen the screws as shown and remove the CPU board

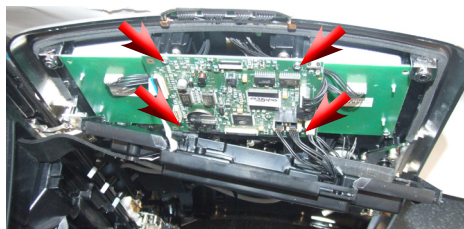

Remove the connections, loosen the screws as shown and remove the CPU board

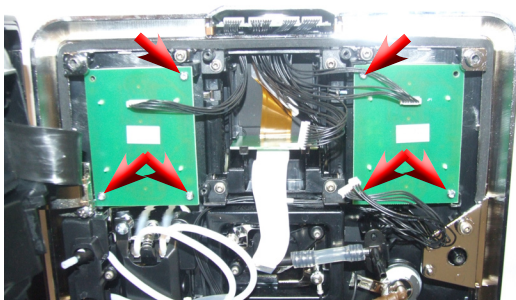

Remove the connections, loosen the screws as shown and remove the board KBD keyboard

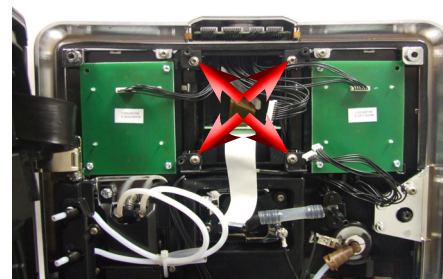

Remove the connections, loosen the screws as shown and remove the front panel

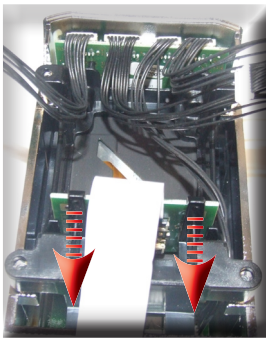

Remove the Display board by unhooking it from the support

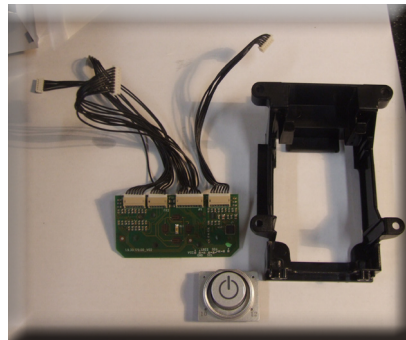
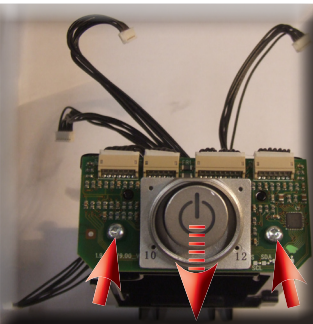

Loosen the screws as shown to remove the KBD STAND-BY board



Loosen the screws as shown to remove the KBD MENU board

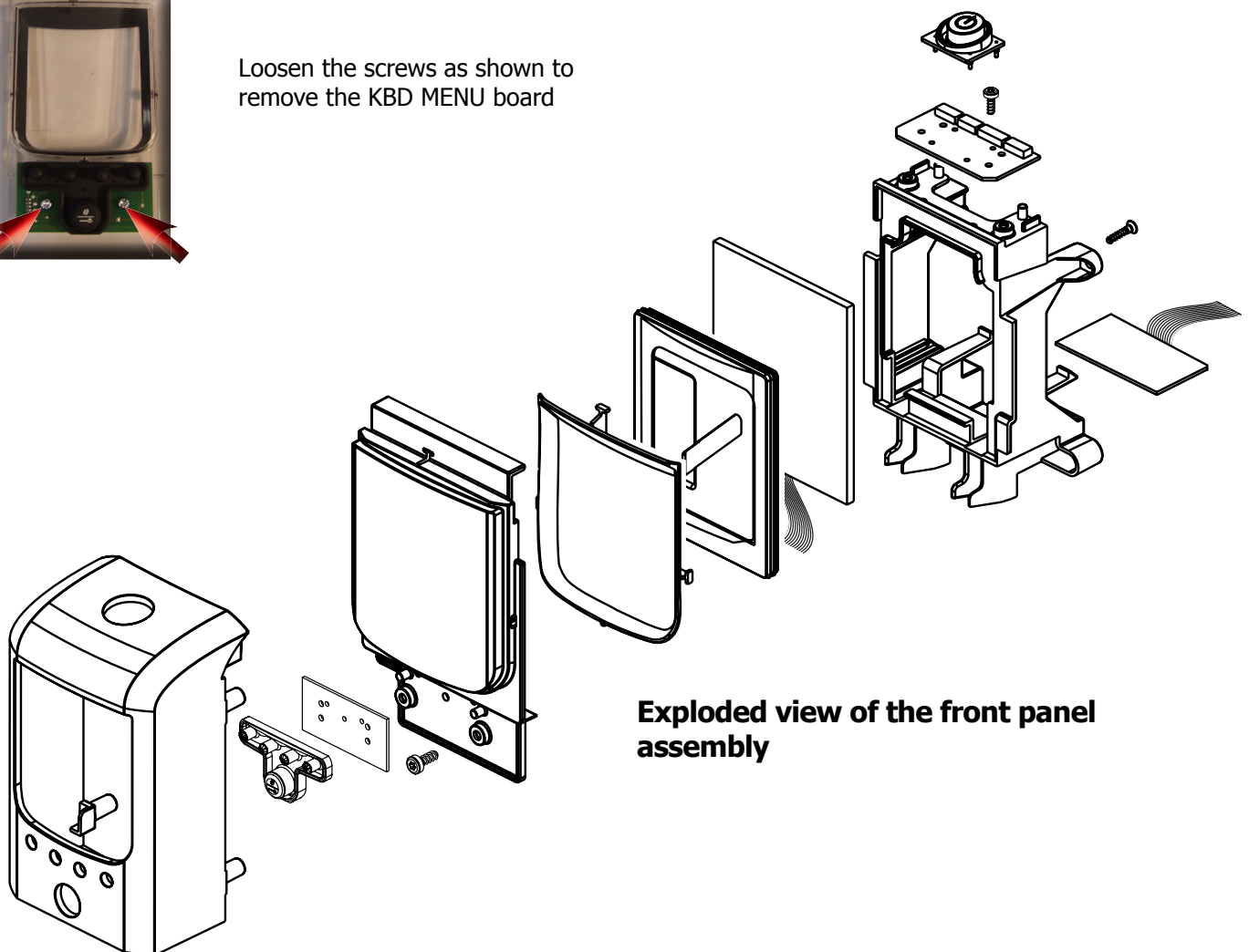

Exploded view of the front panel assembly

7.18. Un/installing Oetiker clamps

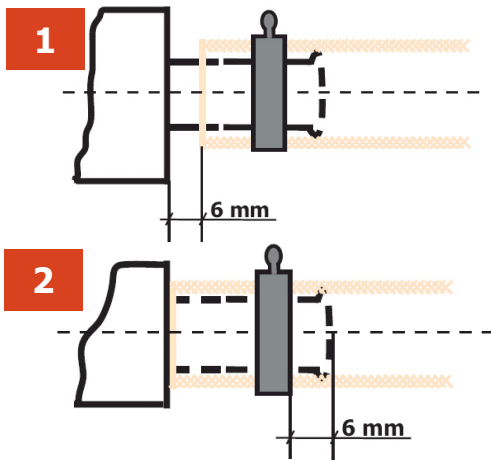

1) Boiler connection

2) Other connections



Replacing the pipes

1) Use a suitable pair of pliers to remove the clamp (as shown in the picture)



2) Tighten the clamp as shown in the pictures

CHAPTER 8

NOTES

CHAPTER 9

WATER CIRCUIT DIAGRAM

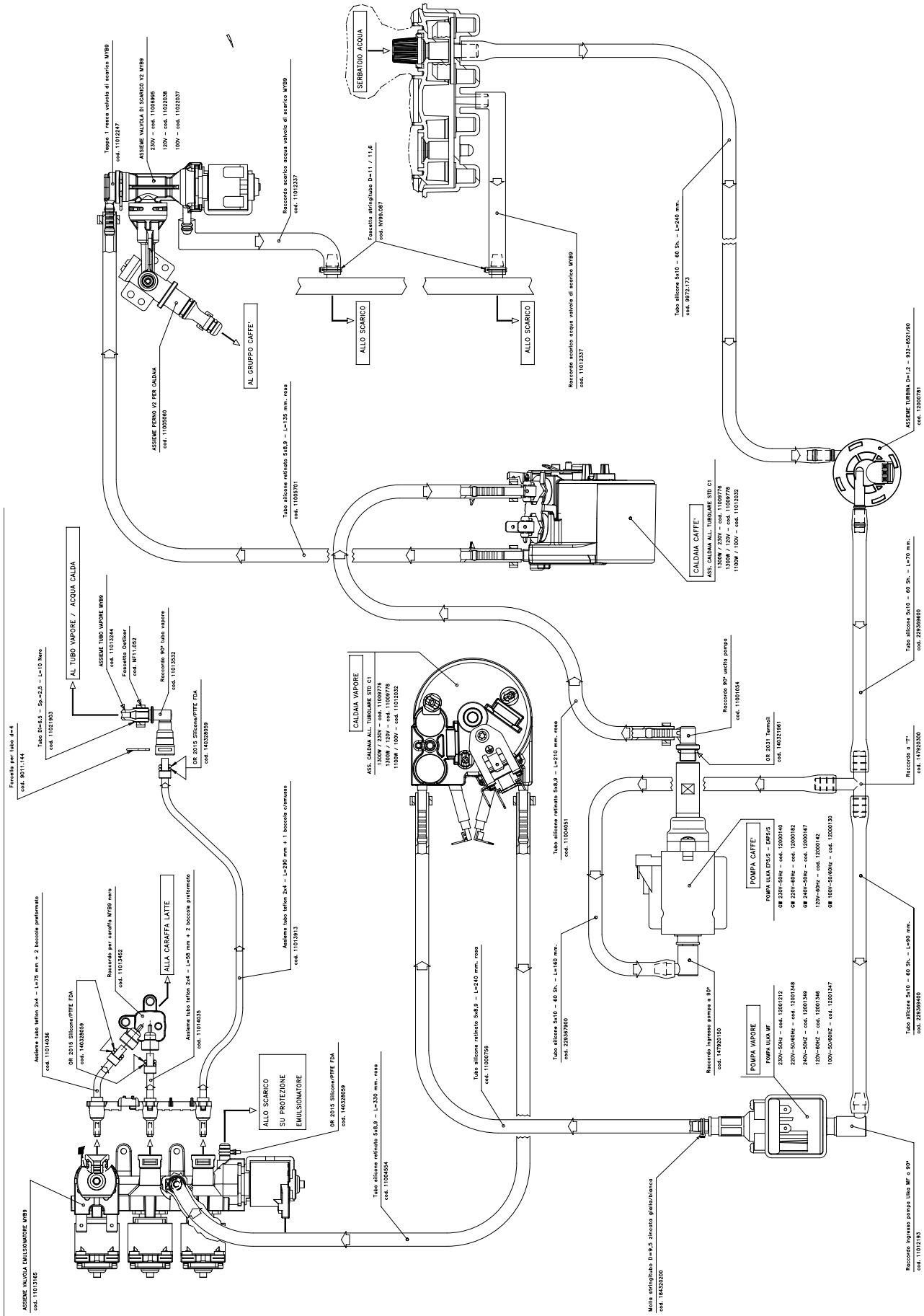

CHAPTER 10

ELECTRICAL DIAGRAM

