

GAGGIA[®] *Prera*



SERVICE MANUAL

Revision 00

All rights reserved. This document and all the information herein is provided without liability deriving from any errors or omissions. Furthermore, no part may be reproduced, used or collected, except where express authorisation has been provided in writing or through a contractual agreement.

Table of contents

	Page
1. Introduction	
1.1 Documentation required	1
1.2 Tools and equipment required	1
1.3 Material	1
1.4 Safety warnings	1
1.5 Brera range	2
1.6.1 External machine parts	3
1.6.2 Internal machine parts	4
2. Technical specifications	
2.1 Technical specifications	1
2.2 Machine parameters and performance	1
3. Brief instructions	
3.1 Customer and programming menu	1
3.2 Operation, cleaning and maintenance	3
4. Operating logic	
4.1. Water circuit	1
4.2 Control ringnut and valve	2
4.3 Coffee cycle operating diagram	3
4.4 Single microswitch	4
4.5 Temperature sensor	4
4.6 Coffee grinder operation	5
4.7 Detection of low bean level, dose adjustment, coffee grinder blockage	5
4.8 Dose self-learning	6

Table of contents

	Page
5. Service mode	
5.1. Test mode	1
6. Servicing & Maintenance	
6.1 Repair schedule	1
6.2 Service schedule	1
6.3 Final test	2
7. Disassembly	
7.1 Outer elements disassembly	1
7.2 Dispensing spout disassembly	1
7.3 Keypad card and valve card disassembly	2
7.4 Power/CPU card disassembly	3
7.5 Gearmotor disassembly	3
7.6 Boiler disassembly	4
7.7 Valve disassembly	4
7.8 Pump and turbine disassembly	5
7.9 OETIKER clamps assembly and disassembly	6
7.10 Coffee grinder disassembly	7
7.11 Grinder adjustment / assembly and disassembly	8
8. Notes	
9. Water circuit diagram	
9.1. Water circuit diagram	
10. Electrical diagram	
10.1 Wiring diagram	

1.1 Documentation required

The following documentation is needed for repair procedures:

- Instruction booklet for specific model
- Technical documentation for specific model (diagrams, exploded drawings)

1.2 Tools and equipment required

As well as the standard equipment, the following is required:

Qty.	Description	Notes
1	Screwdriver	Torx T 10
1	Pliers for Oetiker clamps	
1	CC -A - Vdc tester	
1	Digital thermometer	Scale limit > 150°C
1	SSC (Saeco Service Center)	Programmer

1.3 Material

Description	Notes
Thermal paste	Heating element > 200°C
Descaler	Saeco Entkalker
Grease solvent	Personal preference
Silicone grease	Safe to use with food

1.4 Safety warnings

We recommend you consult the technical manual of the machine before performing any maintenance work.

Observe all applicable standards relating to the repair of electrical appliances.

Always disconnect the power plug from the mains before beginning repair work.

Simply turning off the main machine power switch is not an adequate safety precaution.

This domestic appliance is rated as insulation class I.

On completion of the repair work, insulation and dielectric rigidity tests must be performed.

1.5. Brera range



Led interface	X
Painted details	X
Water/steam valve	X
Alarm LED	X
Automatic rinse	X
Automatic dosage	X
Pannarello (frother)	X
Dispensed coffee memory capacity	X
Automatic shutdown (after 60' inactivity)	X

1.6.1 External machine parts

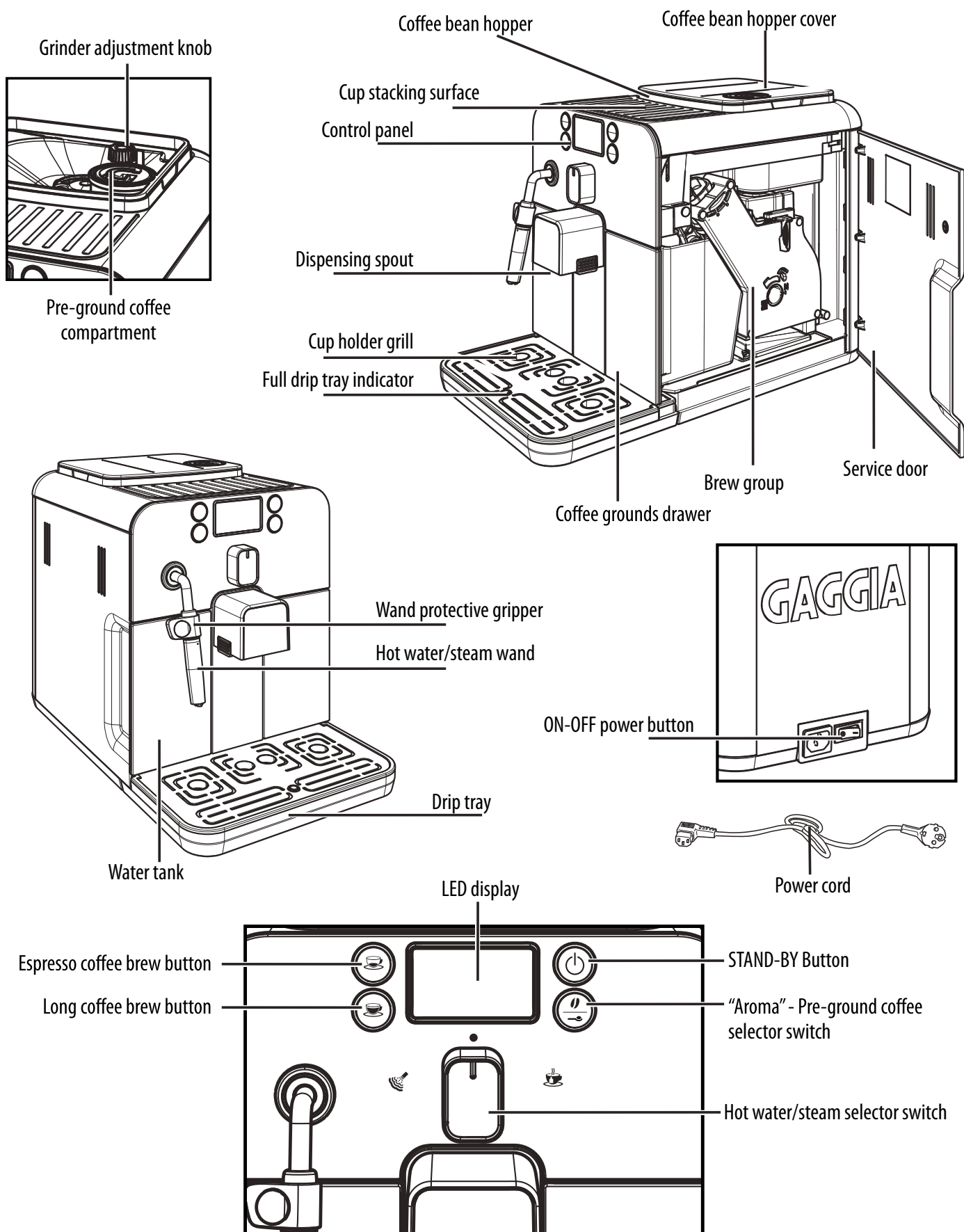

1.6.2 Internal machine parts

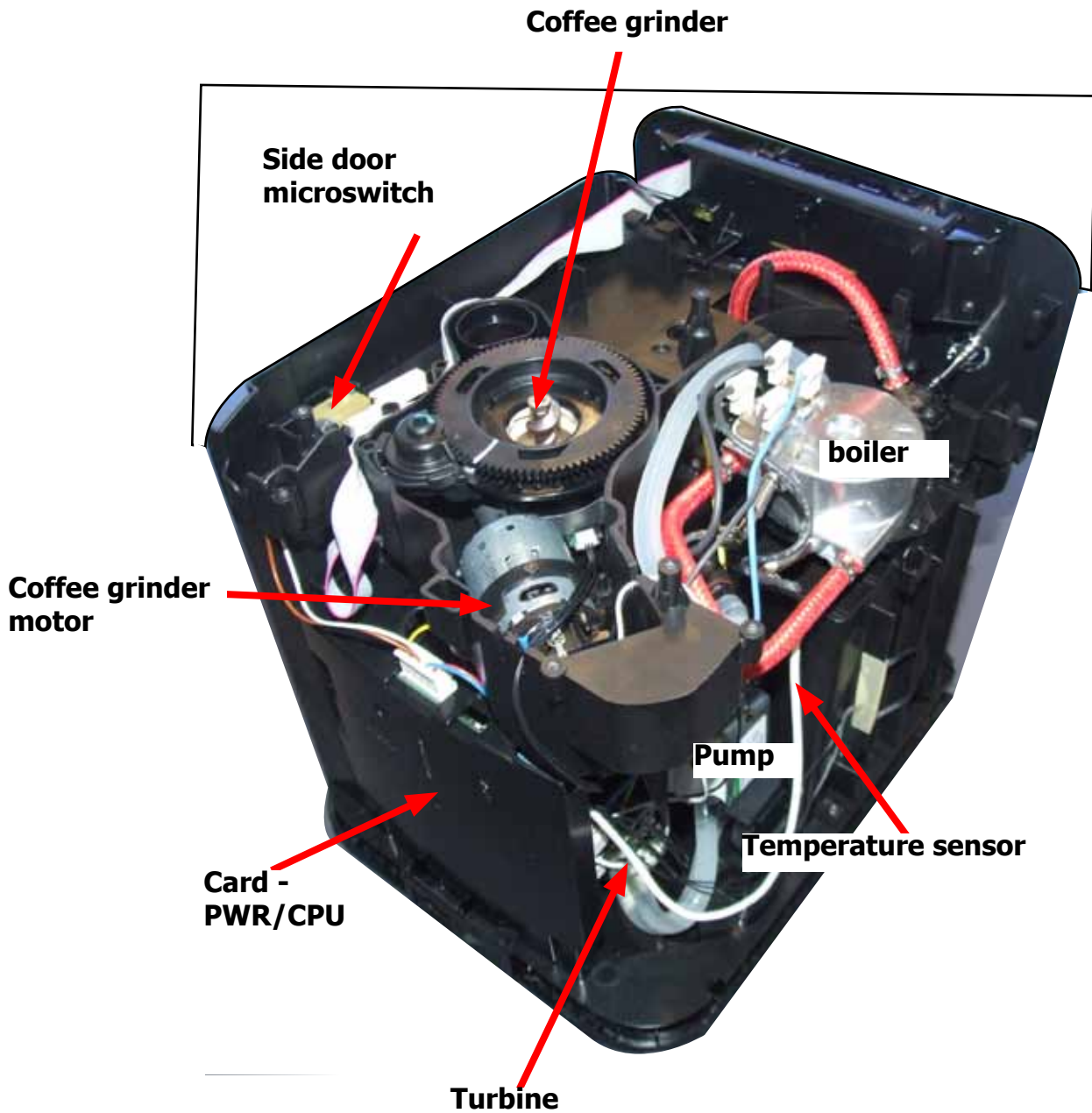

CHAPTER 2

TECHNICAL SPECIFICATIONS

2.1. Technical specifications

Power supply and output:	240 V~ 50 Hz 1400 W - 230 V~ 50/60 Hz 1400 W - 120 V~ 60 Hz 1500 W - 100 V~ 50/60 Hz 1300 W
Temperature monitoring:	Variable heating element sensor (NTC) - transmits the value to the electronic card
Safety system:	2 manual reset or one-shot thermostats (175°C)
Coffee heat exchanger output: Stainless steel	(230/120 V~) 1300 W - (100 V~) 1100W for coffee, hot water and steam dispensing
Gearmotor:	33VC with 2 rotation directions; power supply 24VC
Pump:	Ulka with reciprocating piston and 120°C cutout 48 W, 230V, 50 Hz, Type EP5 approx. 13-15 bar 120V, 60Hz 100V, 50/60 Hz
Overpressure valve:	Opens at approx. 16-18 bar
Water filter:	In tank
Coffee grinder:	Direct current motor with flat ceramic grinder blades
Hot water/steam valve	Presblock
Automatic dosage	Dose adjustment controlled by the electronic system
Power consumption:	During the heating phase - approx. 5,6 A
Dimensions: W x H x D in mm:	256x315x410
Weight:	9 kg
Water tank capacity:	1l.
Coffee bean hopper capacity	200 gr. coffee beans
Dreg drawer capacity	8
Heat exchanger capacity:	Approx. 10 cc
Water circuit filling time:	Approx. 15 seconds for first filling cycle
Heating time:	Approx. 45 seconds
Dispensing temperature:	Approx. 84°± 4°
Grinding time:	Approx. 8-10 seconds

2.2. Machine parameters and performance

AMOUNT OF PRODUCT	Minimum amount (Puls.)	Default amount (Puls.)	Maximum amount (Puls.)	Programm. by the user	Programm. by Production/Service department
Espresso	70	165	600	Yes	No
Medium coffee	No	No	No	No	No
Long coffee	70	440	600	Yes	No
Pre-ground	Yes				
Hot water	Continues until the water supply has been exhausted (capacitive sensor)				
Steam pannarello (frother)	Continues until the water supply has been exhausted (capacitive sensor)				

RINSE	Initial rinse	Final rinse
When performed	When the machine is switched on and the boiler temperature is $\leq 50^{\circ}\text{C}$	When the machine is switched off electronically, manually or automatically after 60', after having dispensed at least one coffee, before switching off
No. of pulses	180	80
Stopping option	Yes, by pressing any key	Yes, by pressing any key
User disable option	No	No
Disabling by Production/Service department	No	No
No. of pulses user adjustment option	No	No
No. of pulses adjustable by Production/Service department	No	No
Pulse range (Min. - Max.)	No	No

WATER HARDNESS
CANNOT BE SET

DREG DRAWER	Description and values
Time-out for dreg drawer	5 sec.
Empty dreg drawer alarm after (double coffee is the last product dispensed)	8 lots of dregs (9 lots of dregs)
Warning to empty dreg drawer after	No
Reset dreg counter	Every time the dreg drawer is removed for at least 5 seconds, even if the "empty dregs" alarm has not been activated

POWER/OFF	Description and values
Inlet time (min. - max.)	60 minutes
Inlet time (default)	No
Inlet time prog. by the user	No
Inlet time prog. by Production / Service departments	No





WATER TANK	Description
Level sensor	Yes
Water reserve (pulses) with water filter	200
Water reserve (pulses) with no water filter	200
Water reserve modifiable by Production/Service departments	No
"Fill tank" alarm	Yes
"No tray" alarm	No
Water mains	No







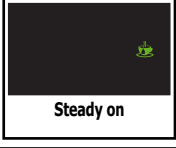
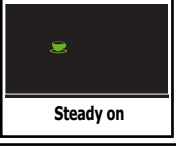
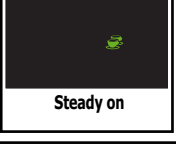
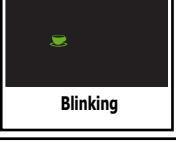



CHAPTER 3

BRIEF INSTRUCTIONS

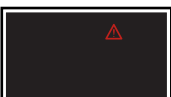
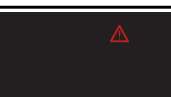
3.1. Customer and programming menu



Indications	Causes	Solutions
	Machine at correct temperature - for coffee bean dispensing - for hot water dispensing	Proceed with the dispensing process
	Machine at correct temperature - for ground coffee dispensing (pre-ground)	Proceed with the dispensing process
	Machine dispensing steam	Proceed with steam dispensing
	Machine dispensing hot water	Proceed with hot water dispensing
	Machine dispensing a coffee	Wait for the dispensing process to end (dispensing stops when you press the key again)
	Machine dispensing two coffees	Wait for the dispensing process to end (dispensing stops when you press the key again)
	The machine is being programmed with the coffee cup fill level	Stop dispensing as desired
	Machine in pre-heating phase for coffee, hot water and steam dispensing	Wait until heated (see bar)

Indications	Causes	Solutions
 <p>Cyclic blinking</p>	Machine in rinsing phase - wait for the machine to complete the procedure	Wait until end of procedure
 <p>Steady on</p>	The appliance requires a descaling cycle	Perform the descaling cycle To enter the descaling cycle press the aroma/pre-ground coffee key for 5 sec.
 <p>Steady on</p>	No coffee beans inside hopper	After filling the coffee bean hopper, start the cycle again
 <p>Steady on</p>	No water	Fill the water tank
 <p>Blinking</p>	Service door open: Close it If the service door is opened while product is being dispensed, the appliance stops dispensing and starts a 30 sec. countdown before cancelling the dispensing process. The countdown can be stopped by closing the service door and operation will resume from its stopping point.	
 <p>Blinking</p>	Turn the hot water/steam valve knob to the correct position. If the knob is turned (open) while product is being dispensed, the appliance stops dispensing and starts a 30 sec. countdown before cancelling the dispensing process. The countdown can be stopped by closing the knob and operation will resume from its stopping point.	
 <p>Blinking</p>	No brew group If the brew group is removed while product is being dispensed, the appliance stops dispensing and starts a 30 sec. countdown before cancelling the dispensing process. The countdown can be stopped by re-inserting the brew group and closing the service door; operation will resume from its stopping point.	
 <p>Steady on</p>	Refill circuit	Turn the knob to the cup 
 <p>Steady on</p>	Empty the dreg drawer	To reset the dreg counter, wait for the icon to flash (5 sec.)
 <p>Blinking</p>	Insert dreg drawer	When the dreg counter is reset, the icon flashes

3.2. Operation, cleaning and maintenance

Operating the machine		
1	Fill water tank	
2	Fill the coffee bean hopper	
3	Switch on the appliance	
4	Fill the circuit	Place a container under the steam wand and turn the selector to the "  " symbol and wait for the appliance to return to coffee ready status.
5	Press the coffee key	Press once for one coffee; twice for two coffees

CLEANING AND TECHNICAL SERVICING		
A	Empty the dreg drawer	When indicated or every three (3) months whichever occurs first
B	Empty the drip tray	As necessary
C	Clean the water tank	Weekly
D	Clean the coffee bean hopper	As necessary
E	Clean the casing	As necessary
F	Clean the brew group	Every time the coffee bean hopper is filled or weekly
	Lubricate the brew group	Once a month or every 500 dispensing procedures
	Clean the group housing	Weekly
H	Descaling	When indicated or every three (3) months, whichever occurs first

Descaling cycle frequency			
Hardness	Water hardness	Without water filter	With water filter
1	Soft water (up to 7°dH)	Approx. every 3 months / 120 litres	Approx. every 6 months / 240 litres
2	Medium water (7° - 14°dH)	Approx. every 2 months / 90 litres	Approx. every 4 months / 180 litres
3	Hard water (15° - 21°dH)	Approx. every 6 weeks or 60 litres	Approx. every 3 months / 120 litres
4	Very hard water (over 21°dH)	Approx. every 4 weeks or 30 litres	Approx. every 6 weeks or 60 litres

CHAPTER 4

OPERATING LOGIC

4.1. Water circuit

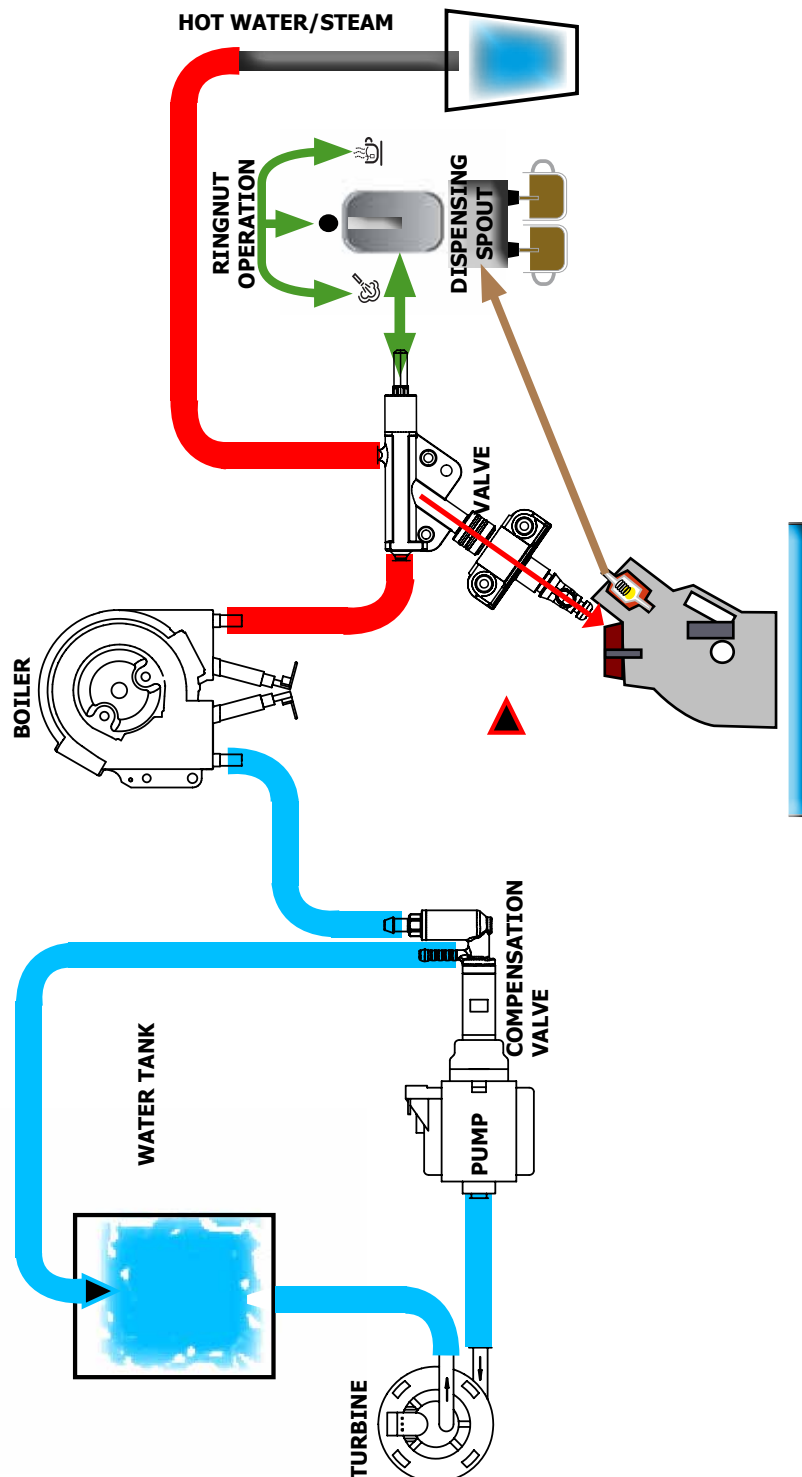

- Traditional water system
- Turbine - Amount of coffee dispensed into the cup
- Reciprocating piston type pump (13 - 15 bar)
- Compensation valve (opening pressure 16 - 18 bar)
- Boiler - 1400 W
- Presblok valve - select coffee - hot water - steam

4.2. Control ringnut and valve

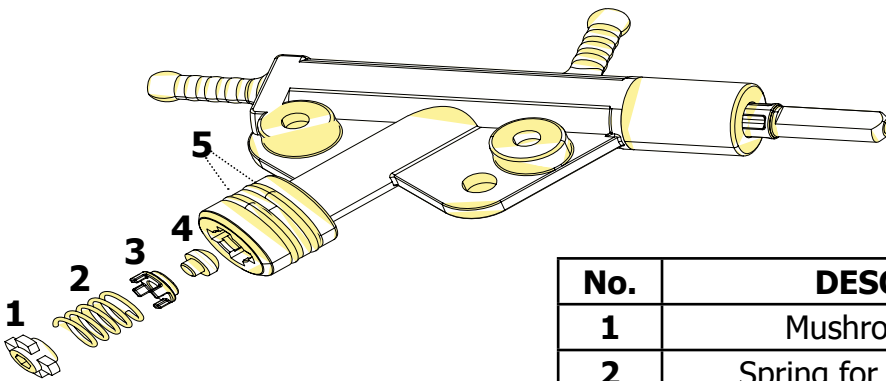

No.	DESCRIPTION
1	Mushroom valve cap
2	Spring for mushroom valve
3	Mushroom valve support
4	Mushroom valve
5	Sealing OR

When dispensing coffee the mushroom valve opens at 4 bar +/- 0.5

Manual opening when dispensing water

Manual opening when dispensing steam

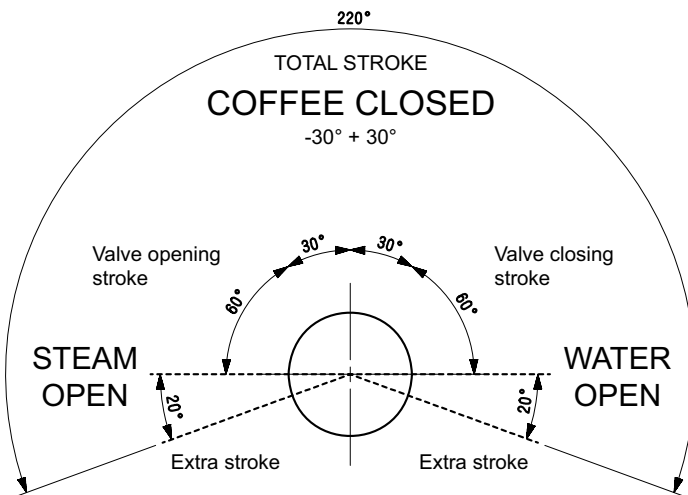
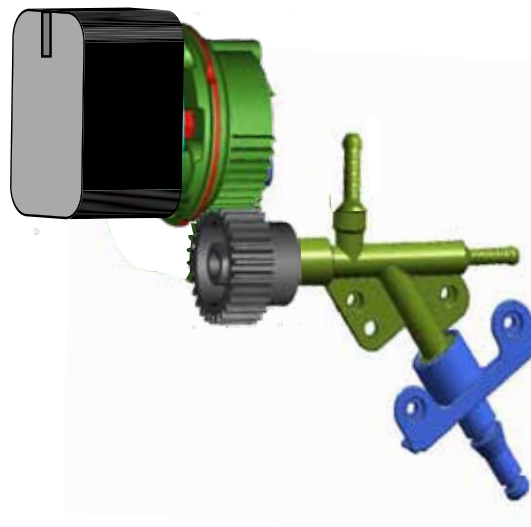

4.3. Coffee cycle operating diagram

Main switch ON	START		STOP
Time			
Coffee grinder			Pulses (Dosage)
Heating	approx. 45 sec.		
Pump			Pump activity (turbine pulses) depending on the product quantity selected *
Gearmotor Brew group			
Status	Heating	Ready	Coffee cycle

Notes: * Only with Prebrewing



Single microswitch gearmotor

Switching on

When the machine is switched on, the gearmotor repositions itself as follows:

- It acts on microswitch 1 (see following section)
- The gearmotor changes its rotation direction and moves upwards again by approx. 1-2 mm
- The boiler begins to heat water for approx. 45 seconds. It absorbs all the available heating power in order to reach the optimal temperature. The temperature will then remain at a constant level.

Coffee cycle

1. The coffee grinder starts the grinding process (controlled by pulses generated by a sensor)
2. The gearmotor (brew group) moves to the dispensing position
3. Preliminary dispensing phase (short pump activity, short pause)
4. Product dispensing (the pump operation period is defined by the amount of product dispensed)
5. The gearmotor moves to its home position (the dregs are expelled automatically).

4.4. Single microswitch

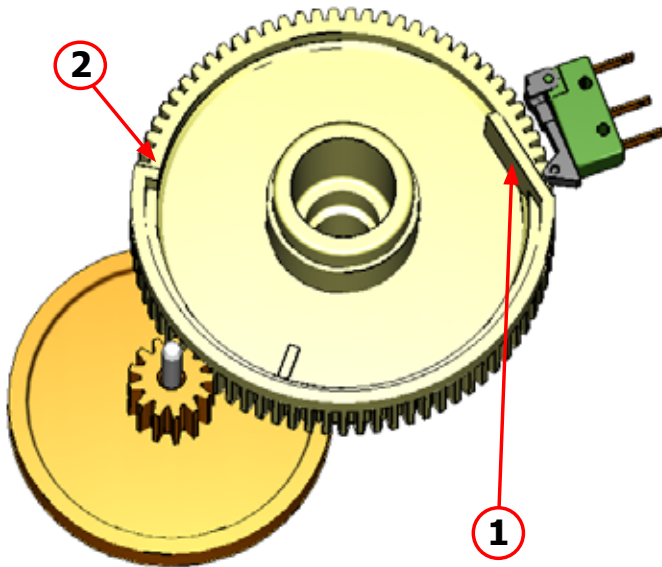

The gearmotor is powered by a direct current motor that engages with the smaller double toothed wheel using a worm screw. The brewing unit is mounted on the axle of the large gear wheel and when a coffee is requested, it moves from the standby position to the dispensing position, and then back to the standby position again.

- Standby position: 1

- Dispensing position: 2

4.5. Temperature sensor (adjustment)

Temperature sensor

An NTC is used as a temperature sensor; in the event of overheating this reduces boiler element power consumption.

The electronic system detects the current boiler temperature from the drop in voltage of the sensor and adjusts it accordingly.

Heating element values: see table

Temp. (°C)	R nom (kΩ)	ΔR (+/- %)
20	61,465	8,6
50	17,599	5,9
75	7,214	4,1
80	6,121	3,7
85	5,213	3,4
90	4,459	3,1
100	3,3	2,5
125	1,653	3,9
150	0,893	5,1

4.6. Coffee grinder operation

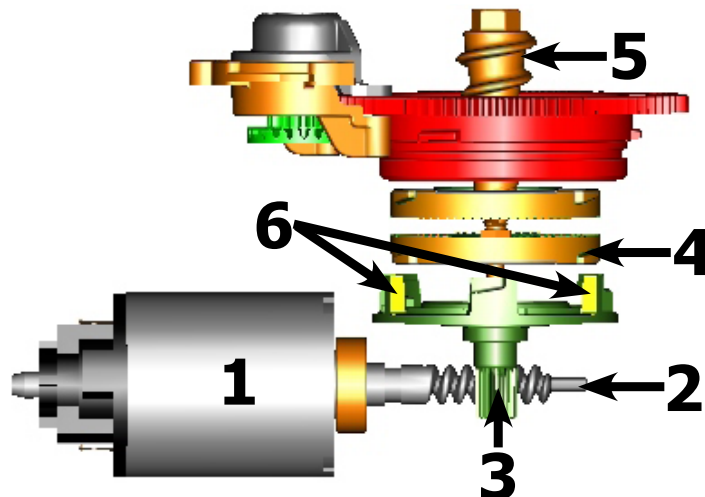

Ceramic coffee grinder

The coffee grinder is driven by a direct current motor (1) using a worm screw helicoidal wheel transmission (2).

The worm screw (2) drives a plastic gear wheel (3), which turns the lower grinder (4) and the increment pin (5).

There are two magnets (6) in the gear wheel; at every rotation these induce two pulses to a Hall sensor, which in turn transmits them to the electronic system.

4.7. Low bean level detection, dose quantity adjustment, coffee grinder blocked

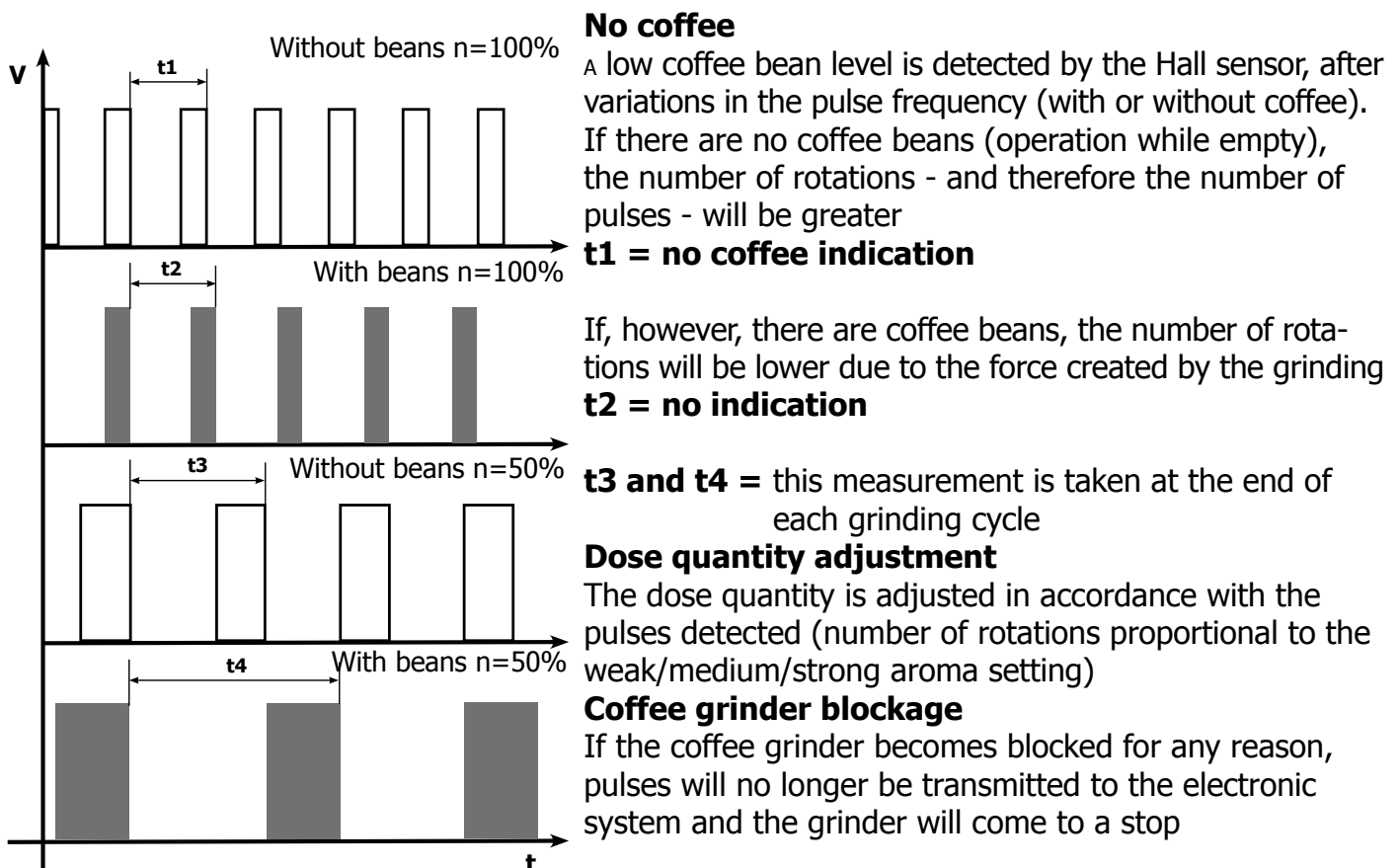

4.8 Dose self-learning

With an algorithm based on three pieces of information (listed below) detected by the machine computer, the average dose is adjusted automatically (SELF-LEARNING).

1. Number of coffee grinder pulses taking place during the grinding cycle
2. Max. average value of the power consumed by the gearmotor during the cycle for coffee brewing
3. Aroma selected by the user

The algorithm compares the maximum average value of the power consumed by the unit with the value listed in the table for the selected aroma, in order to calculate the new grinding pulse value for the next coffee produced.

If the value of the current absorbed by the gearmotor is lower than the value of the minimum current, the grinding pulses will be increased by 2.

If the value of the power consumed by the gearmotor is greater than the value of the maximum current, the grinding pulses will be decreased by 4.

If the "pre-ground" aroma is selected by the user, no modification will be made.

Min. current (mA)	Max. current (mA)	Aroma (pulses)
200	300	Mild (- 10% of the average value)
301	450	Average (nominal)
451	600	Strong (+ 10% of the average value)
–	–	pre-ground

If the gearmotor power consumption value falls within the "overwork" interval, the grinding pulses will be decreased by 10 and the product will be dispensed.

If the gearmotor power consumption value falls within the "expulsion" interval, the grinding pulses will be decreased by 10 and the pad will be dispensed.

Min. current (mA)	Max. current (mA)	Aroma (pulses)
800	1000	Overwork
1001	- -	Pad expulsion

CHAPTER 5

SERVICE MODE

5.1. Test mode

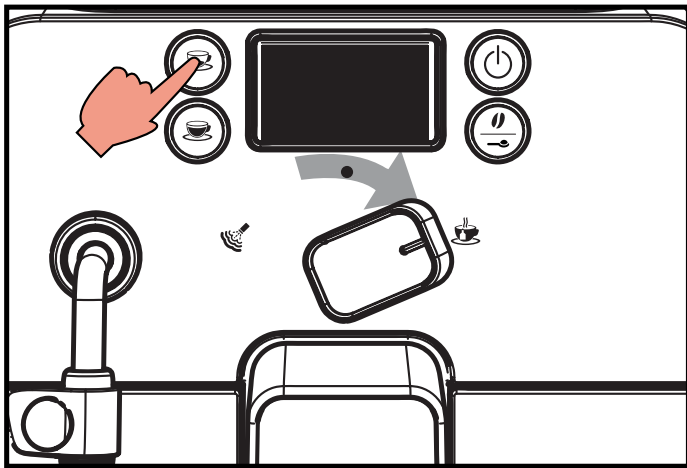

To enter Test Mode

1. place the control knob in the water position
2. keep the espresso coffee key pressed
3. switch the appliance on from the 0/I button located at the rear of it; the icons scroll through in sequence
4. release the espresso coffee key

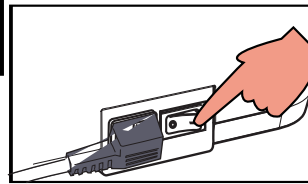









Operational check - keys

PRESS	No key			
SETTINGS				
PRESS THE ON/OFF KEY TO ACCESS THE NEXT LEVEL UP				







Operational check - microswitches and sensors

PRESS	Control knob in water pos.	Control knob in coffee pos.	Control knob in steam pos.	No water
SETTINGS				
PRESS	RHS service door open	No dreg drawer	No unit	
SETTINGS				
PRESS THE ON/OFF KEY TO ACCESS THE NEXT LEVEL UP				



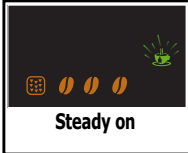
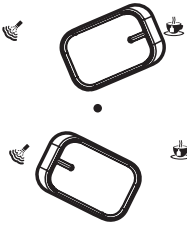

Brew group operational check

PRESS			NOTES
SETTINGS			Illumination of  icon When absorption is greater than 300 mA with the group inserted and 200 mA with the group not inserted.
FUNCTION	Group in work position (up) when the limit is reached, illumination of  In the event of a malfunction, illumination of 	Group in standby position (down) when the limit is reached, illumination of  In the event of a malfunction, illumination of 	
PRESS THE ON/OFF KEY TO ACCESS THE NEXT LEVEL UP			

Operational check - pump

PRESS			NOTES
SETTINGS			If the control knob is set to hot water or steam and the  key pressed, water is dispensed from the steam wand Return to the previous level, set the brew group to its work position (up), return to this level, set the control knob to coffee and press the  button ; water will be dispensed from the dispensing spout
FUNCTION	Pump operation (the turbine monitors the water flow and the  icon begins to flash)		
PRESS THE ON/OFF KEY TO ACCESS THE NEXT LEVEL UP			

Coffee grinder and boiler operational check

PRESS			NOTES
SETTINGS			Boiler: Connect the machine (closed) on a counter with ammeter and check its absorption level; if using an ammeter with needles, open the machine and connect the device to the boiler heating element
FUNCTION	Boiler operation. Increase absorption	Coffee grinder operation. The  icon flashes to confirm sensor operation	

CHAPTER 6

SERVICING AND MAINTENANCE

6.1. Repair schedule

	Action
1	Visual inspection (transport damage)
2	Machine data check (rating plate)
3	Operational check / problem analysis
4	Opening machine
5	Visual inspection
6	Operational tests
7	Repairing the faults encountered
8	Checking any modifications (view info, new sw, etc.)
9	Service activities in accordance with the operating schedule
10	Internal cleaning
11	Operational test while the appliance is open
12	Assembly
13	Final inspection test
14	Draining the circuit (in winter)
15	External cleaning
16	Lubricating the brew group with suitable grease
17	Insulation test HG 701 (dielectric)
18	Documentation

6.2. Service schedule

S Replacement

ES Visual inspection

D Descaling

P Cleaning

TR Noise test

R Adjustment

Component	Action	Support/tool
Water filter	P/S	
Water tank lip seal	S	
Boiler pin O-ring	S	
Brew group	ES/P	Grease solvent / Grease
Hoses, attachments and Oetiker clamps	ES	
Pump	ES/TR	
Gearmotor	ES/TR	
Coffee grinder	P/R	Vacuum cleaner / brush
Water circuit	D	Saeco descaler
Hot water/steam valve	ES/S	

6.3. Final test

Test	Procedure	Support/ tool	Standard	Tolerance
Espresso	2-3 Espressos for adjustment purposes	Measuring scoop	Same amount	15%
Coffee	2-3 Coffees for adjustment purposes	Measuring scoop	Same amount	15%
Noise			Standard	
Amount of cream	Blow into the cup until the cream separates		The cream should come together again to form a complete layer	
Cream colour			Hazel brown	
Temperature	Reading taken while dispensing	Thermometer	84 °C	± 4 °C
Grinding level	Check the grain size of the ground coffee			
Hot water	Dispense water			
Steam	Dispense steam			
Dreg drawer missing indication	Remove the dreg drawer		Dreg drawer missing indication	
Missing indication coffee beans	Start brewing a coffee while the coffee bean hopper is empty		Missing indication coffee beans	

CHAPTER 7

DISASSEMBLY

7.1. Outer elements disassembly



1

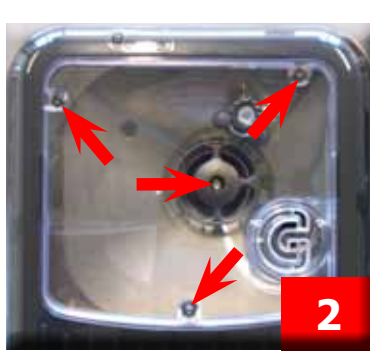

2

1) Remove the dreg drawer, water tank, coffee bean hopper cover, drip tray, brew group, steam wand cap and pannarello (frother)

2) Unscrew the screws shown and remove the finger protection device and coffee bean hopper



3



4

3) Lift and remove the top cover

4) Slide out the service door, lifting it upwards

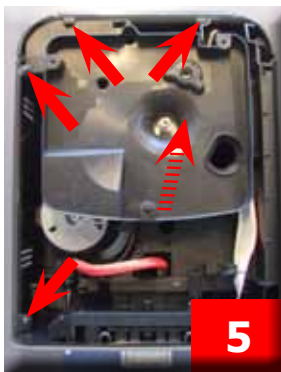

5



6

5/6) Unscrew the screws shown and slide out the rear cover, side cover and coffee grinder sound insulating cover

7.2. Dispensing spout disassembly



7



8

7) Slide out the control knob cover, unscrew the screws shown and slide out the dispensing head cover

8) Unscrew the screws shown and slide out the dispensing head fixed support

9) Slide out the front panel support by lifting it

10) Remove the fork



9



10

7.3. Keypad card and valve card disassembly

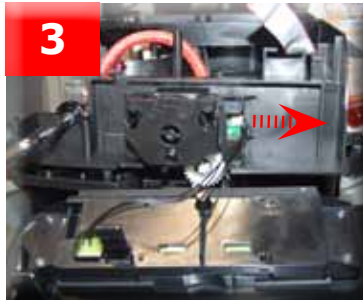

1) Unscrew the screws shown

2) Release the stop device and the flat cable Slide out the front panel

3) Disconnect the connector shown and unscrew the CPU card support screws shown

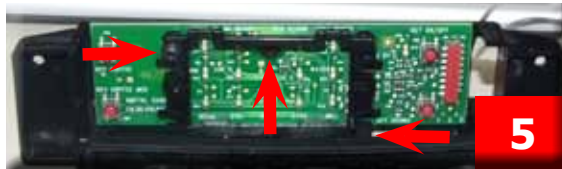

4 / 5) Unscrew the screws shown



7) Slide out the keys, seal, light guide and LED glass

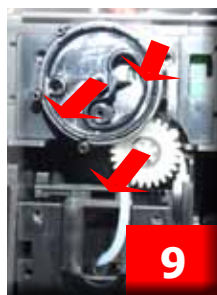
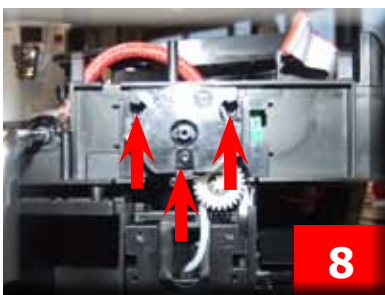

8) Unscrew the screws shown

9) Slide out the top cover, knob support assembly, gear and card support



10) Release the card from the support

7.4. Power/CPU card disassembly

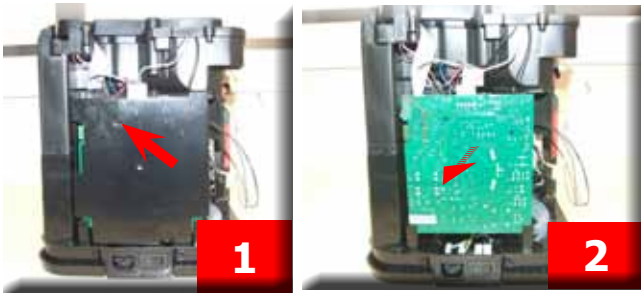

- 1) Unscrew the screw shown and remove the card protection
- 2) Slide out the card, removing all connections

7.5. Gearmotor disassembly

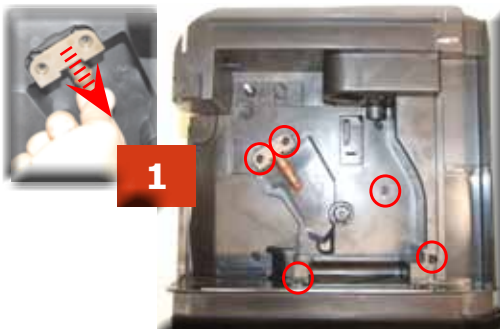

- 1) Unscrew the screws holding the boiler pin in place, remove them and unscrew the other screws shown

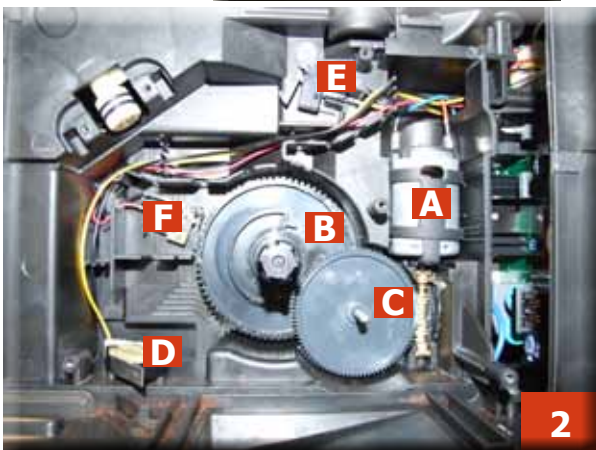

- 2) The following are located inside the compartment protected by the casing:
 - Brew drive (A) with gears (B) and (C) for transmission and timing of the dispensing head.
 - Dreg drawer present microswitch (D)
 - Dispensing head present microswitch (E)
 - Microswitch (F) intercepting both the standby phase of the dispensing head and the dispensing phase
- Slide out the gear (C) that meshes with the brew drive
- Remove the large gear (B)
- Remove the brew drive (A), complete with transmission shaft

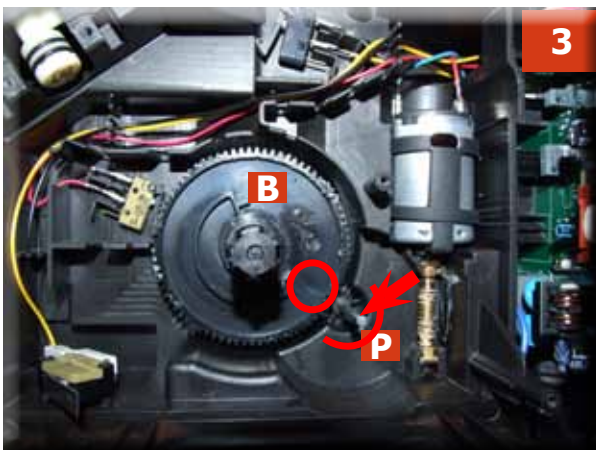

- 3) Replace the gear (B), making sure that the imprint of the arrow is aligned with the opening containing the pin (P).



- 4) When replacing the brew drive and the transmission shaft, make sure the bearings (L) are in the right position.
Grease the shaft thoroughly and evenly

7.6. Boiler disassembly

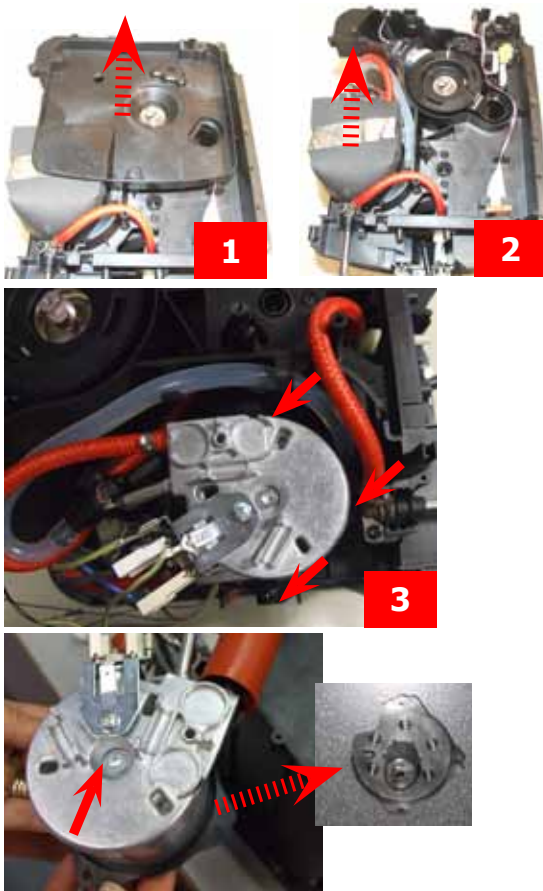

1) Remove the coffee grinder sound insulating cover

2) Remove the boiler insulation

3) Unscrew the screws shown.

4) Unscrew the screw and remove the plastic support.
Disconnect the hoses and the connections

7.7. Valve disassembly

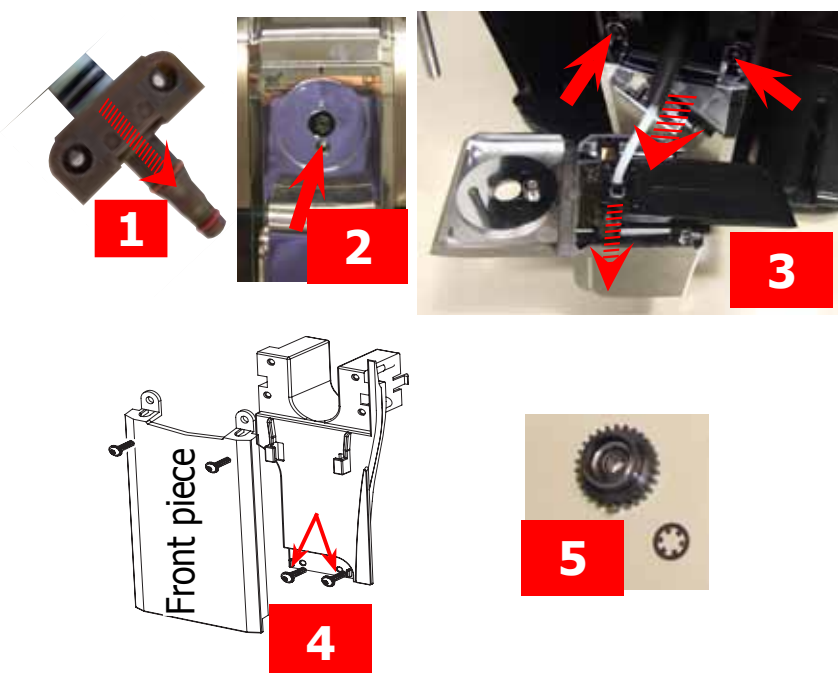

1) Remove the boiler pin

2) Remove the control knob cover and unscrew the screw as indicated

3) Lift and remove the dispenser assembly, slide out the fork shown and unscrew the screws holding the front piece

4) Unscrew the screws shown to remove the front piece support.

5) Remove the spring washer and the control knob gear (steam/water)



6) Unscrew the screws shown to remove the insert on the base of the casing

7) Unscrew the screws shown and disconnect the valve from the water connections.

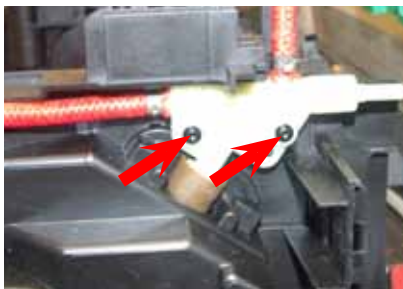

7) Unscrew the screws shown and disconnect the valve from the mesh hoses

7.8. Pump and turbine disassembly



PUMP

Remove the connection **1**, disconnect the silicone hoses **2**

Unscrew the safety valve and remove the pump from the two supports

TURBINE

Remove the connection and disconnect the silicone hoses

7.9. Disassembling and fitting OETIKER clamps

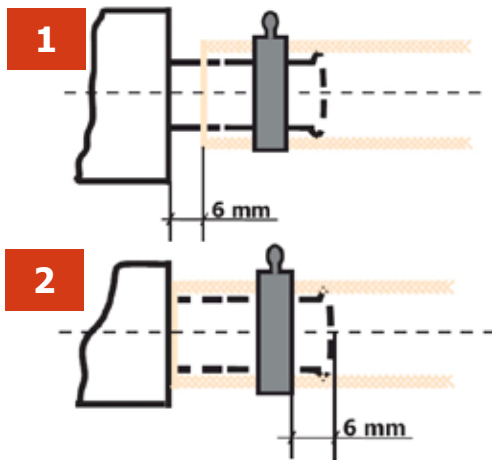

1) Boiler connection

2) Other connections



Replacing the hoses

1) Use a suitable pair of pliers to remove the clamp (as illustrated)



2) Tighten the clamp as illustrated

7.10. Coffee grinder disassembly



1) To remove the coffee grinder, simply slide it out and remove its connections

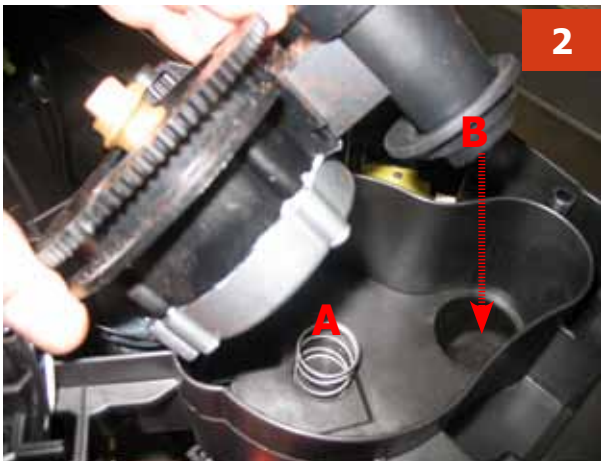

2) When replacing it, make sure the spring (A) and the coffee pipe (B) are positioned correctly

7.11. Grinder adjustment / assembly and disassembly



1

1) To remove the upper grinder support, using a hex key push down and turn clockwise to release the grinder support from the bayonet coupling



2

2) To remove the grinder blade from the upper support, turn it anti-clockwise until it detaches from the bayonet coupling



3

3) To remove the lower grinder blade, keep the increment pin (A) locked in position and turn the grinder blade anti-clockwise, until it detaches from the bayonet coupling

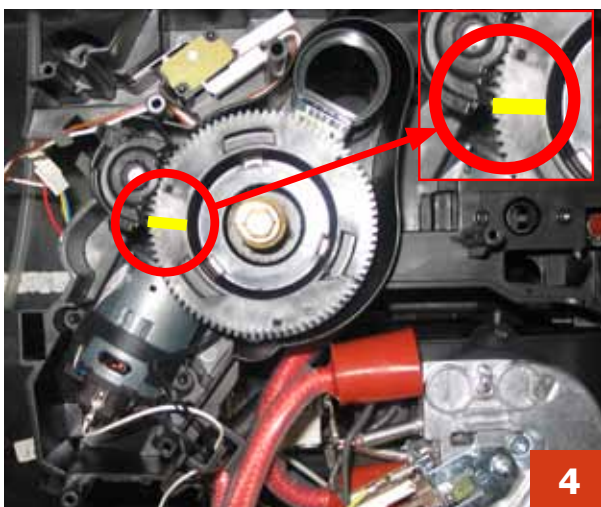

4

4) When refitting the upper grinder support, make sure you reposition it so that the mark is as illustrated in the photo

CHAPTER 8

NOTES

CHAPTER 9

WATER CIRCUIT DIAGRAM

9.1. Water circuit diagram

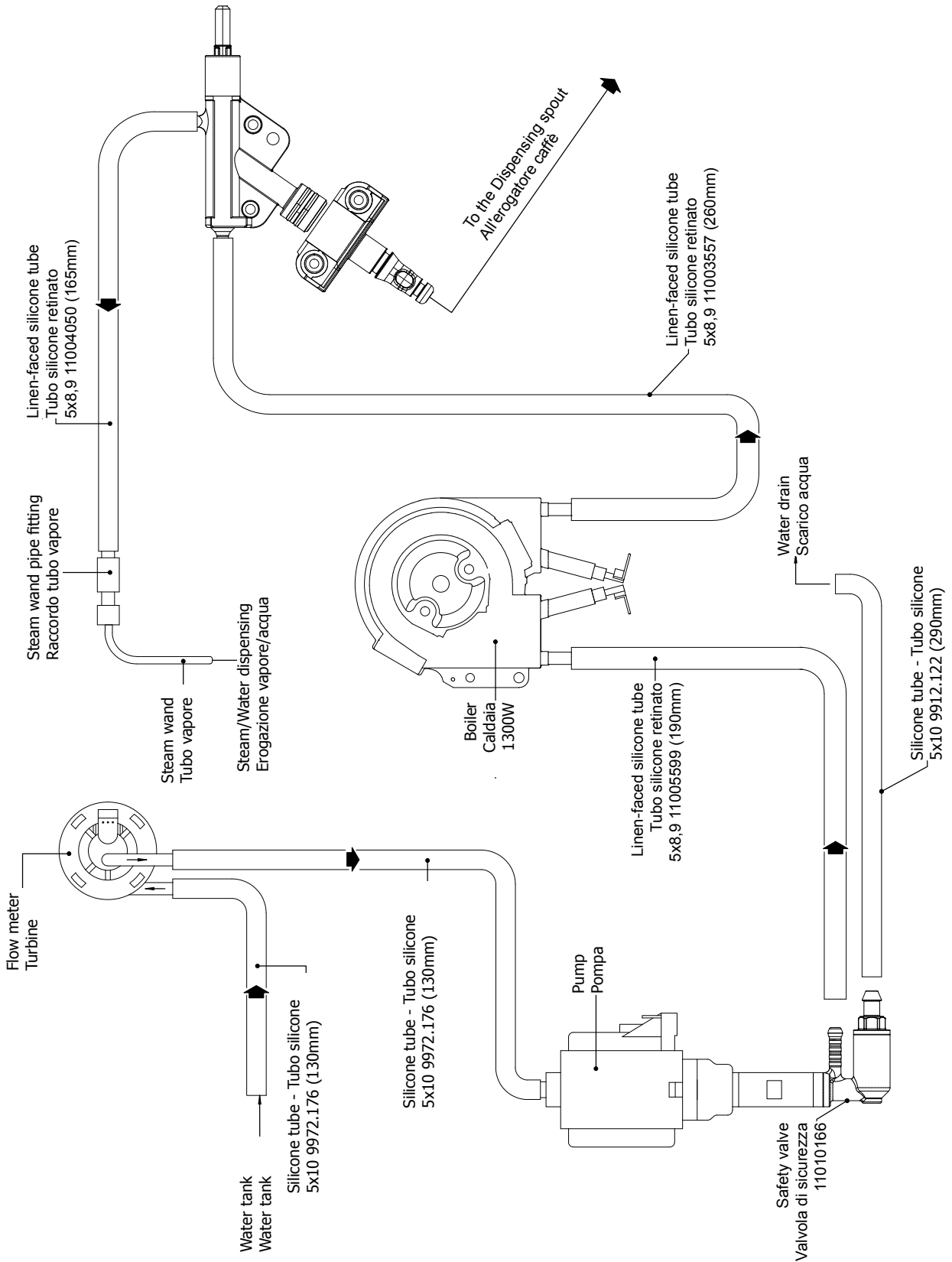

CHAPTER 10

ELECTRICAL DIAGRAM

10.1 Wiring diagram

