

**ROYAL CLASSIC
ROYAL EXCLUSIV
ROYAL DIGITAL
ROYAL DIGITAL REDESIGN
ROYAL DIGITAL PLUS
ROYAL PROFESSIONAL
ROYAL PROFESSIONAL REDESIGN
ROYAL CAPPUCCINO
ROYAL CAPPUCCINO REDESIGN
ROYAL COFFEEBAR
ROYAL OFFICE**

SERVICE MANUAL

Revision 4

Saeco

Saeco International Group

SEPT.: 2003

All parts of the present service manual are the property of Saeco International Group. All rights reserved. The manufacturer is not responsible for any errors or omissions in the present document. Any reproduction or unauthorised use of this manual without the prior written permission of the manufacturer or by contractual agreement is prohibited.

Table of contents

- 1. Introduction**
- 2. Technical data**
- 3. Operation**
- 4. Functions and timing**
- 5. Service programme**
- 6. Faults**
- 7. Fault diagnosis**
- 8. Repairs / Service schedule**
- 9. Disassembly**
- 10. Circuit diagrams**

CHAPTER 1

INTRODUCTION

	Page
1. Documents required	1
2. Equipment	1
3. Material	1
4. Safety instructions	1
5. Overview of product range	2

1. Documents required

The following documents and requirements are necessary to qualify for an authorised repair.

- Service manual
- Operating instructions where available

2. Tools

In addition to an electrical workshop, the following standard tools are necessary:

	Description	Comments
1	Special screwdriver (Pozi)	Size: PZ1
1	Special screwdriver (Pozi)	Size: PZ2
1	Special screwdriver (Torx)	Size: T10
1	Temperature measuring device	Temperature range > 150°C Suitable for point measurements

3. Material

Description	Comments	Brand
Heat conductive paste	Temperature resistance $\geq 200^{\circ}$	User's choice
Bolt adhesive	Temperature resistance $\geq 200^{\circ}$	User's choice
Descaler		Saeco
Grease solvent		User's choice
Silicone grease (food safe)		Saeco

4. Safety instructions

All prescriptions and regulations in force regarding the repair of electrical equipment must be observed!

The machine must be disconnected from the main power supply before performing repair work. Switching the machine off is not an adequate measure.

The Royal coffee machine is classified under Protection Class 1. Protective devices must be tested once the repair work has been completed.

5. Overview of product range



Royal Redesign



Royal

TYPE	Pre-grinding/ brewing	Cappuccino maker	Steam system	Second pump	Second heating system	Display
Classic *	Pre- brewing					Dial control
Exclusive	x					x
Digital	x					x
Digital Redesign	x					x
Digital Plus	x		Rapid Steam		Pipe heater	x
Professional (Instant Steam)	x	x	Instant Steam	x	Flow heater	x
Professional (Rapid Steam)	x	x	Rapid Steam		Pipe heater	x
Professional Redesign	x	x	Rapid Steam		Pipe heater	x
Cappuccino	x	x	Instant Steam	x	Flow heater	x
Cappuccino Redesign	x	x	Instant Steam	x	Pipe heater	x
Coffeebar **	x	x	Rapid Steam		Pipe heater	x
Office***	x					x

Note:

* All machines, with the exception of the Royal Classic, are fitted with a powder coffee feed.

** The Royal Coffeebar has a fixed water connection (reversible).

***Royal Office – no steam function.

Output capacity:

Royal Series (Household): Maximum average daily output: 30 coffees

Royal Office / Coffeebar: Maximum average daily output: 50 coffees

CHAPTER 2

TECHNICAL DATA

	Page
1. Technical Data Royal (Classic)	1
2. Technical Data Royal (Digital/Digital Redesign/Exclusive)	2
3. Technical Data Royal (Cappuccino/Professional Instant Steam/ Cappuccino Redesign)	3
4. Technical Data Royal (Professional-Rapid Steam/Prof. Redes. Digital Plus/Coffeebar)	4
5. Technical Data Royal (Office)	5

1. Technical data (Royal Classic)

Royal Classic	
Technical data	
Power supply/output:	230V 50Hz 1250W
Safety system:	170°C Safety thermostat for instantaneous water heater
Temperature monitoring:	KTY Temperature sensors transmit respective temperatures to electronic system
Continuous flow thermoblock:	Instantaneous water heater (1090 W) for coffee and hot water dispensing
Pump:	Ulka reciprocating piston pump with angle connector and thermostat - 48 W, 230V, 50 Hz. Type EX5, 20 l/h
Safety valve:	Conventional safety valve connected to pump
Water filter:	Installed in machine in front of the turbine and pump.
Gearmotor:	Direct current, 30 - 35 V
Cup warmer/gear resistor:	Approx. 437W / 130Ω (only activated when gears are operational)
Grinder (conical grinder):	Plastic grinding screw, galvanised steel grinding cone and grinding disc
Motor:	260 V Direct current
Second doser:	230 V - Magnet coil
Power consumption:	During heating - approx. 4.5 A Standby - Approx. 0.04 A
Pump pressure:	Max. 15 bar
Dimensions W x D x H in mm:	330/385/395
Weight:	Approx. 15 kg
Capacity of coffee bean container:	Approx. 300g
Capacity of water tank:	Approx. 2.4 l max. filling volume
Instantaneous water heater capacity:	Approx. 1.0 ccm, 10 ml volume
De-aeration time:	Approx. 1 - 2 sec. for initial star-up
Heating time:	Approx. 80 sec. with water at 10°C to operating temperature
Re-heating time:	None due to boiler
Steam heating time:	From coffee temperature to 127°C - Approx. 50 sec.
Coffee dispensing temperature:	Approx. 86° C
Grinding time:	Initial grinding with completely empty machine: Approx. 15 sec. / subsequent grinding: approx. 5.5 sec.
Time to make espresso:	Approx. 28 sec. for 50 ml
Time to make cup of coffee:	Approx. 40 sec. for 100 ml

2. Technical data (Royal Digital / Exclusive/ Digital Redesign)

Royal Digital / Exclusive / Digital Redesign	
Technical data	
Power supply/output:	230V 50Hz 1250W
Safety system:	170°C Safety thermostat for instantaneous water heater
Temperature monitoring:	KTY Temperature sensors transmit respective temperatures to electronic system
Continuous flow thermoblock:	Instantaneous water heater (1090 W) for coffee and hot water dispensing
Pump:	Ulka reciprocating piston pump with angle connector and thermostat - 48 W, 230V, 50 Hz. Type EX5, 20 l/h
Safety valve:	Conventional safety valve connected to pump
Water filter:	Installed in machine in front of the turbine and pump.
Gearmotor:	Direct current, 30 - 35 V
Cup warmer/gear resistor:	Approx. 437W / 130Ω
Grinder (conical grinder):	Plastic grinding screw, galvanised steel grinding cone and grinding disc Direct current, 260 V
Motor:	
Second doser:	Coffee dose adjustable by means of lever (6 - 9g) outside housing 230 V - Magnet coil
Second doser:	Doser for powder coffee, by means of measuring spoon
Power consumption:	During heating - approx. 4.5 A Standby - Approx. 0.04 A
Pump pressure:	Max. 15 bar
Dimensions W x D x H in mm:	330/385/395 (Digital) 385/450/395(Exclusive)
Weight:	Approx. 15 kg
Capacity of coffee bean container:	Approx. 300g
Capacity of water tank:	Approx. 2.4 l max.
Boiler - Capacity:	Approx. 1.0 ccm, 10 ml volume
De-aeration time:	Approx. 1 - 2 sec. for initial start-up
Heating time:	Approx. 80 sec. with water at 10°C
Re-heating time:	None due to boiler
Steam heating time:	From coffee temperature to 127°C - Approx. 50 sec.
Coffee dispensing temperature:	Approx. 86° C
Grinding time:	Initial grinding with completely empty machine: Approx. 15 sec. / subsequent grinding: approx. 5.5 sec.
Time to make espresso:	Approx. 28 sec. for 50 ml
Time to make cup of coffee:	Approx. 40 sec. for 100 ml

3. Technical data (Royal Professional Instant Steam / Cappuccino / Cappuccino Redesign)

Royal Professional Instant Steam / Cappuccino / Cappuccino Redesign	
Technical data	
Power supply/output:	230V 50Hz 2300W
Safety system:	170°C Safety thermostat for instantaneous water heater
Temperature monitoring:	KTY Temperature sensors transmit respective temperatures to electronic system
Continuous flow thermoblock:	Instantaneous water heater - 1090 W, supplementary heating 437 W for coffee and hot water dispensing
Second thermoblock:	Instantaneous water heater for steam dispensing (instant steam) - 1090 W In Redesign this feature takes the form of pipe heating.
Pump:	Ulka reciprocating piston pump with angle connector and thermostat - 48 W, 230V, 50 Hz. Type EX5, 20 l/h
Second pump:	Technical data as above (for instant steam function)
Safety valve:	Conventional safety valve connected to pump
Water filter:	Installed in machine in front of the turbine and pump.
Gearmotor:	Direct current, 30 - 35 V
Cup heater/Gear resistor:	Approx. 437W / 130Ω
Grinder (conical grinder):	Plastic grinding screw, galvanised steel grinding cone and grinding disc
Motor:	260 V Direct current
Second doser:	Coffee dose adjustable by means of lever (6 - 9g) outside housing 230 V - Magnet coil
Second doser:	Doser for powder coffee, by means of measuring spoon
Power consumption:	During heating - approx. 9 A Standby - Approx. 0.04 A
Pump pressure:	Max. 15 bar
Dimensions W x D x H in mm:	385/450/395
Weight:	Approx. 16 kg
Capacity of coffee bean container:	Approx. 300g
Capacity of water tank:	Approx. 2.4 l max.
Instantaneous water heater capacity:	Approx. 1.0 ccm, 10 ml volume
De-aeration time:	Approx. 1 - 2 sec. for initial star-up
Heating time:	Approx. 80 sec. with water at 10°C
Re-heating time:	None due to boiler
Steam heating time:	None due to second instantaneous water heater (steam dispensing possible even during coffee dispensing / second pump)
Coffee dispensing temperature:	Approx. 86° C
Grinding time:	Initial grinding with completely empty machine: Approx. 15 sec. / subsequent grinding: approx. 5.5 sec.
Time to make espresso:	Approx. 28 sec. for 50 ml
Time to make cup of coffee:	Approx. 40 sec. for 100 ml

4. Technical data (Royal Digital Plus / Professional Rapid Steam / Prof. Redesign / Coffeebar)

Royal Digital Plus / Professional Rapid Steam / Prof. Redesign / Coffeebar	
Technical data	
Power supply/output:	230V 50Hz 1600W
Safety system:	170°C Safety thermostat for instantaneous water heater
Temperature monitoring:	KTY Temperature sensors transmit respective temperatures to electronic system
Continuous flow thermoblock:	Instantaneous water heater - 1090 W - supplementary heating 437 W for coffee and hot water dispensing
Pipe heating:	1000W – Steam dispensing (rapid steam)
Pump:	Ulka reciprocating piston pump with angle connector and thermostat - 48 W, 230V, 50 Hz. Type EX5, 20 l/h
Safety valve:	Conventional safety valve connected to pump
Water filter:	Installed in machine in front of the turbine and pump.
Gearmotor:	Direct current, 30 - 35 V
Cup heater/Gear resistor:	Approx. 437W / 130Ω
Grinder (conical grinder):	Plastic grinding screw, galvanised steel grinding cone and grinding disc
Motor:	260 V Direct current
Second doser:	Coffee dose adjustable by means of lever (6 - 9g) outside housing 230 V - Magnet coil
Second doser:	Doser for powder coffee, by means of measuring spoon
Power consumption:	During heating - approx. 5.7 A Standby - Approx. 0.04 A
Pump pressure:	Max. 15 bar
Dimensions W x D x H in mm:	385/450/395 (Royal Profi new) 385/480/395 (Royal Coffeebar)
Weight:	Approx. 16 kg
Capacity of coffee bean container:	Approx. 300g
Capacity of water tank:	Approx. 2.4 l max.
Fixed water connection: (only for Royal Coffeebar)	Inlet valve / non-return valve Pressure control - 0.8 bar
Instantaneous water heater capacity:	Approx. 1.0 ccm, 10 ml volume
De-aeration time:	Approx. 1 - 2 sec. for initial star-up
Heating time:	Approx. 90 sec. with water at 10°C
Re-heating time:	None due to boiler
Steam heating time:	None, due to pipe heating
Coffee dispensing temperature:	Approx. 86° C
Grinding time:	Initial grinding with completely empty machine: Approx. 15 sec. / subsequent grinding: approx. 5.5 sec.
Time to make espresso:	Approx. 28 sec. for 50 ml
Time to make cup of coffee:	Approx. 40 sec. for 100 ml

5. Technical data (Royal Office)

Royal Office	
Technical data	
Power supply/output:	230V 50Hz 1500W
Safety system:	170°C Safety thermostat for instantaneous water heater
Temperature monitoring:	KTY Temperature sensors transmit respective temperatures to electronic system
Continuous flow thermoblock:	Instantaneous water heater (1090 W) for coffee and hot water dispensing
Pump:	Ulka reciprocating piston pump with angle connector and thermostat - 48 W, 230V, 50 Hz., Type EX5 20 l/h
Safety valve:	Conventional safety valve connected to pump
Water filter:	Installed in machine in front of the turbine and pump.
Gearmotor:	Direct current, 30 - 35 V
Gear resistor:	Approx. 437W / 130Ω
Grinder (conical grinder):	Plastic grinding screw, galvanised steel grinding cone and grinding disc
Motor:	260 V Direct current
Second doser:	Coffee dose adjustable by means of lever (6 - 9g) outside housing 230 V - Magnet coil
Second doser:	No
Power consumption:	During heating - approx. 5.7 A Standby - Approx. 0.04 A
Pump pressure:	Max. 15 bar
Dimensions W x D x H in mm:	385/450/460
Weight:	Approx. 14 kg
Capacity of coffee bean container:	Approx. 1,000g
Capacity of water tank:	Approx. 6 l max.
Instantaneous water heater capacity:	Approx. 1.0 ccm, 10 ml volume
De-aeration time:	Approx. 1 - 2 sec. for initial star-up
Heating time:	Approx. 90 sec. with water at 10°C
Re-heating time:	None due to boiler
Steam heating time:	From coffee temperature to 127°C - Approx. 50 sec.
Coffee dispensing temperature:	Approx. 86° C
Grinding time:	Initial grinding with completely empty machine: Approx. 15 sec. / subsequent grinding: approx. 5.5 sec.
Time to make espresso:	Approx. 28 sec. for 50 ml
Time to make cup of coffee:	Approx. 40 sec. for 100 ml

CHAPTER 3

OPERATION

	Page
1. Operation (Royal Classic)	1
1.1. Operating instructions	1
2. Operation (Royal Exclusive/Digital/Digital Redes.)	3
2.1. Operating instructions	3
2.2. User programme	5
3. Operation (Profess. Instant Steam Cappuccino/ Cappuccino Redesign / Profess. Redesign)	7
3.1. Operating instructions	7
3.2. User programme	10
4. Operation (Professional-Rapid Steam/Coffeebar/ Digital Plus)	12
4.1. Operating instructions	12
4.2. User programme	15
4.3. Vending menu	17
5. Operation (Royal Office)	19
5.1. Operating instructions	19
5.2. User programme	21
5.3. Vending menu	24

1. Operation (Royal Classic)

1.1. Operating instructions (quick reference)

	Action	Comments	HS LED	Temp. LED	Steam LED
Getting started					
1	Unpack machine.	Check for damage.			
2	Fill water tank				
3	Fill coffee beans container.				
4	Connect mains plug.				
5	Turn on main switch.		Light on		
6	De-aerate water circuit.	Open hot water pressure valve until water flows.	Light on		
		Heating stage (approx. 1.5 min).	Light on	Light flashes	
		Ready	Light on	Light on	
Making coffee					
7	Select coffee quantity using the control dial.	Depending on cup size.	Light on	Light on	
8	Place cup under dispenser.		Light on	Light on	
9	Press start button (coffee button).	Press once = 1 cup of coffee. Press twice = 2 cups of coffee.	Light on	Flashes once	
				Flashes twice	
10	To interrupt coffee making.	Press start button again.			
Dispensing steam					
11	Press steam button.	Heating stage.	Light on		Light flashes
12		Ready	Light on		Light on
13	Steam dispensing. Open tap valve.	To warm coffee. To froth milk.	Light on		Light on
14	Press steam button / deactivate steam function.	Cooling stage (can be accelerated by de-aerating)	Light on	Light flashes	Light flashes
		Ready (to make coffee)	Light on	Light on	
Cleaning					
Empty dregs drawer	Storage capacity of 30 tablespoons (dreg counter reset only if warning to empty grounds container is triggered and machine is turned on)				
Empty drip tray	After 30 servings				
Clean water tank	As required				
Clean coffee bean container.	As required				
Clean the housing	As required				
Rinse brewing unit	1 x per week				
Clean brewing unit and oil filter	1 x per month				
Descale	Depending on water hardness				

Descal	
Water hardness	Descaling frequency
Very hard water (over 21°dH)	About every 4 weeks
Hard water (15°-21°dH)	About every 6 weeks
Medium water (15°-21°dH)	About every 2 months
Soft water (up to 7°dH)	About every 3 months
Do not use vinegar! (damages the pump)	

Descaling procedure:

1. Place Saeco descaler into fresh water tank.
2. Fill with about one litre of hot water.
3. Make 2-3 coffees to descale coffee circuit.
4. Remove the remaining descaler mixture in cupfuls via the HWS valve in intervals of about 5 – 10 min.
6. Rinse the machine with about 2 litres of fresh water. Make 2-3 coffees to rinse coffee circuit (brewing unit filter(s) must be cleaned before descaling).

Troubleshooting		
Fault	Possible cause	Remedy
Does not function	No power	Check mains plug / mains circuit breaker / and ensure machine door is closed.
Brewing unit does not turn on (alarm LED flashes)	Brewing unit not properly installed or not closed.	Install brewing unit correctly.
	Coffee grinds container not properly installed.	Install brewing unit correctly.
Brewing unit does not turn on (alarm LED on)	Coffee bean container is empty.	Fill coffee beans container.
	Water tank is empty.	Fill water tank.
Brewing unit does not turn on (steam LED flashes)	After steam dispensing the system is not or is insufficiently de-aerated.	De-aerate machine.
No water / steam	Air in the circuit.	De-aerate.
	Steam nozzle blocked.	Free opening using a thin needle.
The coffee flows too quickly	Beans ground too coarsely.	Select lower grind level; e.g. change from 5 to 3.
The coffee flows too slowly	Beans ground too finely.	Select higher grind level; e.g. change from 5 to 7.
Coffee has no froth.	Unsuitable coffee blend.	Change brand of coffee.
	Coffee is no longer freshly roasted.	Use fresh coffee.
	Beans ground too coarsely or finely.	Change grind level.
Longer heating time or less hot water.	The machine is calcified.	Decalcify machine.
The brewing unit cannot be removed.	The brewing unit is not in home position.	Turn machine on, close service door and check dregs drawer (the brewing unit goes automatically to home position).

2. Operation (Royal Digital / Exclusive / Digital Redesign)

2.1. Operating instructions (quick reference)

	Action	Comments	Display
Getting started			
1	Unpack machine.	Check for damage.	
2	Fill water tank		
3	Fill coffee beans container.		
4	Connect mains plug.		
5	Turn on main switch.		Self test/ Heating
6	De-aerate water circuit.	Open hot water pressure valve until water flows.	Heating
		Heating stage (approx. 80 sec.)	Heating
		Ready	Select product Ready for operation
Making coffee			
7	Programme coffee quantity for each selection button. <ul style="list-style-type: none"> • Espresso lungo • Coffee • Espresso 	Depending on cup size. Programme by keeping the coffee selection button pressed until the desired quantity is reached.	Quantity programme
8	Place cup under dispenser.		Select product Ready for operation
9	Select programme and press appropriate button.	Press once = 1 cup of coffee Press twice = 2 cups of coffee.	1 Coffee 2 Coffees
Coffee dispensing / Powder coffee			
10	Place cup under dispenser.	Place powder coffee in powder container (1 measuring spoonful)	
11	Select powder button and relevant coffee button (long coffee / coffee / espresso)	Only one coffee can be dispensed at a time.	Select product Powder coffee
Dispensing steam			
12	Press steam button.	Heating stage.	Steam Heating
		Ready	Steam Ready for operation
14	Steam dispensing. Open HWS valve	To warm coffee. To froth milk.	Steam
15	Press steam button / deactivate steam function.	Cooling stage (can be accelerated by de-aerating)	Overheating
16	De-aerate		Hot water Overheating
		Ready (to make coffee)	Ready for operation

Descale: See Royal Cappuccino

Cleaning	
Empty dregs drawer	Storage capacity of 30 tablespoons (dreg counter reset only if warning to empty grounds container is triggered and machine is turned on).
Empty drip tray	After 30 servings
Clean water tank.	As required.
Clean coffee bean container.	As required.
Clean the housing.	As required.
Rinse brewing unit	1 x per week
Clean brewing unit and oil filter	1 x per month
Descale	Depending on water hardness.

Troubleshooting		
Fault/Indicator	Possible cause	Remedy
Does not function	No power	Check mains plug / mains circuit breaker / Ensure machine door is closed.
BREWING UNIT NOT DETECTED	Brewing unit not properly installed or not closed.	Install brewing unit correctly.
GRINDS CONTAINER NOT DETECTED	Coffee grinds container not properly installed.	Brewing unit correctly installed.
COFFEE BEAN CONTAINER EMPTY	Coffee bean container is empty.	Fill coffee container.
FILL WATER DE-AERATE	Water tank is empty.	Water tank
OVERHEATING	After steam dispensing the system is not or is insufficiently de-aerated.	De-aerate machine.
GRINDER OBSTRUCTED		Clean grinder.
DE-AERATE	Air in water system.	Open water nozzle.
Instead of coffee, only water is dispensed.	Coffee powder selection button is pressed, but no coffee is dispensed.	Add one level measure of coffee powder.
No water / steam	Steam nozzle blocked.	Free opening using a thin needle.
The coffee flows too quickly	Beans ground too coarsely.	Select lower grind level; e.g. change from 5 to 3.
The coffee flows too slowly	Beans ground too finely.	Select higher grind level; e.g. change from 5 to 7.
Coffee is not hot enough	The cups are cold.	Pre-heat cups.
	Boiler temperature too low.	Increase temperature in user programme.
Coffee has no froth.	Unsuitable coffee blend.	Change brand of coffee.
	Coffee is no longer freshly roasted.	Use fresh coffee.
	Beans ground too coarsely or finely.	Change grind level.
Longer heating time or less hot water.	The machine is calcified.	Decalcify machine.
The brewing unit cannot be removed.	The brewing unit is not in home position.	Turn machine on, close service door and check dregs drawer.(the brewing unit goes automat. to home position)

2.2. User programme (Royal Digital / Exclusive / Digital Redesign)

The table below indicates the various values, settings and programmes which can be read and selected through the user programme options. Various cleaning programmes can also be activated.

Access (Royal Digital / Exclusive): Access via the ENTER button.

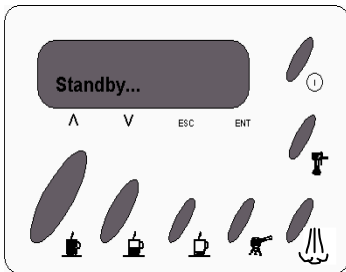

Access (Royal Digital Redesign): Selection entry via menu button.

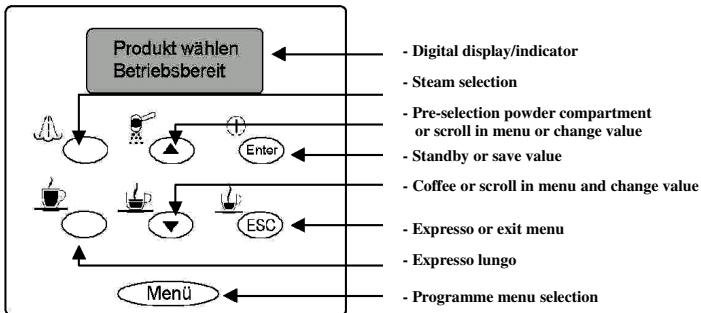

Menu procedure:

1. Select desired programme using the cursor buttons (arrow buttons).
2. Access appropriate item using the ENTER button.
3. Use the arrow buttons to handle each item.
4. Confirm with the ENTER button.

Item	Setting/Indicator	Standard	Function
Language	Country	German	Display language
Rinse	ON/OFF	OFF	Rinses residual water from circuit every time the machine is turned on (temp. of instantaneous water heater < 50°C) (not in Royal Exclusive) .
Water hardness	1 – 500 l	3	Change in coffee quantity until descaling required (1-4).
	2 – 300 l		
	3 – 150 l		
	4 – 80 l		

Item	Setting/Indicator	Standard	Function
Heating plate	ON/OFF		Activate / deactivate heating plate.
Temperature	Maximum	Medium	Adjustment of coffee temperature.
	High		
	Medium		
	Low		
Pre-brewing	ON	ON	Coffee is moistened before actual brewing (better aroma)
	LONG		
	AUS		
Pre-grinding	ON/OFF	OFF	Pre-grinds the next coffee dose.
Total coffee	Number		Coffee quantity indicator
Descale			Activate descaling programme (when descaling required)
Scale indicator reset	YES/NO		Counter reset (only if descaling indicator is activated). With the exception of Royal Exclusive: Reset via steam button.
Timer	0-12.45 hours	0	Machine switches to standby mode if not used within the programmed time. (Standby mode can also be activated at any time via the menu buttons.)
Cleaning cycle			Cleaning programme for brewing unit
Factory settings			Initialise standard settings (only for Royal Dig. Redesign)

Exit: ESC button / Menu item - EXIT and ENTER (depending on programme).

3. Operation (Royal Professional Instant Steam / Prof. Redesign / Cappuccino / Capp. Redesign)

3.1. Operating instructions (quick reference)

	Action	Comments	Display
Getting started			
1	Unpack machine.	Check for damage.	
2	Fill water tank		
3	Fill coffee beans container.		
4	Connect mains plug.		
5	Turn on main switch.		Self test/ Heating
6	De-aerate water circuit.	Activate the hot water button until water flows continuously	Heating
		Heating stage (approx. 80 sec.)	Heating
		Ready	Select product Ready for operation
Making coffee			
7	Programme coffee quantity for each selection button. <ul style="list-style-type: none"> • Espresso lungo • Coffee • Espresso 	Depending on cup size. Programme by keeping the programme selection button pressed until the desired quantity is reached.	Quantity programme
8	Place cup under dispenser.		Select product Ready for operation
9	Select programme and press appropriate button.	Press once = 1 cup of coffee. Press twice = 2 cups of coffee.	1 Coffee 2 Coffees
Coffee dispensing / Powder coffee			
10	Place cup under dispenser.	Place powder coffee in powder container (1 measuring spoonful)	
11	Select powder button and relevant coffee button (long coffee / coffee / espresso)	Only one coffee can be dispensed at a time.	Select product Powder coffee
Dispensing steam			
14	Steam dispensing. Open steam valve	To warm coffee. To froth milk.	Steam
Hot water			
15	Hot water (only when hot water programme is deactivated in the user menu).	Press the hot water button briefly to start hot water dispensing; press again to stop.	Hot water
16	Hot water quantity programming (only when hot water programme is activated in the user menu).	Keep the hot water button pressed for the desired time. The last programme entered is saved	Hot water Quantity programme

	Action	Comments	Display
17	Hot water Quantity programme	The last programme saved is activated by pressing the hot water button briefly.	Hot water
Cappuccino maker			
18	Cappuccino (only when cappuccino maker programme is deactivated in the user menu)	Press the cappuccino button briefly to start cappuccino dispensing; press again to stop.	Cappuccino
19	Cappuccino Quantity programme (only when cappuccino maker programme is activated in the user menu)	Keep the cappuccino button pressed for the desired time. The last programme entered is saved	Cappuccino Quantity programme
20	Cappuccino Quantity programme	The last programme saved is activated by pressing the Cappuccino button briefly.	Cappuccino

Note: The Steam and Cappuccino functions can be used parallel to the coffee programme in the Royal Professional Instant Steam, Royal Cappuccino and Royal Cappuccino Redesign systems.

Cleaning	
Empty dregs drawer	Storage capacity of 30 tablespoons (dreg counter reset only if warning to empty grounds container is triggered and machine is turned on)
Empty drip tray	After 30 servings
Clean water tank.	As required
Clean coffee bean container.	As required
Clean the housing.	As required
Rinse brewing unit	1 x per week
Clean brewing unit and lubricate Clean filter	1 x per month
Descale	Depending on water hardness.

- Descale:**
1. Place Saeco descaler into fresh water tank.
 2. Fill with about one litre of hot water.
 3. Remove about two to three cups via the brewing unit (cannot be poured).
 4. Activate the Descale item in the user menu by selecting OK and open the HWS valve (place a sufficiently large container under the steam pipe). The descaler mixture is pumped at intervals through the circuit.
 5. Rinse: Fill the water tank once again and open the steam valve (about 2-3 cups via brewing unit).

Reset: Under the descale indicator item (Enter - YES - Enter).

Troubleshooting		
Fault/Indicator	Possible cause	Remedy
Does not function	No power	Check mains plug / mains circuit breaker / Ensure machine door is closed.
BREWING UNIT NOT DETECTED	Brewing unit not properly installed or not closed.	Install brewing unit correctly.
GRINDS CONTAINER NOT DETECTED	Coffee grinds container not properly installed.	Brewing unit correctly installed.
COFFEE BEAN CONTAINER EMPTY	Coffee bean container is empty.	Fill coffee container.
FILL WATER DE-AERATE	Water tank is empty.	Water tank
OVERHEATING	After steam dispensing the system is not or is insufficiently de-aerated.	De-aerate machine.
GRINDER OBSTRUCTED		Clean grinder.
DE-AERATE	Air in water system.	Press hot water button.
Instead of coffee, only water is dispensed.	Coffee powder selection button is pressed, but no coffee powder is dispensed.	Add one level measure of coffee powder.
No water / steam	Steam nozzle blocked.	Free opening using a thin needle.
The coffee flows too quickly	Beans ground too coarsely.	Select lower grind level; e.g. change from 5 to 3.
The coffee flows too slowly	Beans ground too finely.	Select higher grind level; e.g. change from 5 to 7.
Coffee is not hot enough	The cups are cold.	Pre-heat cups.
	Instantaneous water heater temperature too low.	Increase temperature in user programme.
Coffee has no froth.	Unsuitable coffee blend.	Change brand of coffee.
	Coffee is no longer freshly roasted.	Use fresh coffee.
	Beans ground too coarsely or finely.	Change grind level.
Longer heating time or less hot water.	The machine is calcified.	Decalcify machine.
The brewing unit cannot be removed.	The brewing unit is not in home position.	Turn machine on, close service door and check dregs drawer. (the brewing unit goes automatically to home position)

3.2. User programme (Royal Professional Instant Steam / Royal Cappuccino)

The table below indicates the various values, settings and programmes which can be read and selected through the user programme options.

Various cleaning programmes can also be activated.

Access: Access is via the ENTER button (keep pressed for a few seconds).

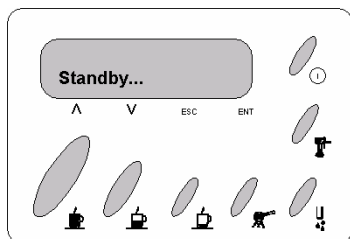

Access (Royal Prof. Redesign / Capp Redesign): Selection entry via menu button.

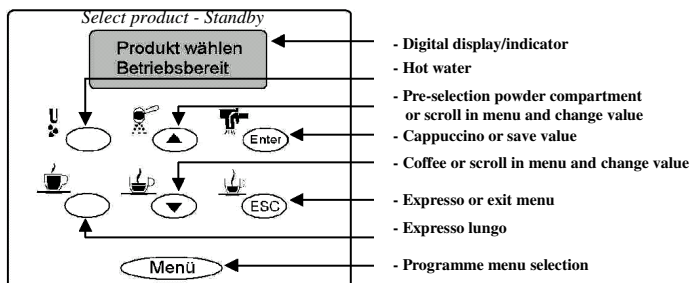

Menu procedure:

1. Select desired programme using the cursor buttons (arrow buttons).
2. Access appropriate item using the ENTER button.
3. Use the arrow buttons to handle each item.
4. Confirm with the ENTER button.

Item	Setting/Indicator	Standard	Function
Standby	Standby		
			Only for Redesign Series
Language	Country	German	Display language
Rinse	ON/OFF	OFF	Rinses every time the machine is turned on (temp. of instantaneous water heater < 50°C) Not Roy. Cappuccino

Item	Setting/Indicator	Standard	Function
System 2	ON/OFF		Steam function deactivation Not for Roy. Prof. Redes.
Water hardness	1 – 500 l	3	Change in coffee quantity until descaling required (1-4).
	2 – 300 l		
	3 – 150 l		
	4 – 80 l		
Heating plate	ON/OFF	OFF	Activate / deactivate heating plate.
Temperature (Espresso lungo)	Maximum	Medium	Adjustment of coffee temperature.
	High		
	Medium		
	Low		
Temperature (Coffee)	Maximum	Medium	Adjustment of coffee temperature.
	High		
	Medium		
	Low		
Temperature (Espresso)	Maximum	Medium	Adjustment of espresso temperature.
	High		
	Medium		
	Low		
Pre-brewing	ON	ON	Coffee is moistened before actual brewing (better aroma)
	LONG		
	OFF		
Pre-grinding	ON/OFF	OFF	Pre-grinds the next coffee dose.
Hot water programme	ON/OFF		Activates or deactivates the hot water quantity programme (see Operation)
Cappuccino programme	ON/OFF		Activates or deactivates the cappuccino quantity programme (see Operation)
Total coffee	Number		Indicates the number of coffees dispensed
Descal			Activate descaling programme
Scale indicator	YES/NO		Counter reset (only if descaling indicator is activated).
Timer	0-12.45 hours	0	Machine switches to standby mode if not used within the programmed time. (Standby mode can also be activated at any time via the menu buttons.)
Vending			Programming for the purposes of vending
Cleaning cycle			Not relevant in Austria Not Roy. Cappuccino
Factory settings			Reset standard values Not Roy. Cappuccino
Exit			Exit Not Roy. Redesign

Exit: Exit – Enter / ESC depending on type

4. Operation (Professional Rapid Steam / Coffeebar / Digital Plus)

4.1. Operating instructions (quick reference)

	Action	Comments	Display
Getting started			
1	Unpack machine.	Check for damage.	
2	Fill water tank		
3	Fill coffee beans container.		
4	Connect mains plug.		
5	Turn on main switch.		Self test/ Heating
6	De-aerate water circuit.	Activate the hot water button until water flows continuously	Heating
		Heating stage (approx. 80 sec.)	Heating
		Ready	Select product Ready for operation
Making coffee			
7	Programme coffee quantity for each selection button. <ul style="list-style-type: none"> • Espresso lungo • Coffee • Espresso 	Depending on cup size. Programme by keeping the programme selection button pressed until the desired quantity is reached.	Quantity programme
8	Place cup under dispenser.		Select product Ready for operation
9	Select programme and press appropriate button.	Press once = 1 cup of coffee. Press twice = 2 cups of coffee.	1 Coffee 2 Coffees
Coffee dispensing / Powder coffee			
10	Place cup under dispenser.	Place powder coffee in powder container (1 measuring spoonful)	
11	Select powder button and relevant coffee button (long coffee / coffee / espresso)	Only one coffee can be dispensed at a time.	Select product Powder coffee
Dispensing steam			
14	Steam dispensing. Open steam valve	To warm coffee. To froth milk.	Steam
Hot water			
15	Hot water (only when hot water programme is deactivated in the user menu).	Press the hot water button briefly to start hot water dispensing; press again to stop.	Hot water
16	Hot water quantity programming (only when hot water programme is activated in the user programme).	Keep the hot water button pressed for the desired time. The last programme entered is saved .	Hot water Quantity programme

	Action	Comments	Display
17	Hot water Quantity programme	The last programme saved is activated by pressing the hot water button briefly.	Hot water
Cappuccino Maker (not in Royal Digital+)			
18	Cappuccino (only when cappuccino maker programme is deactivated in the user menu)	Press the cappuccino button briefly to start cappuccino dispensing; press again to stop.	Cappuccino
19	Cappuccino Quantity programme (only when cappuccino maker programme is activated in the user menu)	Keep the cappuccino button pressed for the desired time. The last programme entered is saved	Cappuccino Quantity programme
20	Cappuccino Quantity programme	The last programme saved is activated by pressing the Cappuccino button briefly.	Cappuccino

Note: The Steam and Cappuccino functions cannot be used parallel to the coffee programme in the Royal Professional Rapid Steam, Royal Coffeebar and Royal Digital + systems.

Cleaning	
Empty dregs drawer	Storage capacity of 30 tablespoons (dreg counter reset only if warning to empty grounds container is triggered and machine is turned on).
Empty drip tray	As required
Clean water tank.	As required
Clean coffee bean container.	As required
Clean the housing.	As required
Clean brewing unit and grease filter.	1 x per month
Descale	According to indicator

- Descale:**
1. Place Saeco descaler into fresh water tank.
 2. Fill with about one litre of hot water.
 3. Remove about two to three cups via the brewing unit.
 4. Activate the Descale item in the user menu by selecting OK and open the HWS valve (place a sufficiently large container under the steam pipe). The descaler mixture is pumped at intervals through the circuit.
 5. Rinse: Fill the water tank once again and open the steam valve (about 2 cups via brewing unit).

Reset: Under the descale indicator item Enter - YES - Enter.

Troubleshooting		
Fault/Indicator	Possible cause	Remedy
Does not function	No power	Check mains plug / mains circuit breaker / Ensure machine door is closed.
BREWING UNIT NOT DETECTED	Brewing unit not properly installed or not closed.	Install brewing unit correctly.
GRINDS CONTAINER NOT DETECTED	Coffee grinds container not properly installed.	Brewing unit correctly installed.
COFFEE BEAN CONTAINER EMPTY	Coffee bean container is empty.	Fill coffee container.
FILL WATER DE-AERATE	Water tank is empty.	Water tank
OVERHEATING	After steam dispensing the system is not or is insufficiently de-aerated.	De-aerate machine.
GRINDER OBSTRUCTED		Clean grinder.
DE-AERATE	Air in water system.	Press hot water button.
Instead of coffee, only water is dispensed.	Coffee powder selection button is pressed, but no coffee powder is dispensed.	Add one level measure of coffee powder.
No water / steam	Steam nozzle blocked.	Free opening using a thin needle.
The coffee flows too quickly	Beans ground too coarsely.	Select lower grind level; e.g. change from 5 to 3.
The coffee flows too slowly	Beans ground too finely.	Select higher grind level; e.g. change from 5 to 7.
Coffee is not hot enough	The cups are cold.	Pre-heat cups.
	Boiler temperature too low.	Increase temperature in user programme.
Coffee has no froth.	Unsuitable coffee blend.	Change brand of coffee.
	Coffee is no longer freshly roasted.	Use fresh coffee.
	Beans ground too coarsely or finely.	Change grind level.
Longer heating time or less hot water.	The machine is calcified.	Decalcify machine.
The brewing unit cannot be removed.	The brewing unit is not in home position.	Turn machine on, close service door and check dregs drawer. (the brewing unit goes automatically to home position)

4.2. User programme (Royal Professional Rapid Steam / Coffeebar / Digital Plus)

The table below indicates the various values, settings and programmes which can be read and selected through the user programme options. Various cleaning programmes can also be activated.

Access: Access is via the ENTER button.

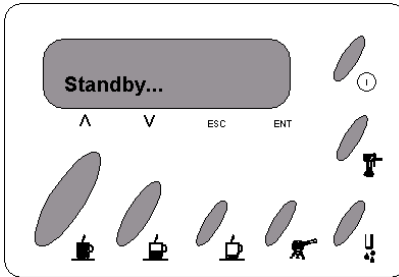

Access (Digital+): Selection entry via menu button.

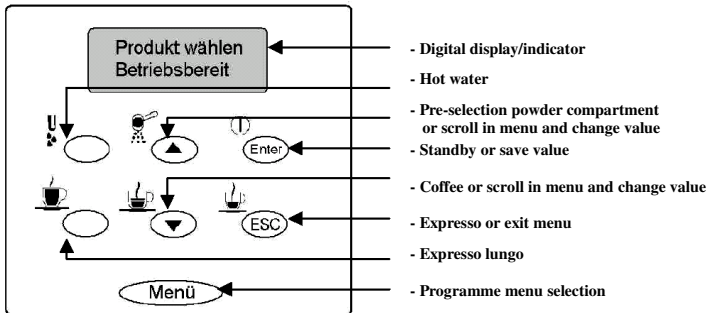

Menu procedure:

1. Select desired programme using the cursor buttons (arrow buttons).
2. Access appropriate item using the ENTER button.
3. Use the arrow buttons to handle each item.
4. Confirm with the ENTER button.

Item	Setting/Indicator	Standard	Function
Language		German	Select display language.
Rinse	ON/OFF	OFF	Rinses residual water through pipes each time machine turned on (only when machine is cold).
Water hardness	1 – 500 l	3	Change in coffee quantity until descaling required (1-4).
	2 – 300 l		
	3 – 150 l		
	4 – 80 l		

Item	Setting/Indicator	Standard	Function
Heating plate	ON/OFF		Activate / deactivate heating plate. Heating plate
Temperature (Espresso lungo)	Maximum	Medium	Adjustment of coffee temperature.
	High		
	Medium		
	Low		
Temperature (Coffee)	Maximum	Medium	Adjustment of coffee temperature.
	High		
	Medium		
	Low		
Temperature (Espresso)	Maximum	Medium	Adjustment of espresso temperature.
	High		
	Medium		
	Low		
Pre-brewing	ON	ON	Coffee is moistened before actual brewing (better aroma)
	LONG		
	OFF		
Pre-grinding	ON/OFF	OFF	Pre-grinds the next coffee dose.
Hot water programme	ON/OFF		Activates or deactivates the hot water quantity programme (see Operation)
Cappuccino programme	ON/OFF		Activates or deactivates the cappuccino quantity programme (see Operation) (not for Digital+)
Total coffee	Number		Coffee quantity indicator
Descale			Activate descaling programme (when descaling required)
Scale indicator	YES/NO		Counter reset (only if descaling indicator is activated).
Timer	0-12.45 hours	0	Machine switches to standby mode if not used within the programmed time. (Standby mode can also be activated at any time via the standby button.)
Vending			Programming for the purposes of vending (not for Digital+)
Cleaning cycle	YES/NO		Activates the cleaning programme for the brewing unit.
Factory settings	YES/NO		Activates fixed water connection. (only Roy. Digital+)
Fixed water	YES/NO		Activates fixed water connection. (only Roy. Coffeebar/ Professional)

Exit: ESC button

4.3. Vending menu:

	Action	Procedure	Display
Enter code			
	Access	Confirm vending in user menu via ENTER.	Code ****
	Call up code entry	Press ENTER	Change code / New code? 0***
	Code entry	Enter required number combination by using the arrow and enter buttons	New code = number Save No
	Confirm code	Use arrow button to select Yes	New code = number Save Yes
	Confirm code	Press ENTER	Code ****
		Use arrow button to access menu items.	
Change code			
	Access	Confirm vending in user menu via ENTER.	Code ****
	Call up code entry	Press ENTER	Change code / Old code? 0***
	Code entry	Enter number combination by using the arrow and enter buttons	New code? 0***
	Code entry	Enter required number combination by using the arrow and enter buttons	New code = number Save No
	Confirm code	Use arrow button to select Yes	New code = number Save Yes
	Confirm code	Press ENTER	Code ****
		Use arrow button to access menu items.	
Vending menu			
	Item	Indication	Comments
	1 espresso lungo Total Number	Number of espresso lungo dispensed since last reset	Reset: Espresso lungo + ESC
	1 coffees Total Number	Number of coffees dispensed since last reset	Reset: Espresso lungo + ESC
	1 espresso Total Number	Number of espresso dispensed since last reset	Reset: Espresso lungo + ESC
	Hot water Total Number	Number of hot water portions dispensed since last reset	Reset: Espresso lungo + ESC
	Counter Lock: Number	Number of coffees dispensed	Reset: Espresso lungo + ESC Change value: Arrow button Espresso lungo + arrow button
	Counter Cycles Number	Number of coffees dispensed since last reset	Reset: Espresso lungo + ESC Change value: Arrow button Espresso lungo + arrow button

Note:

- The vending menu can also be used unsecured (no code entry / skip code entry via arrow button).
- Cancelling code: Enter with new code 0000.
- If the programmed code is only used to read the counter reading, the code entry can also be skipped. However, if an attempt is made to change the counter reading, the code request appears.

Attention: If you forget the code, a new code must be requested from Saeco Austria!

5. Operation (Royal Office)

5.1. Operating instructions (quick reference)

	Action	Comments	Display
Getting started			
1	Unpack machine.	Check for damage.	
2	Fill water tank		
3	Fill coffee beans container.		
4	Connect mains plug.		
5	Turn on main switch.		Self test/ Heating
6	De-aerate water circuit.	Activate the hot water button until water flows continuously	Heating
		Heating stage (approx. 80 sec.)	Heating
		Ready	Select product Ready for operation
Making coffee			
7	Programme coffee quantity for each selection button. <ul style="list-style-type: none"> • Coffee • Espresso 	Depending on cup size. Programme by keeping the programme selection button pressed until the desired quantity is reached. Programming is only possible when quantity programme in the user menu is ON.	Quantity programme
8	Place cup under dispenser.		Select product Ready for operation
9	Select programme and press appropriate button.	Press once = 1 cup of coffee. Press twice = 2 cups of coffee.	1 Coffee 2 Coffees
Hot water			
15	Hot water	Press the hot water button briefly to start hot water dispensing; press again to stop.	Hot water

Counter reading indicator:

Indication	Command	Comments
Total coffee	C	Indicates the espressos and coffees dispensed Not resettable
1 coffee Total Number	C + Espresso	Indicates the espressos dispensed Resettable (in vending menu)
2 coffees Total Number	C + Coffee	Indicates the coffees dispensed Resettable (in vending menu)
Total Number	C + Espr. + Coffee	Indicates the espressos and coffees dispensed Resettable (in vending menu)
Hot water Total Number	C + Hot water	Indicates the hot water dispensed Resettable (in vending menu)

Cleaning	
Empty dregs drawer	Storage capacity of 30 tablespoons (dreg counter reset only if warning to empty grounds container is triggered and machine is turned on).
Empty drip tray	With dregs drawer
Clean water tank.	As required
Clean coffee bean container.	As required
Clean the housing.	As required
Rinse brewing unit	1 x per week
Clean brewing unit and lubricate	1 x per month
Clean filter	
Descale	According to indicator

- Descale:**
1. Place Saeco descaler into fresh water tank.
 2. Fill with about one litre of hot water.
 3. Remove about two to three cups via the brewing unit.
 4. Confirm the Descale item in the user menu by pressing twice the E-button (place a sufficiently large container under the hot water pipe). The descaler mixture is pumped at intervals through the circuit.
 5. Rinse: Fill the water tank once again and press the E-button twice (about 2 cups via brewing unit).

Reset: Under the descale indicator item Enter - YES - Enter.

Troubleshooting		
Fault/Indicator	Possible cause	Remedy
Does not function	No power	Check mains plug / mains circuit breaker / Ensure machine door is closed.
BREWING UNIT NOT DETECTED	Brewing unit not properly installed or not closed.	Install brewing unit correctly.
GRINDS CONTAINER NOT DETECTED	Coffee grinds container not properly installed.	Brewing unit correctly installed.
COFFEE BEAN CONTAINER EMPTY	Coffee bean container is empty.	Fill coffee container. Reset: Enter button
FILL WATER DE-AERATE	Water tank is empty.	Water tank
OVERHEATING	After steam dispensing the system is not or is insufficiently de-aerated.	De-aerate machine.
GRINDER OBSTRUCTED		Clean grinder.
DE-AERATE	Air in water system.	Press hot water button.
Instead of coffee, only water is dispensed.	Coffee powder selection button is pressed, but no coffee powder is dispensed.	Add one level measure of coffee powder.
No water / steam	Steam nozzle blocked.	Free opening using a thin needle.

Attention: The coffee beans low indicator must be reset (**keep the enter button pressed for a minimum of 5 sec.**).

Troubleshooting		
Fault/Indicator	Possible cause	Remedy
The coffee flows too quickly	Beans ground too coarsely.	Select lower grind level; e.g. change from 5 to 3.
The coffee flows too slowly	Beans ground too finely.	Select higher grind level; e.g. change from 5 to 7.
Coffee is not hot enough	The cups are cold.	Pre-heat cups.
	Boiler temperature too low.	Increase temperature in user programme.
Coffee has no froth.	Unsuitable coffee blend.	Change brand of coffee.
	Coffee is no longer freshly roasted.	Use fresh coffee.
	Beans ground too coarsely or finely.	Change grind level.
Longer heating time or less hot water.	The machine is calcified.	Decalcify machine.
The brewing unit cannot be removed.	The brewing unit is not in home position.	Turn machine on, close service door and check dregs drawer. (the brewing unit goes automatically to home position)

5.2. User programme (Royal Office):

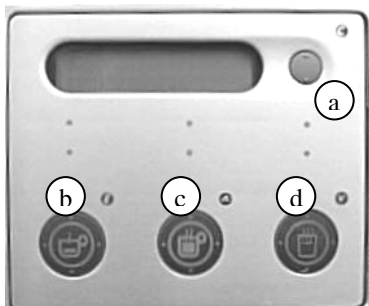

Access programming by keeping the V (hot water) and C (Esc) buttons pressed and switching the machine on from the main switch.

- (a) C button ESC – Return to previous programme level.
- (b) E button ENT – Espresso. To select and save a value entered.
- (c) ↑ button UP – Coffee. Scroll in menu and change value.
- (d) ↓ button DOWN – Hot water. Scroll in menu and change value.

When entering the code or PUC code, the buttons have the following value:

- E = Espresso = 1
- ↓ = Coffee = 2
- ↑ = Hot water = 3
- C = ESC = 4

Item	Setting/Indicator	Standard	Function
Code		111111	Programme protection If the code is entered five times incorrectly, the PUC code must be entered. Request from Saeco Austria.
Vending			The counter can be read and locking function activated via the vending menu.
Language	Country	German	Display language
Rinse	ON/OFF	OFF	Rinses every time the machine is turned on (temp. of instantaneous water heater < 50°C)
Water hardness	1 – 500 l	3	Change in coffee quantity until descaling required (1-4).
	2 – 300 l		
	3 – 150 l		
	4 – 80 l		
Temperature (Espresso)	Maximum	Medium	Adjustment of espresso temperature.
	High		
	Medium		
	Low		
	Minimum		

Item	Setting/Indicator	Standard	Function
Temperature (Coffee)	Maximum	Medium	Adjustment of coffee temperature.
	High		
	Medium		
	Low		
	Minimum		
Pre-brewing	ON	ON	Coffee is moistened before actual brewing (better aroma)
	LONG		
	OFF		
Pre-grinding	ON/OFF	OFF	Pre-grinds the next coffee dose.
Quantity programme	ON/OFF	OFF	Locking or releasing of quantity programme
Descale			Activate descaling programme Duration: Approx. 45 min
Scale indicator	YES/NO		Counter reset (only if descaling indicator is activated).
Timer	0-12.45 hours	0	Machine switches to standby mode if not used within the programmed time. (Standby mode can also be activated at any time via the menu buttons.)
Cleaning cycle			No relevant in Austria

5.3. Vending menu:

Access: In user menu (C+Espresso button+turn on machine), enter code and confirm item Vending with the E-button.

Vending menu		
Item	Indication	Comments
Reset counter		Reset: Espresso counter Coffee counter Hot water counter Cycle counter
1 espresso Total Number	Number of espressos dispensed since last reset	
1 coffees Total Number	Number of coffees dispensed since last reset	
Hot water Total Number	Number of hot water portions dispensed since last reset	
Counter Cycles Number	Counts the coffees dispensed since last reset and locks machine for coffee dispensing when a specific number is reached	
Counter Lock: Number	Number of coffees dispensed	Programmable via arrow buttons
Total coffee Total: Number	Number of total coffees dispensed	Not resettable
Beverages Total Number	Number of total beverages dispensed	Not resettable
Action	Procedure	Display
Change code		
Access	Confirm vending in user menu via ENTER.	Reset counter
Call up code entry	Press up arrow once	*****
Call up code entry	Confirm with E-button	Change code / Old code? *****
Call up code entry	Old code by: Espresso button = 1 Coffee button = 2 Hot water button = 3 C-button = 4 Enter and confirm with E-button.	Change code / Old code? *****
Code entry	New code by: Espresso button = 1 Coffee button = 2 Hot water button = 3 C-button = 4 Enter and confirm with E-button.	New code? *****

	Action	Procedure	Display
	Change code		
	Code entry	Enter required number combination by using the arrow and enter buttons	New code = number Save No
	Confirm code	Use arrow button to select Yes	New code = number Save Yes
	Confirm code	Press ENTER	Code *****
	Exit	Press C-button twice	

Attention: If you forget the code, a new code must be requested from Saeco Austria!

CHAPTER 4

FUNCTIONS AND TIMING

	Page
1. Water system	1
1.1. WSP (R. Classic/Digital/ Exclusive/Digit. Redes)	1
1.2 WSP (Digital Plus)	2
1.3. WSP (R. Prof. Rapid Steam/Prof. Red.)	3
1.4. WSP (R. Cappuccino/Prof. Instant Steam)	4
1.4. WSP (R. Cappuccino Redesign)	6
1.4. WSP (R. Coffeabar)	9
1.5. WSP (R..Office)	11
2. Electrical system	8
2.1.1. CPU – IN / OUT (R. Classic)	12
2.2.1. CPU – INPUT (Royal Digital/Exclusive)	13
2.2.2. Control panel (Royal Digital/Exclusive)	14
2.3.1. CPU – INPUT (Cappuccino/Professional Instant Steam)	15
2.3.2. Control panel (Cappuccino/Professional Instant Steam)	16
2.4.1. CPU – INPUT (R. Profess. Rapid Steam / Coffeabar)	17
2.4.2. Control panel (R. Profess. Rapid Steam / Coffeabar)	18

1. Water system

1.1. Water system (Royal Classic / Digital / Exclusive / Digital Redesign)

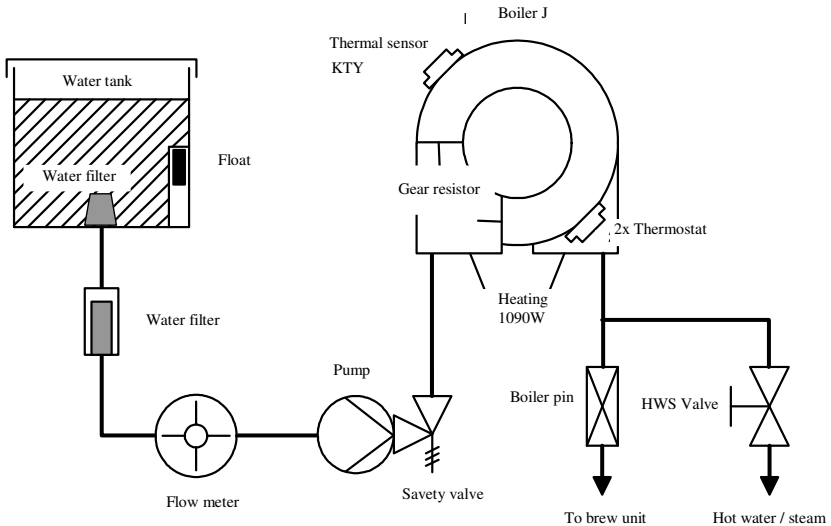

Component	Function
Water tank	Water supply
Float	Water level monitoring
Water filter	Water cleaned of solid matter (one or two depending)
Flow meter (turbine)	Measure flow rate
Pump	Water flow/Pressure build-up (13 to 15 bar)
Safety valve	Protect boiler against overpressure (opens at 17 bar)
Boiler (flow heater)	Heats water to approx. 84°C (for brewing process)
Sensor (KTY)	Transmits current temperature value to electronic system
Thermostat	Interrupts complete flow supply if overheating.
Boiler pin (Valve plug)	Opens when brewing unit is aligned with water circuit to the unit itself.
HWS valve	For hot water and steam dispensing

1.2. Water system (Royal Digital Plus)

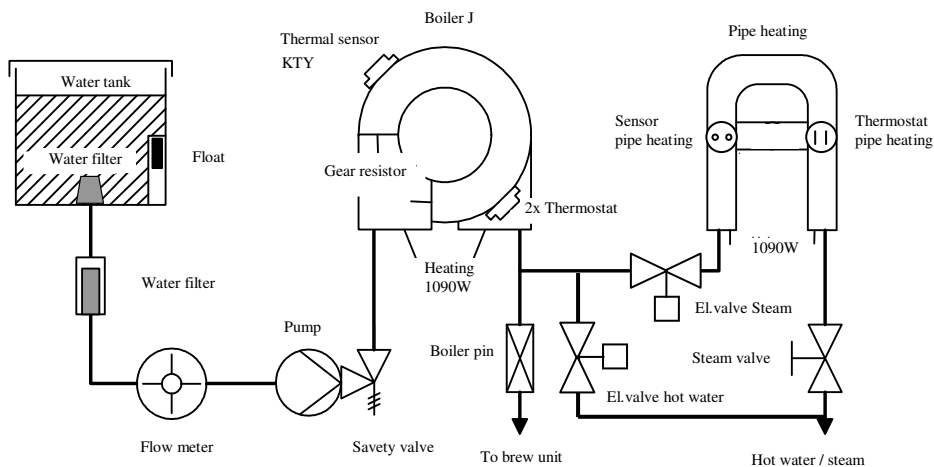

Component	Function
Water tank	Water supply
Float	Water level monitoring
Water filter	Water cleaned of solid matter (one or two depending)
Flow meter (turbine)	Measure flow rate
Pump	Water flow/Pressure build-up (13 to 15 bar)
Safety valve	Protect instantaneous water heater against overpressure
Instantaneous water heater/Heating (coffee/hot water)	Heats water to approx. 94°C (for brewing process and hot water preparation)
Pipe heating	Steam generation / Temperature approx. 130°C
Sensor (KTY)	Transmits current temperature value to electronic system
Instantaneous water heater	
Thermostat (170°C)	Alternates current supply for heating system in event of overheating.
Instantaneous water heater	
Sensor (KTY)	Transmits current temperature value to electronic system
Pipe heating	
Thermostat (170°C)	Alternates current supply for heating system in event of overheating.
Pipe heating	
Boiler pin (Valve plug)	Opens when brewing unit is aligned with water circuit to the unit itself.
Steam valve	For hot water and steam dispensing
Electro-valve (hot water)	Solenoid valve for water dispensing
Electro-valve (for boiler filling)	Solenoid valve for filling pipe heating system

1.3. Water system (Royal Professional Rapid Steam / Professional Redesign)

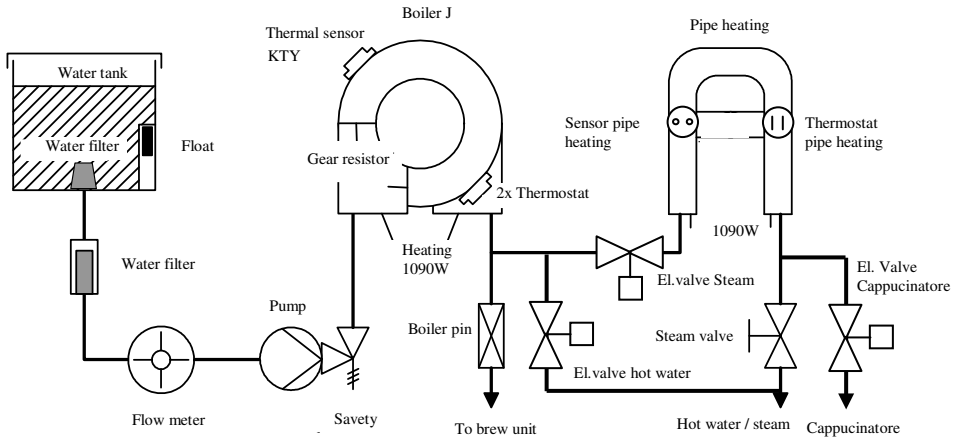

Component	Function
Water tank	Water supply
Float	Water level monitoring
Water filter	Water cleaned of solid matter
Flow meter (turbine)	Measure flow rate
Pump	Water flow/Pressure build-up (13 to15 bar)
Safety valve	Protect instantaneous water heater against overpressure
Instantaneous water heater/Heating (coffee/hot water)	Heats water to approx. 94°C (for brewing process and hot water preparation)
Pipe heating	Steam generation / Temperature approx. 130°C
Sensor (KTY) Instantaneous water heater	Transmits current temperature value to electronic system
Thermostat (170°C) Instantaneous water heater	Alternates current supply for heating system in event of overheating.
Sensor (KTY) Pipe heating	Transmits current temperature value to electronic system
Thermostat (170°C) Pipe heating	Alternates current supply for heating system in event of overheating.
Boiler pin (Valve plug)	Opens when brewing unit is aligned with water circuit to the unit itself.
Steam-valve	For hot water and steam dispensing
Electro-valve (for cappuccino maker)	Solenoid valve/steam dispensing for cappuccino
Electro-valve (water)	Solenoid valve for water dispensing
Electro-valve (steam)	Solenoid valve for filling pipe heating system

1.4. Water system (Royal Cappuccino / Professional Instant Steam)

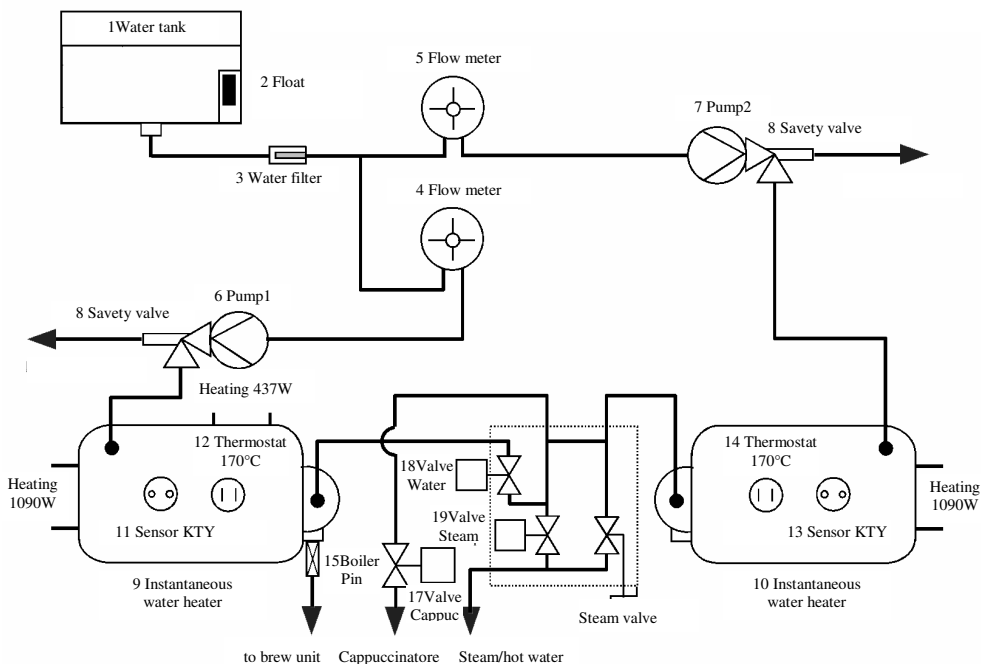

	Component	Function
1	Water tank	Water supply
2	Float	Water level monitoring
3	Water filter	Water cleaned of solid matter
4	Flow meter (turbine) System 1	Measure flow rate
5	Flow meter (turbine) System 2	Measure flow rate
6	Pump System 1	Water flow/Pressure build-up (13 to 15 bar)
7	Pump System 2	Steam dispensing/Pressure build-up (13 to 15 bar)
8	Safety valve	Protect instantaneous water heater against overpressure (opens at 17 bar)
9	Instantaneous water heater/Heating (coffee/hot water)	Heats water to approx. 94°C (for brewing process and hot water preparation)
10	Instantaneous water heater/Heating (steam)	Steam generation / Temperature approx. 130°C
11	Sensor (KTY) System 1 (Water)	Transmits current temperature value to electronic system
12	Thermostat System 1 (Water)	Alternates current supply for heating system in event of overheating.

	Component	Function
13	Sensor (KTY) System 2 (steam)	Transmits current temperature value to electronic system
14	Thermostat System 2 (steam)	Alternates current supply for heating system in event of overheating.
15	Boiler pin (Valve plug)	Opens when brewing unit is aligned with water circuit to the unit itself.
16	Steam valve	For steam dispensing
17	Valve cappuccinatore (for cappuccino maker)	Solenoid valve/steam dispensing for cappuccino
18	Valve (water)	Solenoid valve for water dispensing
19	Valve (steam)	Solenoid valve for steam dispensing (turbowater)

1.5. Water system (Royal Cappuccino Redesign)

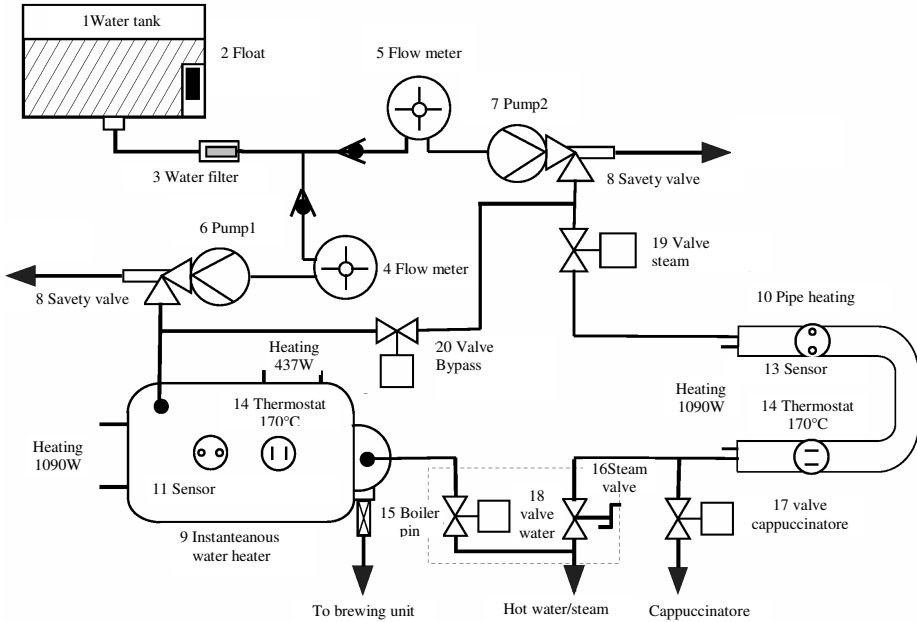

	Component	Function
1	Water tank	Water supply
2	Float	Water level monitoring
3	Water filter	Water cleaned of solid matter
4	Flow meter System 1	Measure flow rate
5	Flow meter System 2	Measure flow rate
6	Pump System 1	Water flow/Pressure build-up (13 to 15 bar)
7	Pump System 2	Steam dispensing/Pressure build-up (13 to 15 bar)
8	Safety valve	Protect instantaneous water heater against overpressure (opens at 17 bar)
9	Instantaneous water heater/Heating (coffee/hot water)	Heats water to approx. 94°C (for brewing process and hot water preparation)
10	Pipe heating / Heating (steam)	Steam generation / Temperature approx. 130°C
11	Sensor (KTY) System 1 (Water)	Transmits current temperature value to electronic system
12	Thermostat System 1 (Water)	Alternates current supply for heating system in event of overheating.

	Component	Function
13	Sensor (KTY) System 2 (steam)	Transmits current temperature value to electronic system
14	Thermostat System 2 (steam)	Alternates current supply for heating system in event of overheating.
15	Valve plug	Opens when brewing unit is aligned with water circuit to the unit itself.
16	Steam valve	For steam dispensing
17	Valve (for cappuccino maker)	Solenoid valve/steam dispensing for cappuccino
18	Valve (water)	Solenoid valve for water dispensing
19	Valve (steam)	Solenoid valve for steam dispensing (turbowater)
20	Valve (by-pass)	Solenoid valve for water dispensing

1. General functioning

The electromagnetic valve **EV1** is a by-pass valve located between **pump 2** and **pump 1**. It must be installed in the opposite direction to the flow.

When coffee and steam are dispensed simultaneously, a pressure difference exists between the two water circuits (up to 12 bar for the water system as opposed to 4 bar for the steam system), which enables the electromagnetic valve **EV1** to open.

In the event of a fault, very humid steam and inconsistent coffee quantities are obtained since the quantity of water, determined by **Turbine 1**, does not completely reach the coffee/steam system.

2. Simultaneous coffee and steam dispensing

- Solenoid valve **EV1**: Closed
- Solenoid valve **EV2**: Open
- Solenoid valve **EV3**: Closed
- Solenoid valve **EV4**: Closed or open, depending on whether the steam is dispensed via the Cappamore or the rotary valve.
- **Pump 1** functions for coffee production, while **pump 2** pulses the steam.

3. Simultaneous hot water and steam dispensing

- Solenoid valve **EV1**: Closed
- Solenoid valve **EV2**: Open
- Solenoid valve **EV3**: Open
- Solenoid valve **EV4**: Closed or open, depending on whether the steam is dispensed via the Cappamore or the rotary valve.
- **Pump 1** functions for hot water production, while **pump 2** pulses the steam.

4. Dispensing only hot water

- Solenoid valve **EV1**: Open
- Solenoid valve **EV2**: Closed
- Solenoid valve **EV3**: Open
- Solenoid valve **EV4**: Closed
- **Pump 2** functions to produce hot water. This ensures that both pumps are regularly flushed with water and no damage is caused by standing dry for too long.

5. Automatic descaling

Stage 1)

- Solenoid valve **EV1**: Closed
- Solenoid valve **EV2**: Open
- Solenoid valve **EV4**: Open
- 55 pulses are generated via **pump 1** and 55 pulses via **pump 2**.

Stage 2)

- Solenoid valve **EV1**: Open
- Solenoid valve **EV2**: Closed
- Solenoid valve **EV3**: Open
- 30 water pulses are generated via **pump 2**.

Stage 3)

- Solenoid valve **EV1**: Closed
- Solenoid valve **EV2**: Open
- One minute pause is allowed for the descaling solution to take effect. All solenoid valves, **EV1-2-3-4** are open to prevent an increased pressure in the water system caused by the descaling solution.

All three processes are repeated several times automatically (about 45 minutes).
A final rinse with no descaling solution must be performed.

1.6. Water system (Royal Coffeebar)

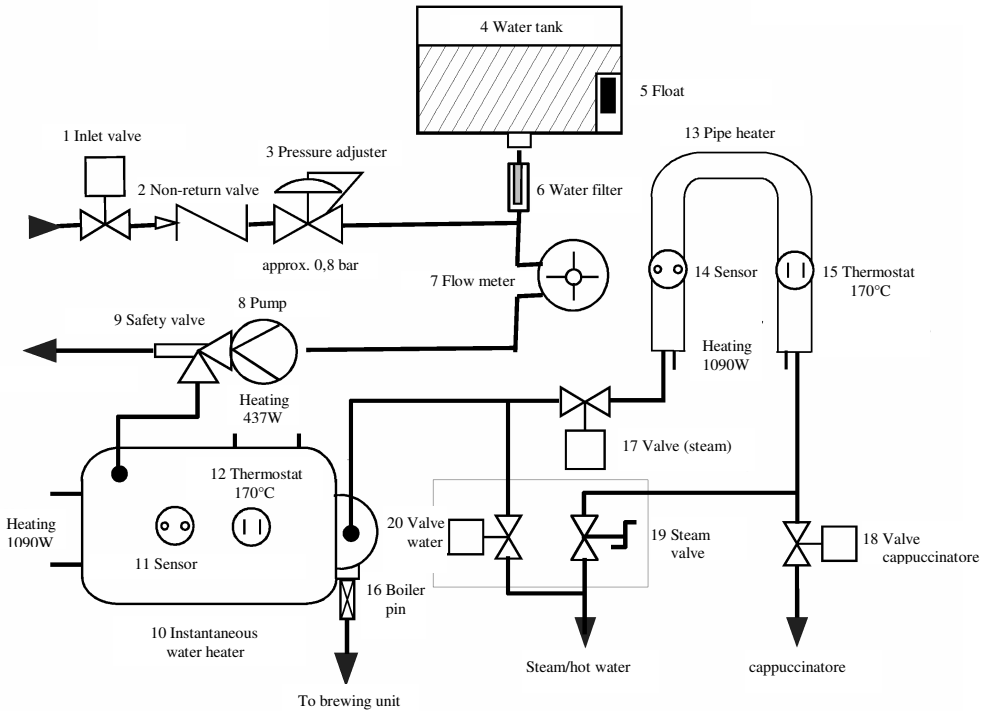

	Component	Function
1	Inlet valve	Activates external water supply
2	Non-return valve	
3	Pressure adjuster	Reduces the water circuit pressure to about 0.8 bar
4	Water tank	Water supply
5	Float	Water level monitoring
6	Water filter	Water cleaned of solid matter
7	Flow meter (turbine)	Measure flow rate
8	Pump	Water flow/Pressure build-up (13 to 15 bar)
9	Safety valve	Protect instantaneous water heater against overpressure
10	Instantaneous water heater/Heating (coffee/hot water)	Heats water to approx. 94°C (for brewing process and hot water preparation)
11	Sensor (KTY) Instantaneous water heater	Transmits current temperature value to electronic system
12	Thermostat Instantaneous water heater	Alternates current supply for heating system in event of overheating.
13	Pipe heating	Steam generation / Temperature approx. 130°C

	Component	Function
14	Sensor (KTY) Pipe heating	Transmits current temperature value to electronic system
15	Pipe heating thermostat	Alternates current supply for heating system in event of overheating.
16	Valve plug	Opens when brewing unit is aligned with water circuit to the unit itself.
17	Valve (for boiler filling)	Solenoid valve for filling pipe heating system
18	Valve (Cappumore)	Solenoid valve/steam dispensing for Cappumore
19	Valve (steam)	For hot water and steam dispensing
20	Valve (water)	Solenoid valve for water dispensing

Note: In the Royal Coffeebar it is possible to operate the machine directly from the fixed water connection. The inlet valve is activated via the user programme (Chap. 3, Page 16).
A pressure reducer installed at the inlet point maintains an almost pressureless operation before the pump.
However, a separate flow meter is used to measure the flow rate.

1.7. Water system (Office)

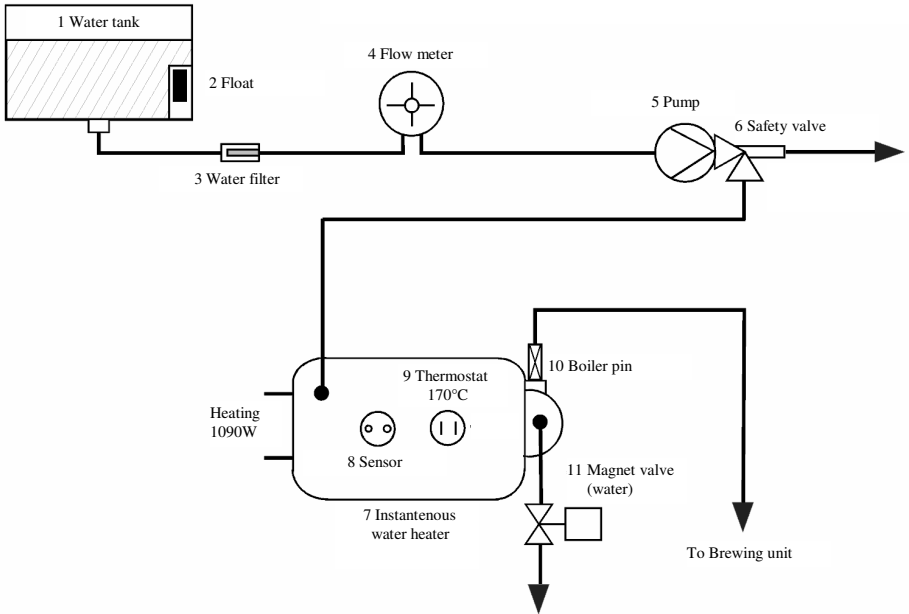

	Component	Function
1	Water tank	Water supply
2	Float	Water level monitoring
3	Water filter	Water cleaned of solid matter
4	Flow meter (turbine)	Measure flow rate
5	Pump	Water flow/Pressure build-up (13 to 15 bar)
6	Safety valve	Protect instantaneous water heater against overpressure (opens at 17 bar)
7	Instantaneous water heater/Heating	Heats water to approx. 94°C (for brewing process)
8	Sensor (KTY)	Transmits current temperature value to electronic system
9	Thermostat	Alternates current supply for heating system in event of overheating.
10	Valve plug	Opens when brewing unit is aligned with water circuit to the unit itself.
11	Magnet valve (water)	Solenoid valve for water dispensing

2. Electrical system

2.1. CPU – IN / OUT (Royal Classic)

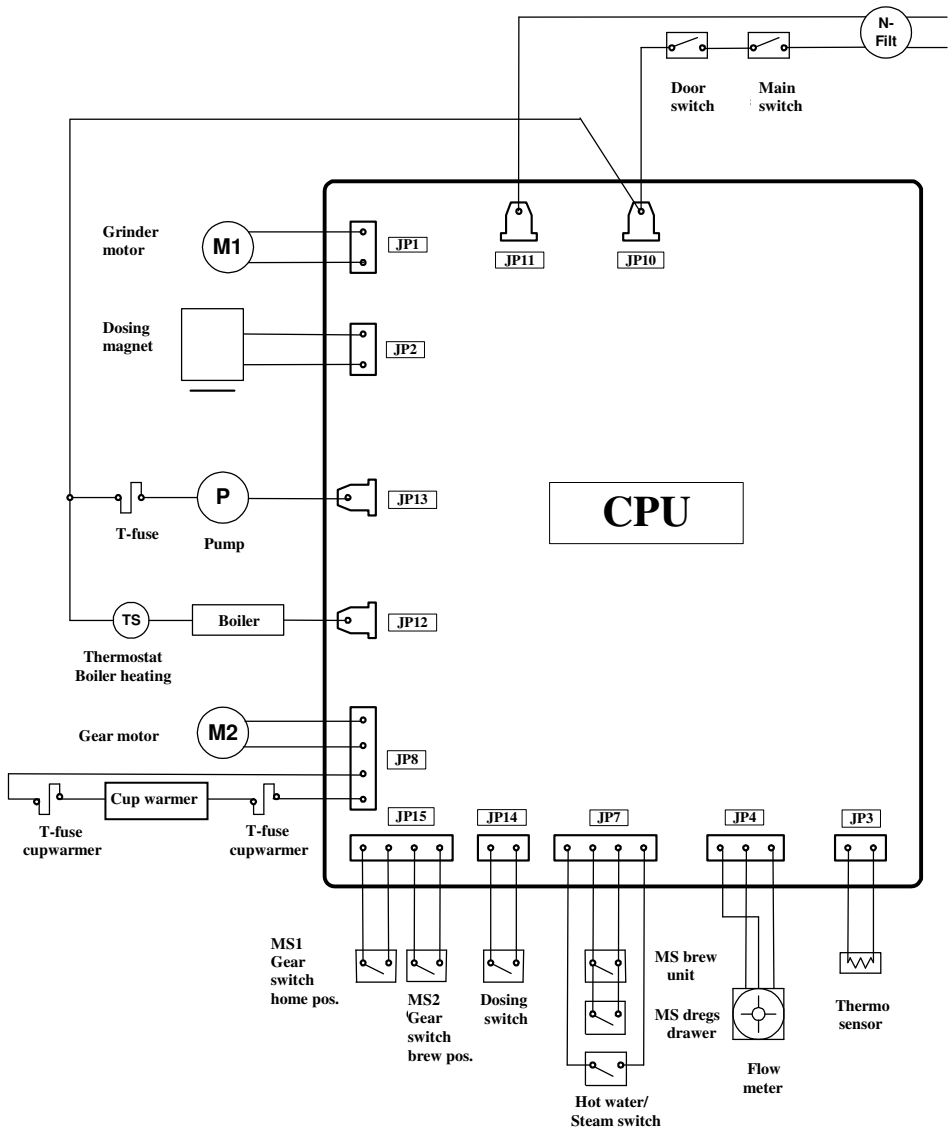

2.2.1. CPU – INPUT (Royal Digital / Exclusive)

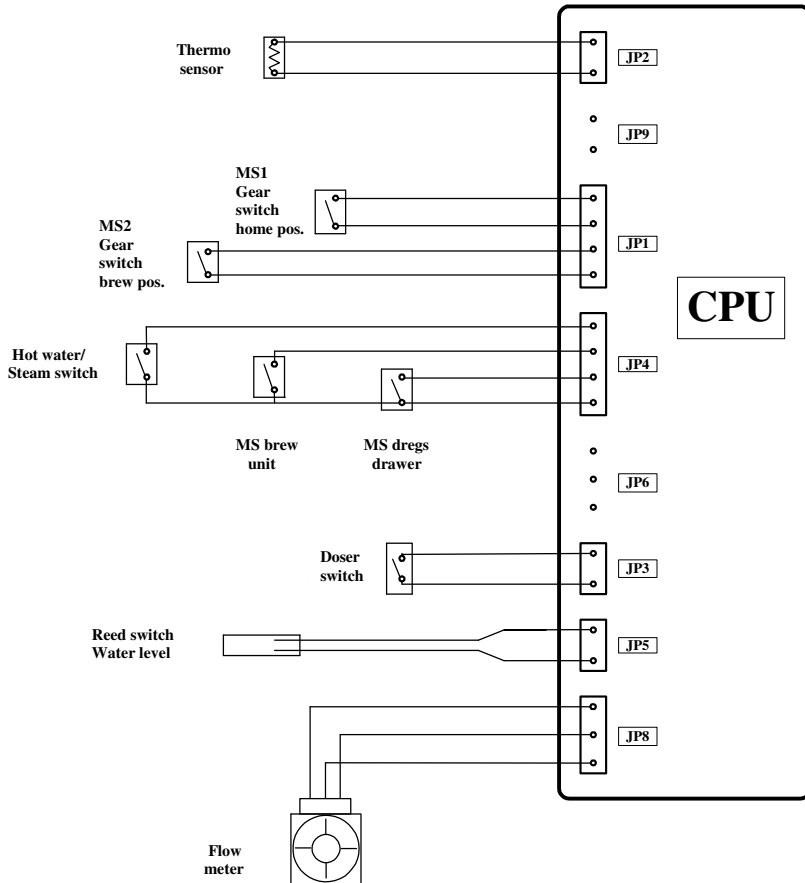

Component	Voltage	Comments
Microswitch MS1	15/5V =	Gears in home position
Microswitch MS2	15/5V =	Gears in brewing position
Microswitch MS3	15/5V =	Brewing unit
Microswitch MS4	15/5V =	Doser
Microswitch MS5	15/5V =	HWS valve
Microswitch MS6	15/5V =	Dregs drawer

2.2.2. Control panel (Royal Digital / Exclusive)

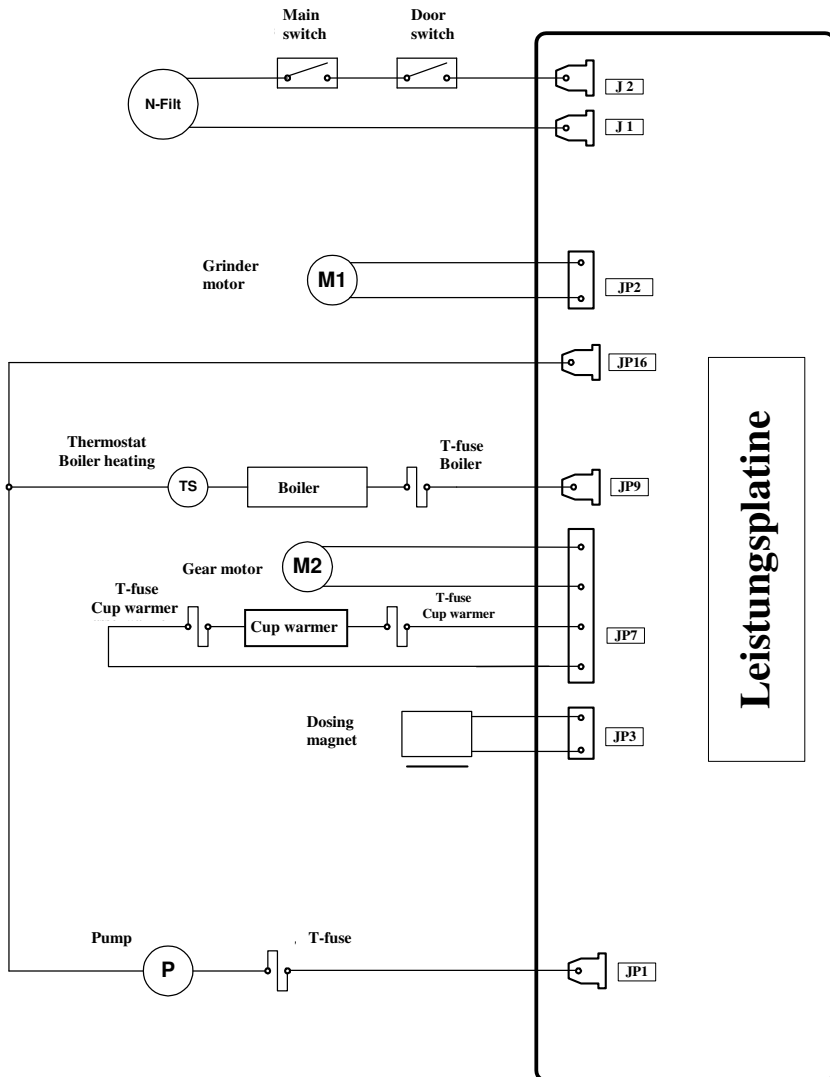

Pump	Approx. 190V~	Diode in pump
Mains switch	230 V~	
Door microswitch	230 V~	
Doser coil	230 V~ / 300Ohm	
Microfuse F1	230 V~ / 8AT	

2.3.1. CPU – INPUT (Royal Cappuccino / Professional Instant Steam)

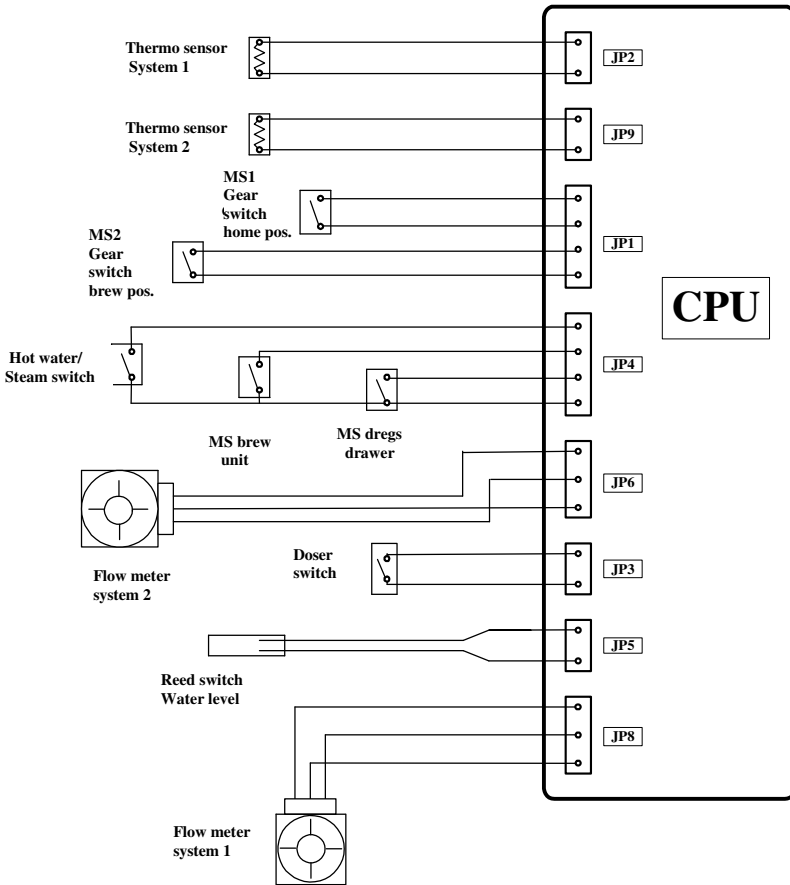

Component	Voltage	Comments
Microswitch MS1	15/5V =	Gears in home position
Microswitch MS2	15/5V =	Gears in brewing position
Microswitch MS3	15/5V =	Brewing unit
Microswitch MS4	15/5V =	Doser
Microswitch MS5	15/5V =	HWS valve
Microswitch MS6	15/5V =	Dregs drawer

2.3.2. Control panel (Royal Cappuccino / Professional Instant Steam)

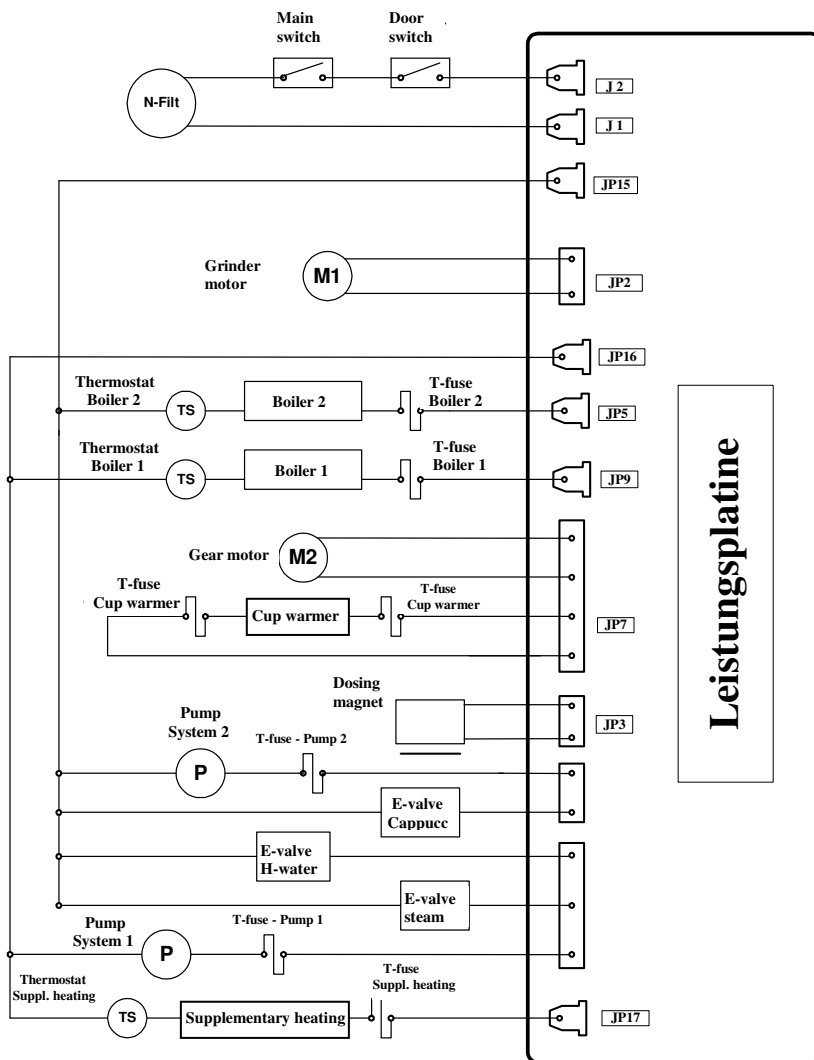

Microfuse F1	230 V~ / 32mAT	Control
Microfuse F2	230 V~ / 8AT	Pipe heating
Microfuse F3	230 V~ / 8AT	Instantaneous water heater

2.4.1. CPU – INPUT (Royal Professional Rapid Steam / Royal Coffeebar)

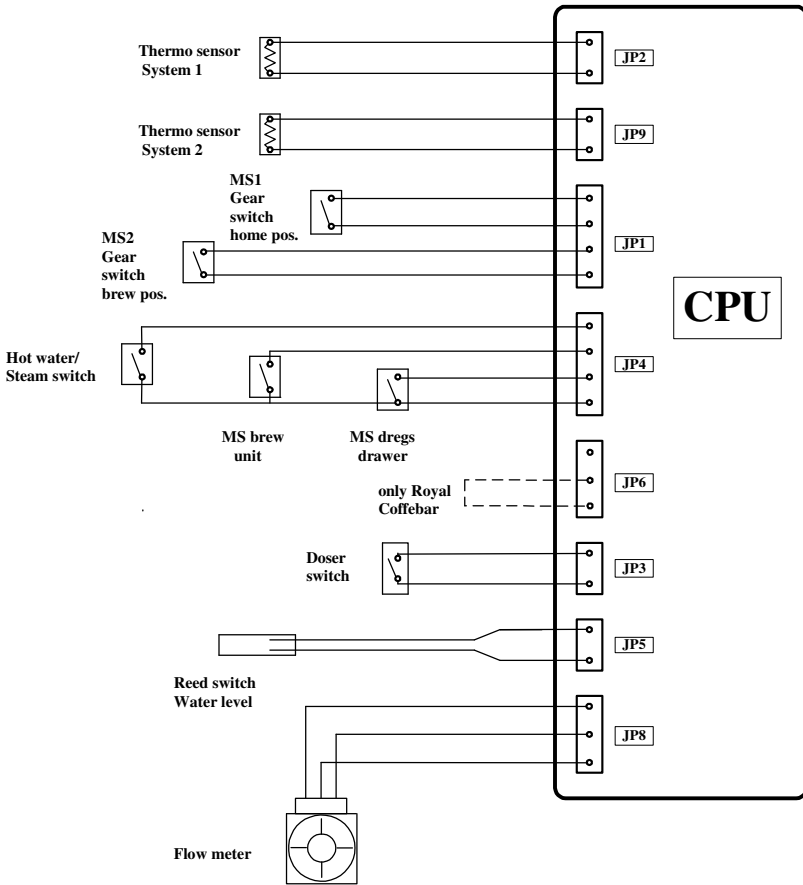

Component	Voltage	Comments
Microswitch MS1	15/5V =	Gears in home position
Microswitch MS2	15/5V =	Gears in brewing position
Microswitch MS3	15/5V =	Brewing unit
Microswitch MS4	15/5V =	Doser
Microswitch MS5	15/5V =	HWS valve
Microswitch MS6	15/5V =	Dregs drawer

2.4.2 Control panel (Royal Professional Rapid Steam / Royal Coffeebar)

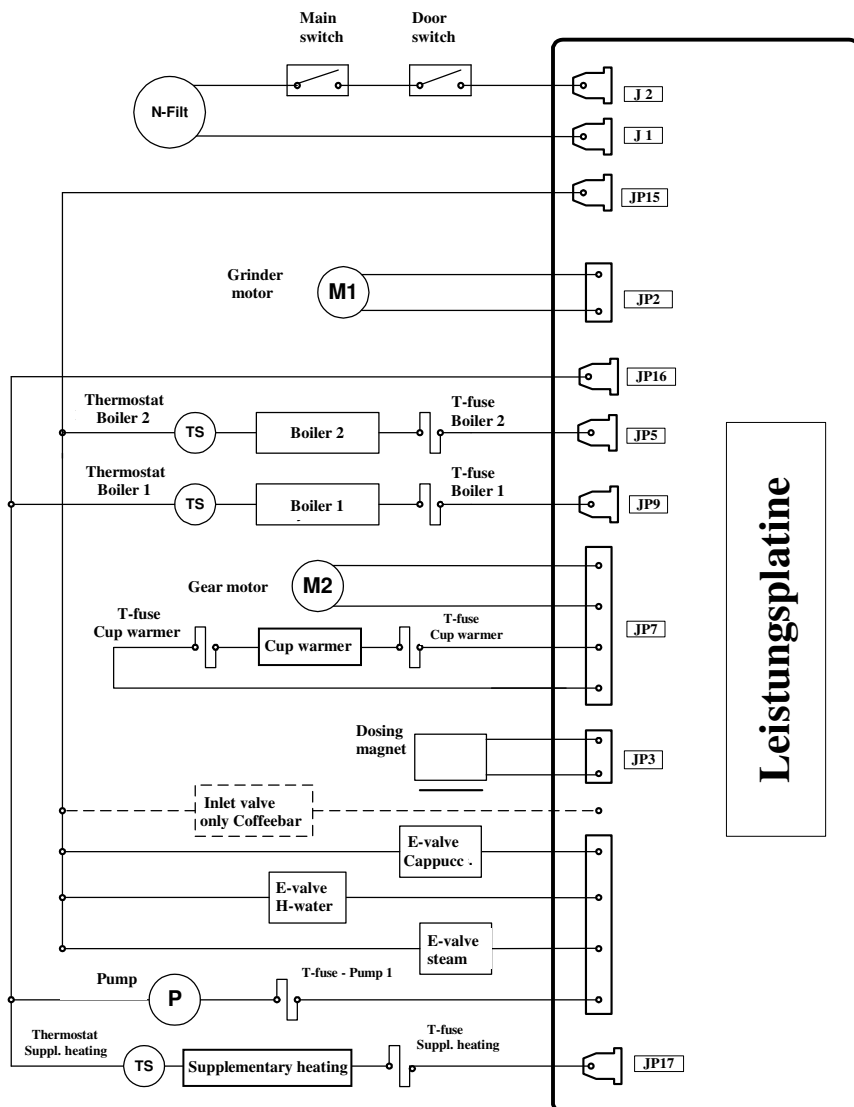

Microfuse F1	230 V~ / 32mAT	Control
Microfuse F2	230 V~ / 8AT	Pipe heating
Microfuse F3	230 V~ / 8AT	Instantaneous water heater

3. Timing

The following time chart indicates the functions of the individual components in terms to time (excluding Royal Classic, see process for Vienna)

Grinder motor			app.5.5sec	
Doser				
Heating	app. 1.5 min			
Pump			*	depending on coffee qty
Gear motor	down up		up	down up
Status	Heating stage	Stand by	Coffee dispensing process	

Note : * Only in machines with pre-brewing systems

Explanation:

Two processes start when the main switch is activated:

Firstly, the gearmotor is initialised. The gears move to MS1 (lower limit switch), change rotating direction, leave MS1 and move to the home position (about 2 mm after MS1). **Exception:** Royal Classic – process as for Vienna (moves to brewing position and back / see Vienna).

The instantaneous water heater is then activated for about 1 min 30 sec., heating the water to operating temperature, whereby heating takes place for about 60 sec. continuously and then is alternated for the rest of the time.

After activating the start button:

1. The grinder starts operating (about 5.5 sec.).
2. The doser is activated twice.
3. The gears move to brewing position.
4. Depending on the type of machine, pre-brewing begins (brief pump activation).
5. Main brewing process (duration of pump activation depending on selected coffee quantity).
6. The gears move to home position (dregs are discarded).

Note:

If the machine is disconnected from the main power supply during operation (power failure/side doors opened), the gears will complete the function commenced but without brewing (if the interruption occurs before brewing, the coffee will be dispensed dry).

If operation is interrupted by removal of the dregs drawer, the machine will continue its function unrestricted once the drawer is returned.

4. Function

4.1. Gearmotor

The gearmotor is a direct current motor and is controlled by the CPU at approx. 30 – 35 V.

In order to perform forwards and backwards movements, the gearmotor is controlled alternately with a positive and negative half wave.

In the event of overload the motor's electronic system switches off after 8-10 sec. and the machine is stopped. This situation is indicated by the flashing fault LED. In digital display indicator systems: brewing unit locked.

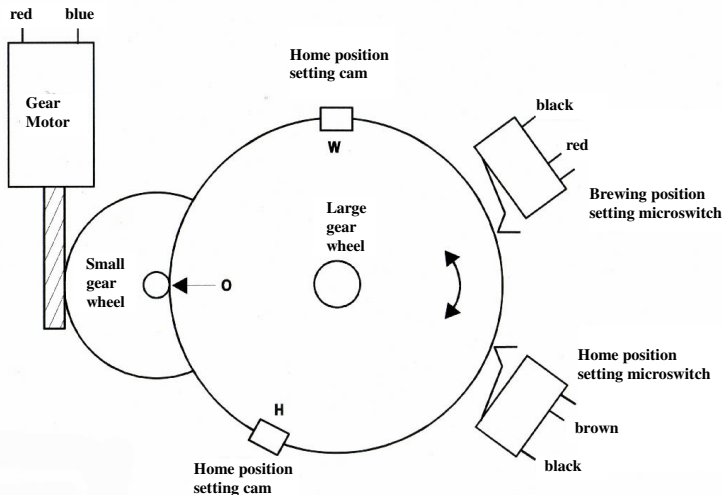

Important: During installation of the large gear wheel care must be taken that the marking on the large gear wheel always faces the direction of the small gear wheel axis, and that both limit switches are positioned in the larger segment between both switching cams.

If the motor is replaced, it is important that the blue cable (-) is fitted onto the motor connection near the writing "Italy" (+ and - are not marked).

4.2. Heating plate (Gear resistor)

The heating plate is operated with a wave packet control system. The ratio of the power-on time is approx. 1:40 (0.1 sec on, 3.9 sec. off). The heating plate is activated via the corresponding item in the user menu. It is only active when the machine is not operational. The heating plate output is approx. 437 W.

In order to reduce the total power output of the machine, the heating plate is turned off during the heating stage.

The heating plate can act as a resistor for the gearmotor.

In the event that several coffees are brewed consecutively, the heating plate warms up without being turned on. The heating plate is protected against overload by 2 thermal fuses.

If one of the thermal fuses is compromised or the heating plate is defective, the gearmotor also does not function.

Exception: The Royal Office does not have a heating plate. The gear resistor is the small resistor on the instantaneous water heater.

4.3. Water level indicator

The water level in the water tank is monitored by a float fitted with a magnet core. If the water level is too low, the magnet is no longer within the range of the reed contact, which transmits the low water level signal to the CPU.

4.4. Flow meter (Turbine)

The machine is also equipped with a flow rate monitoring system. The system checks whether the water monitoring flow meter (turbine) turns. If no pulses are generated from the flow meter within 10 seconds, the current cycle is interrupted. The fault is indicated by the water low indicator (machine without float) or by the de-aerate indicator in machines with float (reed sensor). If this control mechanism is activated, the machine must be de-aerated. During these signals, the pump operates at maximum output. As soon as the pump has created sufficient flow, the pump output is reduced to approx. 20 l/hr. The water quantity is generally controlled according to the coffee quantity programmed through the flow meter (turbine) pulses.

4.5. HWS valve (steam operation)

The HWS valve is required for water and steam dispensing, as well as during de-aeration.

If the hot water valve is opened during brewing, the coffee flow is interrupted and the Water Low indicator begins to flash or the message Close Dial appear on the display. As soon as the hot water valve is closed, the brewing process will continue (**only in machines without Instant Steam**).

The operating temperature during steam dispensing is approx. 125°C. The steam button is pressed to activate steam production (in machines without Rapid or Instant Steam). Steam dispensing occurs via the HWS valve.

In machines with Rapid Steam, the steam can be dispensed immediately after the end of the coffee cycle (second instantaneous water heater).

In machines with Instant Steam, the steam or cappuccino can be dispensed even during the coffee cycle. The pump pulses the steam dispensed. This means that constant steam dispensing is ensured over a long period of time. The flow rate of the pump is adjusted on the basis of the thermoblock temperature. If the temperature is too low, the pump pulses are slowed down. This may occur, for instance, when the hot water valve opens before the temperature indicator lights up.

In machines with Instant Steam, the steam is added during hot water dispensing in order to reach an even higher water temperature. The flow volume can be adjusted under the items HOT WATER or TURBOWATER (when System 2 is turned on).

Once the steam has been dispensed, the steam valve closes and the steam button must be pressed for normal operating mode. The steam and coffee temperature indicators flash or the message OVERHEATING appears in machines with digital display, until the machine has cooled and the machine cannot dispense coffee. Cooling can be achieved by dispensing hot water. The pump functions at maximum output and the heating remains turned off as long as the temperature indicator flashes (R. Classic) / Overheating signal remains on (Royal Digital/Exclusive). These measures ensure that the cooling process is accelerated and the overheating signal will disappear after a few seconds (**only in machines without Instant or Rapid Steam**).

4.6. Temperature sensor (KTY 10)

The temperature sensor is a temperature-sensitive resistance mechanism, converting the instantaneous water heater temperature into an electrical signal which is measurable by the CPU.

The CPU compares this signal with the programmed reference signal and, depending on the outcome of the comparison, controls the instantaneous water heater output.

The resistance applied has a positive temperature coefficient; i.e. higher instantaneous water heater temperature - higher sensor resistance.

The table below indicates the trend in resistance values in relation to the temperature.

Measured values:

Temperature	Resistance (Ω)	Resistance trend (Ω)
0	1629	0
15	1845	216
20	1922	77
40	2246	324
90	3168	922
100	3366	198
130	3979	613
140	4188	209

At room temperature the resistance is 1.9K Ω .

4.7. Grinder

The grinder is a conical grinder with upper and lower grinding disc. The grind level is set by adjusting the height of the upper grinding disc by means of the screw thread.

If the grinding discs are drawn apart by turning the grind level adjusting ring (turning anti-clockwise), the grind is coarser, while turning the adjusting ring clockwise will result in a finer grind.

ATTENTION: Adjust the grind level only when the grinder is in operation!

The grinder operates with a direct current motor and the grinding disc rotation speed is determined by a gearmotor. The grinder motor operates with a voltage of 260 V.

4.8. Doser

The coffee quantity for the current coffee process is portioned (dosed) in the doser chamber; a higher dose results in a stronger (more concentrated) coffee. A lower dose results in a weaker (less concentrated coffee). The doser is controlled by a microswitch. The ground coffee is pressed into the doser chamber from the grinder. When the dosing chamber is full, the microswitch is activated and transmits to the CPU the signal to turn the grinding motor OFF.

Grinding is stopped, the dosing magnet engages (2x), opens the dosing flap and the coffee falls into the brewing unit.

If the dosing microswitch is not activated within 20 seconds from start of the grinder motor, the coffee beans low signal appears.

The dosing quantity is set automatically by shifting the doser housing wall together with its microswitch.

CHAPTER 5

SERVICE PROGRAMME

	Page
1. Service programme (R. Classic)	1
1.1. Test mode	1
2. Service programme (Royal Digital/Exclusive/Digital Redes.)	2
2.1. Test mode	2
2.2. Diagnosis menu	5
3. Service programme (Professional Instant Steam/Cappuccino/ Cappuccino Redesign)	7
3.1. Test mode	7
3.2. Diagnosis menu	10
4. Service programme (R. Professional Rapid Steam/ Profess. Redes./Digital Plus/Coffeebar)	14
4.1. Test mode	14
4.2. Diagnosis menu	18
5. Service Programme (Royal Office)	21
5.1. Test mode	21
5.2. Diagnosis menu	23





1. Service programme (Royal Classic):

1.1. Test mode

Access: Access the service mode by turning on the machine and simultaneously pressing the Coffee and steam buttons.
Press Coffee and Steam buttons.

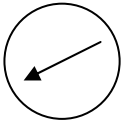
Various test functions can be activated in the service mode by activating either the coffee or steam buttons in conjunction with various coffee quantity settings.

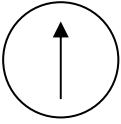
Programme table

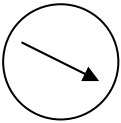
Function	Button	Control setting	LED Indicator
Pump/Turbine *	Coffee		Fault LED (flow meter pulses)
Brewing unit (Gearmotor) 	Steam		Coffee LED Gear switch (brewing setting)
Heating	Coffee		
Brewing unit (Gearmotor) 	Steam		Coffee LED Gear switch (home position)
Dosing magnet	Coffee		
Grinder	Steam		Steam LED Doser full
HWS microswitch			Steam LED

* The HWS valve must be open.

The current boiler temperature can be read in service mode by pressing the coffee and steam buttons at the same time.

Each combination of LEDs provides an indication on the current boiler temperature (see table below).

Temperature table

Temperature status	Coffee LED	Steam LED	Fault LED
T ≤ 94°C			X
T = 95°C	X		X
T = 96°C	X		
T = 97°C	X	X	
T ≥ 98°C		X	

2. Service programme (Royal Digital / Exclusive / Digital Redesign)

2.1. Test mode

Access (Royal Digital / Exclusive):

Access the test mode by turning on the machine and simultaneously pressing the coffee and steam buttons.

Keep the EXPRESSO and STEAM buttons pressed, whilst pressing the STANDBY button.

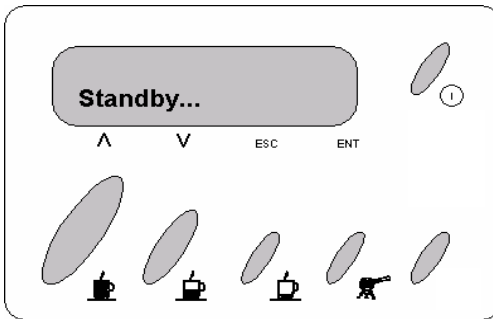

Access (Digital Redesign):

Access the service programme from the standby mode (Menu + Enter) by keeping the coffee, powder coffee and espresso buttons pressed, whilst pressing the Menu button. **(Important: Press the menu button only briefly to enter the service mode!)**

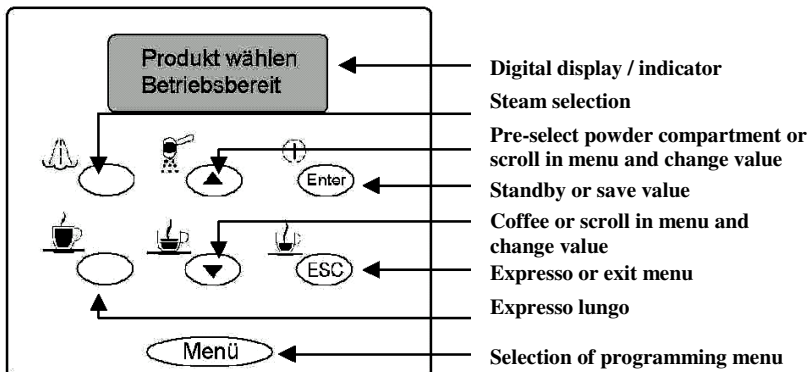

The various functions indicated in the table can be checked by pressing the button combinations listed below.

Programme table (test menu)

Royal Excl./Digital Buttons	S1 Espresso lungo	S2 Coffee	S3 Espresso	S4 Powder coffee	S5 Steam	S6 ON
Royal Digital Redes.	S1 Steam	S2 Powder coffee	S3 Espresso	S4 Espresso lungo	S5 Coffee	S6 Espresso
Unit up	x					
Unit down		x				
Grinder			x			
Pump	x					x
Doser				x		
Heating plate	x				x	
Heating		x			x	
Temperature indicator in °C				x	x	x

The upper display line signals the activated microswitch and the Hall effect of the flow meter.
The activated buttons are signalled by the lower display line (e.g. 1=S1, 2=S2, etc.).

All CPU input signals from the machine appear in the first line of the display.	All CPU input signals from the control board appear in the second line of the display.	
Royal Exclusive / Digital / Digital Redesign	Royal Excl. / Digital	Royal Digital Redesign
1 = Brewing unit in brewing position (brewing unit microswitch activated)	1 = Espresso lungo	1 = Steam
2 = Brewing unit in idle position (idle position microswitch activated)	2 = Coffee	2 = Powder coffee
3 = Doser chamber full (doser microswitch activated)	3 = Espresso	3 = Standby
4 = HWS valve microswitch activated	4 = Powder coffee	4 = Espresso lungo
5 = Grinds container microswitch activated	5 = Steam	5 = Coffee
6 = Brewing unit microswitch activated	6 = Standby	6 = Espresso
7 = Water tank filled (reed contact not activated)		7 = Menu
8 = Flow meter pulses (indicator flashes when magnet passes Hall generator)		

Flow rate

If the pump is activated during test mode and the hot water valve opened, a two-digit number appears at the bottom right side indicating the flow rate. This value must be between 40 - 60.

Grinder rate

If no button is activated, a number appears at the bottom right side referring to the grinder rate. This value must be between 125 - 135.

Exit: Switch the machine off from the main switch.

2.2. Diagnosis menu (Royal Digital / Exclusive / Digital Redesign)

The values below can be read and adjusted in the diagnosis menu as shown in the table.

Access: The following button combinations can be used in standby mode to access the diagnosis menu as indicated in the table below.

TYPE	Press simultaneously			Whilst pressing
Digital / Exclusive	EXPRESSO LUNGO	EXPRESSO	STEAM	STANDBY
Digital Redesign	EXPRESSO LUNGO	Powder coffee	EXPRESSO	COFFEE

(The user programme is also available in this mode.)

Using the ▲ button scroll to the menu item "Diagnosis" and confirm via the ENTER button.

Changing programme values: Access appropriate item using the ENTER button.
Change value with ARROW buttons
Save value by using the ENTER button.

Programme table (diagnosis menu)

Function/Standard	Setting range	Increment	Comments
EXPRESSO LUNGO No. of PULSES 600	50 – 1,000 Pulses	+/- 1	Number of flow meter pulses for each saved cup fill volume, where 300 pulses correspond to approx. 100 ml.
EXPRESSO No. of PULSES 195	50 – 1,000 Pulses	+/- 1	
COFFEE No. of PULSES 360	50 – 1,000 Pulses	+/- 1	
----HEATING---- PARAMETER K1 7	1 – 50	+/- 1	Do not change!
----HEATING---- PARAMETER K2 30	1 – 50	+/- 1	Do not change!
NORMAL TEMP. ° C 86	70- 130°C	+/- 1	Normal temperature is used if not more than 6 min. have elapsed since last coffee dispensed.
HIGH TEMP. ° C 92	70- 130°C	+/- 1	If no coffee is dispensed for an extended time (over 6 min.), the next coffee will be heated to a higher temperature to compensate for cooling of the brewing unit and the associated temperature loss.
TEMP.OF 1st COFFEE ° C 94	70- 130°C	+/- 1	Used when dispensing the first coffee after the machine has been turned on, to compensate for the high temperature loss due to the cold brewing unit and water pipes.

Function	Setting range	Increment	Comments
TEMP. INCREASE °C 10	0-50°C	+/-1	The boiler temperature is increased by a set value shortly before brewing in order to pre-heat the boiler. and compensate for the temperature drop during the first water flow.
GRINDS COUNTER Number	0-50	+/-1	Counts number of coffee cycles. When this value reaches the Grinds Stop value, "GRINDS CONTAINER EMPTY" will be displayed. (Reset by removing dregs drawer for emptying - min. 6 sec.)
GRINDS STOP 30	5-50	+/-1	Number of cycles until "EMPTY GRINDS CONTAINER" is displayed.
--TOTAL WATER-- (ml) Number	-----	-----	Total water flow volume (in ml) / not resettable
WATER DESCALING (ml)	-----	-----	Total water flow (in ml) since last descaling / resettable
HOT WATER FLOW (l/h) 20	6 - 34 l/h	+/- 2 l/h	The pump delivery rate for hot water can be expressed in litres per hour.
--HOT WATER--- PUMP ADJUST. 63000	58,000 - 65,500	+/- 1	The pump delivery rate is adjusted in relation to the HOT WATER FLOW setting by means of a phase controlled modulator. Pump tolerances can thus also be adjusted. An equivalent value is saved under HOT WATER PUMP ADJUSTMENT.
MACHINE STATUS	0 - 255		36
--DATE OF MANUF--- DAY	-----	-----	This date indicates when the machine was manufactured. This date cannot be changed.
--DATE OF MANUF--- MONTH	-----	-----	
--DATE OF MANUF--- YEAR	-----	-----	
--SERVICE DATE-- DAY	0 - 31	+/- 1	The service date indicates the date of the machine's last service. This date can be changed and must be updated at each service.
--SERVICE DATE-- MONTH	0 - 12	+/- 1	
--SERVICE DATE-- YEAR	1996 - 2050	+/- 1	

Exit: Switch the machine off at the main switch or by pressing ESC twice.

3. Service programme (Royal Professional Instant Steam / Cappuccino / Cappuccino Redesign)

3.1. Test mode

Access (Royal Professional Instant Steam/ Cappuccino):

Access the test mode from the standby mode by keeping the EXPRESSO and HOT WATER button pressed, whilst pressing the STANDBY button again.

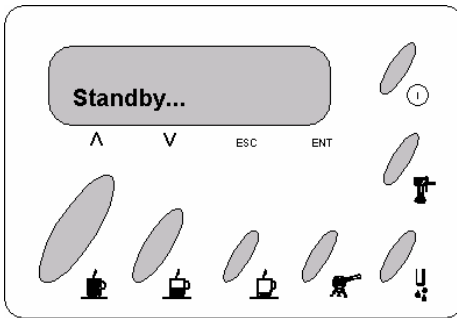

Access (Cappuccino Redesign):

Access the service programme from the standby mode (Menu + Enter) by keeping the coffee, powder coffee and expresso buttons pressed, whilst pressing the Menu button button. **(Important: Press the menu button only briefly to enter the service mode!)**

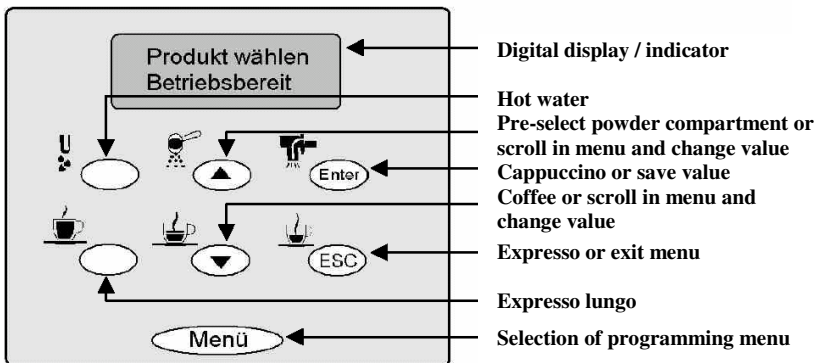

The various functions indicated in the table can be checked by pressing the button combinations listed below.

Programme table (test menu)

Buttons Royal Professional Royal Cappuccino	S1 Espresso lungo	S2 Coffee	S3 Espresso	S4 Powder coffee	S5 Water	S6 Standby	Cappuc- cino
Royal Digital Redes.	S1 Water	S2 Powder coffee	S3 Cappuc- cino	S4 Espresso lungo	S5 Coffee	S6 Espresso	Menu
Unit up	x						
Unit down		x					
Grinder			x				
Heating plate	x				x		
Doser rinse				x			
Heating (System 1)		x			x		
Supplementary heating (System 1)			x		x		
Heating (System 2)				x	x		
Temperature indicator in °C				x	x	x	
Magnet valve Cappuccino maker							x
Pump System 1 (Water)	x					x	
Pump System 2 (steam)	x				x	x	
Magnet valve steam		x				x	
Magnet valve water			x			x	
Pump System 1 + Steam + Water valve				x		x	
Pump System 2 + Magnet steam valve			x		x	x	
Pump System 1 + Magnet water valve			x		x	x	
Magnet valve By-Pass				x		x	
Pump System 2 + Magnet By-Pass valve Magnet valve steam Open steam valve!		x				x	
Pump System 2 + Magnet By-Pass valve Magnet water valve			x			x	

The upper display line signals the activated microswitch and the Hall effect of the turbine.
The activated buttons are signalled by the lower display line (e.g. 1=S1, 2=S2, etc.).

All CPU input signals from the machine appear in the first line of the display.	All CPU input signals from the control board appear in the second line of the display.	
Royal Exclusive / Digital / Digital Redesign	Royal Professional Royal Cappuccino	Royal Capp. Redesign
1 = Brewing unit in brewing position (brewing unit microswitch activated)	1 = Espresso lungo	1 = Water
2 = Brewing unit in idle position (idle position microswitch activated)	2 = Coffee	2 = Powder coffee
3 = Doser chamber full (doser microswitch activated)	3 = Espresso	3 = Cappuccino maker
4 = HWS valve microswitch activated	4 = Powder coffee	4 = Espresso lungo
5 = Grinds container microswitch activated	5 = Steam	5 = Coffee
6 = Brewing unit microswitch activated	6 = Standby	6 = Espresso
7 = Water tank filled (reed contact not activated)	7 = Cappuccino maker	7 = Menu
8 = Flow meter pulse system 1 (Water) (indicator flashes when magnet passes Hall generator)		
9 = Flow meter pulse system 2 (steam) (indicator flashes when magnet passes Hall generator)		

Flow rate:

If the pump is activated during test mode and the hot water valve opened, a two-digit number appears at the bottom right side indicating the flow rate. This value must be between 40 - 60.

Grinder rate:

If no button is activated, a number appears at the bottom right side referring to the grinder rate. This value must be between 125 - 135.

Exit: Switch the machine off at the main switch.

3.2. Diagnosis menu (Royal Professional Instant Steam / Cappuccino / Cappuccino Redesign)

The values below can be read and adjusted in the diagnosis menu as shown in the table.

Access: The following button combinations can be used in standby mode to access the diagnosis menu as indicated in the table below. (press menu buttons briefly)

TYPE	Press simultaneously			Whilst pressing
Prof. / Cappuccino	EXPRESSO LUNGO	EXPRESSO	HOT WATER	STANDBY
Cappuccino Redes.	EXPRESSO LUNGO	Powder coffee	EXPRESSO	MENU

(The user programme is also available in this mode.)

Using the ▲ button scroll to the menu item "Diagnosis" and confirm via the ENTER button.

Changing programme values: Access appropriate item using the ENTER button.
Change value with ARROW buttons
Save value by using the ENTER button.

Programme table (diagnosis menu):

Function/Standard	Setting range	Increment	Comments
EXPRESSO LUNGO No. of PULSES 600	50 – 1,000 Pulses	+/- 1	Number of flow meter pulses for each saved cup fill volume, where 300 pulses correspond to approx. 100 ml.
EXPRESSO No. of PULSES 195	50 – 1,000 Pulses	+/- 1	
COFFEE No. of PULSES 360	50 – 1,000 Pulses	+/- 1	
HOT WATER No. of PULSES 360	50 – 1,000 Pulses	+/- 1	
CAPPUCCINO TIME SEC. 7	240	+/- 1	The time for cappuccino dispensing is saved under this item (cup filling volume).
---HEATING--- PARAMETER K1 7	1 – 50	+/- 1	Do not change!
---HEATING--- PARAMETER K2 30 New processor 40 From 2003 version	1 – 50	+/- 1	Do not change!
---HEATING--- SENSOR ADJUST. 96 From 2003 version	86 – 106		To adjust processor tolerances. If the temperature in test mode with a set measuring resistance of 3246Ω exceeds or falls short of the specified temperature value (96°C) by more than 1°C, the value indicated in test mode must be applied to adjust the sensor. No measuring resistance: Do not change!

Function	Setting range	Increment	Comments
NORMAL TEMP. °C 86/90	70- 130°C	+/- 1	Normal temperature is used if not more than 6 min. have elapsed since last coffee dispensed.
HIGH TEMP. °C 92/98	70- 130°C	+/- 1	If no coffee is dispensed for an extended time (over 6 min.), the next coffee will be heated to a higher temperature to compensate for cooling of the brewing unit and the associated temperature loss.
TEMP. OF 1st COFFEE ° C 94/100	70- 130°C	+/- 1	Used when dispensing the first coffee after the machine has been turned on, to compensate for the high temperature loss due to the cold brewing unit and water pipes.
STEAM TEMP. °C 130/110	70- 135°C	+/-1	Steam temperature 110°C only in Redesign machines under the item: STEAM TEMP. INC. (steam temperature increase)
COFFEE TEMP. INCREASE °C 10/7	0-50°C	+/-1	The boiler temperature is increased by a set value shortly before brewing in order to pre-heat the boiler. and compensate for the temperature drop during the first water flow.
STEAM TEMP. INCR. °C 15	0-50°C	+/-1	In Redesign models the constant temperature of 110°C is increased by 15°C during steam dispensing.
STEAM 35	20-50	+/-1	Pulsing of pump during steam dispensing.
CAPPUCCINO 30	20-50	+/-1	Pulsing of pump during cappuccino dispensing.
GRINDS COUNTER Number	0-50	+/-1	Counts number of coffee cycles. When this value reaches the Grinds Stop value, "GRINDS CONTAINER EMPTY" will be displayed. (Reset by removing dregs drawer for emptying - min. 6 sec.)
GRINDS STOP 30	5-50	+/-1	Number of cycles until "EMPTY GRINDS CONTAINER" is displayed.
TOTAL WATER....S1 (ml) Number			Pump system 1 Total water flow volume (in ml) / not resettable
WATER DESCALING S1 (ml)			Pump system 1: Total water flow (in ml) since last descaling. Reset: Press cappuccino button for 5 sec. Redesign - Espresso lungo +ESC

Function	Setting range	Increment	Comments
TOTAL WATER...S2 (ml) Number			Pump system 2 Total water flow volume (in ml) / not resettable
WATER DESCALING S2 (ml)			Pump system 2: Total water flow (in ml) since last descaling. Reset: See S1
HOT WATER FLOW (l/h) 20 (Only in System 2: OFF for Royal Cappucc.)	6 – 34 l/h	+/- 2 l/h	The pump delivery rate for hot water can be expressed in litres per hour.
HOT WATER PUMP ADJUST. 63000 (Only in System 2: OFF for Royal Cappucc.)	58,000 - 65,500	+/- 1	The pump delivery rate is adjusted in relation to the HOT WATER FLOW setting by means of a phase controlled modulator. Pump tolerances can thus also be adjusted. An equivalent value is saved under HOT WATER PUMP ADJUSTMENT.
TURBOWATER FLOW (l/h) 20 (Only in System 2: ON) only Royal Cappucc.)	6 - 34 l/h	+/- 2 l/h	The pump delivery rate for turbowater can be expressed in litres per hour. (only active when System 2 steam cycle is active; mixes with hot water System 1 and System 2)
TURBOWATER PUMP ADJUST. 63000 (Only in System 2: ON) (only Royal Cappucc.)	58,000 - 65,500	+/- 1	The pump delivery rate is adjusted in relation to the TURBOWATER FLOW setting by means of a phase controlled modulator. Pump tolerances can thus also be adjusted. An equivalent value is saved under TURBOWATER PUMP ADJUSTMENT. Only when System 2 is activated.
WATER RESERVE NUMBER No. of PULSES NUMBER From Version: 2003	1-2500		When the water tank is full, the value from WATER RESERVE STOP is applied. The flow meter pulses are counted from when the reed switch is switched and deducted from the value. If a beverage is chosen for which the saved pulse number is higher than the remaining pulses, the message FILL WATER TANK appears.

Function	Setting range	Increment	Comments
WATER RESERVE STOP No. of PULSES 1000 From Version: 2003	1-2500		Water reserve from when the read switch is switched to pulses.
MACHINE STATUS	0 - 255		100
--DATE OF MANUF--- DAY	-----	----- --	This date indicates when the machine was manufactured. This date cannot be changed.
--DATE OF MANUF--- MONTH	-----	----- --	
--DATE OF MANUF--- YEAR	-----	----- --	
--SERVICE DATE-- DAY	0 - 31	+/- 1	The service date indicates the date of the machine's last service. This date can be changed and must be updated at each service.
--SERVICE DATE-- MONTH	0 - 12	+/- 1	
--SERVICE DATE-- YEAR	1996 - 2050	+/- 1	

Exit: Switch the machine off at the main switch.

4. Service programme (Royal Professional Rapid Steam / Coffeebar / Profess. Redesign / Digital Plus)

4.1. Test mode

Access (Royal Professional Rapid Steam / Coffeebar):

Access the test mode by turning on the machine and simultaneously pressing the coffee and steam buttons.

Keep the EXPRESSO and HOT WATER buttons pressed, whilst pressing the STANDBY button.

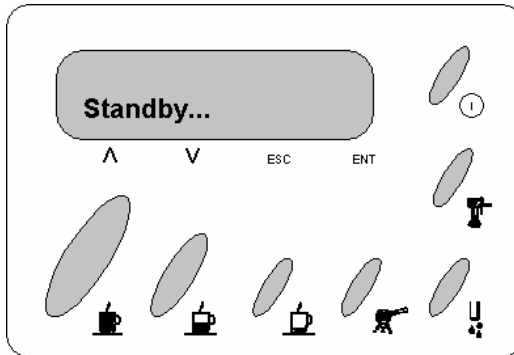

Access (Professional Redesign):

Access the service programme from the standby mode (Menu + Enter) by keeping the coffee, powder coffee and expresso buttons pressed, whilst pressing the Menu button. (**Attention:** press menu button briefly)

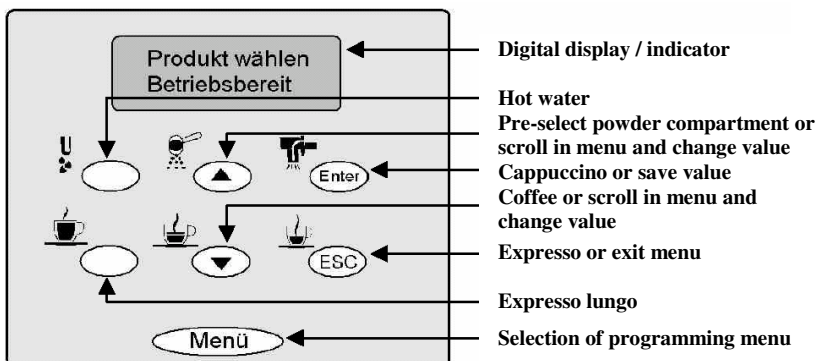

Access (Digital Plus):

Access the service programme from the standby mode (standby button) by keeping the powder coffee , espresso and coffee buttons pressed.

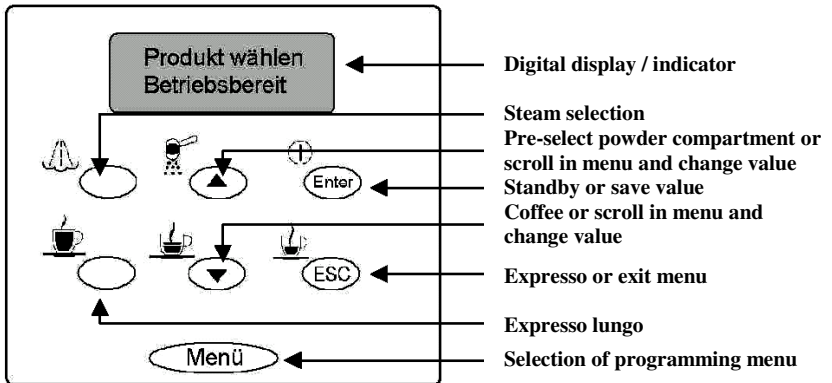

The various functions indicated in the table can be checked by pressing the button combinations listed below.

Programme table (test menu)

Buttons	S1	S2	S3	S4	S5	S6	S7
Profess. Rapid Steam Royal Coffeebar	Espresso lungo	Coffee	Espresso	Powder coffee	Water	Standby	Cappuc- cino
Royal Profes. Redes. Buttons	S1 Water	S2 Powder coffee	S3 Cappuc- cino	S4 Espresso lungo	S5 Coffee	S6 Espresso	S7 Menu
Royal Digital Plus button	S1 Water	S2 Powder coffee	S3 Standby	S4 Espresso lungo	S5 Coffee	S6 Espresso	S7 Menu
Unit up	x						
Unit down		x					
Grinder			x				
Heating plate	x				x		
Doser rinse				x			
Heating (System 1)		x			x		
Supplementary heating (System 1)			x		x		
Heating (System 2)				x	x		
Temperature indicator in °C				x	x	x	

Buttons	S1	S2	S3	S4	S5	S6	S7
Magnet valve Cappuccino maker Not for Digit. Plus							x
Pump	x					x	
Magnet valve steam		x			x	x	
Magnet valve water	x				x	x	
Pump + Magnet water valve		x				x	
Pump + Magnet steam valve			x			x	
Pump + Magnet steam valve Magnet water valve				x		x	

The upper display line signals the activated microswitch and the Hall effect of the turbine.

The activated buttons are signalled by the lower display line (e.g. 1=S1, 2=S2, etc.).

All CPU input signals from the machine appear in the first line of the display.	All CPU input signals from the control board appear in the second line of the display.	
Royal Exclusive / Digital / Digital Redesign	Profess. Rapid Steam Royal Coffeebar	Royal Profes. Redes. Royal Digital Plus
1 = Brewing unit in brewing position (brewing unit microswitch activated)	1 = Espresso lungo	1 = Water
2 = Brewing unit in idle position (idle position microswitch activated)	2 = Coffee	2 = Powder coffee
3 = Doser chamber full (doser microswitch activated)	3 = Espresso	3 = Cappuccino maker Standby (Digit. Plus)
4 = HWS valve microswitch activated	4 = Powder coffee	4 = Espresso lungo
5 = Grinds container microswitch activated	5 = Steam	5 = Coffee
6 = Brewing unit microswitch activated	6 = Standby	6 = Espresso
7 = Water tank filled (reed contact not activated)	7 = Cappuccino maker	7 = Menu
8 = Flow meter pulse system 1 (Water) (indicator flashes when magnet passes Hall generator)		

Flow rate:

If the pump is activated during test mode and the hot water valve opened, a two-digit number appears at the bottom right side indicating the flow rate. This value must be between 40 - 60.

Grinder rate:

If no button is activated, a number appears at the bottom right side referring to the grinder rate. This value must be between 125 - 135.

Exit: Switch the machine off at the main switch.

4.2. Diagnosis menu (Royal Professional Rapid Steam / Coffeebar / Profess. Redesign / Digital Plus)

The values below can be read and adjusted in the diagnosis menu as shown in the table.

Access: The following button combinations can be used in standby mode to access the diagnosis menu as indicated in the table below (press menu buttons briefly).

TYPE	Press simultaneously			Whilst pressing
Prof. / Coffeebar	EXPRESSO LUNGO	EXPRESSO	HOT WATER	STANDBY
Prof. Redes./ Dig. +	EXPRESSO LUNGO	Powder coffee	EXPRESSO	MENU

(The user programme is also available in this mode.)

Using the ▲ button scroll to the menu item "Diagnosis" and confirm via the ENTER button.

Changing programme values: Access appropriate item using the ENTER button.
Change value with ARROW buttons
Save value by using the ENTER button.

Programme table (diagnosis menu):

Function/Standard	Setting range	Increment	Comments
EXPRESSO LUNGO No. of PULSES 600	50 – 1,000 Pulses	+/- 1	Number of flow meter pulses for each saved cup fill volume, where 300 pulses correspond to approx. 100 ml.
EXPRESSO No. of PULSES 195	50 – 1,000 Pulses	+/- 1	
COFFEE No. of PULSES 360	50 – 1,000 Pulses	+/- 1	
HOT WATER No. of PULSES 360	50 – 1,000 Pulses	+/- 1	
CAPPUCCINO TIME SEC. 7	240	+/- 1	The time for cappuccino dispensing is saved under this item (cup filling volume).
---HEATING--- PARAMETER K1 7	1 – 50	+/- 1	Do not change!
---HEATING--- PARAMETER K2 30 New processor 40 From 2003 version	1 – 50	+/- 1	Do not change!
---HEATING--- SENSOR ADJUST. 96 From 2003 version	86 – 106		To adjust processor tolerances. If the temperature in test mode with a set measuring resistance of 3246Ω exceeds or falls short of the specified temperature value (96°C) by more than 1°C, the value indicated in test mode must be applied to adjust the sensor. No measuring resistance: Do not change!

Function	Setting range	Increment	Comments
NORMAL TEMP. °C 86/90	70- 130°C	+/- 1	Normal temperature is used if not more than 6 min. have elapsed since last coffee dispensed.
HIGH TEMP. °C 92/98	70- 130°C	+/- 1	If no coffee is dispensed for an extended time (over 6 min.), the next coffee will be heated to a higher temperature to compensate for cooling of the brewing unit and the associated temperature loss.
TEMP. OF 1st COFFEE ° C 94/100	70- 130°C	+/- 1	Used when dispensing the first coffee after the machine has been turned on, to compensate for the high temperature loss due to the cold brewing unit and water pipes.
STEAM TEMP. °C 130/110	70- 135°C	+/-1	Steam temperature 110°C only in Redesign machines under the item: STEAM TEMP. INC. (steam temperature increase)
COFFEE TEMP. INCR. °C 10/7	0-50°C	+/-1	The boiler temperature is increased by a set value shortly before brewing in order to pre-heat the boiler. and compensate for the temperature drop during the first water flow.
STEAM TEMP. INCR. °C 15	0-50°C	+/-1	In Redesign models the constant temperature of 110°C is increased by 15°C during steam dispensing.
STEAM 35	20-50	+/-1	Pulsing of pump during steam dispensing.
CAPPUCCINO 30	20-50	+/-1	Pulsing of pump during cappuccino dispensing.
GRINDS COUNTER Number	0-50	+/-1	Counts number of coffee cycles. When this value reaches the Grinds Stop value, "GRINDS CONTAINER EMPTY" will be displayed. (Reset by removing dregs drawer for emptying - min. 6 sec.)
GRINDS STOP 30	5-50	+/-1	Number of cycles until "EMPTY GRINDS CONTAINER" is displayed.
TOTAL WATER....S1 (ml) Number			Pump system 1 Total water flow volume (in ml) / not resettable
WATER DESCALING S1 (ml)			Pump system 1: Total water flow (in ml) since last descaling. Reset: Press cappuccino button for 5 sec. Redesign: Espresso lungo +ESC

Function	Setting range	Increment	Comments
TOTAL WATER...S2 (ml) Number			Pump system 2 Total water flow volume (in ml) / not resettable
WATER DESCALING S2 (ml)			Pump system 2: Total water flow (in ml) since last descaling. Reset: See S1
HOT WATER FLOW (l/h) 20	6 – 34 l/h	+/- 2 l/h	The pump delivery rate for hot water can be expressed in litres per hour.
HEISSWASSER--- PUMPENREG 63000	58,000 - 65,500	+/- 1	The pump delivery rate is adjusted in relation to the HOT WATER FLOW setting by means of a phase controlled modulator. Pump tolerances can thus also be adjusted. An equivalent value is saved under HOT WATER PUMP ADJUSTMENT.
WATER RESERVE NUMBER No. of PULSES 1000 From Version: 2003	1-2500		Counts the pulses programmed under water reserve stop from when the reed switch switches. The indicator signalling the need to fill the water tank then appears.
WATER RES. STOP No. of PULSES NUMBER From Version: 2003	1-2500		Number of residual pulses from when the reed switch switches to when the water low indicator appears. (can be changed)
TURBO FACTOR	10 - 250		Conversion factor for pressure- resistant flow meter. (Setting value for Roy. Profess.: 100 (Setting value for Roy. Coffeebar: 77
MACHINE STATUS 100	0 - 255		Operating status
--DATE OF MANUF--- DAY	-----	-----	This date indicates when the machine was manufactured. This date cannot be changed.
--DATE OF MANUF--- MONTH	-----	-----	
--DATE OF MANUF--- YEAR	-----	-----	
--SERVICE DATE-- DAY	0 - 31	+/- 1	The service date indicates the date of the machine's last service. This date can be changed and must be updated at each service.
--SERVICE DATE-- MONTH	0 - 12	+/- 1	
--SERVICE DATE-- YEAR	1996 - 2050	+/- 1	

Exit: Switch the machine off at the main switch.

5. Service programme (Royal Office)

5.1. Test mode

Access (Royal Office):

Keep the water and espresso buttons pressed and turn machine on. While the buttons are pressed, the E-Prom Version is displayed (e.g. Version 0.13).

The various functions indicated in the table can be checked by pressing the button combinations listed below.

Programme table (test menu)

Buttons	S1 Espresso	S2 Coffee	S3 Hot water	S4 cup warmer
Unit up	x			M1
Unit down		x		M1
Heating 1-1090 W			x	M1
Grinder	x			M2
Doser				M2
Heating 2 – 437W		x		M2
Pump			x	M3
Hot water magnet valve				M3
Coin validator price 1				M4
Coin validator price 2				M4
Reset coin validator				M4
Temperature				M5

The upper display line signals the activated microswitch and the Hall effect of the flow meter. The activated buttons are signalled by the lower display line (e.g. 1=S1, 2=S2, etc.).

All CPU input signals from the machine appear in the first line of the display.

- 1 = Brewing unit in brewing position
(brewing unit microswitch activated)
- 2 = Brewing unit in idle position
(idle position microswitch activated)
- 3 = Doser microswitch activated (full)
- 4 = HWS valve microswitch activated
- 5 = Grinds container microswitch activated
- 6 = Brewing unit microswitch activated
- 7 = Water tank full (reed contact not activated)
- 8 = Flow meter pulses (indicator appears as soon as the magnet passes the sensor)

All CPU input signals from the control board appear in the second line of the display.

1 = Coffee
2 = Espresso
3 = Hot water

Flow rate

If the pump is activated during test mode and the hot water valve opened, a two-digit number appears at the bottom right side indicating the flow rate. This value must be between 40 - 60.

Grinder rate

If no button is activated, a number appears at the bottom right side referring to the grinder rate. This value must be between 125 - 135.

Exit: Switch the machine off at the main switch.

5.2. Diagnosis menu (Royal Office)

The values below can be read and adjusted in the diagnosis menu as shown in the table.

Access: Access the user menu (Keep the C + hot water button pressed and turn machine on from main switch).

Enter code: 111111 = Press the expresso button six times.

Using the ▲ button scroll to the menu item "Diagnosis" and confirm with the E = Espresso button.

Changing programme values: Access appropriate item using the E-button.
Change value with ARROW buttons
Save value by using the E-button.

Programme table (diagnosis menu)

Function/Standard	Setting range	Increment	Comments
EXPRESSO No. of PULSES 195	50 - 800 Pulses	+/- 1	Number of flow meter pulses for each saved cup fill volume, where 300 pulses correspond to approx. 100 ml.
COFFEE No. of PULSES 360	50 - 800 Pulses	+/- 1	
HOT WATER No. of PULSES 360	50 - 800 Pulses	+/- 1	Saved pulse number for hot water quantity programme
----HEATING---- PARAMETER K1 7	1 – 50	+/- 1	Do not change!
----HEATING---- PARAMETER K2 40	1 – 50	+/- 1	Do not change!
NORMAL TEMP. °C 86	70- 130°C	+/- 1	Normal temperature is used if not more than 6 min. have elapsed since last coffee dispensed.
HIGH TEMP. °C 92	70- 130°C	+/- 1	If no coffee is dispensed for an extended time (over 6 min.), the next coffee will be heated to a higher temperature to compensate for cooling of the brewing unit and the associated temperature loss.
TEMP. OF 1st COFFEE °C 94	70- 130°C	+/- 1	Used when dispensing the first coffee after the machine has been turned on, to compensate for the high temperature loss due to the cold brewing unit and water pipes.
TEMP. INCREASE °C 10	0-50°C	+/-1	The boiler temperature is increased by a set value shortly before brewing in order to pre-heat the boiler. and compensate for the temperature drop during the first water flow.

Function	Setting range	Increment	Comments
GRINDS COUNTER Number	0-50	+/-1	Counts number of coffee cycles. When this value reaches the Grinds Stop value, "GRINDS CONTAINER EMPTY" will be displayed. (Reset by removing dregs drawer for emptying - min. 6 sec.)
GRINDS STOP 30	5-50	+/-1	Number of cycles until "EMPTY GRINDS CONTAINER" is displayed.
--TOTAL WATER-- (ml) Number	-----	-----	Total water flow volume (in ml) / not resettable
WATER DESCALING (ml) Number	-----	-----	Total water flow (in ml) since last descaling / resettable
HOT WATER FLOW (l/h) 20	6 - 34 l/h	+/- 2 l/h	The pump delivery rate for hot water can be expressed in litres per hour.
--HOT WATER--- PUMP ADJUST. 63000	58,000 - 65,500	+/- 1	The pump delivery rate is adjusted in relation to the HOT WATER FLOW setting by means of a phase controlled modulator. Pump tolerances can thus also be adjusted. An equivalent value is saved under HOT WATER PUMP ADJUSTMENT.
TURBO FACTOR 100	10 - 250		Flow meter conversion factor
MACHINE STATUS 160	0 - 255		
--DATE OF MANUF--- DAY	-----	-----	This date indicates when the machine was manufactured. This date cannot be changed.
--DATE OF MANUF--- MONTH	-----	-----	
--DATE OF MANUF--- YEAR	-----	-----	
	-----	-----	

Exit: Switch the machine off at the main switch.

CHAPTER 6

FAULTS

	Page
1. Faults	1

1. Faults:

The following table indicates the most common faults, listed by component.

Part	Fault	Cause
Electronics	Does not function No display	SI on mains filter defective
		Main switch defective
		Door switch defective
		Electronic system defective
Heating	Cold coffee Standby LED lights up continuously	KTY defective
		Electronic system defective
	Temperature differences No froth	KTY defective
		Electronic system defective
	Heating remains cold Heating indicator remains lit up	Heating - Interruption
		Heating plug connection
Thermal fuse Fusible cut-out		
Doser	Water instead of coffee	(No grinder function) Doser switch constantly activated / Dirt
		Defective doser rinse
	Weak coffee	Dose quantity too low
		Dose chamber - coffee residues
	Recurring indicator COFFEE BEANS LOW - Brewing unit overfull - Gearmotor obstructed	Doser switch does not work
Doser flap does not close Electronic system defective		

Part	Fault	Cause
Grinder	Coffee too strong / flows too slowly	Grinding set too finely
	Coffee too weak / flows too fast, no froth	Grind set too coarsely
		Grinder motor not properly installed
	Grinder functions until the COFFEE BEANS LOW indicator appears on the display (insufficient beans in bean container)	Grinding disc worn
		Water in grinder
	Grinder does not work	Grinding set too finely
Motor defective		
Electronic system defective		
Gearmotor	Brewing unit malfunctions - does not move to home position	Doser switch constantly activated
		MS defective
		Motor defective
		Cup warmer defective
		Fusible cut-out
		Cup warmer defective
		Gear wheel defective
Electronic system defective		
Brewing unit	Sluggish / obstructed	Plunger stiff
		Piston O-ring swollen
		Gasket of valve plug swollen (black O-ring)
		Grinding too coarse
		Over-dosage
HWS system	Water drips from steam pipe (with closed valve)	Securing tab on tea nozzle spout broken / bent
		Valve gasket calcified
	Water drips from steam pipe shaft	Fracture in steam pipe
	Water leakage from HWS spout	Defective O-ring
	Water leakage at joint	Defective O-ring
Hairline crack in HWS valve threaded joint		

Part	Fault	Cause
Overpressure valve	Varying cup filling volume	Overpressure valve does not seal / calcified
	More water in drip tray	
Pump	No suction when pump is in operation	Runs dry / Not de-aerated before initial heating. Inject water jet while pump is in operation.
	Dry coffee in dregs drawer / water low indicator (fault LED)	Defective pump Thermal fuse defective
	Water leakage at overpressure valve threaded joint	Hairline crack in joint area
Flow meter	Different cup filling volumes - Water low indicator flashes	Turbine calcified / other deposits
		Hall sensor defective
Float	WATER LOW INDICATOR indicator (water level over reserve)	Float not watertight
		Float jammed
		Magnet in float too weak
		Electronic system defective
		Reed sensor defective

CHAPTER 7

FAULT DIAGNOSIS

	Page
1. Fault detection (Royal Classic)	1
1.1. Does not function	1
1.2. Machine does not function (red LED flashes)	2
1.3. Machine does not function (red LED lights up)	3
1.4. Water low	5
1.5. Brewing unit / Gearmotor obstructed	6
2. Fault detection (R. Dig./Excl./Prof./Coffeeb.)	7
2.1. Does not function	7
2.2. Machine does not function (grinds container not detected)	8
2.3. Water low	9
2.4. De-aerate	10
2.5. Coffee beans low	11
2.6. Brewing unit / Gearmotor obstructed	12

1. Fault diagnosis (Royal Classic)

1.1 Machine does not function

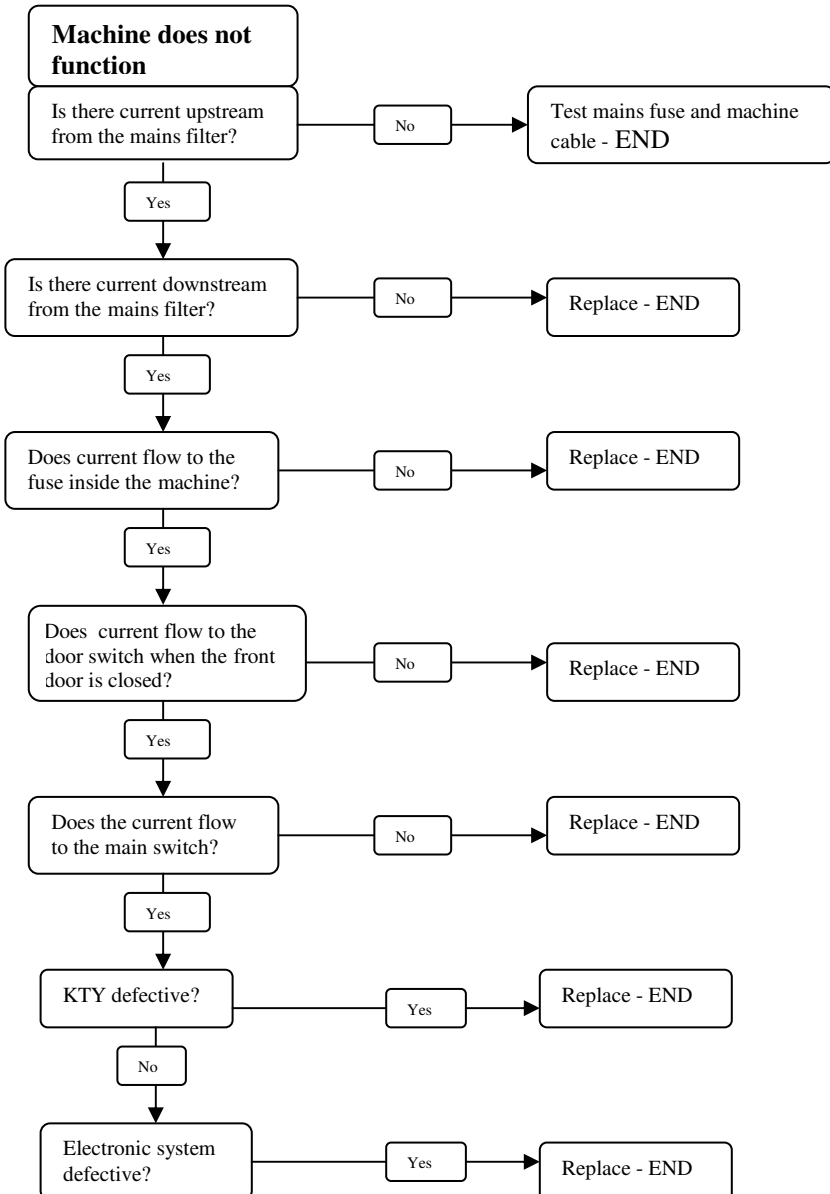

1.2. Machine does not function (red LED flashes)

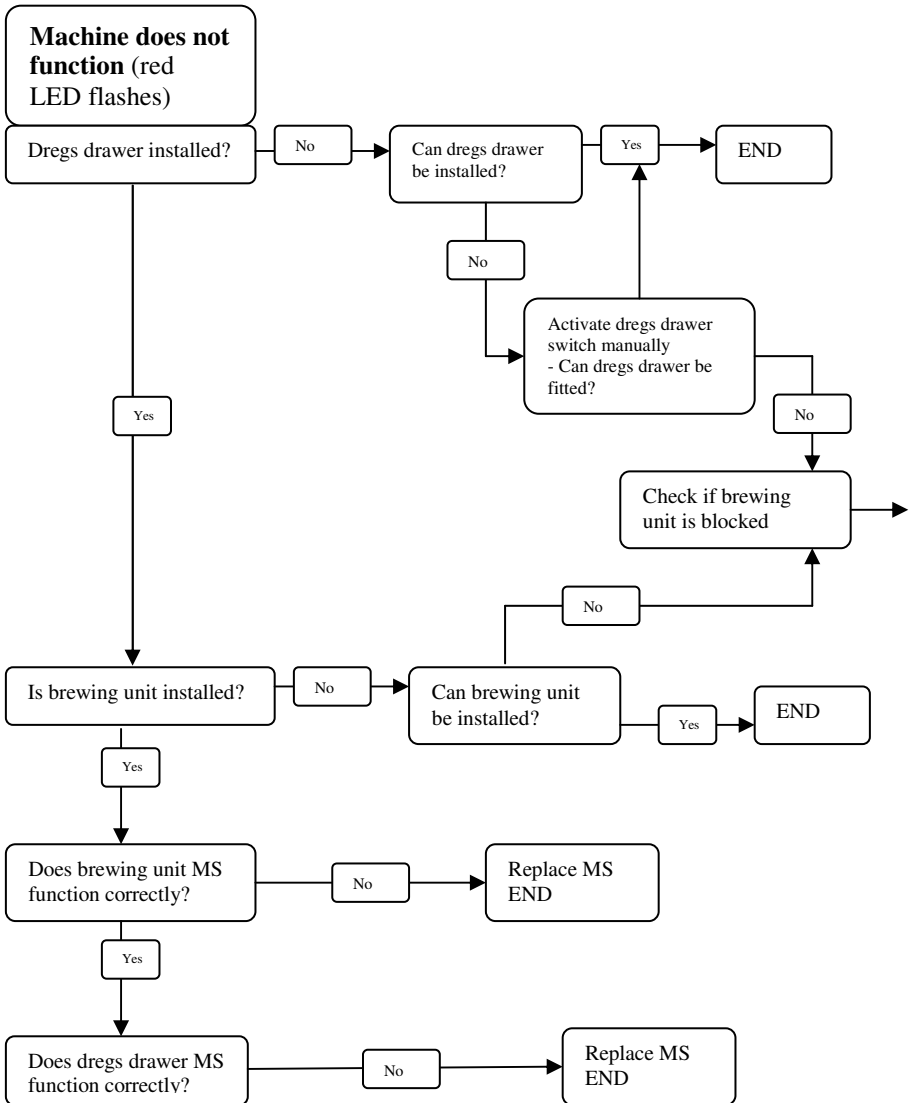

1.3. Machine does not function (red LED lights up)

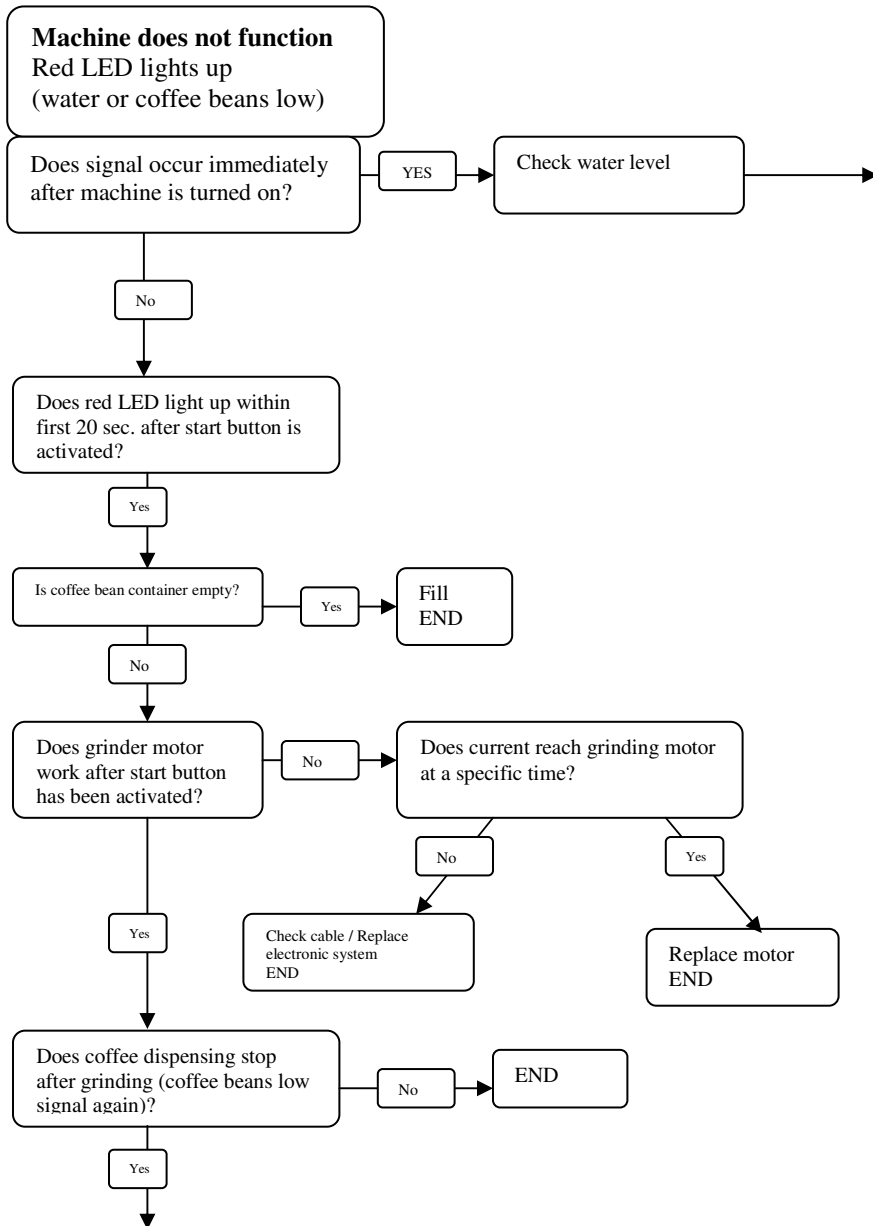

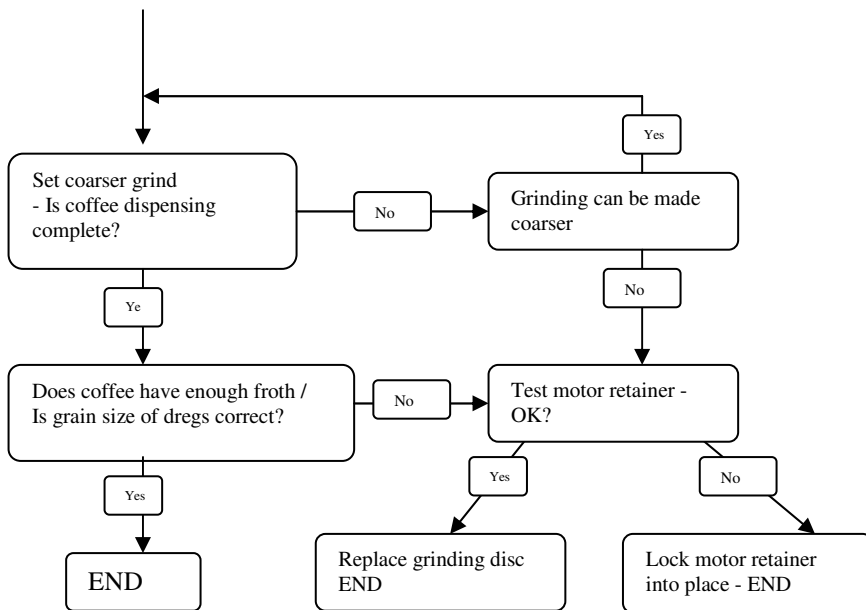

1.4. Water low (red LED lights up)

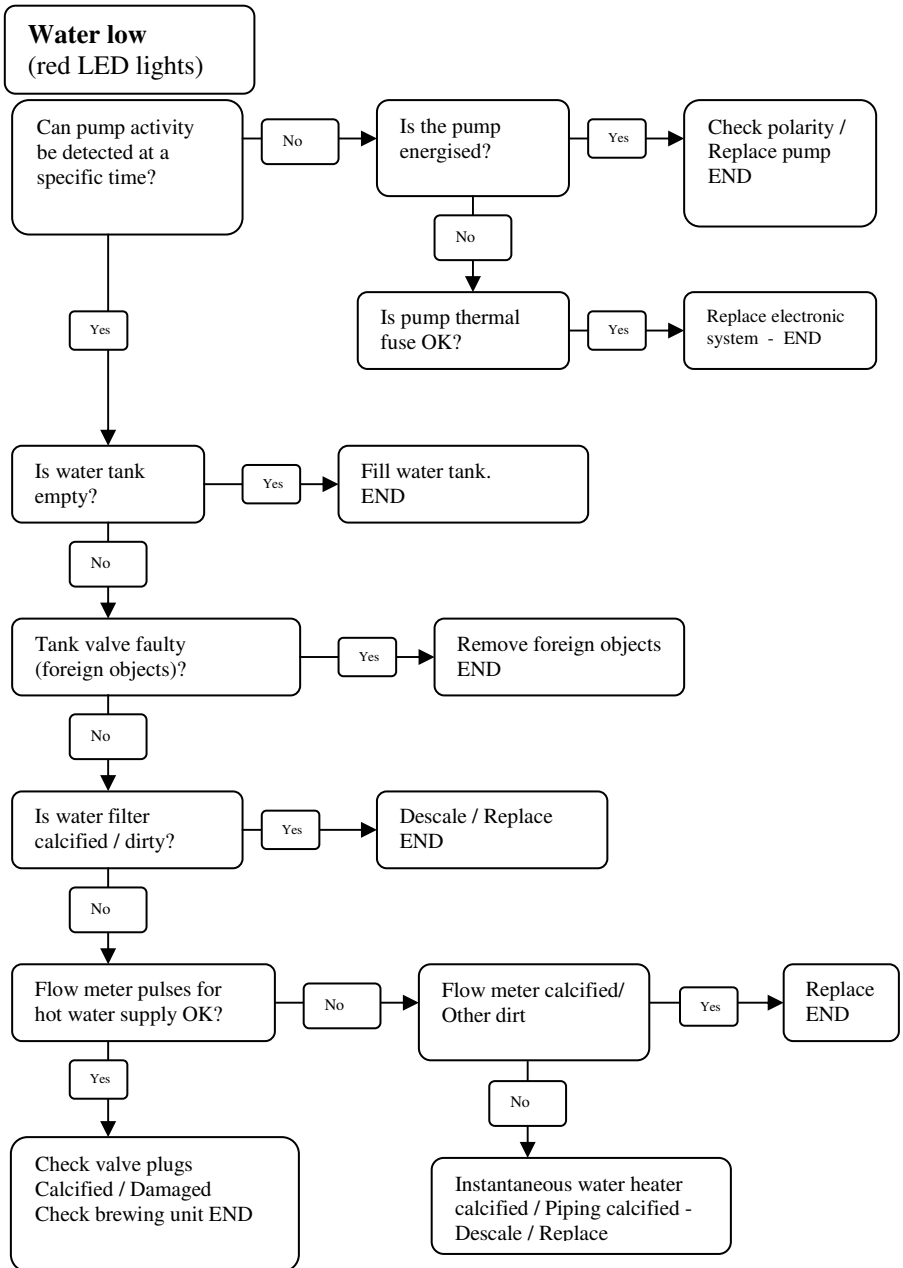

1.5. Brewing unit blocked / Gears blocked

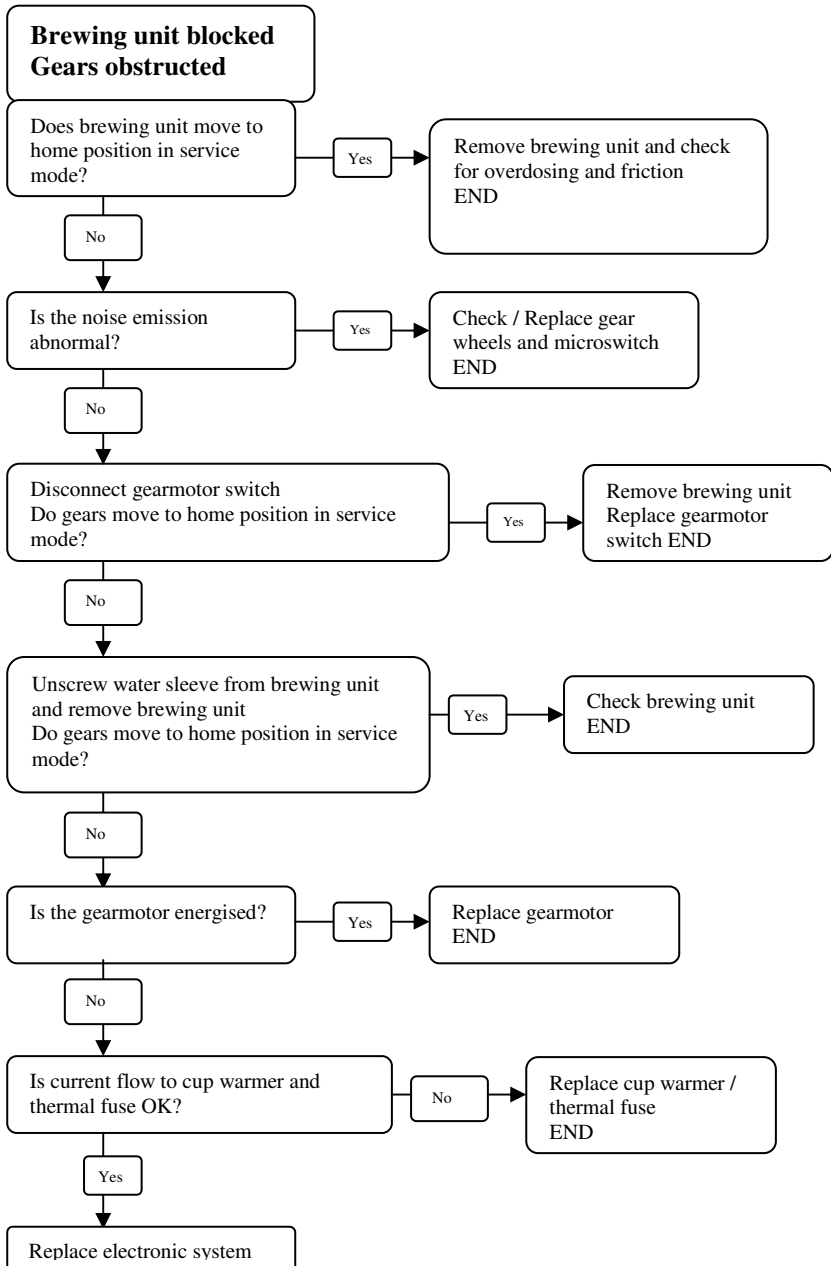

2. Fault diagnosis (Magic de luxe, Comfort and Comfort+)

2.1. Machine does not function

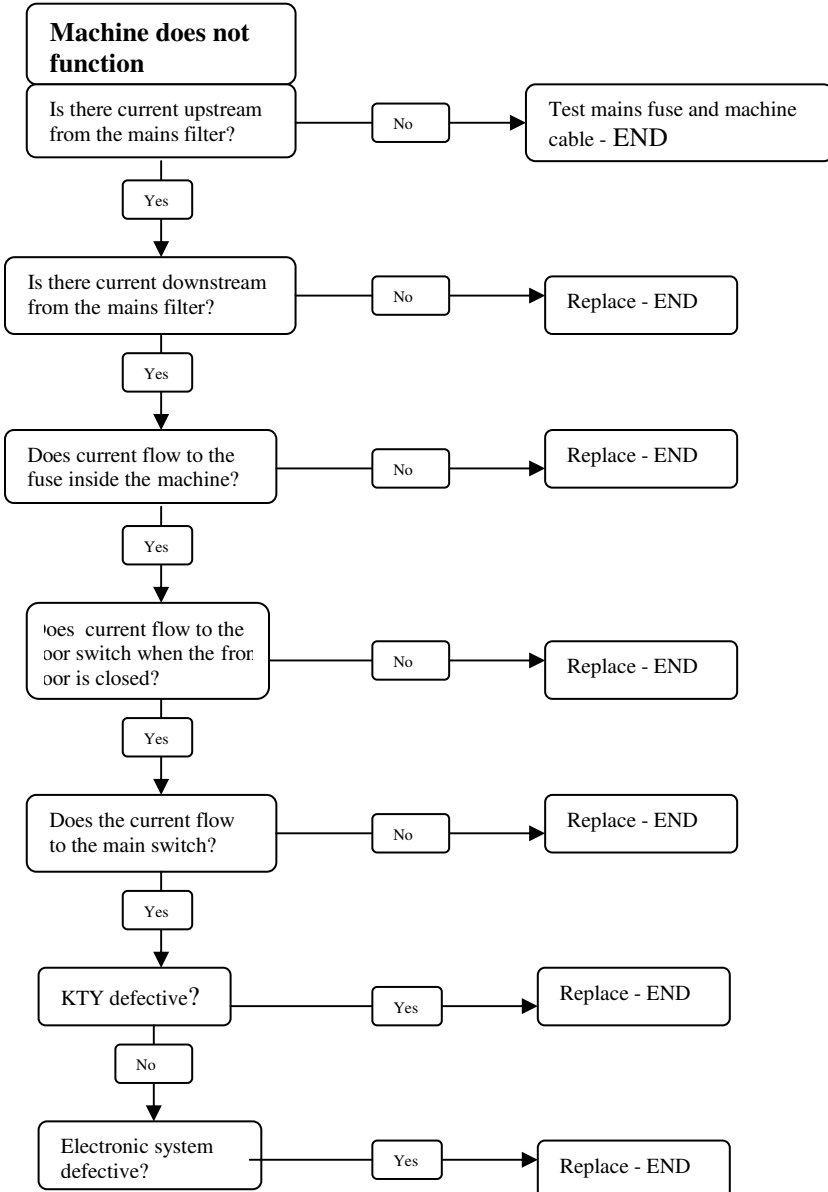

2.2. Machine does not function (Indicator: grinds container not detected)

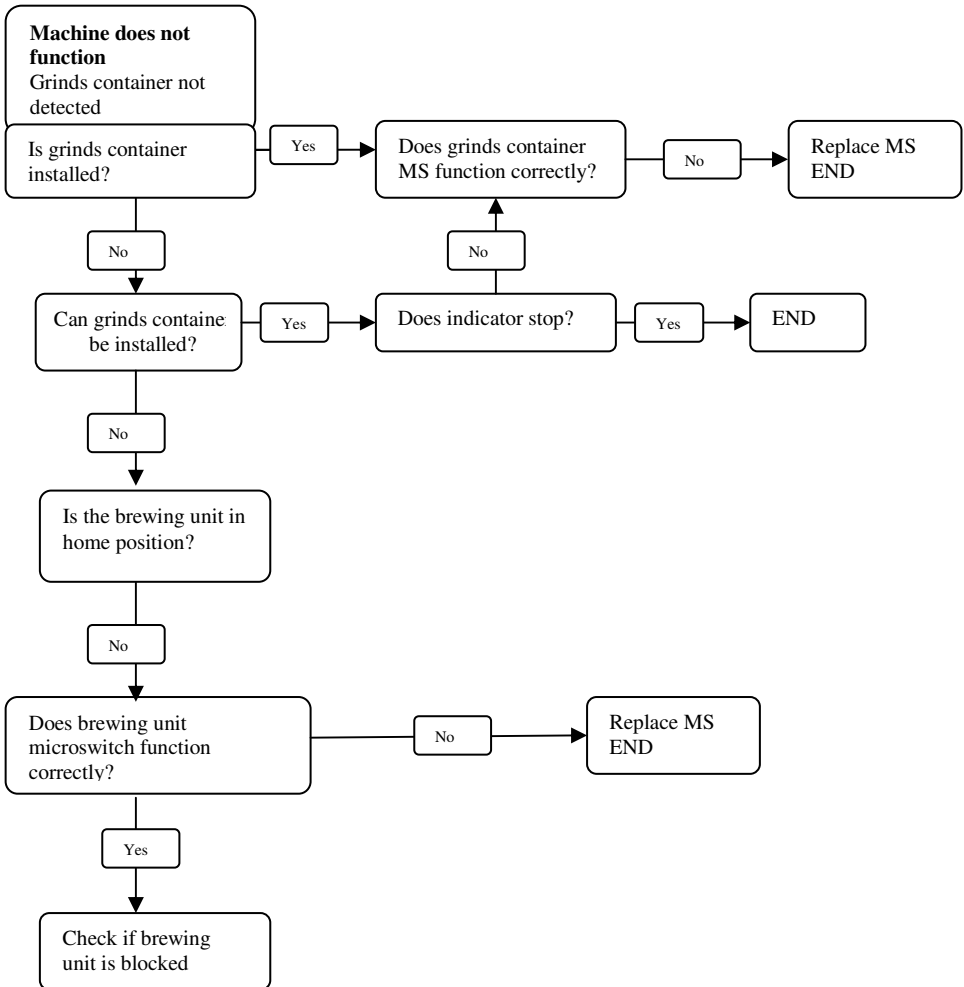

2.3. Water low

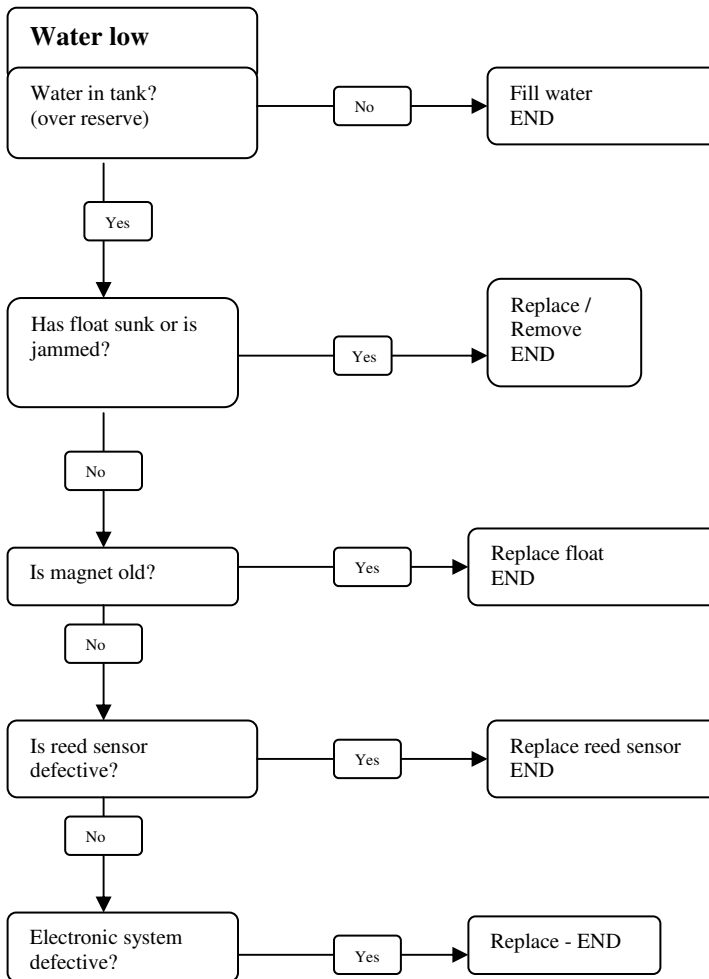

2.4. De-aerate

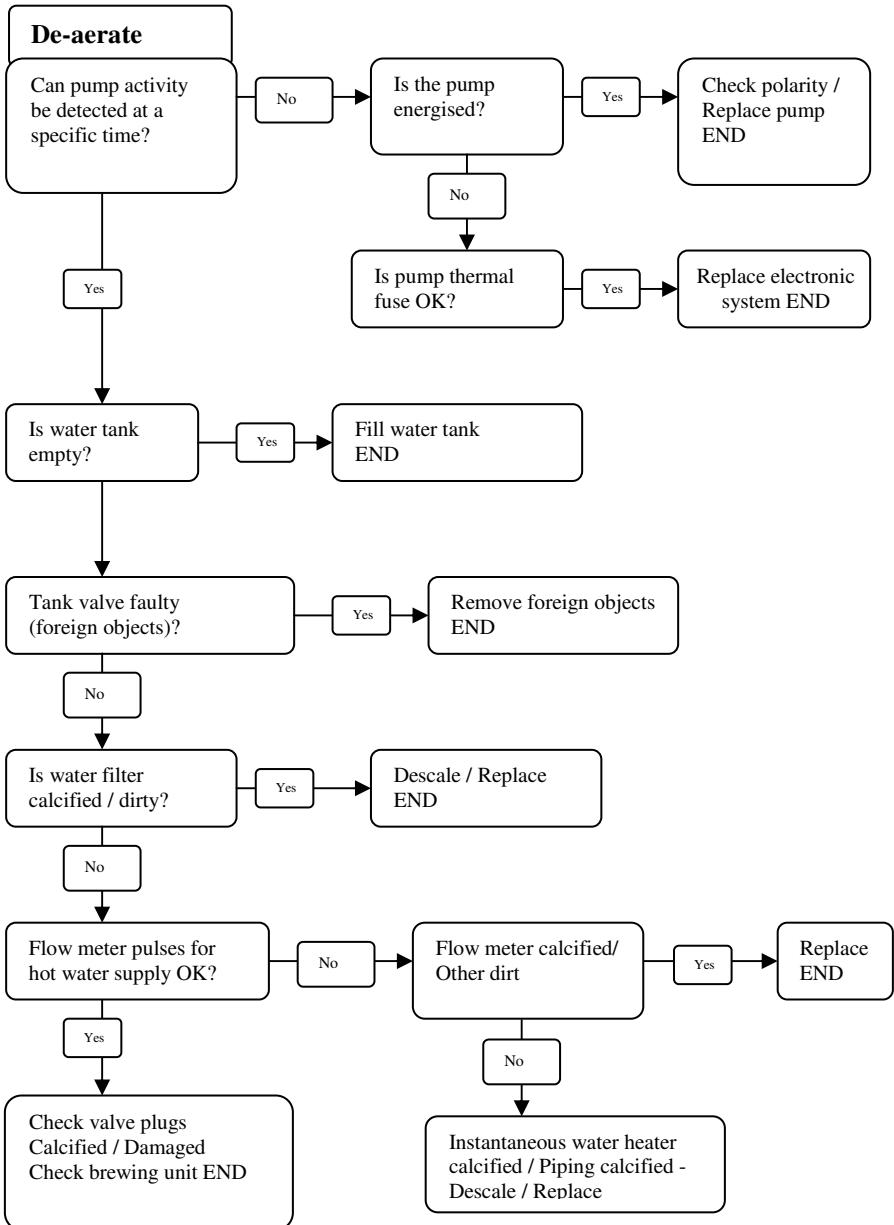

2.5 Coffee Beans Low indicator

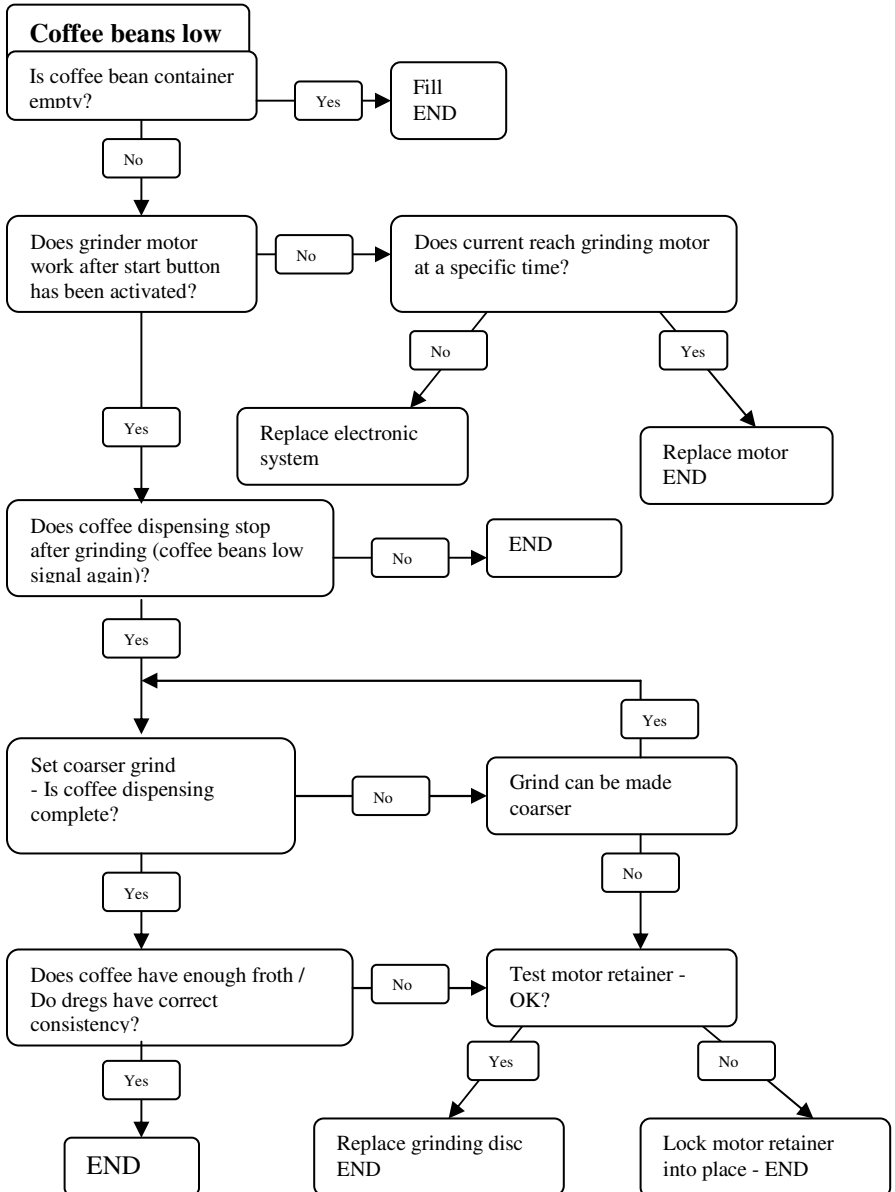

2.6. Brewing unit blocked / Gears blocked

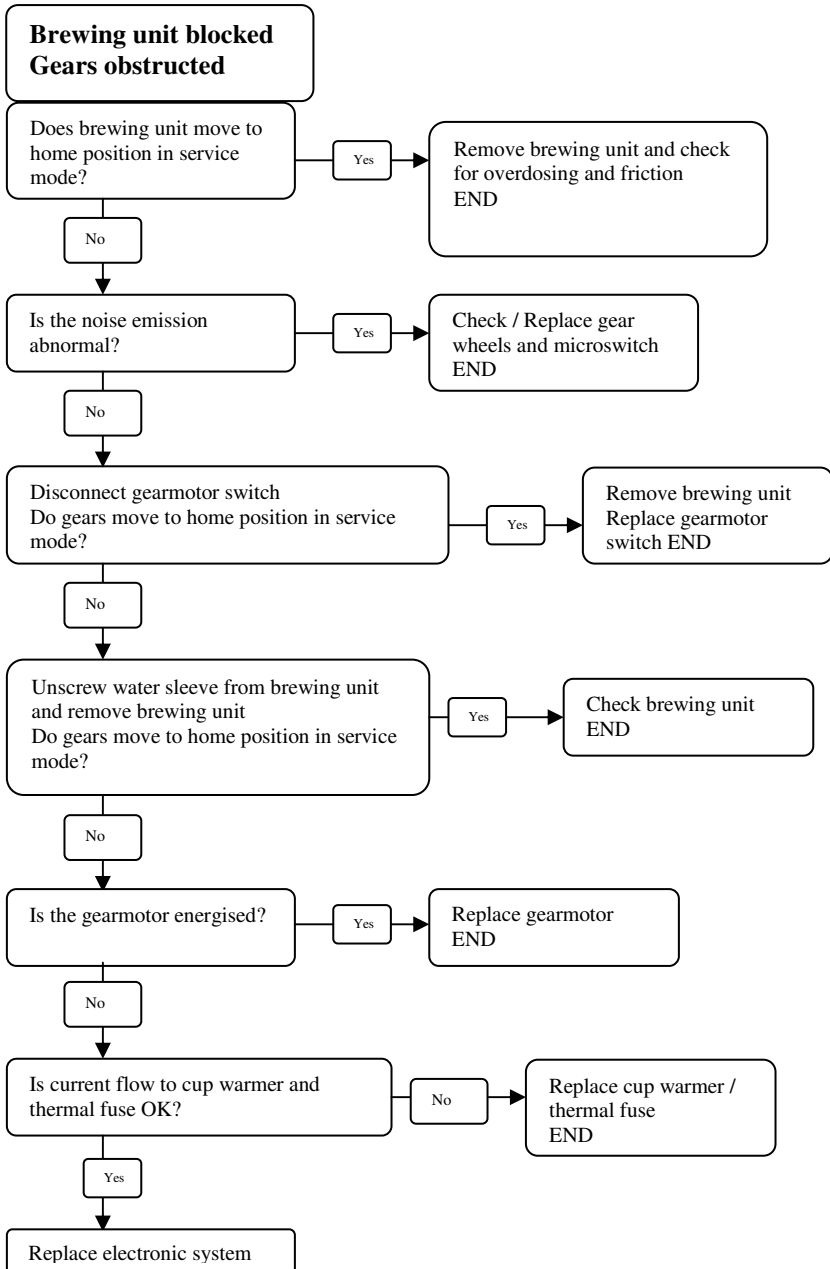

CHAPTER 8

REPAIRS /

SERVICE SCHEDULE

	Page
1. Repairs schedule	1
2. Service schedule	1
3. Final test	2

1. Repairs schedule:

The repairs schedule, together with the service schedule, lists all relevant activities to be performed in an efficient sequence.

	Activity
1	Visual check (transport damage)
2	Record of machine data
3	Functional check / Error analysis
4	Opening of machine
5	Visual check (leakages)
6	Mechanical systems check (functional test)
7	Defect detection
8	Modifications check
9	Service operations according to service schedule
10	Internal cleaning
11	Functional test (with open machine / leakage test)
12	Assembly
13	Final test according to test schedule
14	Steam off (winter)
15	External cleaning
16	Lubrication of brewing unit
17	Insulation test
18	Documentation

2. Service schedule:

Service activities

R = Replace

AT = Acoustic test

C = Clean

D = Descaler

VC = Visual check

A = Adjustment

Component	Activity	Equipment
Water filter	R	
Lip seal / Water tank	R	
Coffee return flow valve	R	
Valve spring	R	
Valve plug O-ring	R	
Valve plug O-ring	R	
Filter (brewing unit)	C / VC	Grease solvent
Hose connections	VC	
Pump	VC / AT	
Gearmotor	AT / VC	
Grinder	C / A	Vacuum cleaner / brush
Doser	C	Vacuum cleaner / brush
Water circuit	D	Descaler (Saeco)
HWS valve	VC / R	
Water outlet (valve plug)	C	Grease solvent / brush
O-ring (boiler connection / instantaneous water heater)	R	

3. Final test:

Test	Procedure	Equipment	Instruction	Tolerance
Cup fill volume	2-3 cups on espresso setting	Measuring beaker	Equal quantity	15%
Cup fill volume	2-3 cups on coffee setting	Measuring beaker	Equal quantity	15%
Noise emission			Empirical value Standard noise	
Froth quantity	Carefully froth coffee in cup until froth separates		Froth cover must subsequently close completely	
Froth colour			Textured light brown	
Temperature	Measurement of dispensed coffee stream	Temperature - measuring device	84 °C	± 4 °C
Grind level	Check grain size of coffee grinds		See Training	
Hot water	Dispense hot water			
Steam function	Dispense steam			
Water Low indicator	Remove tank		Fill water tank indicator	
Grinds Container Absent indicator	Remove grinds container		Grinds Container Absent indicator	
Coffee Beans Low indicator	Start coffee programme - coffee bean container empty		Coffee Beans Low indicator	
Insulation test			HG 701	

CHAPTER 9

DISASSEMBLY

	Page
1. Disassemble housing	1
2. Disassembling the electronic system	3
3. Disassembling doser flap valve	4
4. Disassembling doser switch	6
5. Disassembling the grinder	7
6. Adjusting the grinder	9
7. Disassembling the grinder motor	11
8. Disassemble the instantaneous water heater	13
9. Disassembling the gears	15
10. Assembly/adjustment of instantaneous water heater	17
11. Disassembling the pump	18
12. Disassembling System 2 (Rapid steam)	19

1. Disassembly of the housing

- a) Remove: Driptray, dreg drawer, water tank and brew unit.
- b) Unscrew the bean container by removing the two screws (1). New models may have a additional housing screw below the bean container to be unscrewed.
- c) Remove the two screws (2) below the water tank (Torx/T10).

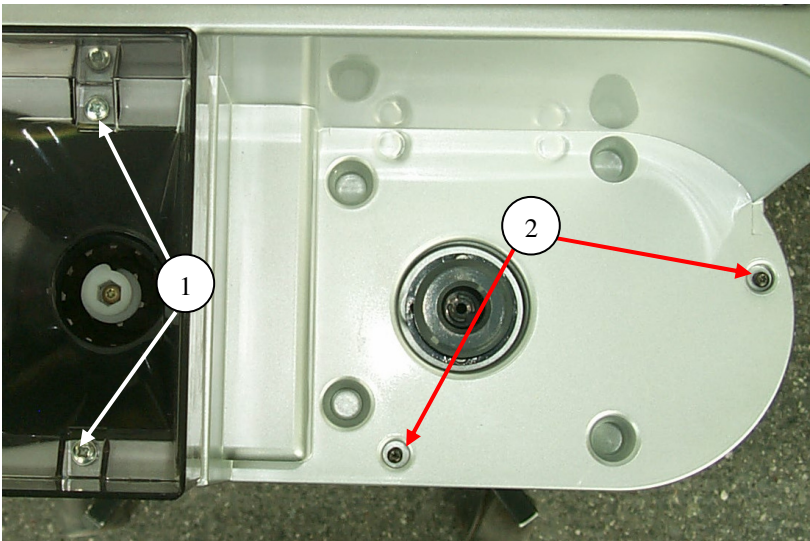

Fig. 1

- d) Remove the two bottom housing screws (1).

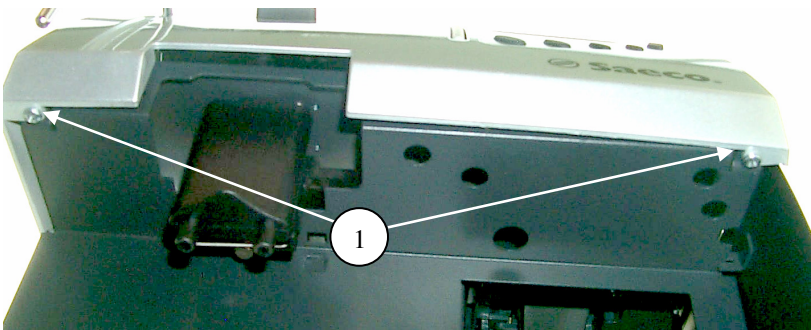

Fig. 2

- e) Release the two hooks by using a screw driver (1). Remove the grinder setting lever (2) carefully in order not to break the fixing hooks.

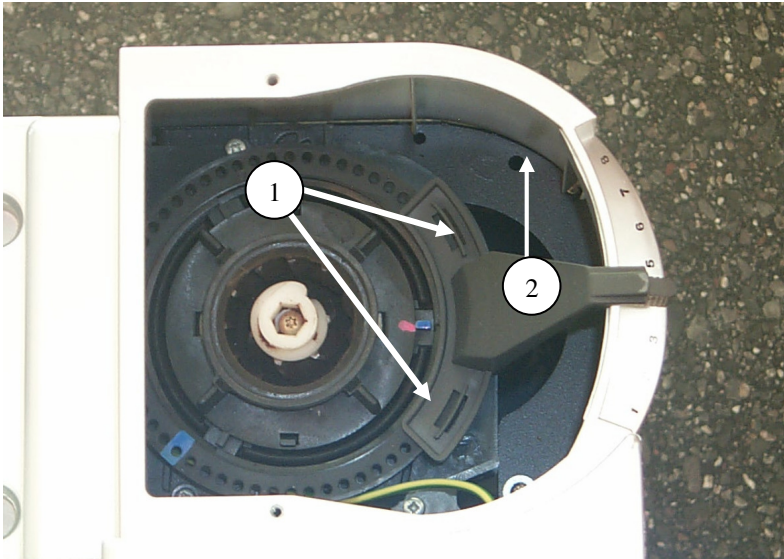

Fig. 3

- f) Lift the housing at the rear side and pull water hose off. Then remove the housing. **When reassembling make sure, that the water hose is connected correctly!**

2. Disassembling the electronic system

- a) Number the connections on the control board and remove.

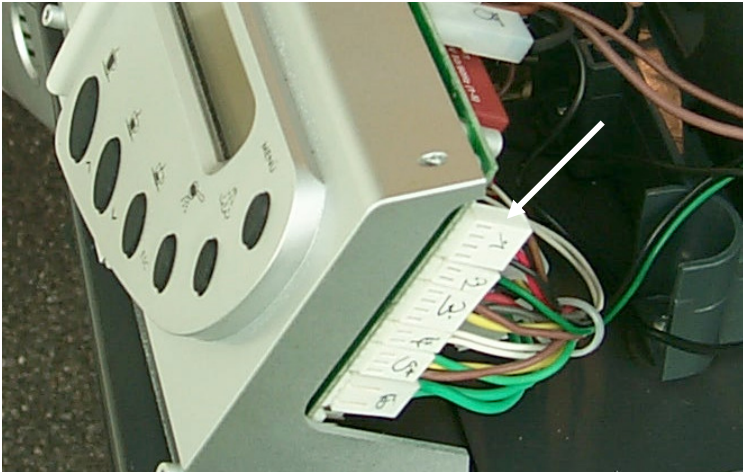

Fig. 4

- b) Unscrew the electronic system by removing the two fixing screws (1) and remove.

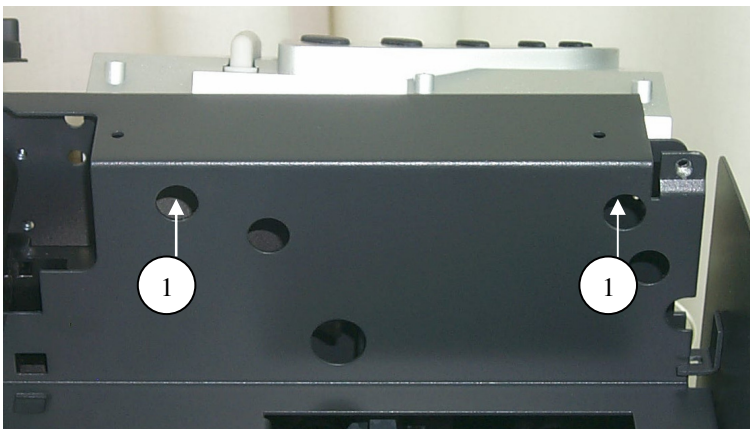

Fig. 5

3. Disassembling the doser

- a) Unscrew the doser cover by removing the screw (1).

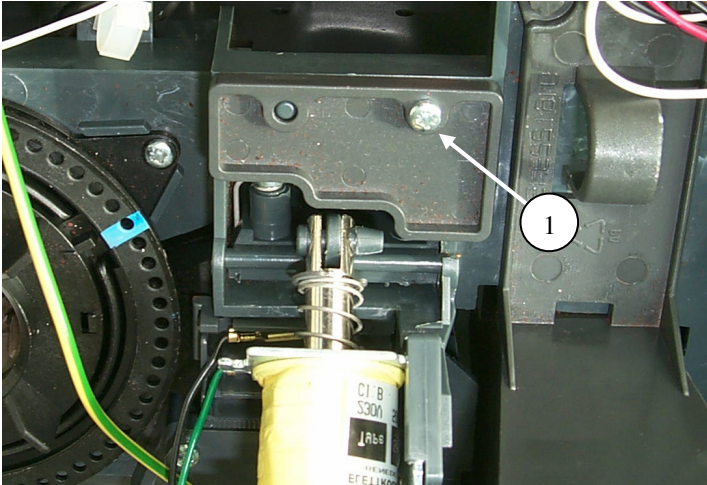

Fig. 6

- b) Using a screwdriver, release the fastening tab (1) and push dosing magnet out of its fitting.

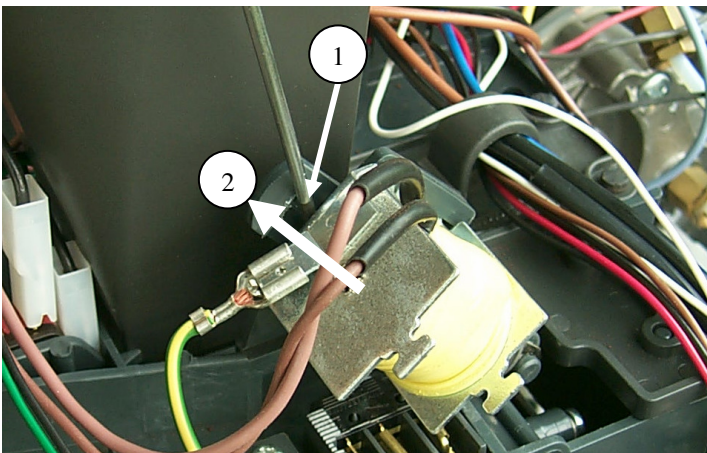

Fig. 7

- c) Using a screwdriver, first push the doser flap out of the open end (1). Then slide it out of the closed bearing (2) and remove.

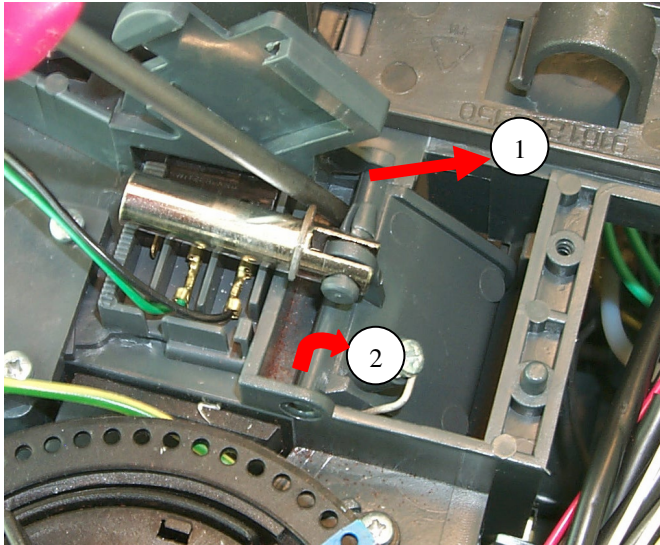

Fig. 8

4. Disassembling doser switch

- a) Push the powder coffee compartment in direction of the arrow (1) and lift it (2). Carefully pull out the two rubber holders (3).

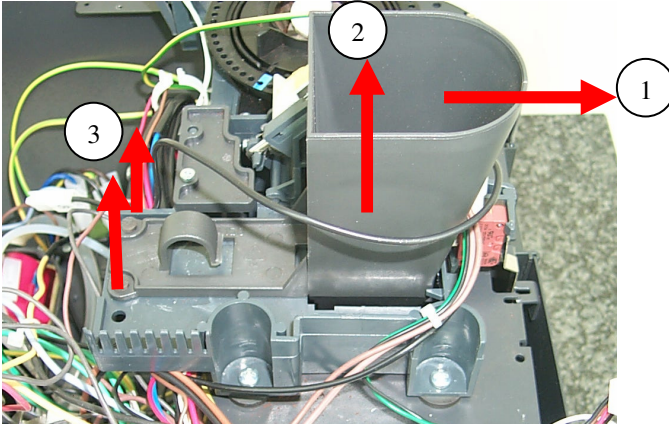

Fig. 9

- b) Disconnect the switch. Lift the doser switch using a screwdriver (1) and push it out of its fitting (2).

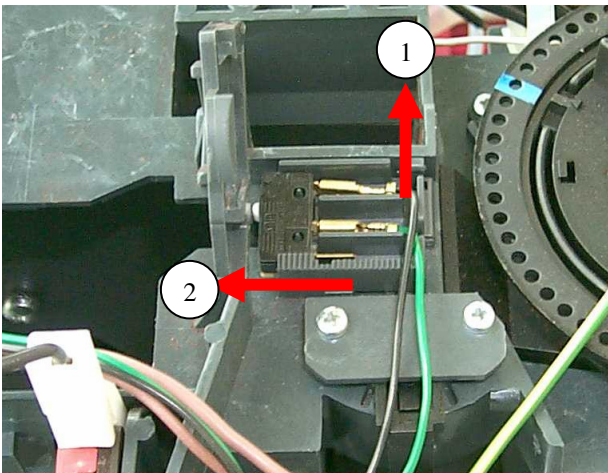

Fig. 10

5. Disassembling the grinder

- a) Turn the grinding adjustment ring (1) counter clockwise until the three lugs of the grinding disc fitting (2) are clearly visible and remove the upper grinding disc from the grinder. Using a vacuum cleaner remove the ground coffee.

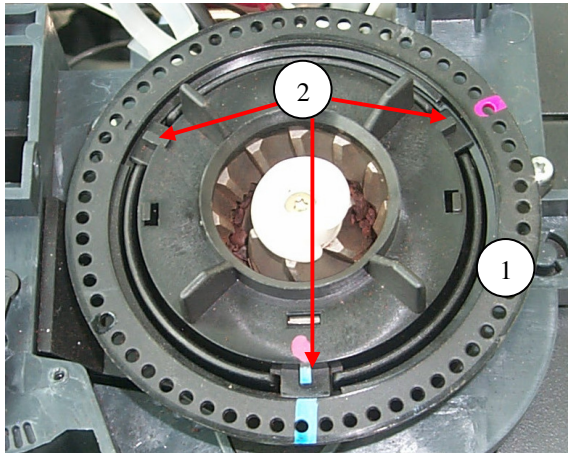

Fig. 11

- b) Remove the fixing screw (1) of the grinding cone (note: left thread).
- c) Carefully remove the grinding cone (2) (take care of balls and springs of friction clutch).

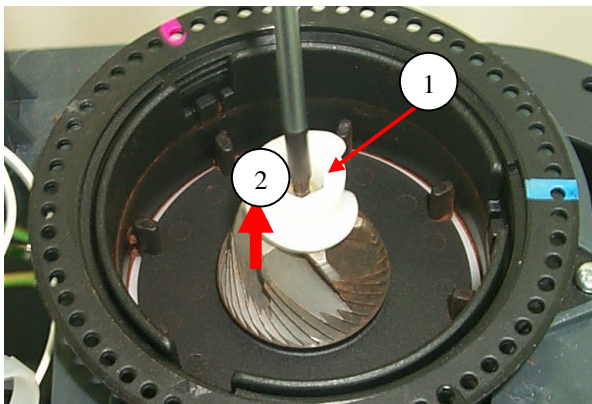

Fig. 12

- d) Carefully remove the clutch disc.

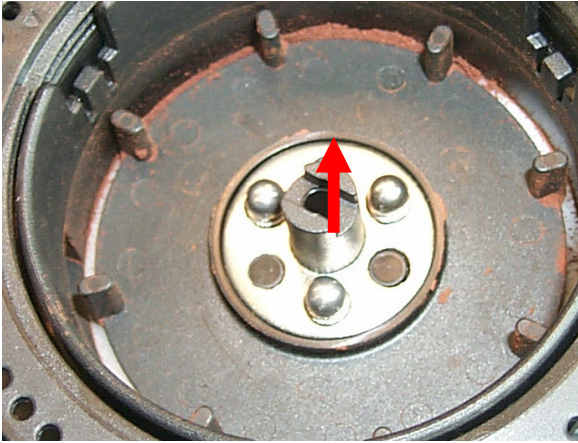

Fig. 13

- e) Remove: Balls, springs and rubber drivers. The sealing felt (1) can then be cleaned or exchanged. (Same steps have to be performed when exchanging the Grinder motor)

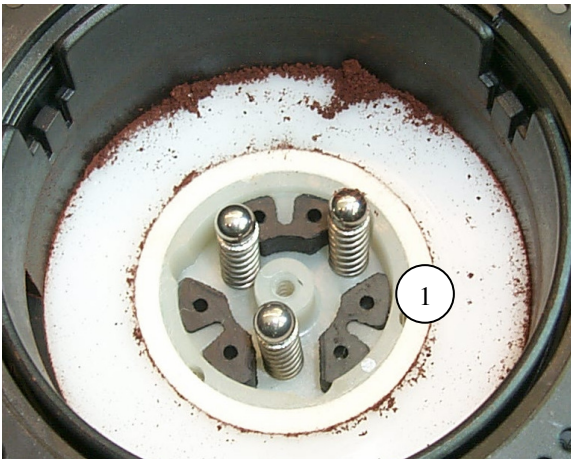

Fig. 14

6. Adjusting the grinder

- a) Install the grinding ring onto its fitting so that the marking (1) on the grinding adjustment ring and the ring fitting (2) are adjacent to one another.

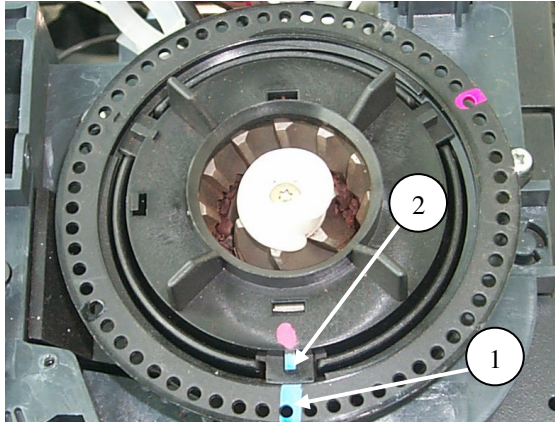

Fig. 15

- b) Turn the grinding adjustment ring (1) clockwise until a certain friction can be felt.

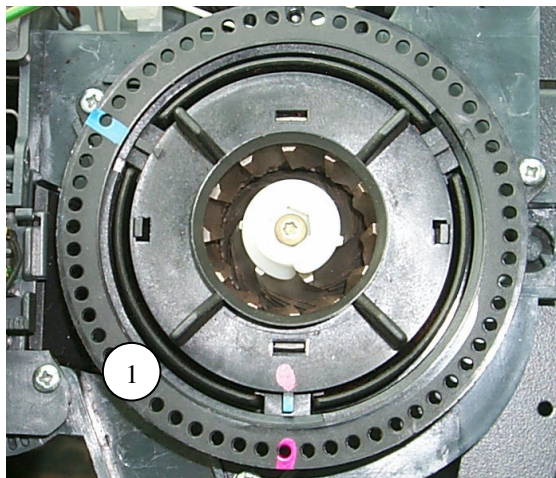

Fig. 16

- c) Turn about 12-14 notches in an anti-clockwise direction and check the grind level by making a test coffee (Crema / dregs grain size). Adjust the grind level as required (max. 3-5 notches). Attach the housing and mount the lever in position 5.

7. Disassembling the grinder motor

- a) If the motor has to be exchanged perform according to description 6. Disassembling the grinder first. Remove the three fixing screws (1), and set the doser switch to max position.

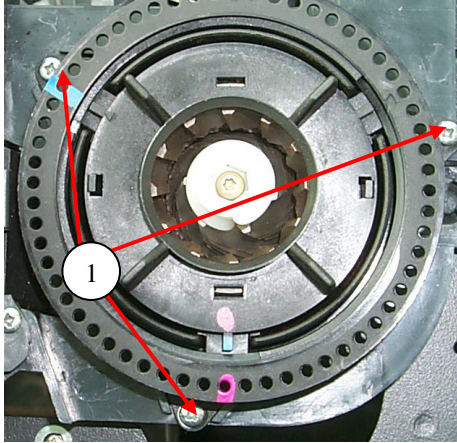

Fig. 17

- b) Lift the motor and disconnect the connectors (1).

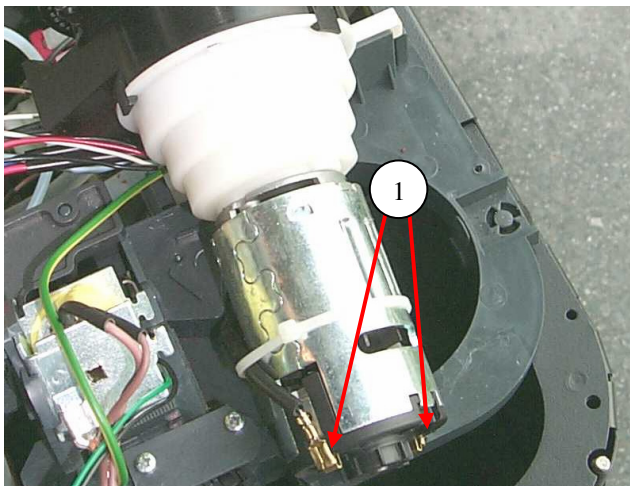

Fig. 18

- c) Remove the securing ring if there is one (not in all machines), unhook the three tabs and separate the upper part from the motor/gear assy (the motor is always delivered with the gear).

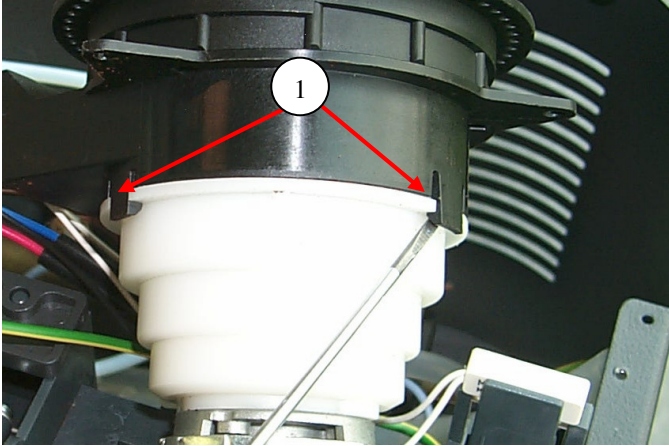

Fig. 19

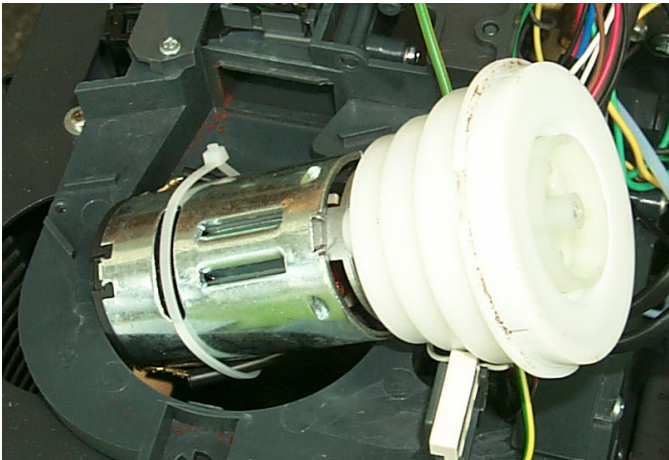

Fig. 20

8. Disassembling the instantaneous water heater

- a) Remove the hose clip of the HWS-valve (1) and the instantaneous water heater (2) and remove the Water hose.

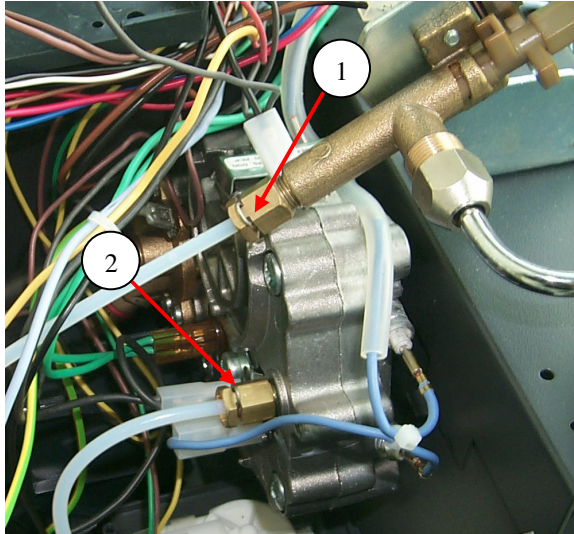

Fig. 21

- b) Remove the two fixing screws (1) of the instantaneous water heater (new version / boiler J is fixed with 3 screws).

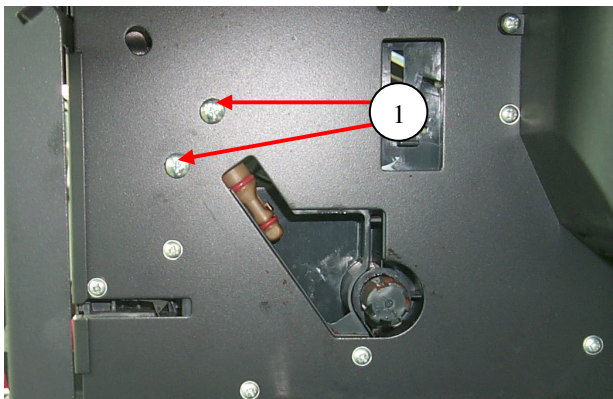

Fig. 22

- c) Lift the heater out of the machine and exchange parts as necessary. In order to exchange the thermostat or the sensor, remove screw (1) and the fixing clamp.

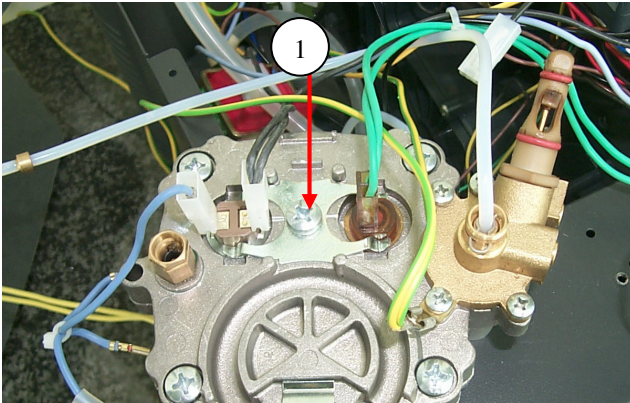

Fig. 23

- d) **Attention:** The metal cylinder (Fig. 24/1) of the thermal sensor (KTY) must be transferred from the old sensor to the new sensor when the sensor is replaced!.

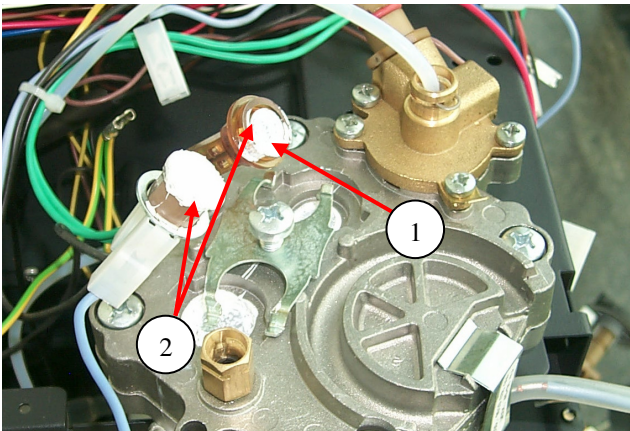

Fig. 24

- e) When re-assembling ensure that sufficient heat conductive paste is used (Fig. 24/2).

9. Disassembling of the gear

- a) Remove the housing
- b) Remove loosen the instantaneous water heater
- c) Remove the gear fixing screws (1).

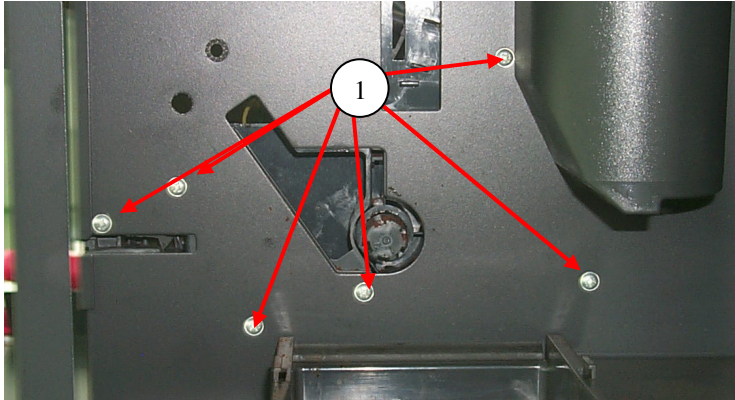

Fig. 25

- d) Remove the gear by lifting it a bit – pulling out the bottom side of the gear first, and thereafter the upper side. Unscrew the screws of the gear cover and remove the cover.

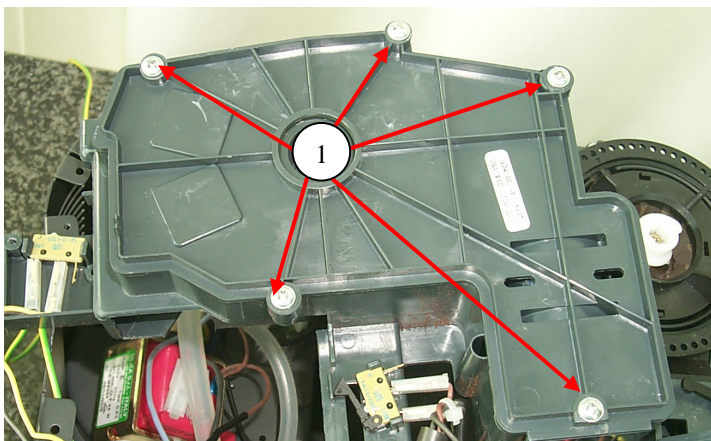

Fig. 26

- e) Replace parts as necessary.
 - f) When replacing the gear wheel ensure that the arrow on the large gear wheel points towards the achsle of the small gear wheel. The brewing unit cannot be installed in this position. (Install all components, switch on machine - gears go to home position - install brewing unit.) The small gear wheel can be assembled as required
-
- a) Micro switch brew position
 - b) Micro switch home position
 - c) Micro switch dreg drawer
 - d) Micro switch brew unit



Abb. 27

10. Assembly/adjustment of instantaneous water heater

- a) Screw on the instantaneous water heater, but do not fasten the screws completely. Insert the brew unit and drive it into brew position using the test mode. Fasten the lower fixing screw (1).

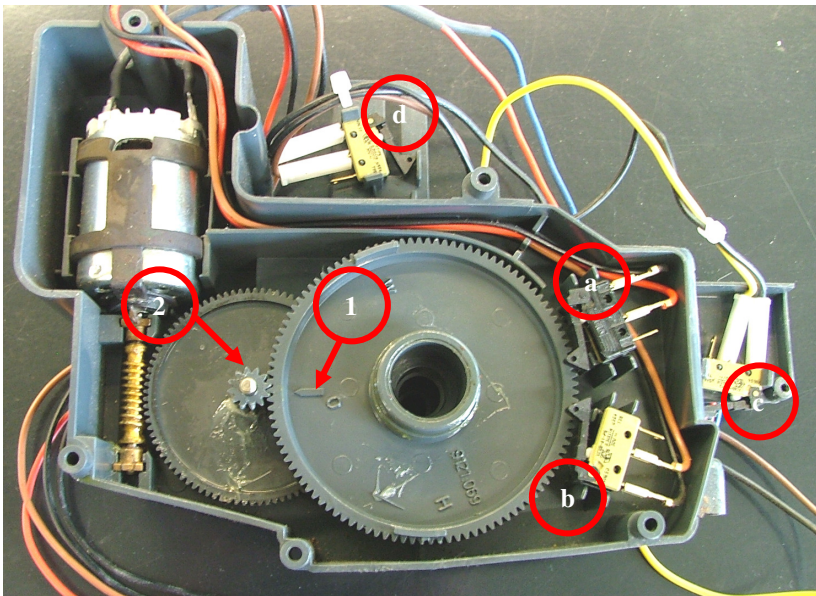

Abb. 28

- b) Drive the brew unit into home position, remove the brew unit and fasten the upper screw (1). (Attention: Boiler J is fixed with three screws)

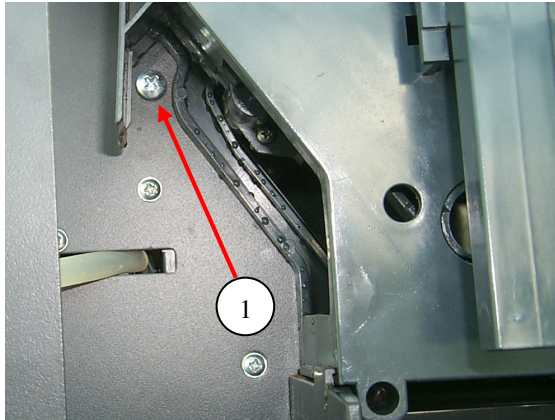

Abb. 29

11. Disassembling the pump

- a) Pull off the adapter angle (1) and pump holder (2).

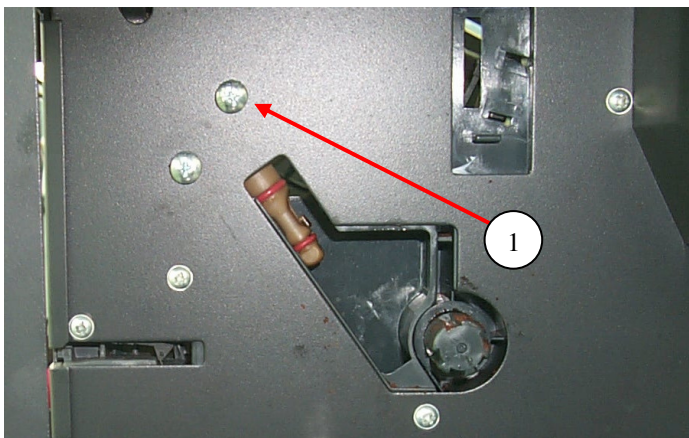

Abb. 30



Abb. 31

- b) Remove the locking spring (1).
c) Push down the fixing tab (2) and remove pump and holder (3).

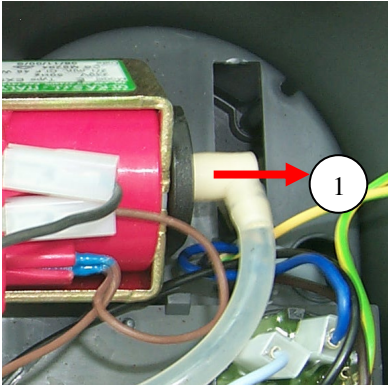

Abb. 32

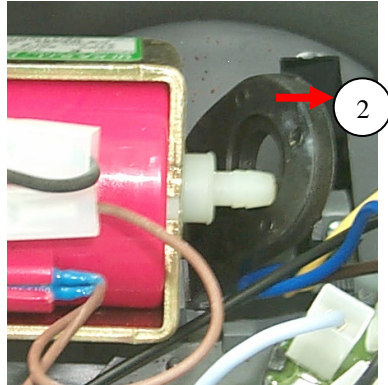
12. Disassembly System 2 (Rapid steam)

- a) Loosen nut (1) and remove cappuccino valve.

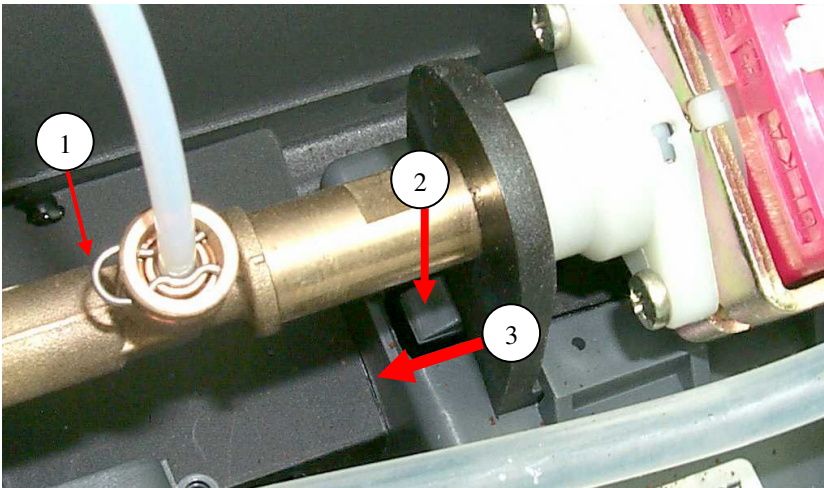

Abb. 1

- b) Unscrew system two holding device, by removing the five screws (1).

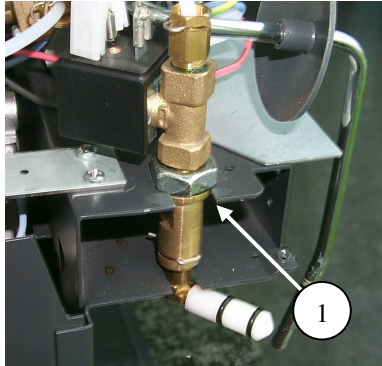

Abb. 2

- c) Lift system two as much as possible and remove the hose (1) from the pressure relief valve

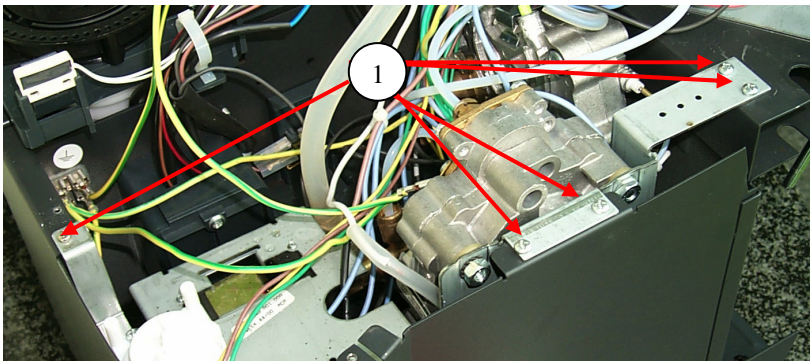

Abb. 3

- d) Remove the locking spring of the steam hose and remove the steam hose (1). Place the unit on the rim of the housing and change parts as necessary.

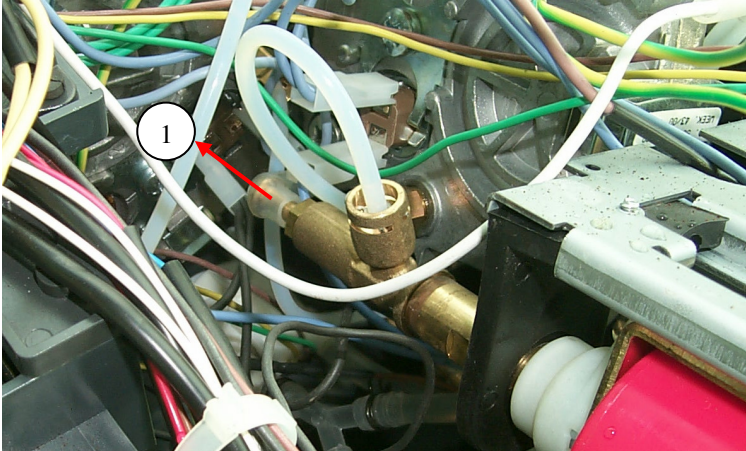

Abb. 4

CHAPTER 10

CIRCUIT DIAGRAMS

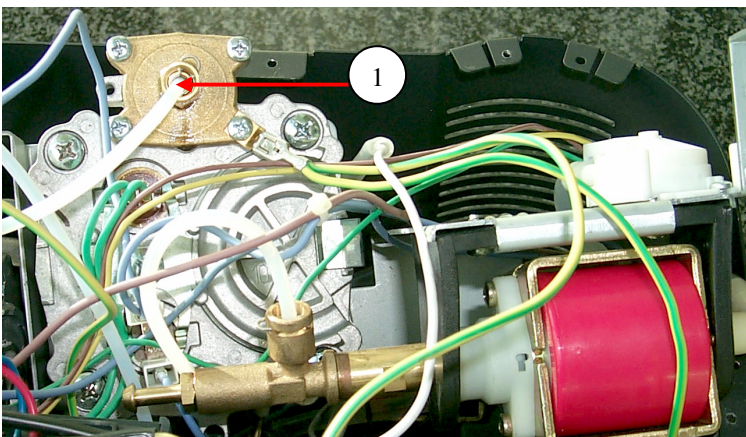