

PHILIPS

Service
Manual



PERFECT CARE EXPERT PLUS STEAM GENERATOR

**GC 8930
GC 8960**

**GC 8940
GC 8962**

GC8942

GC8950

GC8952

Contents

	Page
1. Important Repair Instructions	3
2. Product Information	
- Product Matrix	6
- Functions/ Features Information	7
- Wiring Diagram	8
3. Troubleshooting	10
4. Disassembly and Reassembly Instructions	12
5. Service Lists	24
6. Revision History	37

Important Repair Instructions

V4

1. Only skilled personnel should carry out the repair.
2. Verification test to carry out as follows, to determine the problem:
 - a. Ensure product are properly assembled
 - b. Power on
 - c. Water Tank to be filled up to **Maximum** level
3. Refer to Trouble shooting guide for part repair/replacement.
4. Specific tool needs to be used for the following part replacement.
 - a. Inox Clamp – Refer to page 21
 - b. Electrovalve – Refer to page 22
5. After repaired, the appliance must function properly, following test to be carried out:
 - a. **POWER-ON CHECK**
Powered-ON with socket equipped with Residual Current Circuit Breaker (RCCB) or Earth Leakage Circuit Breaker (ELCB) to ensure no electrical hazard risk to end consumer.
 - b. **Soleplate temperature**
Check the soleplate temperature at maximum setting within IEC requirement.
Measure the temperature of the Soleplate after the iron has reached steady state i.e connected to the mains for at least 15 minutes. The table below shows the temperature requirement.

Soleplate temperature (Deg C)	
Minimum	Maximum
135 Deg C	155 Deg C

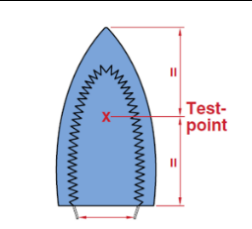

- c. **Water leakage**
Check that there is no water leakage from any part of product during operation.
 - d. **Functionality**
Check the functionality of the product such as:
 - Steaming
 - PCBA (Refer to point 6).
 - Buttons: no sluggish, no jammed and loosennes
6. **Loose part**
Check that there are no loose parts such as extra screws in the product that can cause short circuit or product malfunction.

Important Repair Instructions (Continue)

7. Self-Check mode

Self-Check mode is NOT an exhaustive diagnosis, but a quick preliminary check on all the hardware function.

7.1 The following to be carried out before Self-Check mode:

- i) Power meter should be in-placed to monitor system power.
- ii) Minimum water level in the water tank
- iii) Make sure Soleplate is <100°C

V4 7.2 Reset product to Factory Mode Test (FMT) Flow

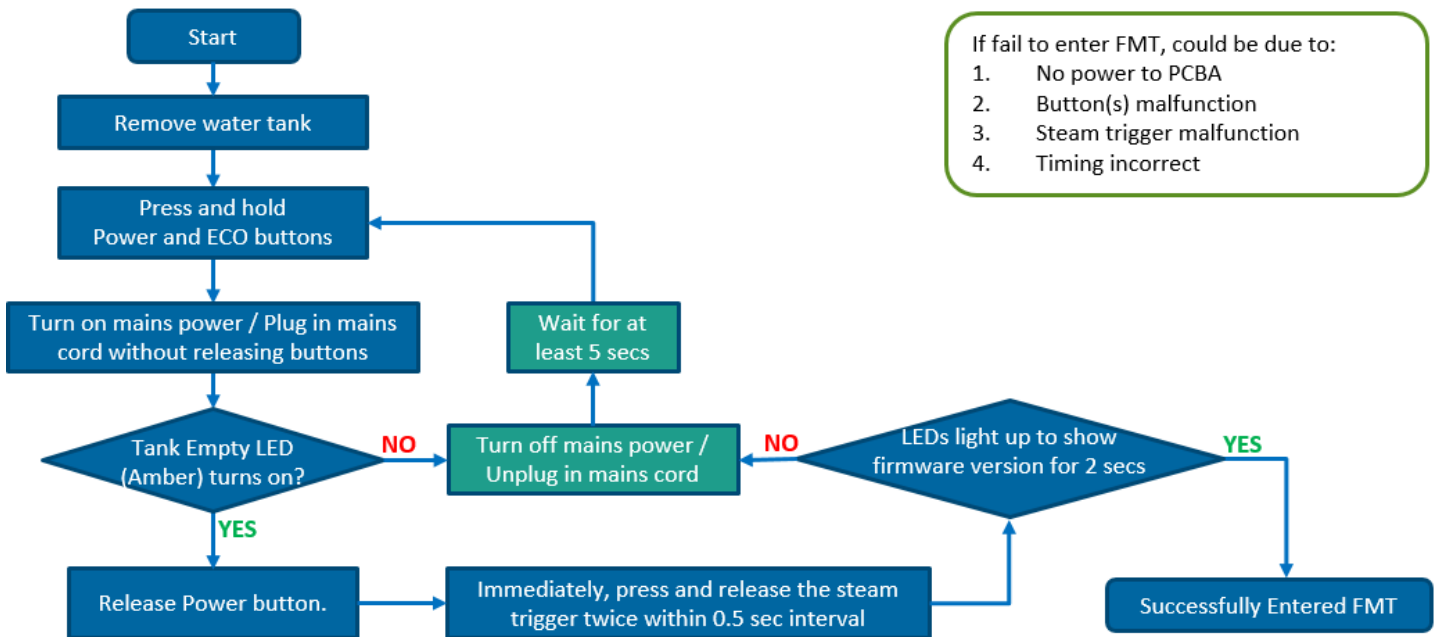

Important Repair Instructions (Continue)

7.3 Process Self Check Mode, start Self Check Mode

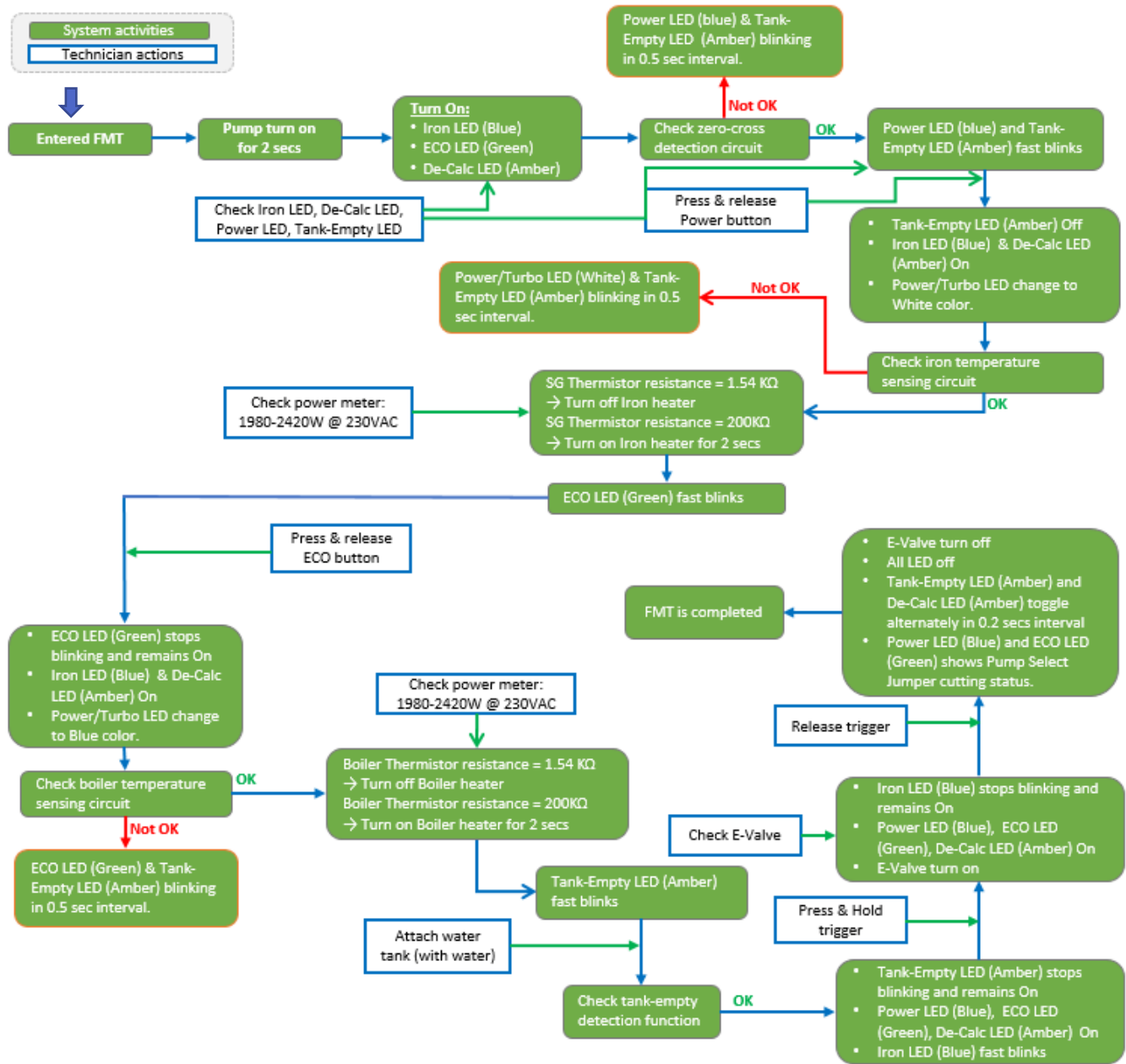

Product Information

Product Matrix



Model Number	GC8930	GC8940	GC8942	GC8950	GC8952	GC8960	GC8962
Voltage	220~240V	220~240V		220~240V		220~240V	
Frequency	50~60Hz	50~60Hz		50~60Hz		50~60Hz	
Power	Max 2100W	Max 2100W		Max 2100W		Max 2100W	
Continuous Steam (g/min)	120g	120g		120g		120g	
Pressure (bar)	7	7.5		7.5		7.5	
Steam Boost (g)	450	470	480	500	520	500	520
Optimal TEMP	Yes	Yes		Yes		Yes	
Vertical Steam	Yes	Yes		Yes		Yes	
Steam Ready Time (min)	2	2		2		2	
Soleplate Coating	SteamGlide Advanced	SteamGlide Advanced		SteamGlide Advanced		SteamGlide Advanced	
Anti Calc	Easy-de-calc	Easy-de-calc		Easy-de-calc		Easy-de-calc	
ECO	Yes	Yes		Yes		Yes	
Turbo	Yes	Yes		Yes		Yes	
Water Tank (ml)	1800	1800		1800		1800	
Carry Lock	Yes	Yes		Yes		Yes	
Safety Auto Off	Yes	Yes		Yes		Yes	
Accessories	No	No		No		No	
Cord length (M)	1.65	1.65		1.65		1.65	
Dimensions (H x W x D) - mm	269 x 426 x 239	269 x 426 x 239		269 x 426 x 239		269 x 426 x 239	

Product Information

Functions/ Features Information

Fast & Powerful Crease Removal

- Soleplate: SteamGlide Advanced
- Optimal TEMP Technology
- Safe rest
- Silient Steam Technology
(for GC8960 & 8962 only)
- Vertical Steam
- Variable Steam Settings
- Steam Output Control
- Steam Tip
- Steam on demand

Calc Management

- Suitable for tap water
- Calc Clean solution: Easy-De-Calc
- Descaling reminder: Light

Easy to use

- Filling and emptying water: Detachable Water Tank, Extra large filling hole
- Refill any time
- Lower water level alarm
- Heat up time: 2 min
- Safety auto off
- Light and comfortable
- Open handle
- Safe for all fabrics: Even for delicates such as silk material.
- Cord freedom, Swivel 180 degree

Storage

- Storage solution: Carry Lock
- Hose Storage: Hose storage compartment
- Cord storage: Velcro fix

Sustainability

- ECO setting
- Energy saving: 45% energy reduction

Product Information (Continue)

Wiring Diagram - Iron

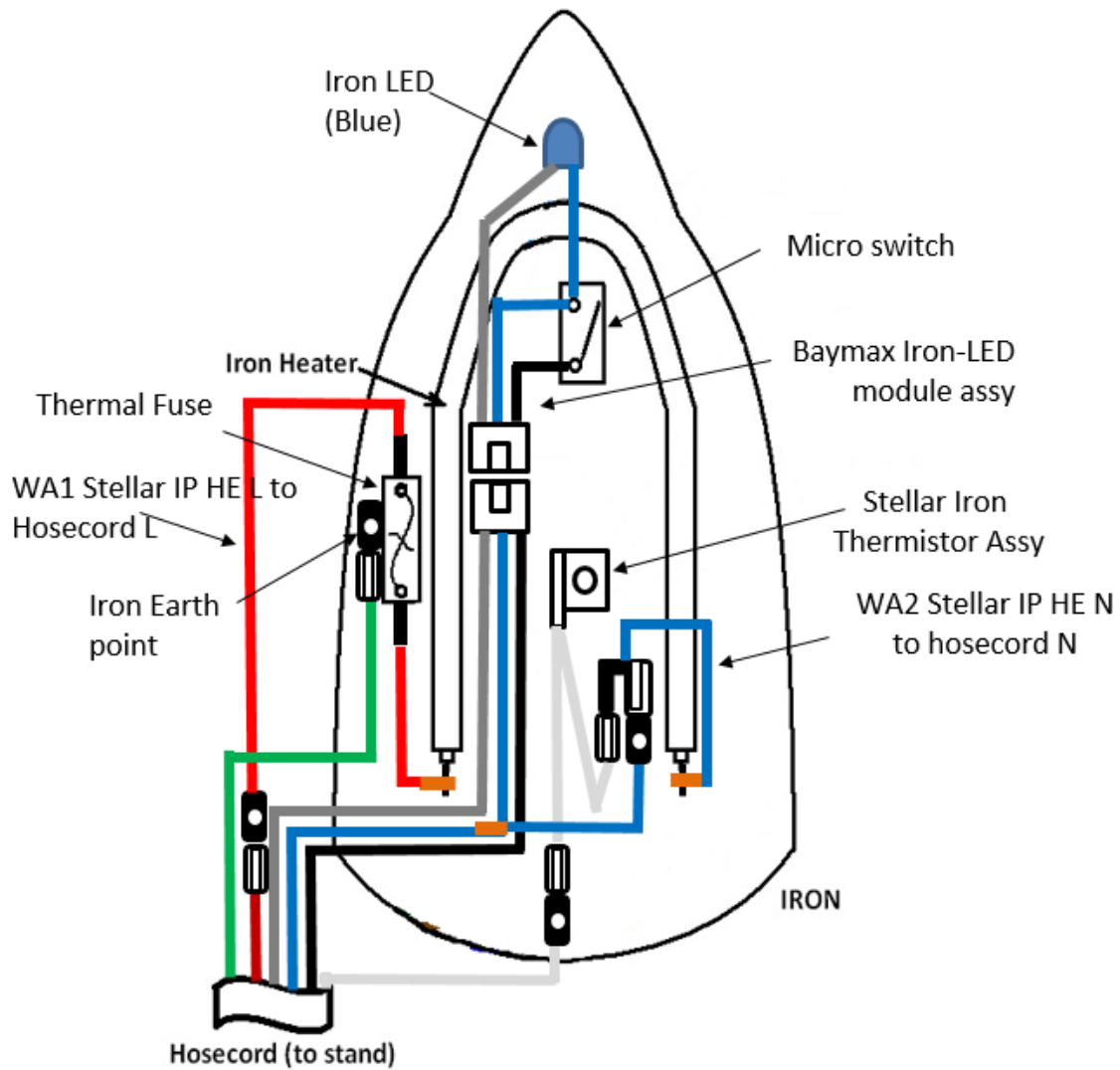

Product Information (Continue)

Wiring Diagram - Stand

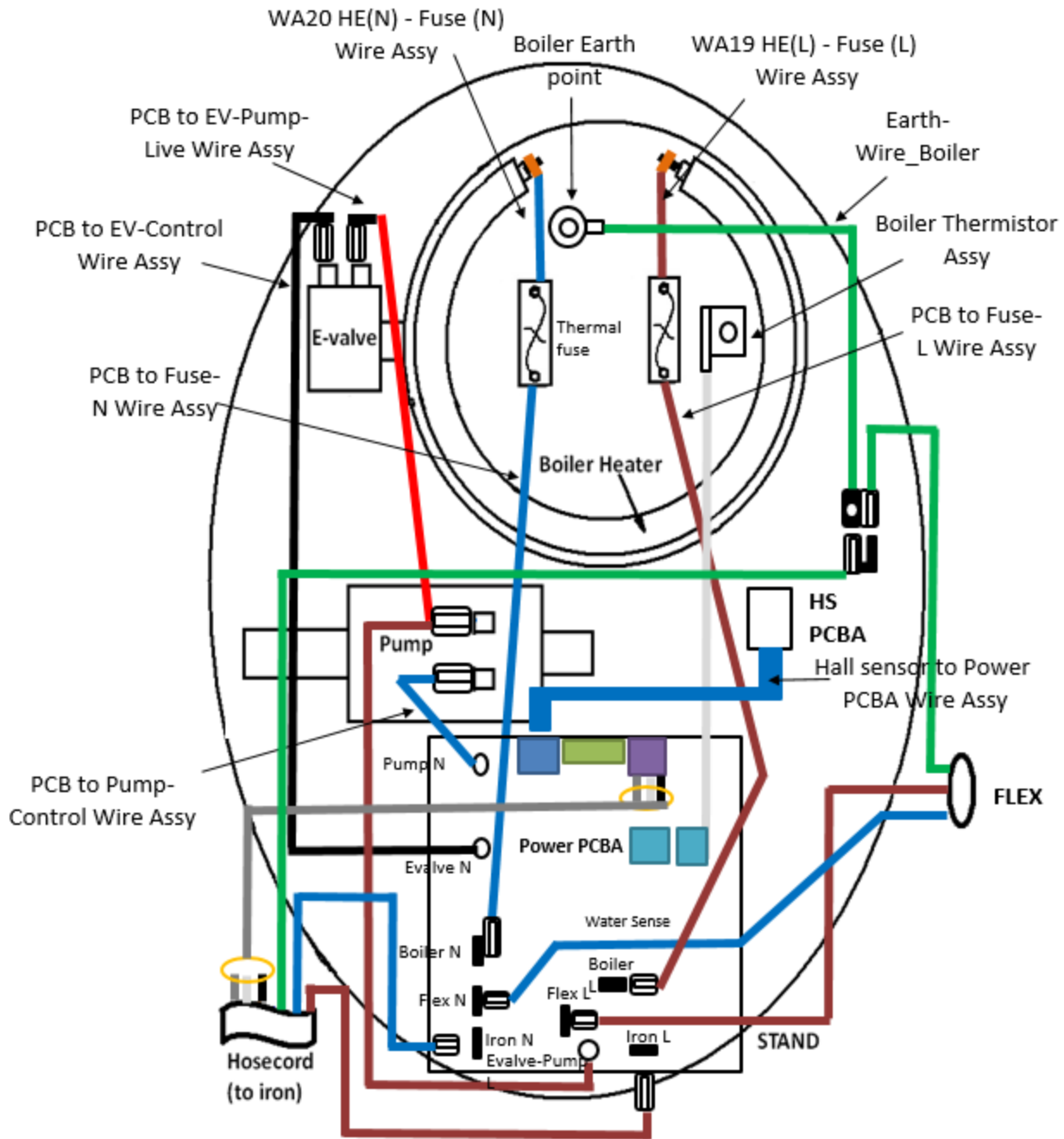





Troubleshooting

Problem	Possible root cause	Solution
Iron LED does not light up as specified (refer to page 5)	Hose Cord Assy wiring Iron LED Assy Hose Cord Assy Power PCBA	Reconnect & retest Change Iron LED Assy Change Hose Cord Assy Change Power PCBA*
Other LEDs do not light up as specified (refer to page 5)	Power PCBA	Change Power PCBA*
Empty Tank LED always blinking (refer to page 5)	Water Tank Assy Hall Sensor Assy Power PCBA	Change Water Tank Assy Change Hall Sensor Assy Change Power PCBA*
Zero-crossing detection circuit error (refer to page 5)	Power PCBA	Change Power PCBA*
Iron temperature sensing circuit error (refer to page 5)	Connection Power PCBA Soleplate Assy	Reconnect & retest Change Power PCBA* Change Soleplate Assy
Iron heater power does not meet as specified (refer to page 5)	Iron is too hot Soleplate Assy PCBA	Cool down and retest Change Soleplate Assy Change Power PCBA*
Boiler temperature sensing circuit error (refer to page 5)	Connection Boiler Assy Power PCBA	Reconnect & retest Change Boiler Assy & Inox Clamp Change Power PCBA*
Boiler heater power does not meet as specified (refer to page 5)	Boiler is too hot Boiler Assy PCBA Mainscord	Cool it down and retest Change Boiler Assy & Inox Clamp Change Power PCBA* Change Mainscord
Steam trigger pressed does not detected (refer to page 5)	Hose cord Assy connection Iron LED Assy Hose Cord Assy E-Valve Trigger Power PCBA	Reconnect & retest Change Iron LED Assy Change Hose Cord Assy Change E-Valve Change Trigger Change Power PCBA*
Water leaking from De-Calc area	Rinse Cap Assy engagement Rinse Cap Assy Rinse Bush Assy	Tighten and retest Change Rinse Cap Assy Change Rinse Bush Assy
Water leaking	Connection for water path Inlet Coupling Seal Inlet Coupling Assy Water Tank Assy Soleplate Assy Boiler Assy	Reconnect & retest Change Inlet Coupling Seal Change Inlet Coupling Assy Change Water Tank Assy Change Soleplate Assy Change Boiler Assy & Inox Clamp
Lock jammed	Front Lock Bracket Assy Front Lock Slider Assy	Change Front Lock Bracket Assy Change Front Lock Slider Assy
No pumping	Pump Assy Trigger Power PCBA	Change Pump Assy* Change Trigger Change Power PCBA*
Plastic molded part damaged, broken, short molding, cosmetic defect or sharp edges	Inlay 2K Assy MS LED Holder Housing Prted Trigger Chassis Housing Cap Tray Assy Tank Catch Spacer Top Spacer Bottom Stand Top Stand Botttom Assy Button Assy	Change Inlay 2K Assy Change MS LED Holder Change Housing Prted Change Trigger Change Chassis Change Housing Cap Change Tray Assy Change Tank Catch Change Spacer Top Change Spacer Bottom Change Stand Top Change Stand Botttom Assy Change Button Assy

Notes: * Refer to page 23 for Power PCBA/ Pump Assy replacement Reassembly Instruction

Troubleshooting

LED Blinking Error Signal Interpretation

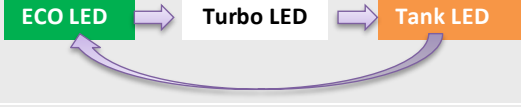
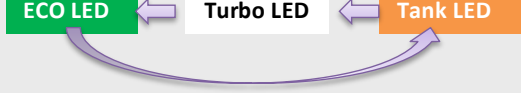
Error Detected		LED Indication	System
Over Heat	Iron Over Heat (> 200 °C)	Power LED (Blue) Fast Blink (400ms) 	OFF
	Boiler Over Heat (> 250 °C)	Turbo LED (White) Fast Blink (400ms) 	OFF
Thermistor Error	Iron Thermistor Short Circuit	ECO, Power, Tank LED scrolling clockwise 	OFF
	Iron Thermistor Open Circuit	ECO, Power, Tank LED scrolling anti-clockwise 	OFF
	Boiler Thermistor Short Circuit	ECO, Turbo, Tank LED scrolling clockwise 	OFF
	Boiler Thermistor Open Circuit	ECO, Turbo, Tank LED scrolling anti-clockwise 	OFF

Disassembly Instructions - Iron

Notes: ⚠ Before dismantling: Ensure the plug is disconnected from the mains and Soleplate is not hot.

1. Remove Screw A from **Housing Prted** 4
2. Remove Screw B from **Chassis** 7



3. Remove **Inlay 2K Assy** 1
4. Remove Screw C from **Micro Switch LED Assy**

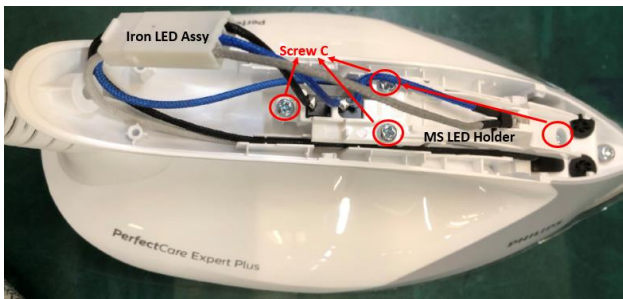

5. Remove **Iron LED Assy** 2
6. Remove **Micro Switch LED Holder** 3
7. Remove **Trigger** 5 & **Trigger Spring**



8. Remove Screw D in front of **Housing Prted** 4

9. Remove **Mica Washer**
10. Remove **Housing Prted** 4

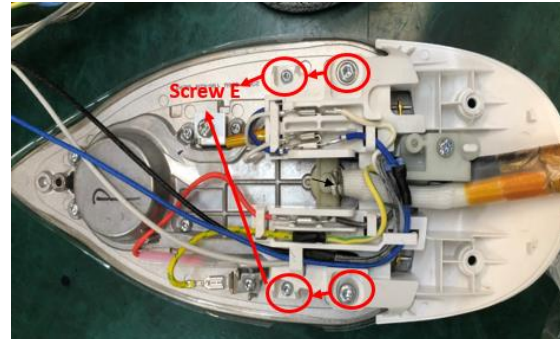

11. Remove Screw E from **Chassis** to **Soleplate**
12. Remove Screw F

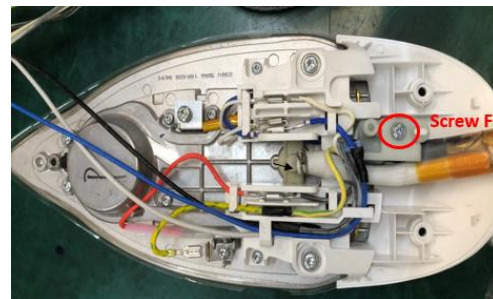

13. Disconnect all wire connection
14. Remove **Chassis** 7
15. Remove **Hose Clip**

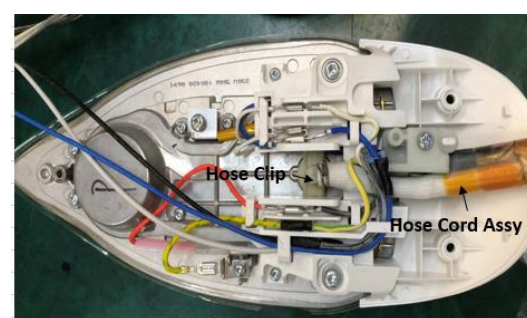

16. Remove **Hose Cord Assy** 6

Disassembly Instructions - Stand

1. Remove **Water Tank Assy** 10
2. Remove Screw G underneath the Tray Rubber



3. Remove Screw H from Stand Top



4. Remove Screw I from stand Bottom

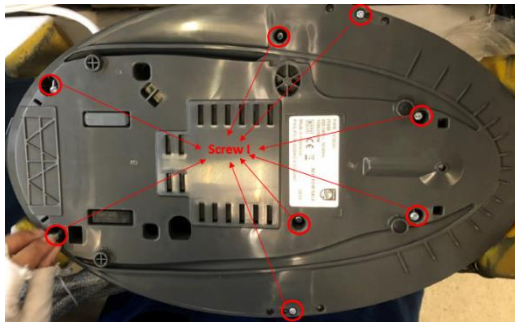

5. Remove **Tray Assy** 13
6. Remove **Rinse Cap Assy** 14
7. Remove **Rinse Bush Assy** 15
8. Remove Return Tube

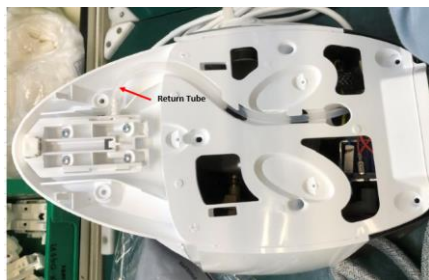

9. Remove **Stand Top** 23
10. Remove Screw R from Power Button

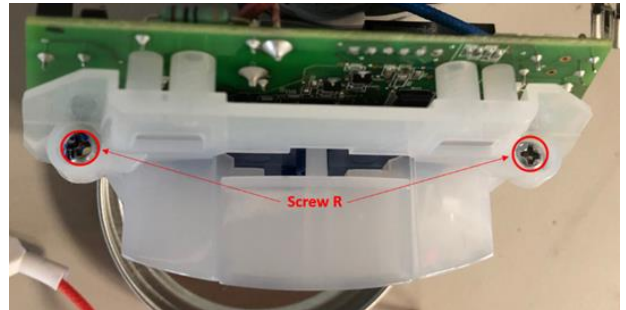

11. Disconnect all wire connection
12. Remove Hose Clip from **E-Valve** 22

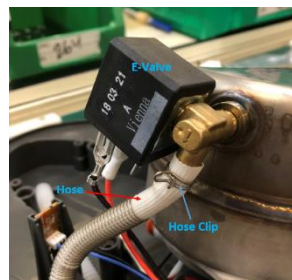

13. Remove Hose from **E-Valve** 22

14. Remove Screw J

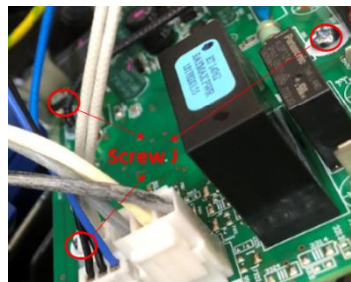

15. Remove **Power PCBA** 28
16. Remove **Power Button Assy** 29
17. Remove **Inox Clamp** 18
18. Remove Hose from **Boiler Assy** 20



Disassembly Instructions - Stand

19. Remove Screw L

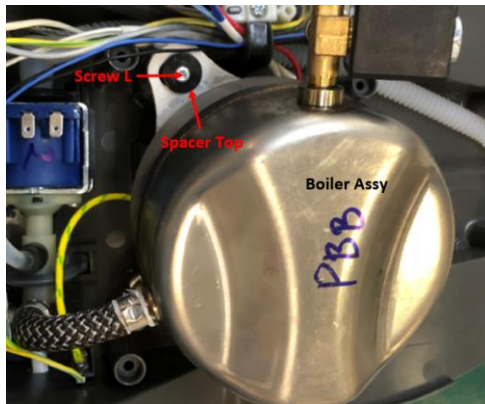

25. Remove Screw N

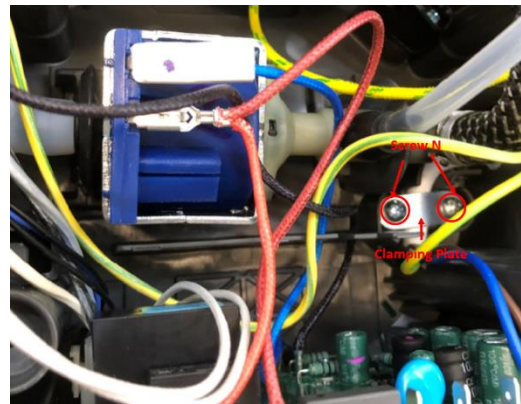

20. Remove **Spacer Top** 17

21. Remove **Boiler Assy** 20

22. Remove Screw M

23. Remove **Inlet Coupling Assy**

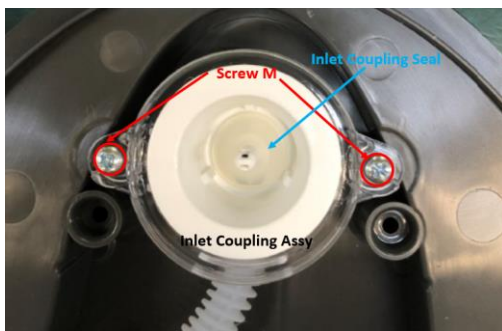

24. Remove Spacer Bottom

26. Remove Clamping Plate

27. Disconnect all wire connection

28. Remove **Mainscord** 30

29. Remove **Hall Sensor PCBA** 26

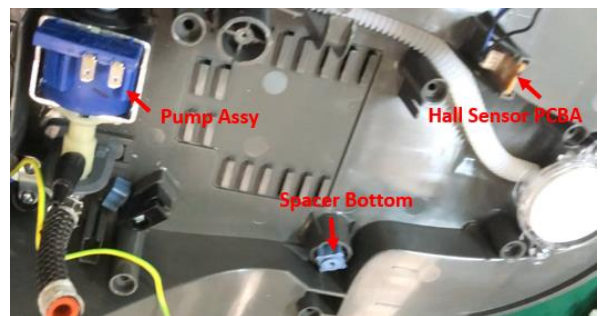

30. Remove **Pump Assy** 19

Disassembly Instructions – Lock Assy

Step 1: Use a screw driver to lift up the spring in the Lock Assy.

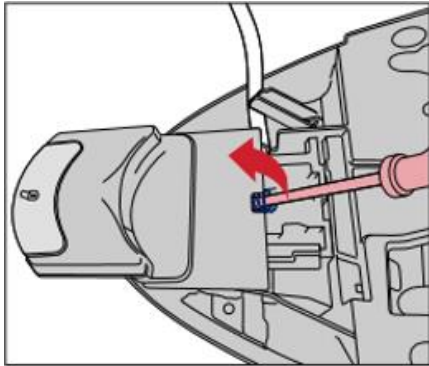

Step 2: Remove the lifted spring.

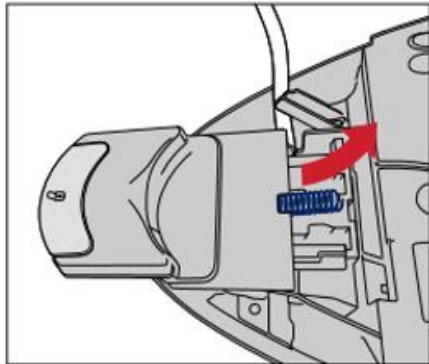

Step 3: Slide and lift up the Lock Assy

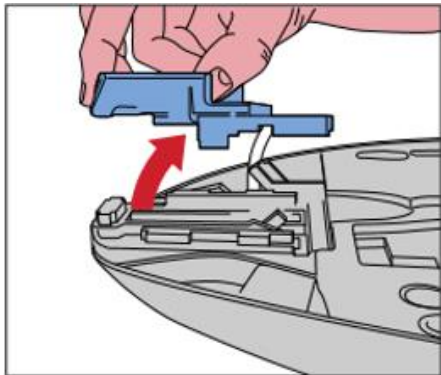

Reassembly Instructions (Continue) – Iron

Cautions:

- a. before fastening screw, relocate the screw with first thread. Once done fasten the screw.
- b. Do not drop, hit or knock the ASO/ PCBA. (ESD wrist strap & proper pack with ESD bag)
- c. Ensure there is click sound after Connector to Terminal engagement for wire connection.

1. Assemble Rubber Bung to **Housing Prted 4**
2. Assemble **Hose Cord Assy 6** to **Housing Prted 4**
3. Assemble Screw & fasten Screw P on Grommet



4. Assemble **Hose Cord Assy 6** to **Soleplate Assy 8**, lock with Hose Clip, assemble **Chassis 7**



5. Assemble Mica Washer, assemble & fasten Screw E
6. Assemble & fasten Screw F
7. Connect all wire per picture below.

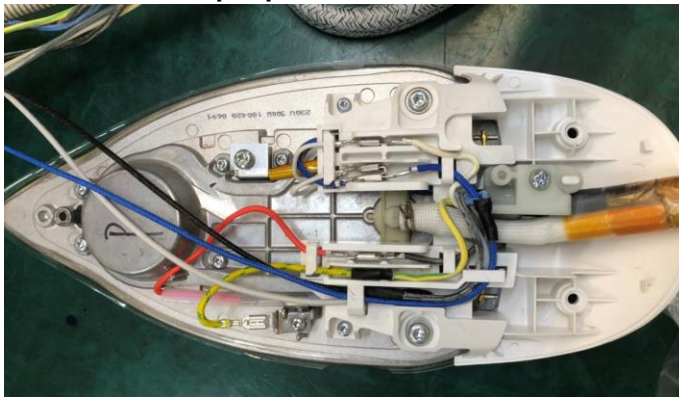

8. Assemble Ryton Ring
9. Assemble **Housing Prted 4**
10. Assemble & fasten Screw D
11. Assemble Rubber Support, **Trigger 5** and Trigger Spring
12. Dress wire according to wiring diagram below



13. Assemble **Iron LED Assy 2** to **MS LED Holder 3**, assemble to **Housing Prted 4**
14. Assemble & fasten Screw E
15. Connect wire (Micro Switch to Hose Cord)



16. Assemble **Inlay 2K Assy 1**
17. Assemble & fasten Screw A
18. Assemble & fasten Screw B

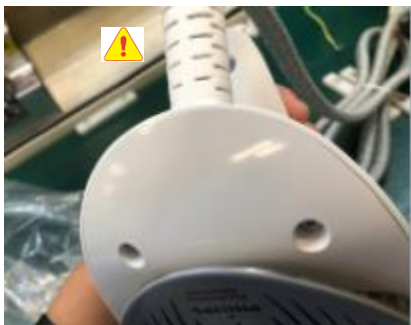

Reassembly Instructions (Continue) – Stand

1. Assemble Cord Clamp on to **Stand Bottom Assy** 27
2. Assemble & fasten Screw K
3. Assemble **Mainscord** 30
4. Assemble Clamping Plate, assemble & fasten Screw N

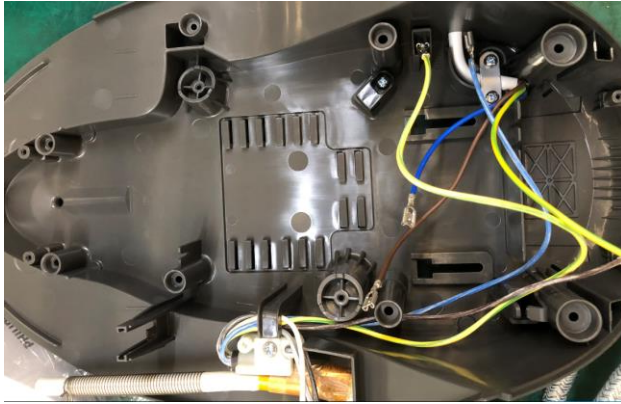

5. Assemble **Pump Assy** 19, dress corrugated Tube to **Stand Bottom Assy** 27

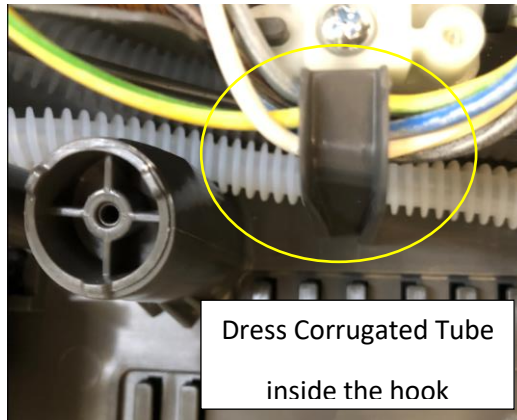
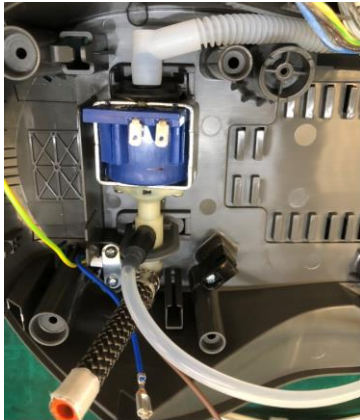

6. Assemble **Spacer Bottom** 21, assemble **Boiler Assy** 20
7. Connect all wire
8. Assemble **Hall Sensor PCBA** 26 and dress wire
9. Connect Hose to **E-Valve** 22, Lock Hose Clip with long nose plyer.



10. Connect Pump Assy's Braided Hose to Boiler's Water Inlet Collar, lock the Inox Clamp with Knipex Crimping Tool.



11. Assemble **Spacer Top** 17, assemble & fasten Screw L

12. Assemble **Power PCBA** 28 to **Button Assy** 29, assemble & fasten Screw J

13. Assemble & fasten Screw R

14. Assemble **Power PCBA** 28 & **Button Assy** 29, connect & dress wiring as shown.



15. Assemble **Inlet Coupling Assy** 25, **Inlet Coupling Seal** 24, Connect Corrugated Tube

16. Assemble & fasten Screw M

17. Assemble **Stand Top** 23, Connect Return Tube to **Front Lock Bracket Assy** 11

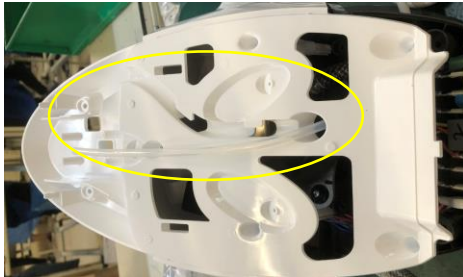

18. Assemble **Tank Catch** 16 & Tank Catch Spring

19. Assemble **Front Lock Bracket Assy** 11, assemble & fasten Screw Q

20. Assemble **Front Lock Slider Assy** 12 and Front Lock Slider Spring

21. Assemble **Tray Assy** 13, assemble & fasten Screw G



22. Assemble & fasten Screw I

23. Assemble **Rinse Bush Assy** 15

24. Assemble **Rinse Cap Assy** 14

25. Assemble **Water Tank Assy** 10



Reassembly Instructions

Crimping INOX CLAMP

Should BOILER ASSY, DE-AIR VALVE or BRAIDED HOSE BOILER are replaced, INOX Clamp must be replaced and following instruction to be followed.

Tool required: KNIPEX Crimp tool



Knipex Crimping tool

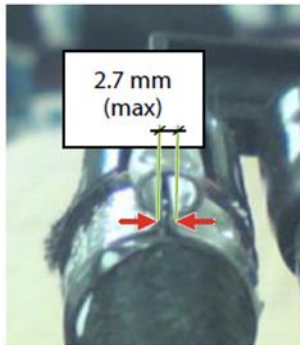

Direct crimp form

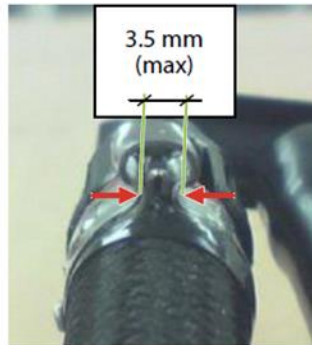

Fold in crimp

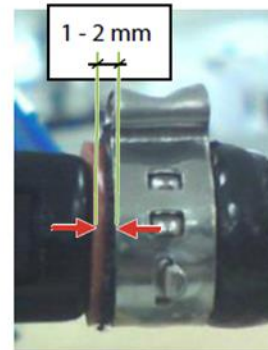

Distance from edge of crimp to rubber hose

CAUTION:

When crimping on plastic part such as DE-AIR VALVE, avoid over crimping to prevent damage (crack) to plastic part.

Reassembly Instructions

Replacing ELECTROVALVE

To prevent damage to the ELECTROVALVE during service activity, the following to be observed during disassembly & assembly.

Tool required: Torque wrench (set to 6Kgf)



CAUTION #1: The torque wrench engagement is allowed ONLY at the yellow box locations in below picture.

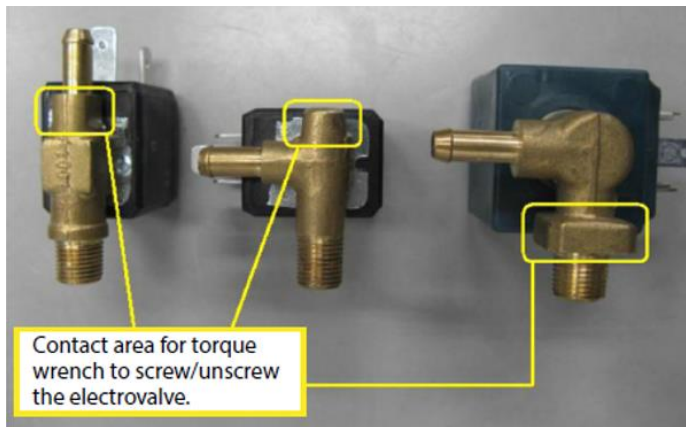

CAUTION #2: Ensure torque wrench jaw does not contact the solenoid body.

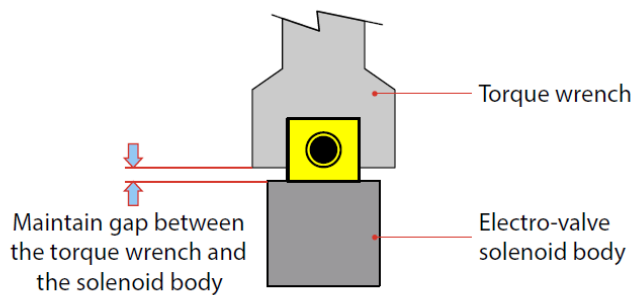

Reassembly Instructions

Power Board PCBA and / or & Pump Assy replacement.

In case of PCBA and / or pump replacement, follow as per below instruction to ensure matching of both hardware.

a) For PCBA replacement:

- To cut the jumper wires (J1, J2) on PCBA based on the pump label as in Table 1 below.

b) For pump replacement:

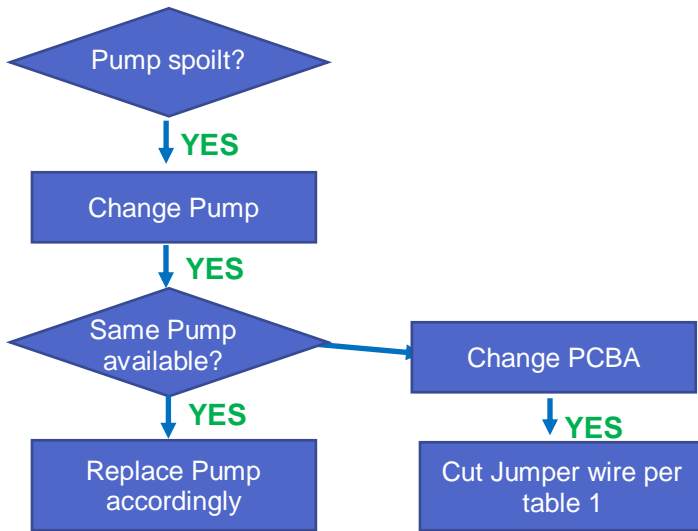
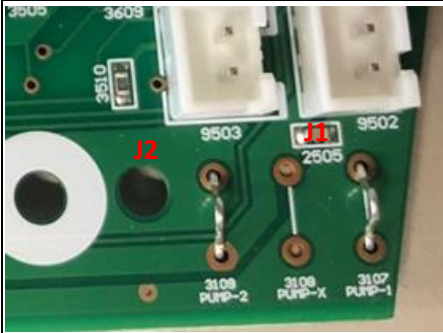
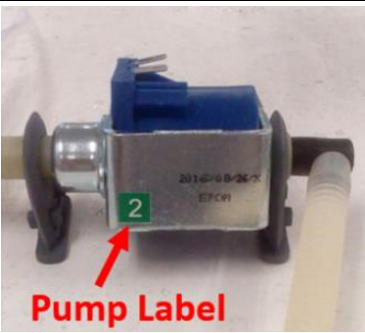
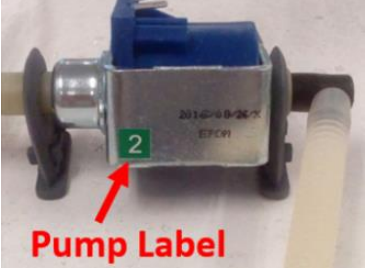

Table 1

Jumper wires on PCBA	Label on Pump	Pump label	Jumper wire to cut on PCBA
		1	J1 (Pump -1)
		2	J2 (Pump-2)

Service Lists

POS	DESCRIPTION	GC8930/10	GC8940/20	GC8940/20	GC8940/20
		889893010220 GERMANY	889894020010 BENELUX	889894020290 FRANCE	889894020090 SINGAPORE EX
1	INLAY 2K ASSY	42390227452	42390227482	42390227482	42390227482
2	IRON LED ASSY	42390227453	42390227453	42390227453	42390227453
3	MS LED HOLDER	42390227454	42390227454	42390227454	42390227454
4	HOUSING PRINTED	42390227455	42390227483	42390227483	42390227483
5	TRIGGER	42390227456	42390227484	42390227484	42390227484
6	HOSE CORD ASSY	42390227457	42390227485	42390227485	42390227485
7	CHASSIS	42390227458	42390227458	42390227458	42390227458
8	SOLEPLATE ASSEMBLY	42390227459	42390227459	42390227459	42390227459
9	HOUSING CAP	42390227460	42390227460	42390227460	42390227460
*10	WATER TANK ASSY (PRINTED)	42390227461	42390227486	42390227486	42390227486
11	FRONT LOCK BRACKET ASSY	42390227462	42390227462	42390227462	42390227462
12	FRONT LOCK SLIDER ASSY	42390227463	42390227487	42390227487	42390227487
13	TRAY ASSY	42390227464	42390227488	42390227488	42390227488
14	RINSE CAP ASSY	42390227465	42390227489	42390227489	42390227489
15	RINSE BUSH ASSY	42390227466	42390227466	42390227466	42390227466
16	TANK CATCH	42390227467	42390227467	42390227467	42390227467
17	SPACER TOP	42390227468	42390227468	42390227468	42390227468
18	INOX CLAMP	42390227469	42390227469	42390227469	42390227469
19	PUMP ASSY	42390227470	42390227470	42390227470	42390227470
20	BOILER ASSEMBLY	42390227471	42390227471	42390227471	42390227471
21	SPACER BOTTOM	42390227472	42390227472	42390227472	42390227472
22	EVALVE	42390227473	42390227473	42390227473	42390227473
23	STAND TOP	42390227474	42390227519	42390227519	42390227519
24	INLET COUPLING SEAL	42390227475	42390227475	42390227475	42390227475
25	INLET COUPLING ASSY	42390227476	42390227490	42390227490	42390227490
26	HALL SENSOR ASSY	42390227477	42390227477	42390227477	42390227477
27	STAND BOTTOM ASSY	42390227478	42390227491	42390227491	42390227491
28	POWERBOARD PCBA	42390227479	42390227479	42390227479	42390227479
29	BUTTON ASSY	42390227480	42390227480	42390227480	42390227480
30	MAINS CORD ASSY	42390227481	42390227481	42390227481	42390227481

Notes: * Option for CRP

Service Lists

POS	DESCRIPTION	GC8940/20	GC8940/20	GC8942/20	GC8942/20
		889894020180	889894020400	889894220010	889894220220
		IBERIA	EEU	BENELUX	GERMANY
1	INLAY 2K ASSY	42390227482I	42390227482I	42390227482I	42390227482I
2	IRON LED ASSY	42390227453I	42390227453I	42390227453I	42390227453I
3	MS LED HOLDER	42390227454I	42390227454I	42390227454I	42390227454I
4	HOUSING PRINTED	42390227483I	42390227483I	42390227483I	42390227483I
5	TRIGGER	42390227484I	42390227484I	42390227484I	42390227484I
6	HOSE CORD ASSY	42390227485I	42390227485I	42390227485I	42390227485I
7	CHASSIS	42390227458I	42390227458I	42390227458I	42390227458I
8	SOLEPLATE ASSEMBLY	42390227459I	42390227459I	42390227459I	42390227459I
9	HOUSING CAP	42390227460I	42390227460I	42390227460I	42390227460I
*10	WATER TANK ASSY (PRINTED)	42390227486I	42390227486I	42390227486I	42390227486I
11	FRONT LOCK BRACKET ASSY	42390227462I	42390227462I	42390227462I	42390227462I
12	FRONT LOCK SLIDER ASSY	42390227487I	42390227487I	42390227487I	42390227487I
13	TRAY ASSY	42390227488I	42390227488I	42390227517I	42390227517I
14	RINSE CAP ASSY	42390227489I	42390227489I	42390227489I	42390227489I
15	RINSE BUSH ASSY	42390227466I	42390227466I	42390227466I	42390227466I
16	TANK CATCH	42390227467I	42390227467I	42390227467I	42390227467I
17	SPACER TOP	42390227468I	42390227468I	42390227468I	42390227468I
18	INOX CLAMP	42390227469I	42390227469I	42390227469I	42390227469I
19	PUMP ASSY	42390227470I	42390227470I	42390227470I	42390227470I
20	BOILER ASSEMBLY	42390227471I	42390227471I	42390227471I	42390227471I
21	SPACER BOTTOM	42390227472I	42390227472I	42390227472I	42390227472I
22	EVALVE	42390227473I	42390227473I	42390227473I	42390227473I
23	STAND TOP	42390227519I	42390227519I	42390227519I	42390227519I
24	INLET COUPLING SEAL	42390227475I	42390227475I	42390227475I	42390227475I
25	INLET COUPLING ASSY	42390227490I	42390227490I	42390227490I	42390227490I
26	HALL SENSOR ASSY	42390227477I	42390227477I	42390227477I	42390227477I
27	STAND BOTTOM ASSY	42390227491I	42390227491I	42390227491I	42390227491I
28	POWERBOARD PCBA	42390227479I	42390227479I	42390227479I	42390227479I
29	BUTTON ASSY	42390227480I	42390227480I	42390227480I	42390227480I
30	MAINS CORD ASSY	42390227481I	42390227481I	42390227481I	42390227481I

Notes: * Option for CRP

Service Lists

POS	DESCRIPTION	GC8942/20	GC8942/20	GC8942/26	GC8950/30
		889894220290	889894220380	889894226150	889895030010
		FRANCE	ITALY	UK	BENELUX
1	INLAY 2K ASSY	42390227482I	42390227482I	42390227482I	42390227492I
2	IRON LED ASSY	42390227453I	42390227453I	42390227453I	42390227453I
3	MS LED HOLDER	42390227454I	42390227454I	42390227454I	42390227454I
4	HOUSING PRINTED	42390227483I	42390227483I	42390227483I	42390227493I
5	TRIGGER	42390227484I	42390227484I	42390227484I	42390227494I
6	HOSE CORD ASSY	42390227485I	42390227485I	42390227485I	42390227495I
7	CHASSIS	42390227458I	42390227458I	42390227458I	42390227458I
8	SOLEPLATE ASSEMBLY	42390227459I	42390227459I	42390227459I	42390227459I
9	HOUSING CAP	42390227460I	42390227460I	42390227460I	42390227460I
*10	WATER TANK ASSY (PRINTED)	42390227486I	42390227486I	42390227486I	42390227496I
11	FRONT LOCK BRACKET ASSY	42390227462I	42390227462I	42390227462I	42390227462I
12	FRONT LOCK SLIDER ASSY	42390227487I	42390227487I	42390227487I	42390227497I
13	TRAY ASSY	42390227517I	42390227517I	42390227517I	42390227498I
14	RINSE CAP ASSY	42390227489I	42390227489I	42390227489I	42390227499I
15	RINSE BUSH ASSY	42390227466I	42390227466I	42390227466I	42390227500I
16	TANK CATCH	42390227467I	42390227467I	42390227467I	42390227467I
17	SPACER TOP	42390227468I	42390227468I	42390227468I	42390227468I
18	INOX CLAMP	42390227469I	42390227469I	42390227469I	42390227469I
19	PUMP ASSY	42390227470I	42390227470I	42390227470I	42390227470I
20	BOILER ASSEMBLY	42390227471I	42390227471I	42390227471I	42390227471I
21	SPACER BOTTOM	42390227472I	42390227472I	42390227472I	42390227472I
22	EVALVE	42390227473I	42390227473I	42390227473I	42390227473I
23	STAND TOP	42390227519I	42390227519I	42390227519I	42390227520I
24	INLET COUPLING SEAL	42390227475I	42390227475I	42390227475I	42390227475I
25	INLET COUPLING ASSY	42390227490I	42390227490I	42390227490I	42390227501I
26	HALL SENSOR ASSY	42390227477I	42390227477I	42390227477I	42390227477I
27	STAND BOTTOM ASSY	42390227491I	42390227491I	42390227491I	42390227502I
28	POWERBOARD PCBA	42390227479I	42390227479I	42390227479I	42390227479I
29	BUTTON ASSY	42390227480I	42390227480I	42390227480I	42390227480I
30	MAINS CORD ASSY	42390227481I	42390227481I	42390227516I	42390227481I

Notes: * Option for CRP

Service Lists

POS	DESCRIPTION	GC8950/30	GC8950/30	GC8950/30	GC8950/30
		889895030040	889895030220	889895030290	889895030300
		TURKEY	GERMANY	FRANCE	EEU
1	INLAY 2K ASSY	42390227492I	42390227492I	42390227492I	42390227492I
2	IRON LED ASSY	42390227453I	42390227453I	42390227453I	42390227453I
3	MS LED HOLDER	42390227454I	42390227454I	42390227454I	42390227454I
4	HOUSING PRINTED	42390227493I	42390227493I	42390227493I	42390227493I
5	TRIGGER	42390227494I	42390227494I	42390227494I	42390227494I
6	HOSE CORD ASSY	42390227495I	42390227495I	42390227495I	42390227495I
7	CHASSIS	42390227458I	42390227458I	42390227458I	42390227458I
8	SOLEPLATE ASSEMBLY	42390227459I	42390227459I	42390227459I	42390227459I
9	HOUSING CAP	42390227460I	42390227460I	42390227460I	42390227460I
*10	WATER TANK ASSY (PRINTED)	42390227496I	42390227496I	42390227496I	42390227496I
11	FRONT LOCK BRACKET ASSY	42390227462I	42390227462I	42390227462I	42390227462I
12	FRONT LOCK SLIDER ASSY	42390227497I	42390227497I	42390227497I	42390227497I
13	TRAY ASSY	42390227498I	42390227498I	42390227498I	42390227498I
14	RINSE CAP ASSY	42390227499I	42390227499I	42390227499I	42390227499I
15	RINSE BUSH ASSY	42390227500I	42390227500I	42390227500I	42390227500I
16	TANK CATCH	42390227467I	42390227467I	42390227467I	42390227467I
17	SPACER TOP	42390227468I	42390227468I	42390227468I	42390227468I
18	INOX CLAMP	42390227469I	42390227469I	42390227469I	42390227469I
19	PUMP ASSY	42390227470I	42390227470I	42390227470I	42390227470I
20	BOILER ASSEMBLY	42390227471I	42390227471I	42390227471I	42390227471I
21	SPACER BOTTOM	42390227472I	42390227472I	42390227472I	42390227472I
22	EVALVE	42390227473I	42390227473I	42390227473I	42390227473I
23	STAND TOP	42390227520I	42390227520I	42390227520I	42390227520I
24	INLET COUPLING SEAL	42390227475I	42390227475I	42390227475I	42390227475I
25	INLET COUPLING ASSY	42390227501I	42390227501I	42390227501I	42390227501I
26	HALL SENSOR ASSY	42390227477I	42390227477I	42390227477I	42390227477I
27	STAND BOTTOM ASSY	42390227502I	42390227502I	42390227502I	42390227502I
28	POWERBOARD PCBA	42390227479I	42390227479I	42390227479I	42390227479I
29	BUTTON ASSY	42390227480I	42390227480I	42390227480I	42390227480I
30	MAINS CORD ASSY	42390227481I	42390227481I	42390227481I	42390227481I

Notes: * Option for CRP

Service Lists

POS	DESCRIPTION	GC8952/30	GC8952/30	GC8952/30	GC8952/30
		889895230090 SINGAPORE EX	889895230180 IBERIA	889895230220 DENMARK	889895230400 EEU
1	INLAY 2K ASSY	42390227492I	42390227492I	42390227492I	42390227492I
2	IRON LED ASSY	42390227453I	42390227453I	42390227453I	42390227453I
3	MS LED HOLDER	42390227454I	42390227454I	42390227454I	42390227454I
4	HOUSING PRINTED	42390227493I	42390227493I	42390227493I	42390227493I
5	TRIGGER	42390227494I	42390227494I	42390227494I	42390227494I
6	HOSE CORD ASSY	42390227495I	42390227495I	42390227495I	42390227495I
7	CHASSIS	42390227458I	42390227458I	42390227458I	42390227458I
8	SOLEPLATE ASSEMBLY	42390227459I	42390227459I	42390227459I	42390227459I
9	HOUSING CAP	42390227460I	42390227460I	42390227460I	42390227460I
*10	WATER TANK ASSY (PRINTED)	42390227496I	42390227496I	42390227496I	42390227496I
11	FRONT LOCK BRACKET ASSY	42390227462I	42390227462I	42390227462I	42390227462I
12	FRONT LOCK SLIDER ASSY	42390227497I	42390227497I	42390227497I	42390227497I
13	TRAY ASSY	42390227498I	42390227498I	42390227498I	42390227498I
14	RINSE CAP ASSY	42390227499I	42390227499I	42390227499I	42390227499I
15	RINSE BUSH ASSY	42390227500I	42390227500I	42390227500I	42390227500I
16	TANK CATCH	42390227467I	42390227467I	42390227467I	42390227467I
17	SPACER TOP	42390227468I	42390227468I	42390227468I	42390227468I
18	INOX CLAMP	42390227469I	42390227469I	42390227469I	42390227469I
19	PUMP ASSY	42390227470I	42390227470I	42390227470I	42390227470I
20	BOILER ASSEMBLY	42390227471I	42390227471I	42390227471I	42390227471I
21	SPACER BOTTOM	42390227472I	42390227472I	42390227472I	42390227472I
22	EVALVE	42390227473I	42390227473I	42390227473I	42390227473I
23	STAND TOP	42390227520I	42390227520I	42390227520I	42390227520I
24	INLET COUPLING SEAL	42390227475I	42390227475I	42390227475I	42390227475I
25	INLET COUPLING ASSY	42390227501I	42390227501I	42390227501I	42390227501I
26	HALL SENSOR ASSY	42390227477I	42390227477I	42390227477I	42390227477I
27	STAND BOTTOM ASSY	42390227502I	42390227502I	42390227502I	42390227502I
28	POWERBOARD PCBA	42390227479I	42390227479I	42390227479I	42390227479I
29	BUTTON ASSY	42390227480I	42390227480I	42390227480I	42390227480I
30	MAINS CORD ASSY	42390227481I	42390227481I	42390227481I	42390227481I

Notes: * Option for CRP

Service Lists

POS	DESCRIPTION	GC8960/40	GC8960/40	GC8962/40	GC8962/40
		889896040010	889896040290	889896240010	889896240040
		BENELUX	FRANCE	BENELUX	TURKEY
1	INLAY 2K ASSY	42390227503I	42390227503I	42390227503I	42390227503I
2	IRON LED ASSY	42390227453I	42390227453I	42390227453I	42390227453I
3	MS LED HOLDER	42390227454I	42390227454I	42390227454I	42390227454I
4	HOUSING PRINTED	42390227504I	42390227504I	42390227504I	42390227504I
5	TRIGGER	42390227505I	42390227505I	42390227505I	42390227505I
6	HOSE CORD ASSY	42390227506I	42390227506I	42390227506I	42390227506I
7	CHASSIS	42390227458I	42390227458I	42390227458I	42390227458I
8	SOLEPLATE ASSEMBLY	42390227507I	42390227507I	42390227507I	42390227507I
9	HOUSING CAP	42390227460I	42390227460I	42390227460I	42390227460I
*10	WATER TANK ASSY (PRINTED)	42390227508I	42390227508I	42390227508I	42390227508I
11	FRONT LOCK BRACKET ASSY	42390227462I	42390227462I	42390227462I	42390227462I
12	FRONT LOCK SLIDER ASSY	42390227509I	42390227509I	42390227509I	42390227509I
13	TRAY ASSY	42390227510I	42390227510I	42390227515I	42390227515I
14	RINSE CAP ASSY	42390227511I	42390227511I	42390227511I	42390227511I
15	RINSE BUSH ASSY	42390227512I	42390227512I	42390227512I	42390227512I
16	TANK CATCH	42390227467I	42390227467I	42390227467I	42390227467I
17	SPACER TOP	42390227468I	42390227468I	42390227468I	42390227468I
18	INOX CLAMP	42390227469I	42390227469I	42390227469I	42390227469I
19	PUMP ASSY	42390227470I	42390227470I	42390227470I	42390227470I
20	BOILER ASSEMBLY	42390227471I	42390227471I	42390227471I	42390227471I
21	SPACER BOTTOM	42390227472I	42390227472I	42390227472I	42390227472I
22	EVALVE	42390227473I	42390227473I	42390227473I	42390227473I
23	STAND TOP	42390227474I	42390227474I	42390227474I	42390227474I
24	INLET COUPLING SEAL	42390227475I	42390227475I	42390227475I	42390227475I
25	INLET COUPLING ASSY	42390227476I	42390227476I	42390227476I	42390227476I
26	HALL SENSOR ASSY	42390227477I	42390227477I	42390227477I	42390227477I
27	STAND BOTTOM ASSY	42390227513I	42390227513I	42390227513I	42390227513I
28	POWERBOARD PCBA	42390227479I	42390227479I	42390227479I	42390227479I
29	BUTTON ASSY	42390227514I	42390227514I	42390227514I	42390227514I
30	MAINS CORD ASSY	42390227481I	42390227481I	42390227481I	42390227481I

Notes: * Option for CRP

Service Lists

POS	DESCRIPTION	GC8962/40	GC8962/40	GC8962/40	GC8962/40
		889896240090 SINGAPORE EX	889896240180 IBERIA	889896240290 FRANCE	889896240300 EEU
1	INLAY 2K ASSY	42390227503I	42390227503I	42390227503I	42390227503I
2	IRON LED ASSY	42390227453I	42390227453I	42390227453I	42390227453I
3	MS LED HOLDER	42390227454I	42390227454I	42390227454I	42390227454I
4	HOUSING PRINTED	42390227504I	42390227504I	42390227504I	42390227504I
5	TRIGGER	42390227505I	42390227505I	42390227505I	42390227505I
6	HOSE CORD ASSY	42390227506I	42390227506I	42390227506I	42390227506I
7	CHASSIS	42390227458I	42390227458I	42390227458I	42390227458I
8	SOLEPLATE ASSEMBLY	42390227507I	42390227507I	42390227507I	42390227507I
9	HOUSING CAP	42390227460I	42390227460I	42390227460I	42390227460I
*10	WATER TANK ASSY (PRINTED)	42390227508I	42390227508I	42390227508I	42390227508I
11	FRONT LOCK BRACKET ASSY	42390227462I	42390227462I	42390227462I	42390227462I
12	FRONT LOCK SLIDER ASSY	42390227509I	42390227509I	42390227509I	42390227509I
13	TRAY ASSY	42390227515I	42390227515I	42390227515I	42390227515I
14	RINSE CAP ASSY	42390227511I	42390227511I	42390227511I	42390227511I
15	RINSE BUSH ASSY	42390227512I	42390227512I	42390227512I	42390227512I
16	TANK CATCH	42390227467I	42390227467I	42390227467I	42390227467I
17	SPACER TOP	42390227468I	42390227468I	42390227468I	42390227468I
18	INOX CLAMP	42390227469I	42390227469I	42390227469I	42390227469I
19	PUMP ASSY	42390227470I	42390227470I	42390227470I	42390227470I
20	BOILER ASSEMBLY	42390227471I	42390227471I	42390227471I	42390227471I
21	SPACER BOTTOM	42390227472I	42390227472I	42390227472I	42390227472I
22	EVALVE	42390227473I	42390227473I	42390227473I	42390227473I
23	STAND TOP	42390227474I	42390227474I	42390227474I	42390227474I
24	INLET COUPLING SEAL	42390227475I	42390227475I	42390227475I	42390227475I
25	INLET COUPLING ASSY	42390227476I	42390227476I	42390227476I	42390227476I
26	HALL SENSOR ASSY	42390227477I	42390227477I	42390227477I	42390227477I
27	STAND BOTTOM ASSY	42390227513I	42390227513I	42390227513I	42390227513I
28	POWERBOARD PCBA	42390227479I	42390227479I	42390227479I	42390227479I
29	BUTTON ASSY	42390227514I	42390227514I	42390227514I	42390227514I
30	MAINS CORD ASSY	42390227481I	42390227481I	42390227481I	42390227481I

Notes: * Option for CRP

Service Lists

POS	DESCRIPTION	GC8962/40	GC8962/46	GC8962/46	GC8930/10
		889896240400	889896246150	889896246500	889893000090
		EEU	UK	SINGAPORE	POLAND
1	INLAY 2K ASSY	42390227503I	42390227503I	42390227503I	42390227452I
2	IRON LED ASSY	42390227453I	42390227453I	42390227453I	42390227453I
3	MS LED HOLDER	42390227454I	42390227454I	42390227454I	42390227454I
4	HOUSING PRINTED	42390227504I	42390227504I	42390227504I	42390227455I
5	TRIGGER	42390227505I	42390227505I	42390227505I	42390227456I
6	HOSE CORD ASSY	42390227506I	42390227506I	42390227506I	42390227457I
7	CHASSIS	42390227458I	42390227458I	42390227458I	42390227458I
8	SOLEPLATE ASSEMBLY	42390227507I	42390227507I	42390227507I	42390227459I
9	HOUSING CAP	42390227460I	42390227460I	42390227460I	42390227460I
* 10	WATER TANK ASSY (PRINTED)	42390227508I	42390227508I	42390227508I	42390227461I
11	FRONT LOCK BRACKET ASSY	42390227462I	42390227462I	42390227462I	42390227462I
12	FRONT LOCK SLIDER ASSY	42390227509I	42390227509I	42390227509I	42390227463I
13	TRAY ASSY	42390227515I	42390227515I	42390227515I	42390227464I
14	RINSE CAP ASSY	42390227511I	42390227511I	42390227511I	42390227465I
15	RINSE BUSH ASSY	42390227512I	42390227512I	42390227512I	42390227512I
16	TANK CATCH	42390227467I	42390227467I	42390227467I	42390227467I
17	SPACER TOP	42390227468I	42390227468I	42390227468I	42390227468I
18	INOX CLAMP	42390227469I	42390227469I	42390227469I	42390227469I
19	PUMP ASSY	42390227470I	42390227470I	42390227470I	42390227470I
20	BOILER ASSEMBLY	42390227471I	42390227471I	42390227471I	42390227471I
21	SPACER BOTTOM	42390227472I	42390227472I	42390227472I	42390227472I
22	EVALVE	42390227473I	42390227473I	42390227473I	42390227473I
23	STAND TOP	42390227474I	42390227474I	42390227474I	42390227474I
24	INLET COUPLING SEAL	42390227475I	42390227475I	42390227475I	42390227475I
25	INLET COUPLING ASSY	42390227476I	42390227476I	42390227476I	42390227476I
26	HALL SENSOR ASSY	42390227477I	42390227477I	42390227477I	42390227477I
27	STAND BOTTOM ASSY	42390227513I	42390227513I	42390227513I	42390227478I
28	POWERBOARD PCBA	42390227479I	42390227479I	42390227479I	42390227479I
29	BUTTON ASSY	42390227514I	42390227514I	42390227514I	42390227480I
30	MAINS CORD ASSY	42390227481I	42390227516I	42390227516I	42390227481I

Notes: * Option for CRP

Service Lists

POS	DESCRIPTION	GC8930/10	GC8930/10	GC8930/11	GC8942/20
		889893010300	889893010400	889893011160	889894220300
		EEU	EEU	SWITZERLAND	EEU
1	INLAY 2K ASSY	42390227452I	42390227452I	42390227452I	42390227482I
2	IRON LED ASSY	42390227453I	42390227453I	42390227453I	42390227453I
3	MS LED HOLDER	42390227454I	42390227454I	42390227454I	42390227454I
4	HOUSING PRINTED	42390227455I	42390227455I	42390227455I	42390227483I
5	TRIGGER	42390227456I	42390227456I	42390227456I	42390227484I
6	HOSE CORD ASSY	42390227457I	42390227457I	42390227457I	42390227485I
7	CHASSIS	42390227458I	42390227458I	42390227458I	42390227458I
8	SOLEPLATE ASSEMBLY	42390227459I	42390227459I	42390227459I	42390227459I
9	HOUSING CAP	42390227460I	42390227460I	42390227460I	42390227460I
10*	WATER TANK ASSY (PRINTED)	42390227461I	42390227461I	42390227461I	42390227486I
11	FRONT LOCK BRACKET ASSY	42390227462I	42390227462I	42390227462I	42390227462I
12	FRONT LOCK SLIDER ASSY	42390227463I	42390227463I	42390227463I	42390227487I
13	TRAY ASSY	42390227464I	42390227464I	42390227464I	42390227517I
14	RINSE CAP ASSY	42390227465I	42390227465I	42390227465I	42390227489I
15	RINSE BUSH ASSY	42390227512I	42390227512I	42390227512I	42390227466I
16	TANK CATCH	42390227467I	42390227467I	42390227467I	42390227467I
17	SPACER TOP	42390227468I	42390227468I	42390227468I	42390227468I
18	INOX CLAMP	42390227469I	42390227469I	42390227469I	42390227469I
19	PUMP ASSY	42390227470I	42390227470I	42390227470I	42390227470I
20	BOILER ASSEMBLY	42390227471I	42390227471I	42390227471I	42390227471I
21	SPACER BOTTOM	42390227472I	42390227472I	42390227472I	42390227472I
22	EVALVE	42390227473I	42390227473I	42390227473I	42390227473I
23	STAND TOP	42390227474I	42390227474I	42390227474I	42390227519I
24	INLET COUPLING SEAL	42390227475I	42390227475I	42390227475I	42390227475I
25	INLET COUPLING ASSY	42390227476I	42390227476I	42390227476I	42390227490I
26	HALL SENSOR ASSY	42390227477I	42390227477I	42390227477I	42390227477I
27	STAND BOTTOM ASSY	42390227478I	42390227478I	42390227478I	42390227491I
28	POWERBOARD PCBA	42390227479I	42390227479I	42390227479I	42390227479I
29	BUTTON ASSY	42390227480I	42390227480I	42390227480I	42390227480I
30	MAINS CORD ASSY	42390227481I	42390227481I	42390227556I	42390227481I

Notes: * Option for CRP

Service Lists

POS	DESCRIPTION	GC8942/20	GC8942/21	GC8950/31	GC8942/20
		889894220400 EEU	889894221160 SWITZERLAND	889895031160 SWITZERLAND	889894220040 TURKEY
1	INLAY 2K ASSY	423902274821	423902274821	423902274921	423902274821
2	IRON LED ASSY	423902274531	423902274531	423902274531	423902274531
3	MS LED HOLDER	423902274541	423902274541	423902274541	423902274541
4	HOUSING PRINTED	423902274831	423902274831	423902274931	423902274831
5	TRIGGER	423902274841	423902274841	423902274941	423902274841
6	HOSE CORD ASSY	423 02274851	423902274851	423902274951	423902274851
7	CHASSIS	423902274581	423902274581	423902274581	423902274581
8	SOLEPLATE ASSEMBLY	423902274591	423902274591	423902274591	423902274591
9	HOUSING CAP	423902274601	423902274601	423902274601	423902274601
10*	WATER TANK ASSY PRTED	423902274861	423902274861	423902274961	423902274601
11	FRONT LOCK BRACKET ASSY	423902274621	423902274621	423902274621	423902274621
12	FRONT LOCK SLIDER ASSY	423902274871	423902274871	423902274971	423902274871
13	TRAY ASSY	423902275171	423902275171	423902274981	423902275171
14	RINSE CAP ASSY	423902274891	423902274891	423902274991	423902274891
15	RINSE BUSH ASSY	423902274661	423902274661	423902275001	423902274661
16	TANK CATCH	423902274671	423902274671	423902274671	423902274671
17	SPACER TOP	423902274681	423902274681	423902274681	423902274681
18	INOX CLAMP	423902274691	423902274691	423902274691	423902274691
19	PUMP ASSY	423902274701	423902274701	423902274701	423902274701
20	BOILER ASSEMBLY	423902274711	423902274711	423902274711	423902274711
21	SPACER BOTTOM	423902274721	423902274721	423902274721	423902274721
22	EVALVE	423902274731	423902274731	423902274731	423902274731
23	STAND TOP	423902275191	423902275191	423902275201	423902275191
24	INLET COUPLING SEAL	423902274751	423902274751	423902274751	423902274751
25	INLET COUPLING ASSY	423902274901	423902274901	423902275011	423902274901
26	HALL SENSOR ASSY	423902274771	423902274771	423902274771	423902274771
27	STAND BOTTOM ASSY	423902274911	423902274911	423902275021	423902274911
28	POWERBOARD PCBA	423902274791	423902274791	423902274791	423902274791
29	BUTTON ASSY	423902274801	423902274801	423902274801	423902274801
30	MAINS CORD ASSY	423902274811	423902275561	423902275561	423902274811

Notes: * Option for CRP

Service Lists

POS	DESCRIPTION	GC8950/30	GC8962/40
		889895030400	889896240530
		EEU	AUSTRALIA
1	INLAY 2K ASSY	42390227492	42390227503
2	IRON LED ASSY	42390227453	42390227453
3	MS LED HOLDER	42390227454	42390227454
4	HOUSING PRINTED	42390227493	42390227504
5	TRIGGER	42390227494	42390227505
6	HOSE CORD ASSY	42390227495	42390227506
7	CHASSIS	42390227458	42390227458
8	SOLEPLATE ASSEMBLY	42390227459	42390227507
9	HOUSING CAP	42390227460	42390227460
10*	WATER TANK ASSY (PRINTED)	42390227496	42390227508
11	FRONT LOCK BRACKET ASSY	42390227462	42390227462
12	FRONT LOCK SLIDER ASSY	42390227497	42390227509
13	TRAY ASSY	42390227498	42390227515
14	RINSE CAP ASSY	42390227499	42390227511
15	RINSE BUSH ASSY	42390227500	42390227512
16	TANK CATCH	42390227467	42390227467
17	SPACER TOP	42390227468	42390227468
18	INOX CLAMP	42390227469	42390227469
19	PUMP ASSY	42390227470	42390227470
20	BOILER ASSEMBLY	42390227471	42390227471
21	SPACER BOTTOM	42390227472	42390227472
22	EVALVE	42390227473	42390227473
23	STAND TOP	42390227520	42390227474
24	INLET COUPLING SEAL	42390227475	42390227475
25	INLET COUPLING ASSY	42390227501	42390227476
26	HALL SENSOR ASSY	42390227477	42390227477
27	STAND BOTTOM ASSY	42390227502	42390227513
28	POWERBOARD PCBA	42390227479	42390227479
29	BUTTON ASSY	42390227480	42390227514
30	MAINS CORD ASSY	42390227481	42390227894

Notes: * Option for CRP

Service Lists

- Iron exploded view

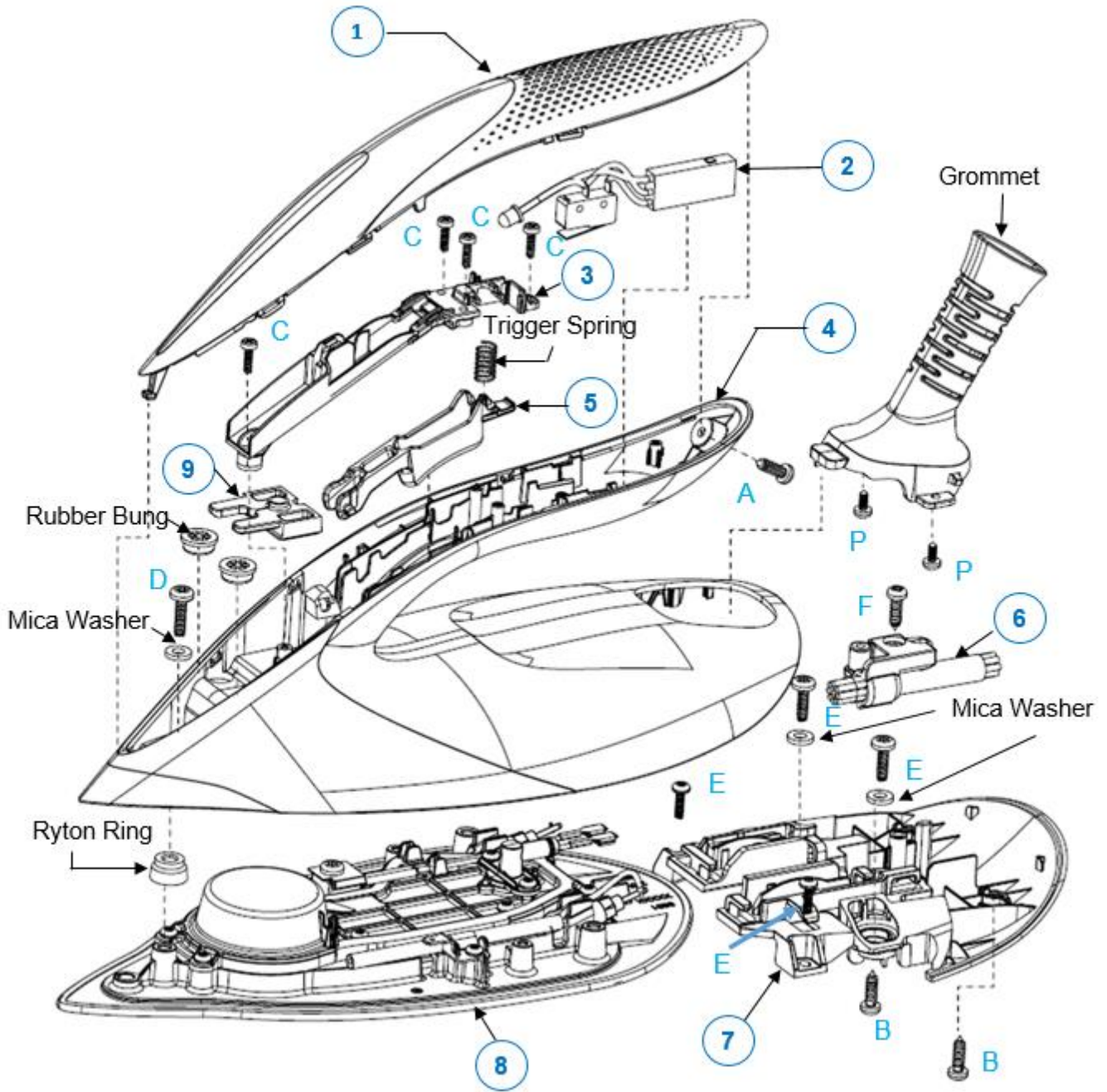

Parts without pos. number are not service item and can't be ordered.
Scale: Not to scale

Service Lists

- Stand exploded view

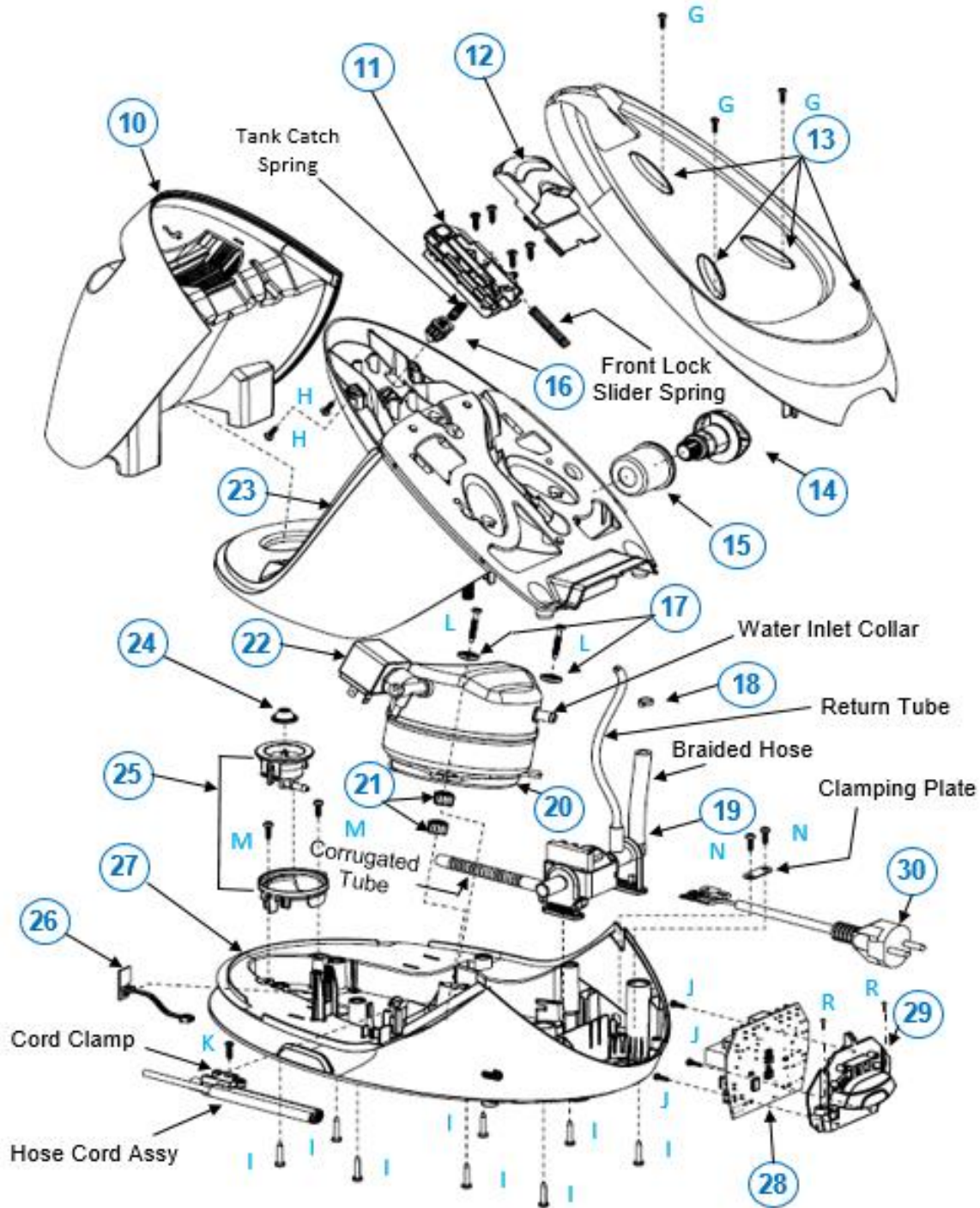

Parts without pos. number are not service item and can't be ordered.

Scale: Not to scale

Revision History

Version	Records	Author	Date
0	New release	Chong Yoke Lan	17-May-2018
1	-Update position 23 part list for GC894x & GC895x per CR033218. -Add new versions: 889894020091, 889894020181, 889894020401, 889894220221, 889894220381, 889895030041, 889895030221, 889895030301, 889895230091, 889895230181, 889895230401, 889896240041, 889896240091, 889896240181, 889896240301, 889896240401, 889896246501	Chong Yoke Lan	7-Jun-2018
2	-update Repair Instruction, Troubleshooting and Disassembly Instruction. -Add new versions: 889893010090, 889893010300, 889893010400, 889893011160, 889894220300, 889894220400, 889894221160, 889895031160	Chong Yoke Lan	19-Jul-2018
3	Add new versions: 889894220040, 889895939400	Chong Yoke Lan	29-Oct-2018
4	Update Repair Instruction Update FMT flow Add new versions: 889896240530	Chang Yoke Lan	10-Feb-2020